







INbtc033_US_CA





84B-780



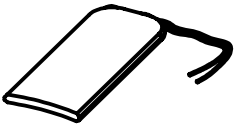









IMPORTANT, RETAIN FOR FUTURE REFERENCE: READ CAREFULLY

ASSEMBLY & INSTRUCTION MANUAL

| | |
|--|---------------|
| BOX 1-4 | A1 x 1 |
|  | |
| B1 x 4 | |
|  | |
| C1 x 2 | |
|  | |
| D1 x 2 | |
|  | |
|  | |
| Hardware Kit | |

| | |
|--|--------------|
| BOX 2-4 | A x 2 |
|  | |
| B x 2 | |
|  | |
| C x 2 | |
|  | |
| D x 2 | |
|  | |
|  | |
| Hardware Kit | |

| | |
|---|--------------|
| BOX 3-4 | A x 2 |
|  | |
| B x 2 | |
|  | |
| C x 2 | |
|  | |
| D x 2 | |
|  | |
|  | |
| Hardware Kit | |

| | |
|--|--------------|
| BOX 4-4 | A x 2 |
|  | |
| B x 2 | |
|  | |
| C x 2 | |
|  | |
| D x 2 | |
|  | |
|  | |
| Hardware Kit | |

Garden Chairs

IMPORTANT, RETAIN FOR FUTURE REFERENCE: READ CAREFULLY

Only for domestic use

Use tips:

- *Put the chair stably on a flat floor.
- *Mount the garden chairs in the shelter of the weather.
- *Stay away from open flames.
- *Don't hang anything in the structure.
- *Avoid the overload at the anchors/structure.
- *It is advised that don't stay on the chairs when there is a storm.
- *It is recommended to protect in case of strong wind or rain and in your absence.

Precautions before assembly:

- *Prepare a clean and dry mounting area.
- *Verify that the product is not damaged.
- *Check that none of the pieces are missing.

Maintenance:

- *Clean with a soft fabric.
- *Regularly remove leaves and / or water collected on the canvas.
- *Check the chair regularly.

Storage conditions:

*The fabric should be stored completely dry, in a clean and dry place to avoid the risks of mold.

Caution with the risks of pinching or cuts during assembly.

The manufacturer declines all responsibility in case of damages due to a bad installation or due to weather.

Chaises de jardin

IMPORTANT - CONSERVEZ CES INFORMATIONS POUR VOTRE CONSULTATION ULTÉRIEURE: LISEZ ATTENTIVEMENT

Seulement pour usage domestique

Conseils:

- * Placez la chaise de manière stable sur un sol plat.
- * Installez les chaises de jardin à l'abri des intempéries.
- * Restez à l'écart des flammes ouvertes.
- * Ne rien accrocher dans la structure.
- * Évitez de surcharger les extrémités de la structure
- * Il est conseillé de ne pas rester sur la chaise en cas d'orage.
- * Il est recommandé de la protéger en cas de vent fort ou de pluie et en votre absence.

Précautions avant l'assemblage:

- * Préparez une zone de montage propre et sèche.
- * Vérifiez que le produit n'est pas endommagé.
- * Vérifiez qu'aucun des morceaux ne manque.

Recommandations d'entretien:

- *Veuillez utiliser un chiffon doux pour essuyer la chaise.
- *Veuillez nettoyer régulièrement l'eau stagnante du fauteuil
- *Veuillez vérifier régulièrement la chaise pour éviter une structure lâche.

Conditions de stockage:

- *Veuillez stocker le produit dans un environnement propre et sec pour éviter tout risque de moisissure.

Veillez faire attention à ne pas être pris ou rayé par le produit lors de l'assemblage

Le fabricant n'est pas responsable des dommages causés par une mauvaise installation.

Si le fauteuil est équipé d'un dispositif de hauteur réglable avec accumulateur, seul une personne qualifiée peut remplacer ou réparer la partie de hauteur réglable du siège.

PARTS

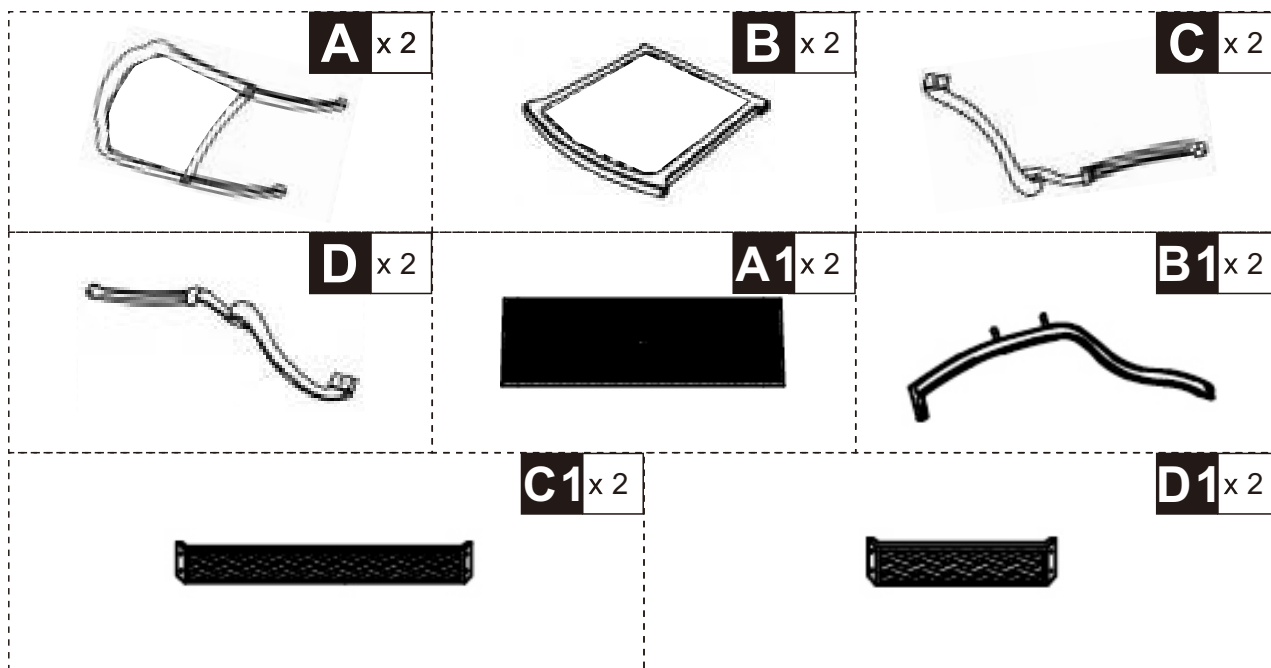

HARDWARE

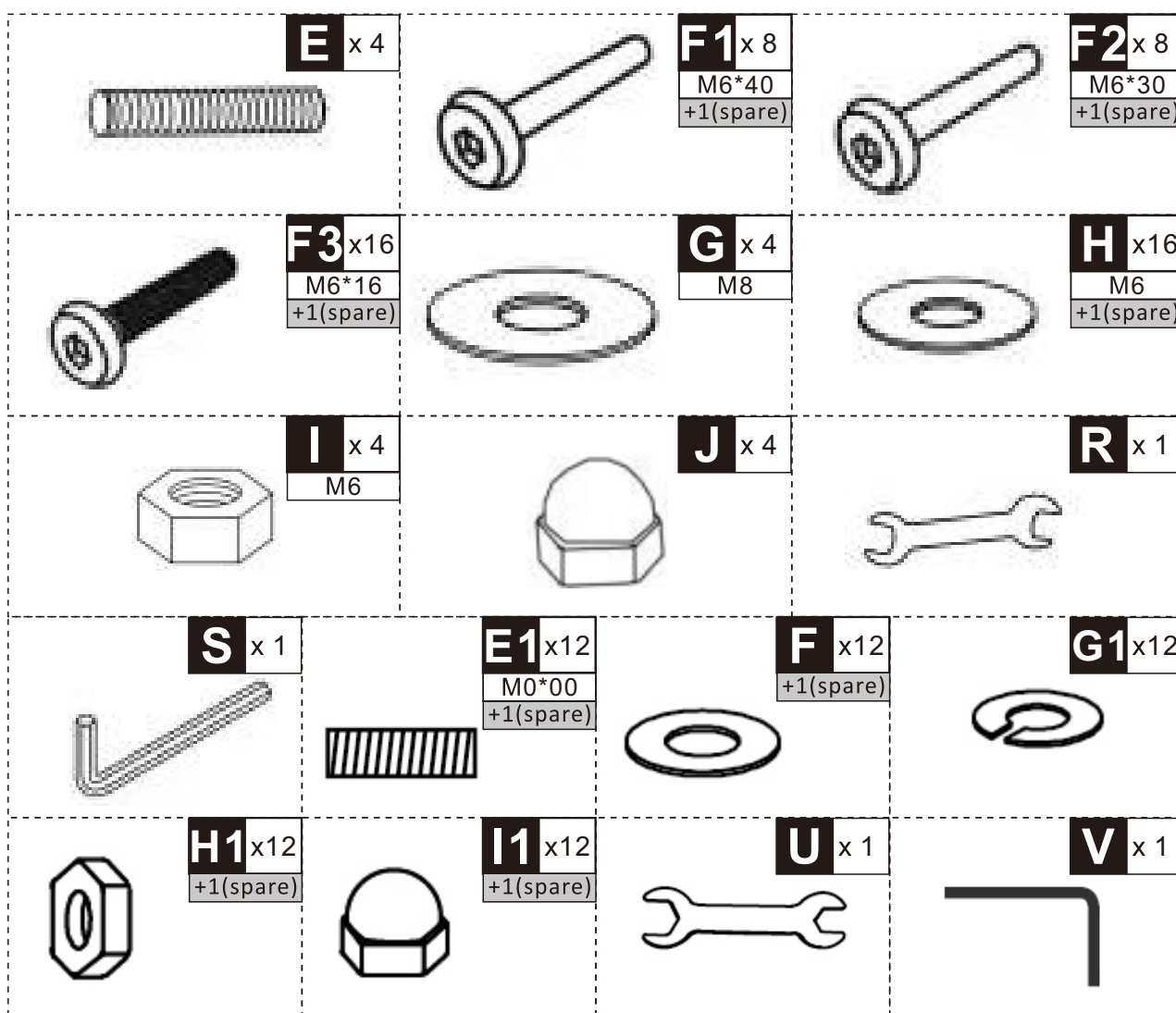

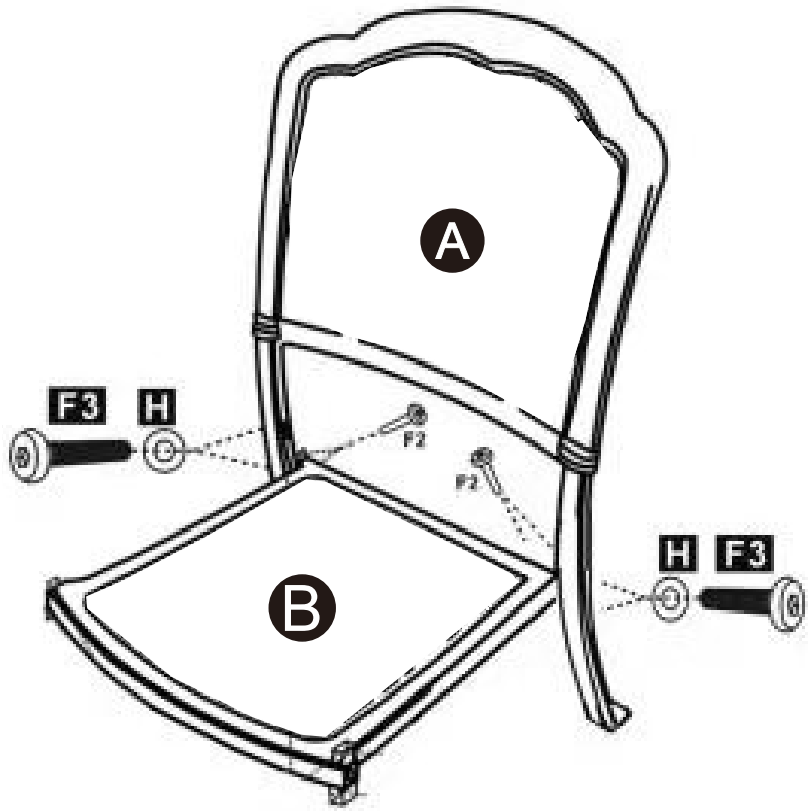
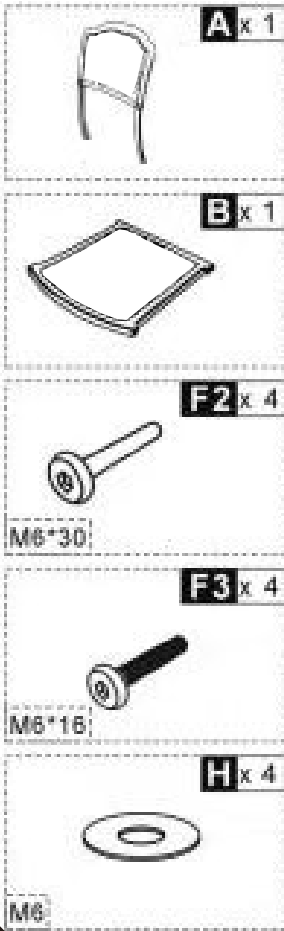

x4

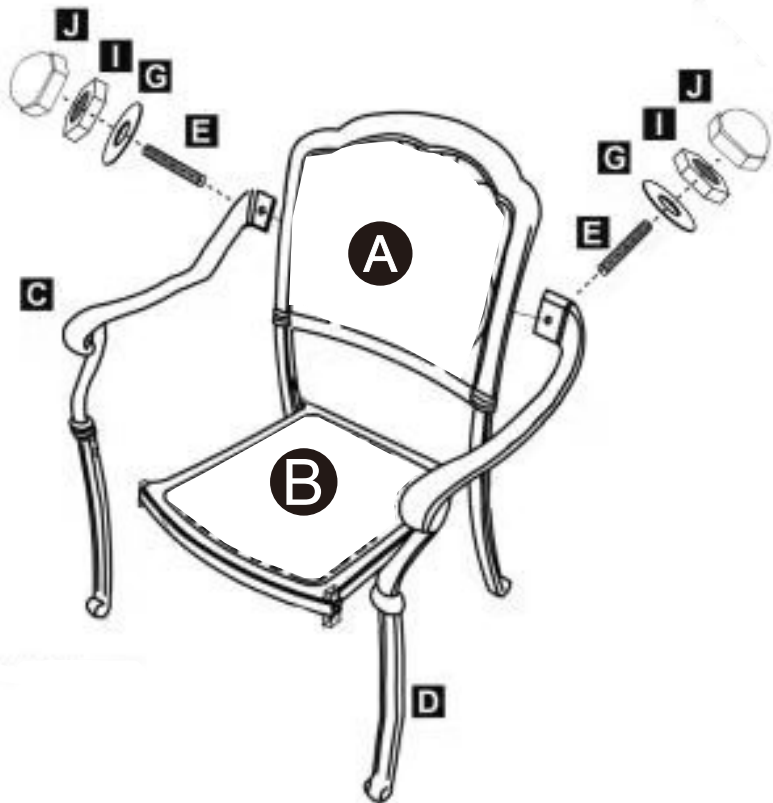
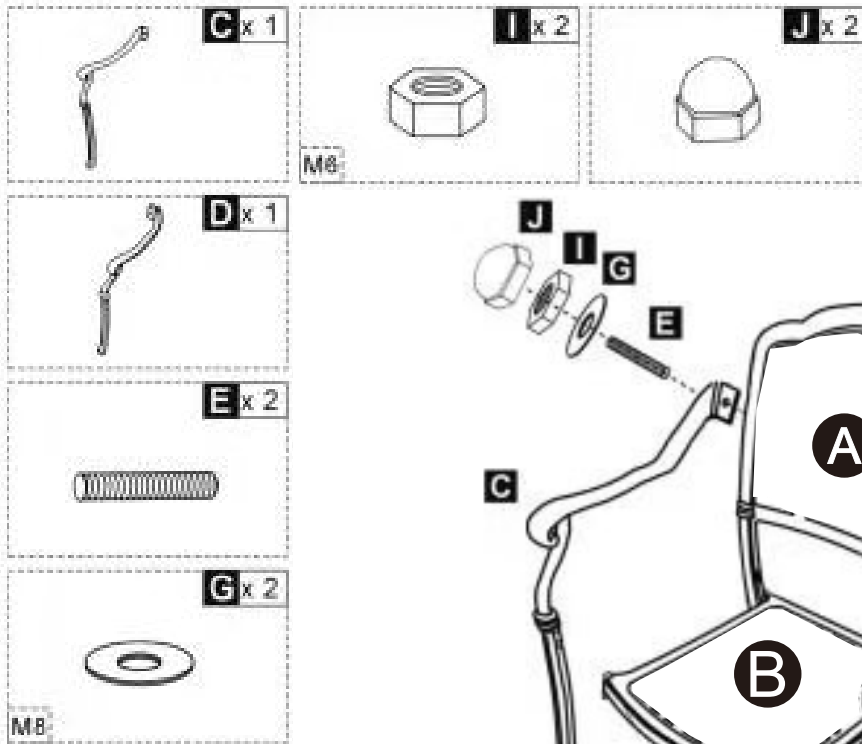

x4

F1 x 4

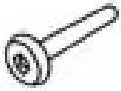

M8*40

F3 x 4



M8*16

H x 4



M8

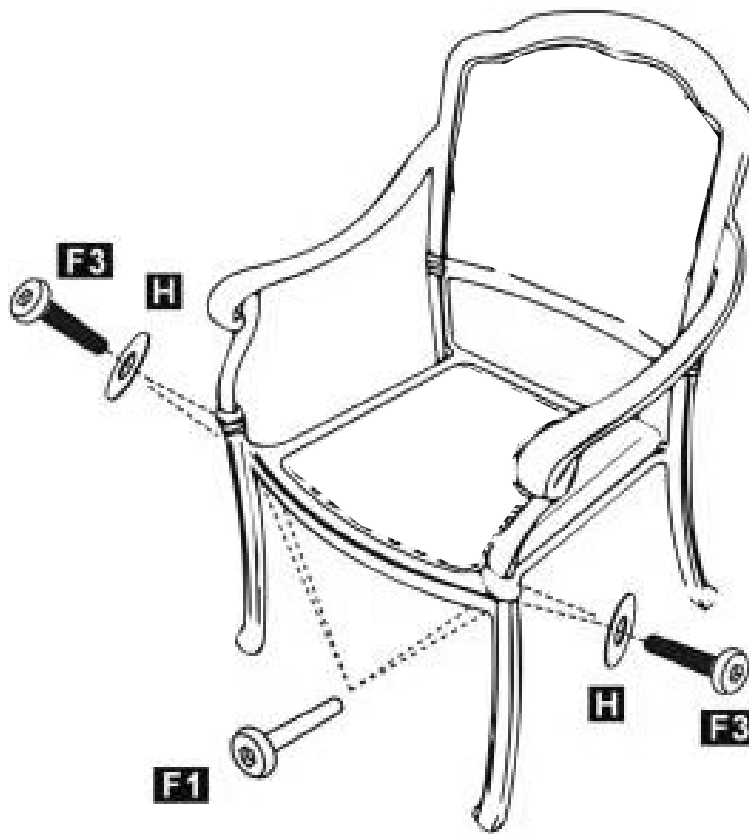

x4

