

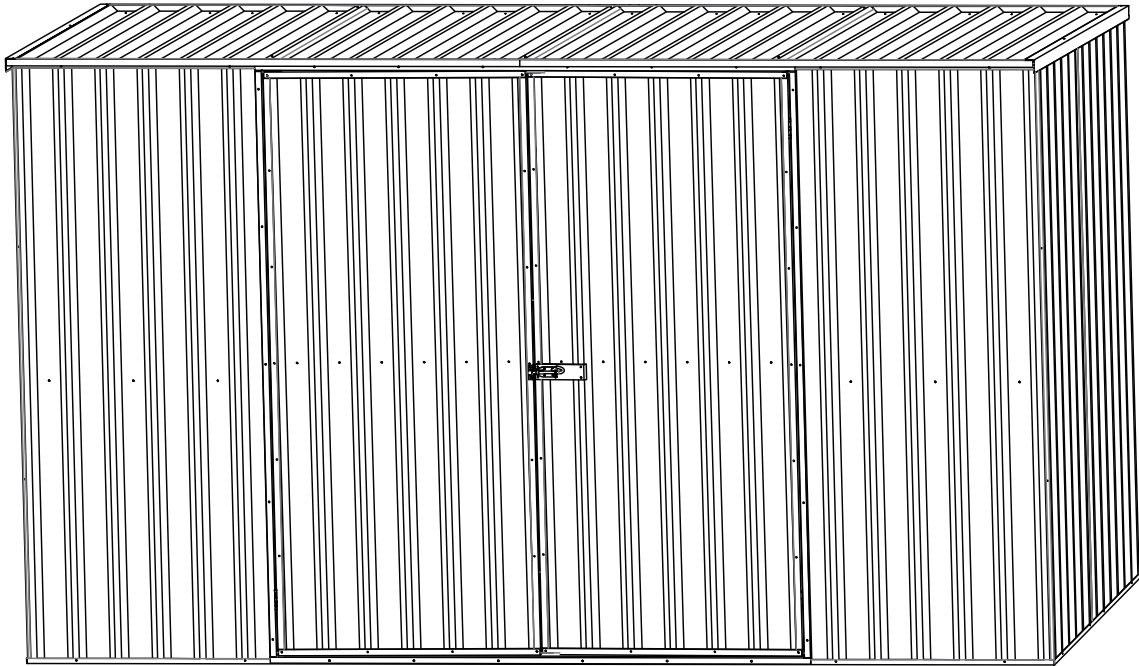

INbcb023_US





845-680

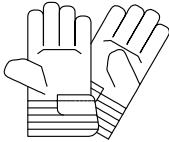

IMPORTANT, RETAIN FOR FUTURE REFERENCE: READ CAREFULLY

ASSEMBLY & INSTRUCTION MANUAL

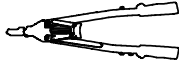
Items Required:

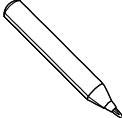
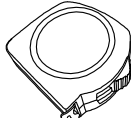
| | | | | |
|--------------|---|---|--|---|
| Tools |  |  |  |  |
| | gloves | Safety Glasses | Shoes | Riveting Gun |
| Tools |  |  |  |  |
| | Power drill | Screw drive | Pencil | Tape Measure |

- Clear a working area to allow access on 4 sides. A raised work surface will make assembly easier.
- All parts are identified so when working through the instructions page by page the diagrams show where each part is positioned.
- Many of the holes have been pre-punched, to allow fixing using self-tapping screws or rivets, where additional holes are required a drill bit is included.
- Before starting, to avoid any accidental injury, we recommend the use of gloves to protect your hands, safety glasses to protect your eyes and shoes or boots to protect your feet.
- Please keep children away from your construction site.
- Most assembly can be completed by one person, assistance may be needed when you reach the erection stage.
- Please note: Some local government authorities have rules & regulations on shed installation and you may need approval to erect this shed.

STEPS:

1. Unpack all components from the carton and lay outside your work area and check parts against the part list on the next page.
2. Refer to page "HOW PANELS ARE JOINED", the unique clipping method reduces the number of screws and rivets required and speed up assembly.
3. Work through assembly instructions Page by Page
4. When completed place shed in position and anchor securely to the ground.
5. Clean up all metal pieces, rivets and screws.

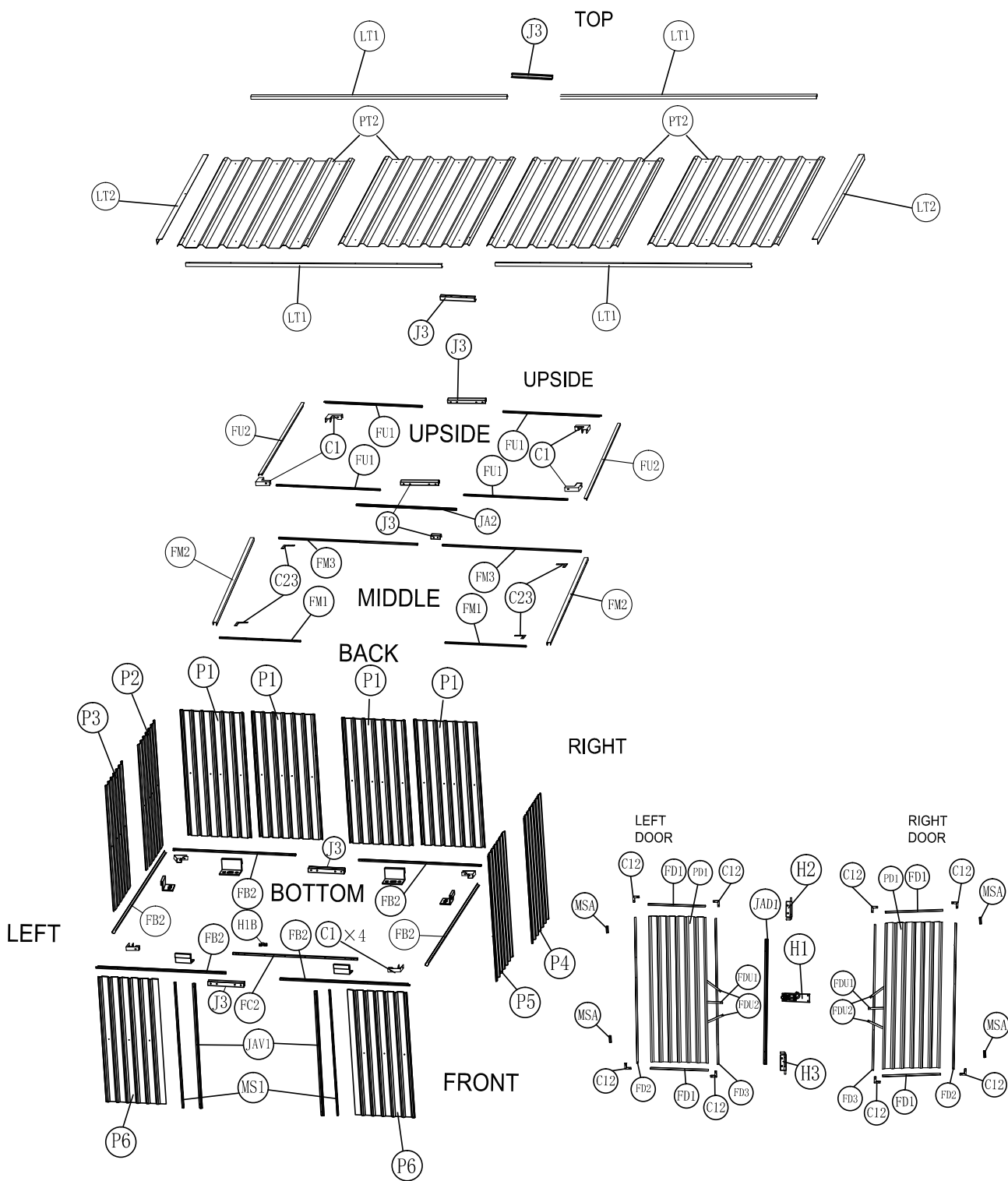

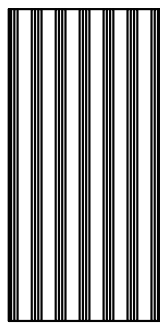
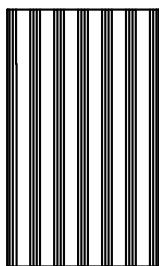
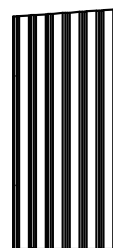
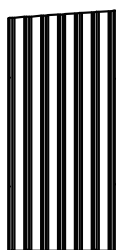
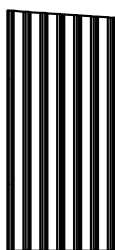
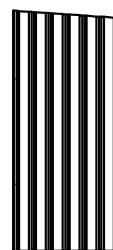
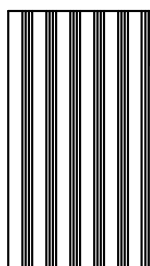
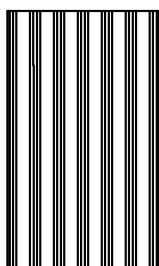
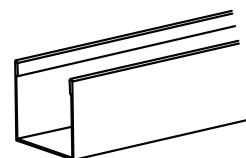
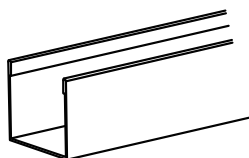
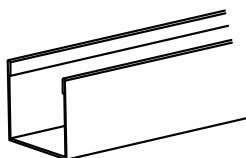
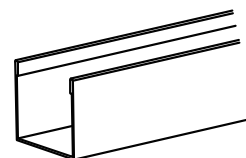
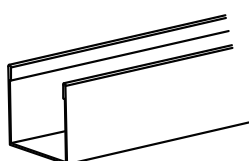
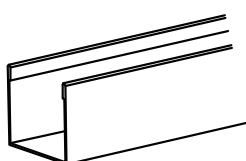
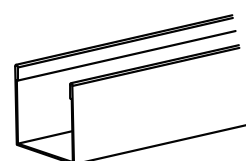
**PT2** x04**P1** x04**P2** x01**P3** x01**P4** x01**P5** x01**P6** x02**PD1** x02**FD3** x02**FU1** x04**FU2** x02**FB2** x06**FM1** x02**FM2** x02**FM3** x02

FC2 x01

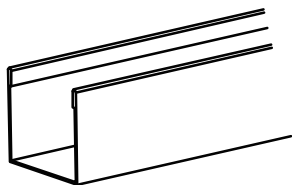

FD1 x04

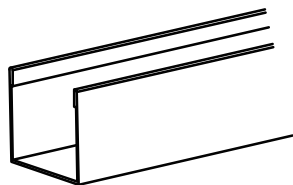

FD2 x02

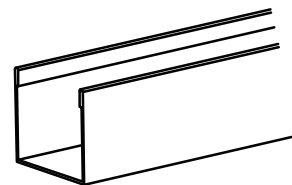

LT2 x02

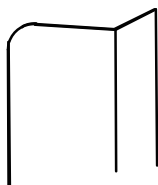

FDU1 x02

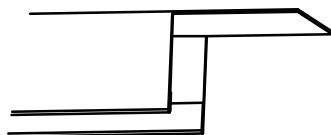

FDU2 x04

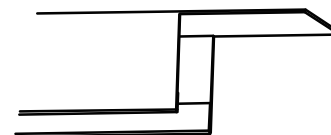

LT1 x04

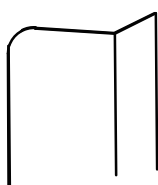

MS1 x02

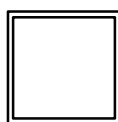

JAV1 x02

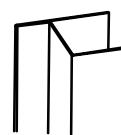



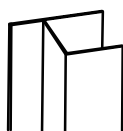



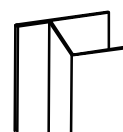



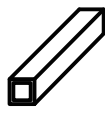

JAD1 x01

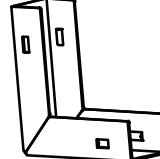
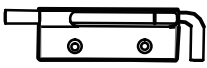
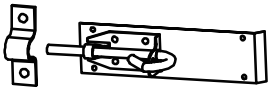
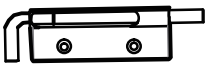

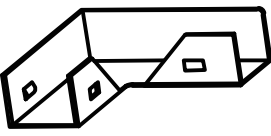
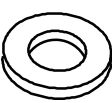
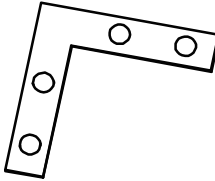
JA2 x01

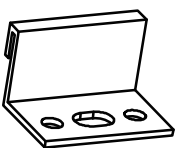
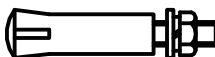
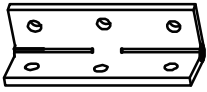

| | | | |
|---|--|--|---|
| <p>S1 x02</p>  | <p>Rust zinc block x02</p>  | <p>L1 x02</p>  | <p>L1A x12</p>  |
| <p>MSA x04</p>  | <p>J3 x05</p>  | <p>C12 x08</p>  | <p>H2 x01</p>  |
| <p>H1 x01</p>  | <p>H3 x01</p>  | <p>S3 x200 +2(spare)</p>  | <p>C1 x08</p>  |
| <p>S5 x46</p>  | <p>C23 x04</p>  | <p>S16 x30 +2(spare)</p>  | <p>C7 x12</p>  |
| <p>S11 x12</p>  | <p>SH1 x04</p>  | <p>L3 x82 +2(spare)</p>  | <p>H1B x01</p>  |

PUSH position channel over one end of the sheets, working along the sheets to the other end.

It installs more easily if panels spread on the table

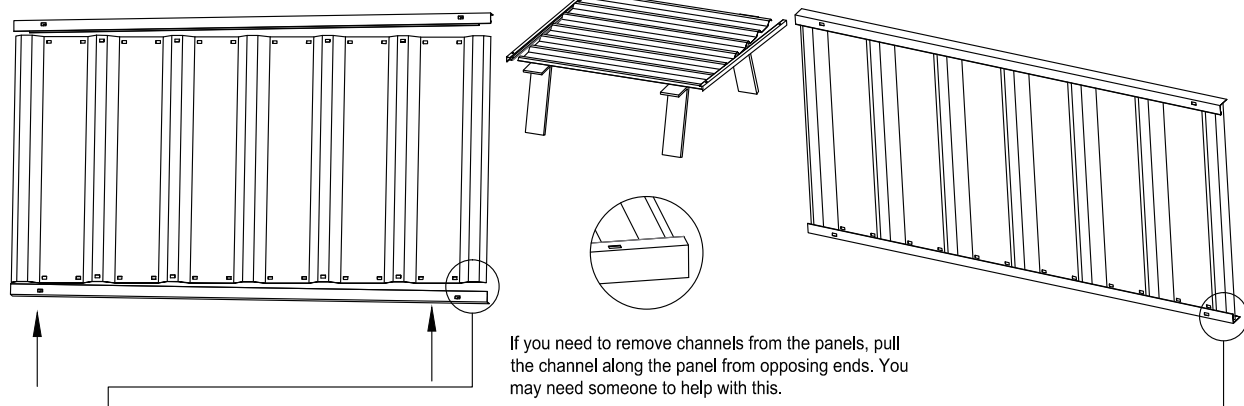

If you need to remove channels from the panels, pull the channel along the panel from opposing ends. You may need someone to help with this.

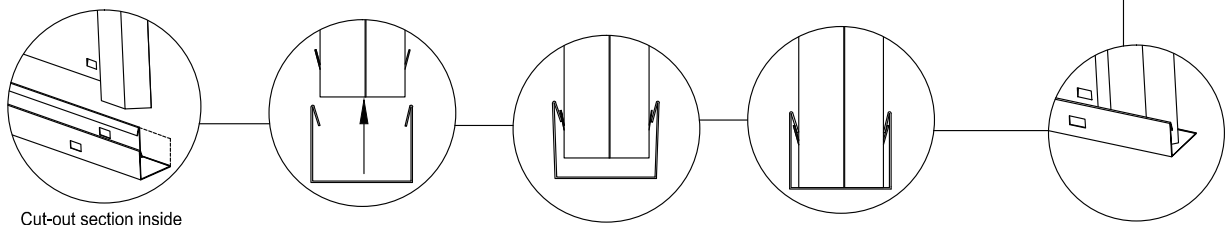



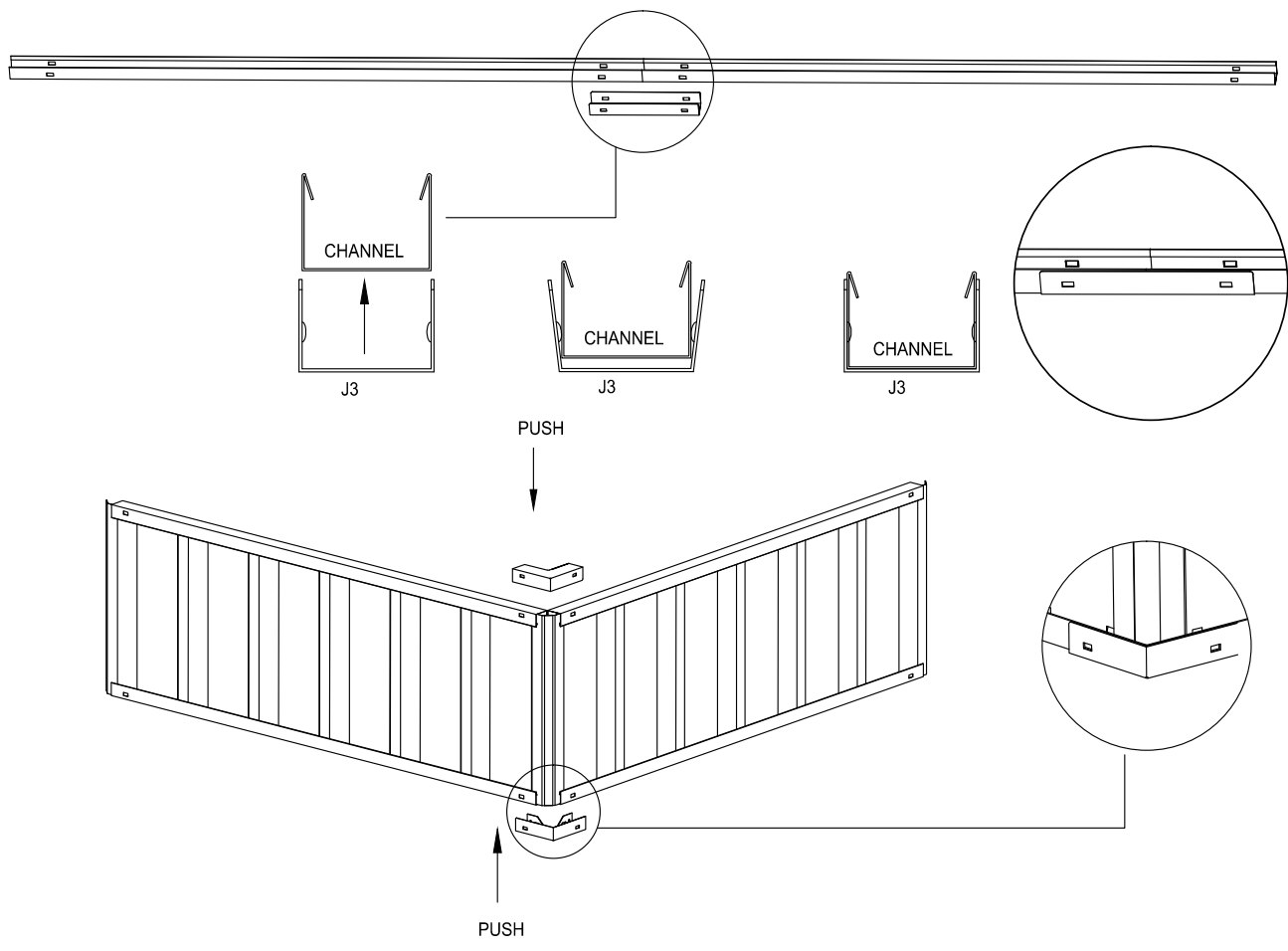

Cut-out section inside

INSTRUCTIONS FOR JOINING SPLICED CHANNELS





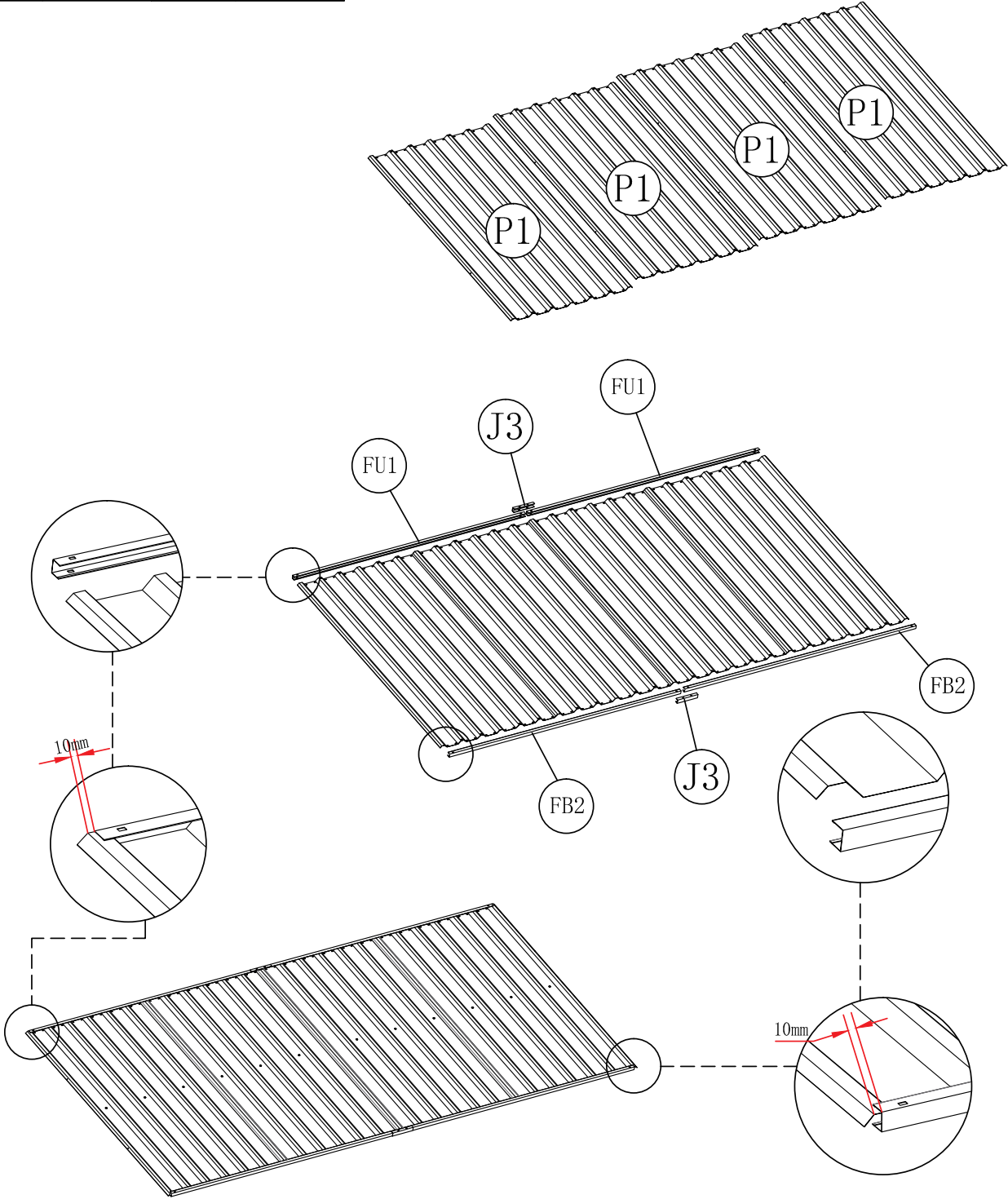

BACK WALL ASSEMBLY





| | | | | | |
|---|-----|---|---|-----|---|
|  | P1 | 4 |  | FU1 | 2 |
|  | FB2 | 2 |  | J3 | 2 |



LEFT WALL ASSEMBLY







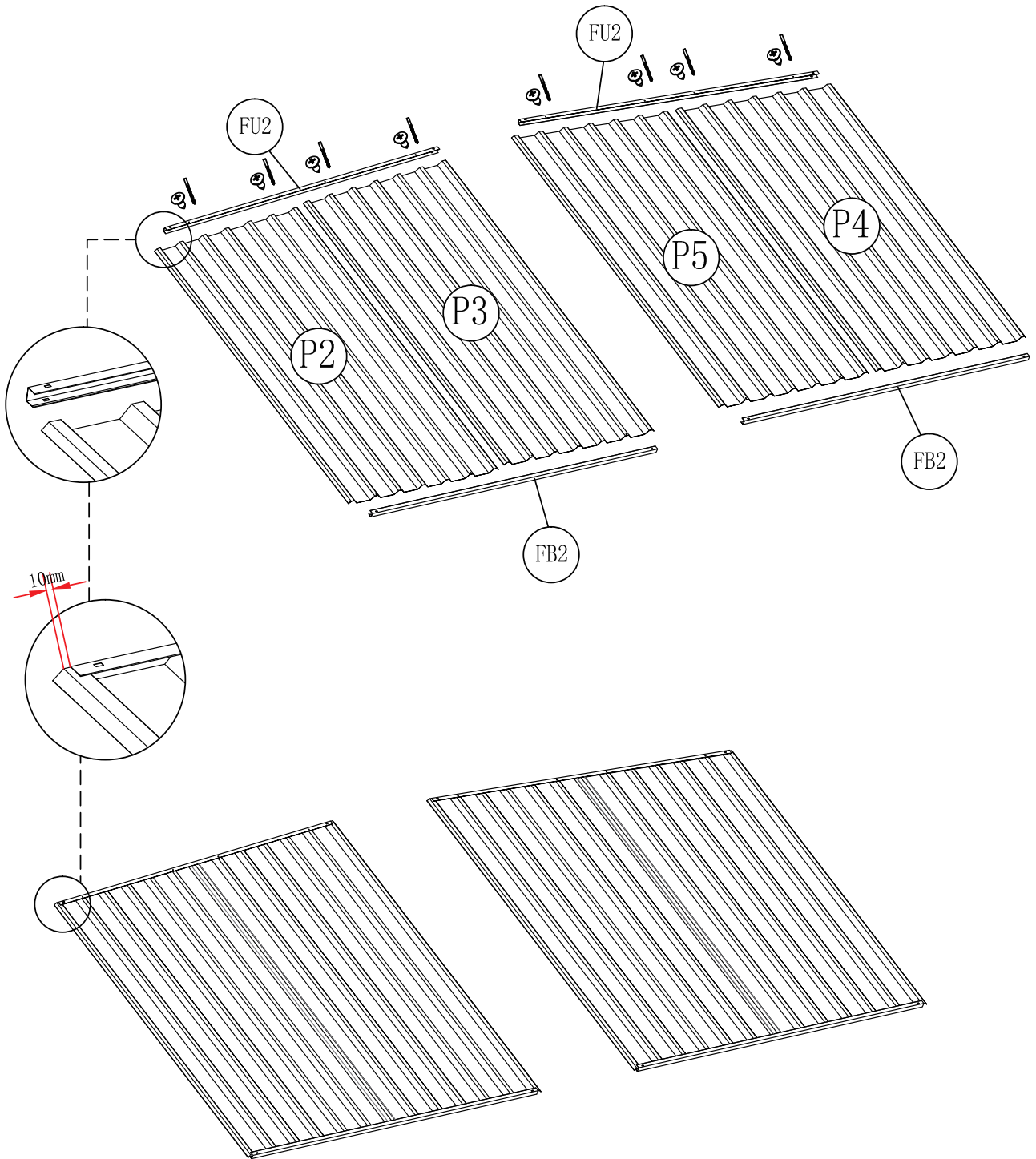

| | | | | | |
|---|----|---|---|-----|---|
|  | P3 | 1 |  | FU2 | 1 |
|  | P2 | 1 |  | FB2 | 1 |
|  | S3 | 4 | | | |

RIGHT WALL ASSEMBLY

| | | | | | |
|--|----|---|---|-----|---|
|  | P4 | 1 |  | FU2 | 1 |
|  | P5 | 1 |  | FB2 | 1 |
|  | S3 | 4 | | | |



FRONT WALL ASSEMBLY

| | | | | | |
|---|------|---|---|-----|----|
|  | P6 | 2 |  | FU1 | 2 |
|  | FB2 | 2 |  | FC2 | 1 |
|  | MS1 | 2 |  | JA2 | 1 |
|  | JAV1 | 2 |  | S3 | 22 |
|  | J3 | 2 | | | |

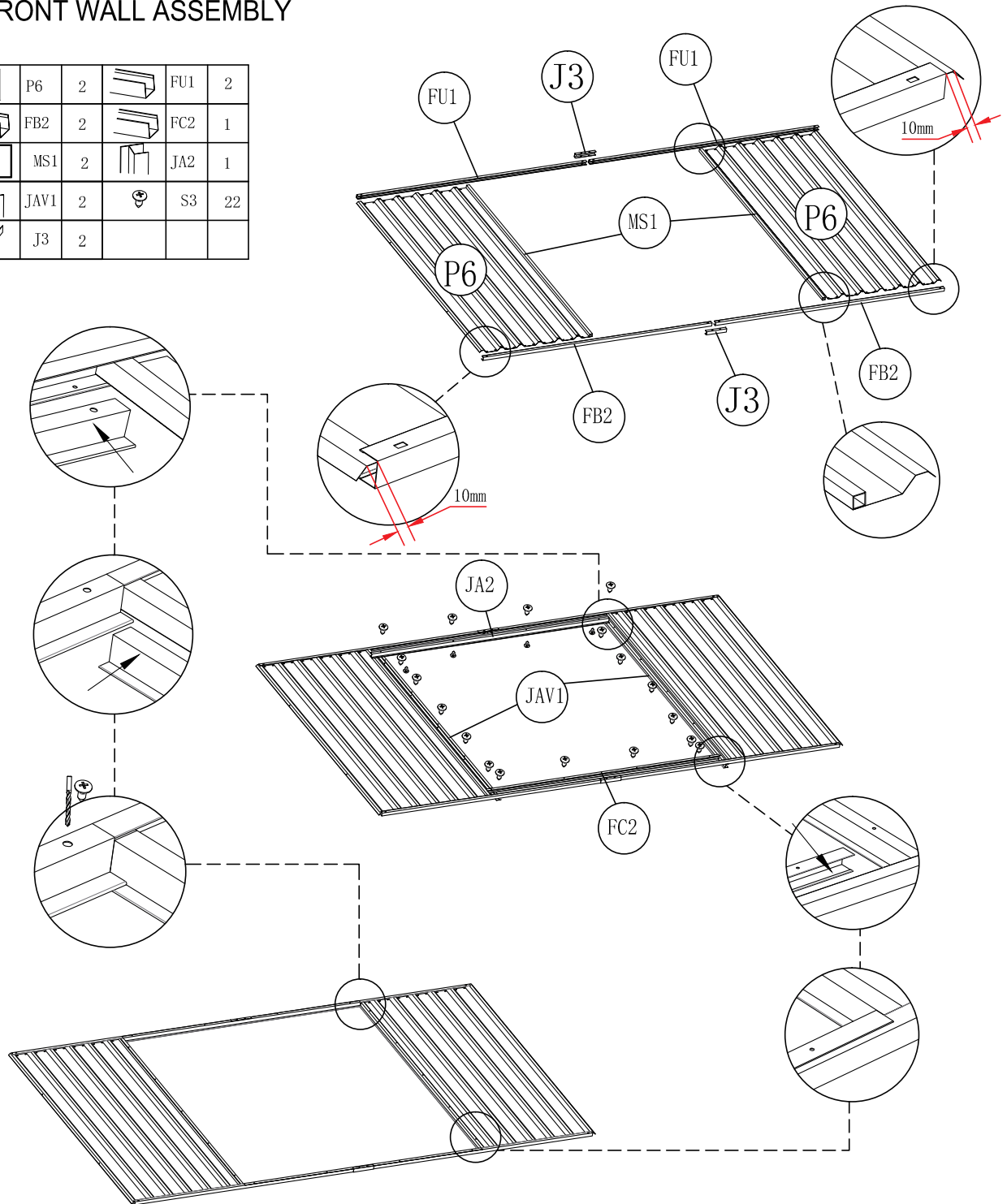

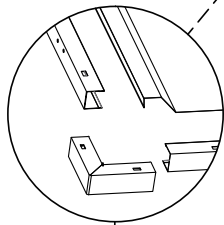
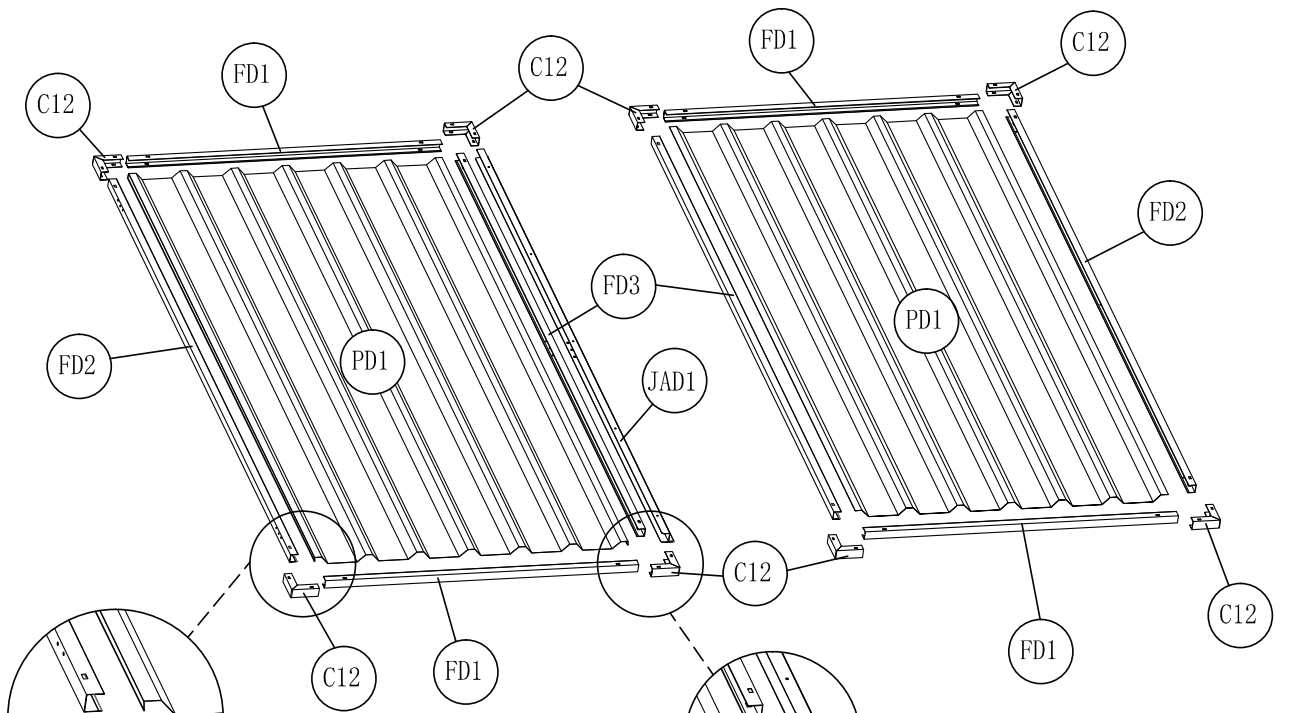



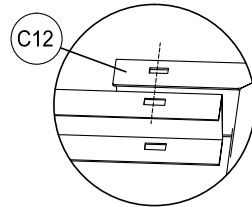
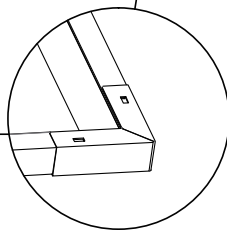
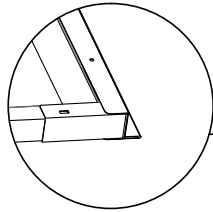
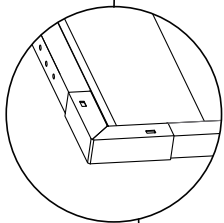

| | | | | | |
|--|------|---|--|-----|---|
| | PD1 | 1 | | | |
| | FD1 | 2 | | FD2 | 1 |
| | FD3 | 1 | | C12 | 4 |
| | JAD1 | 1 | | S3 | 4 |



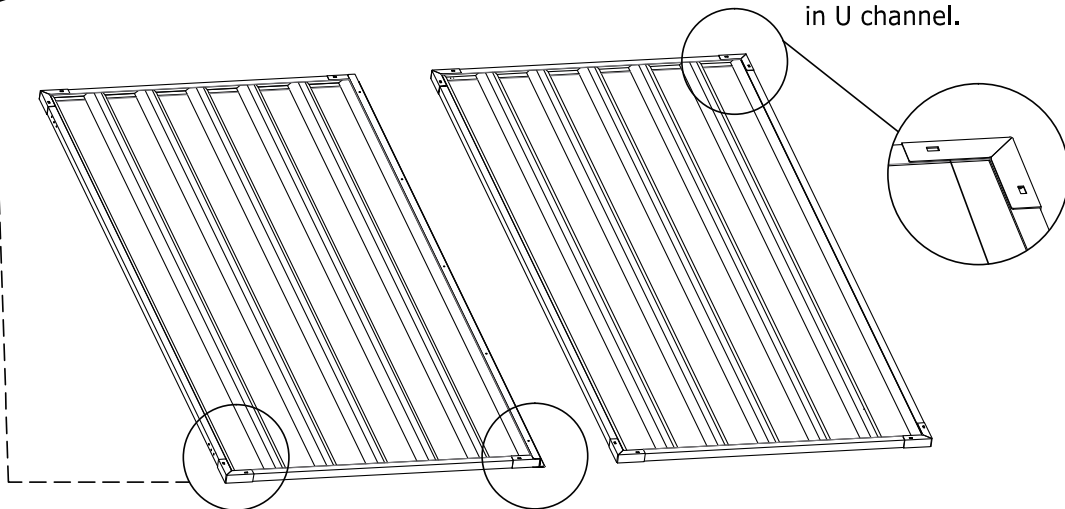

| | | | | | |
|--|-----|---|--|-----|---|
| | PD1 | 1 | | | |
| | FD1 | 2 | | FD2 | 1 |
| | FD3 | 1 | | C12 | 4 |









Warning! Please make sure connect the raised spots on C12 with square holes in U channel.

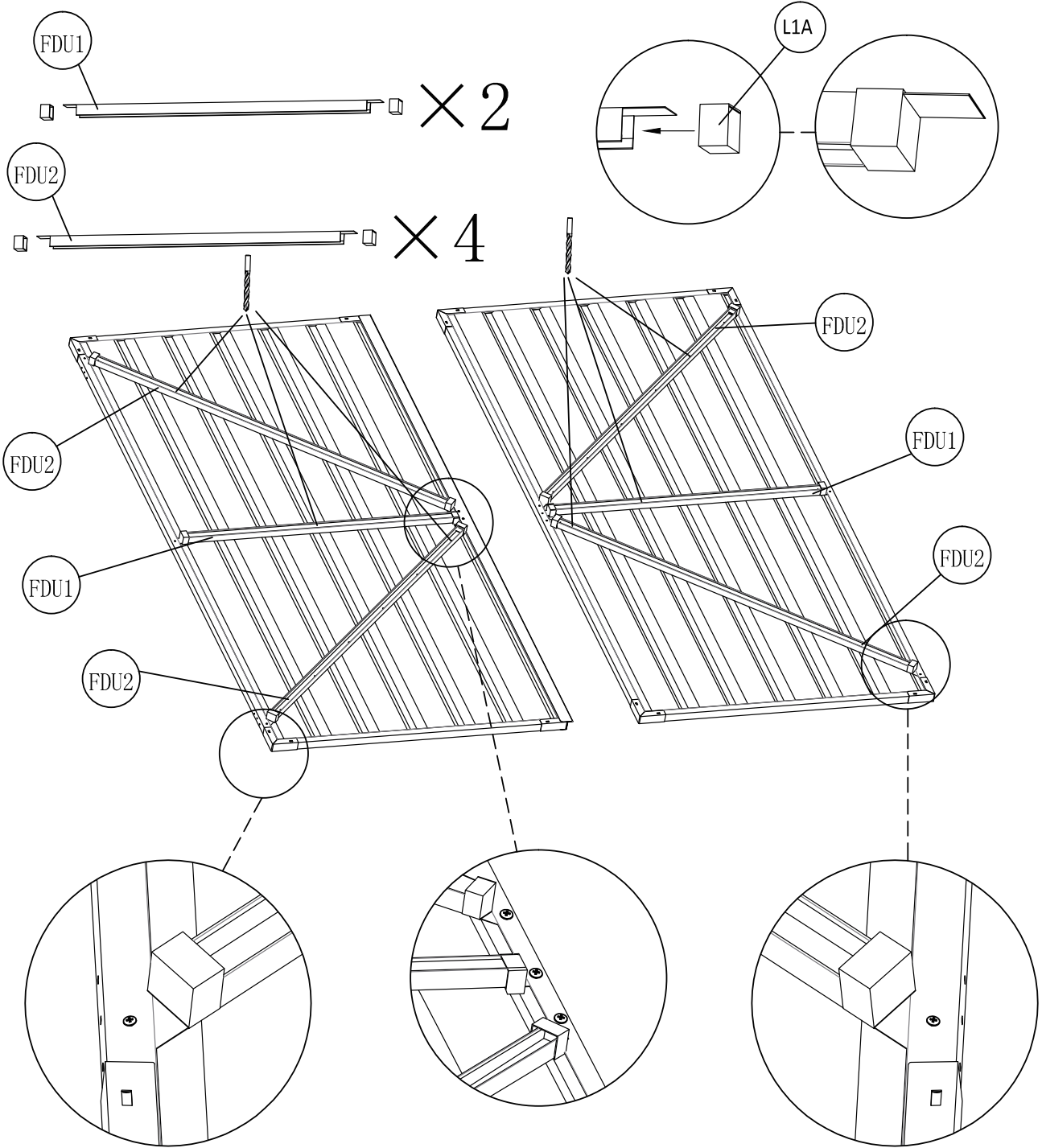





| | | | | | |
|---|------|---|---|------|---|
|  | FDU1 | 1 |  | FDU2 | 2 |
|  | S3 | 6 |  | L1A | 6 |

| | | | | | |
|---|------|---|---|------|---|
|  | FDU1 | 1 |  | FDU2 | 2 |
|  | S3 | 6 |  | L1A | 6 |



| | | | | | |
|---|-----|---|---|----|----|
|  | SH1 | 2 |  | S3 | 18 |
|  | S16 | 6 |  | L3 | 18 |
|  | MSA | 2 | | | |

| | | | | | |
|--|-----|---|---|----|----|
|  | SH1 | 2 |  | S3 | 18 |
|  | S16 | 6 |  | L3 | 18 |
|  | MSA | 2 | | | |

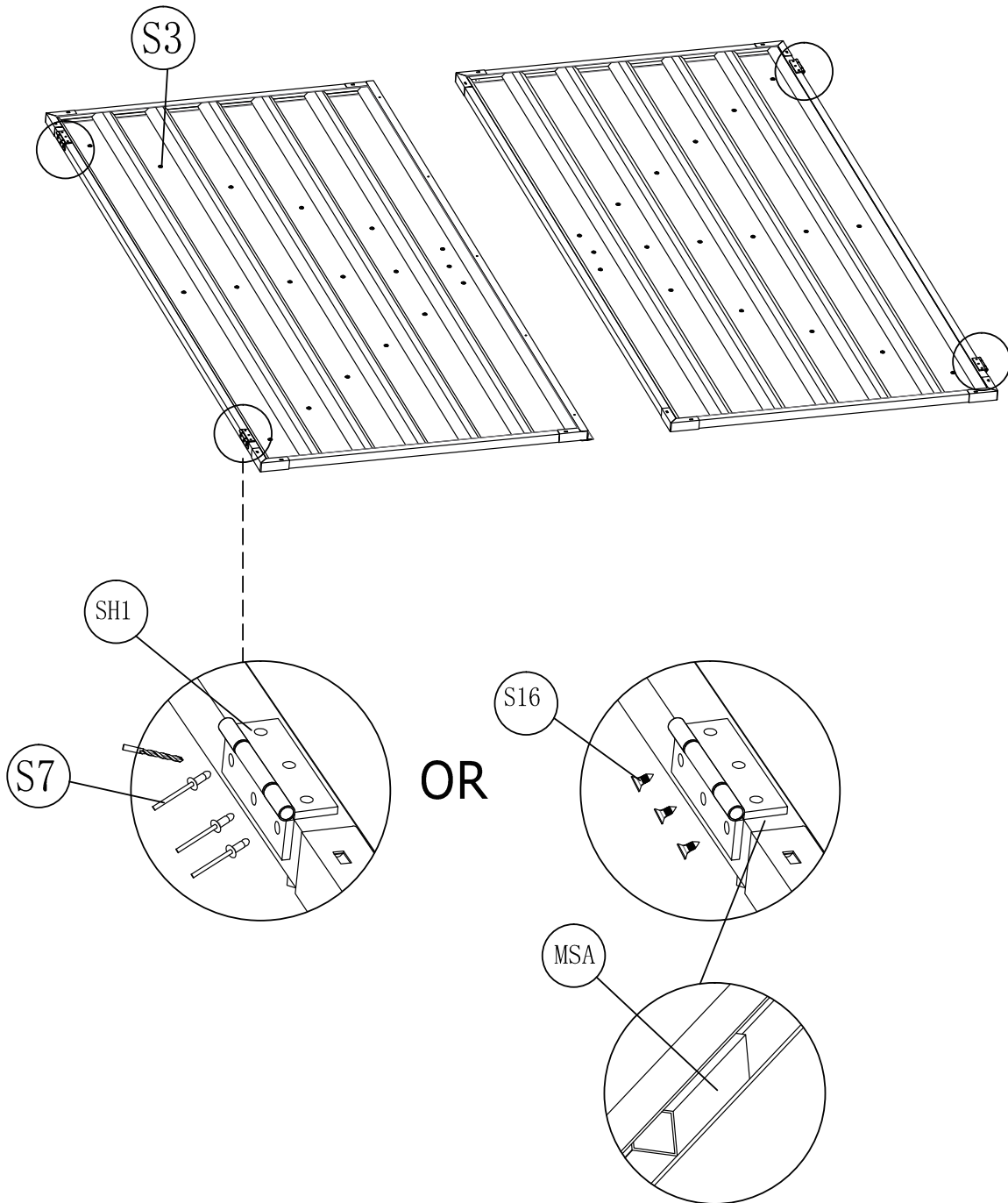





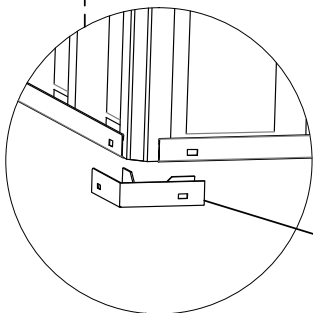
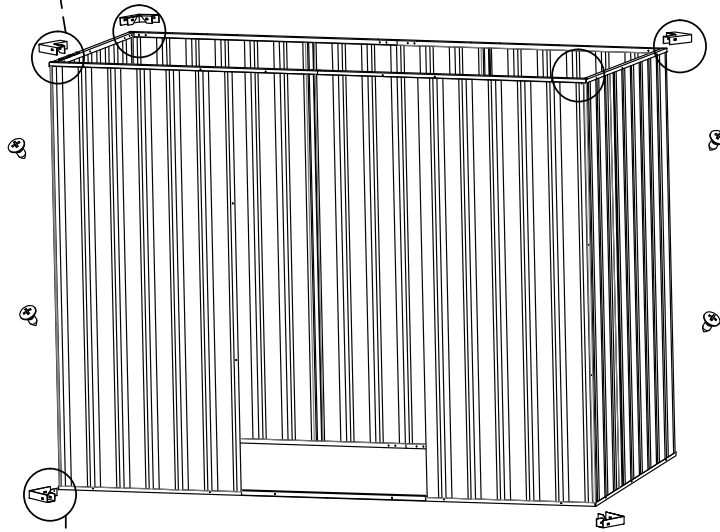
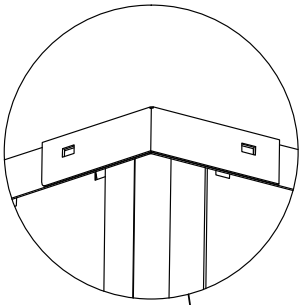



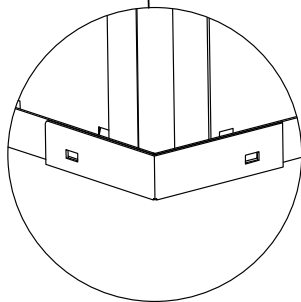





Ensure the correct location of up and down, when you install wallboard



C1





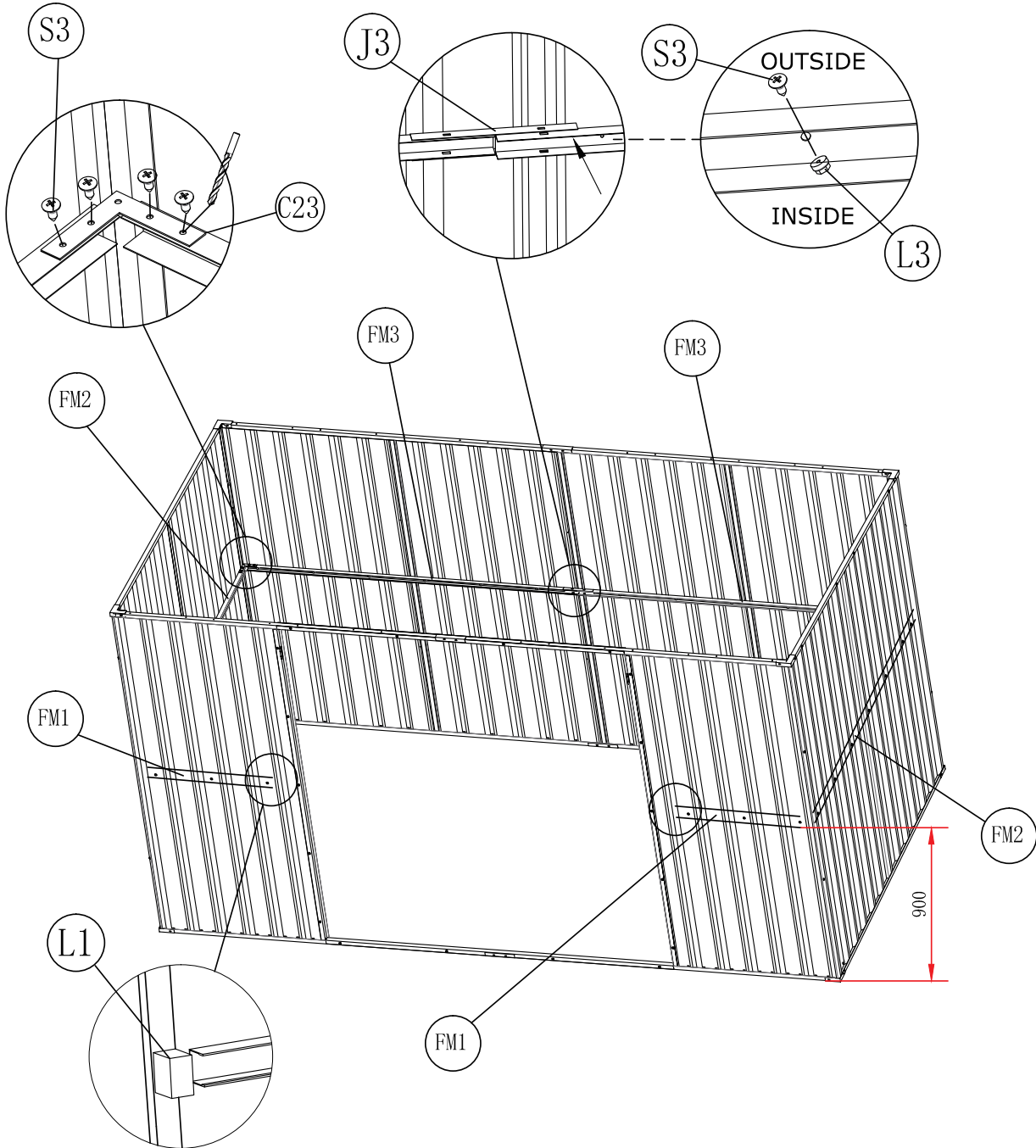

| | | | | | |
|--|----|---|---|----|---|
|  | S3 | 8 |  | L3 | 8 |
|  | C1 | 8 | | | |

| | | | | | |
|---|-----|----|---|-----|---|
|  | FM1 | 2 |  | FM2 | 2 |
|  | FM3 | 2 |  | J3 | 1 |
|  | L3 | 32 |  | L1 | 2 |
|  | S3 | 48 |  | C23 | 4 |





Use the holes of U channel drill new holes on the wall panel and fasten by using S3. Cap all S3 tips with L3.

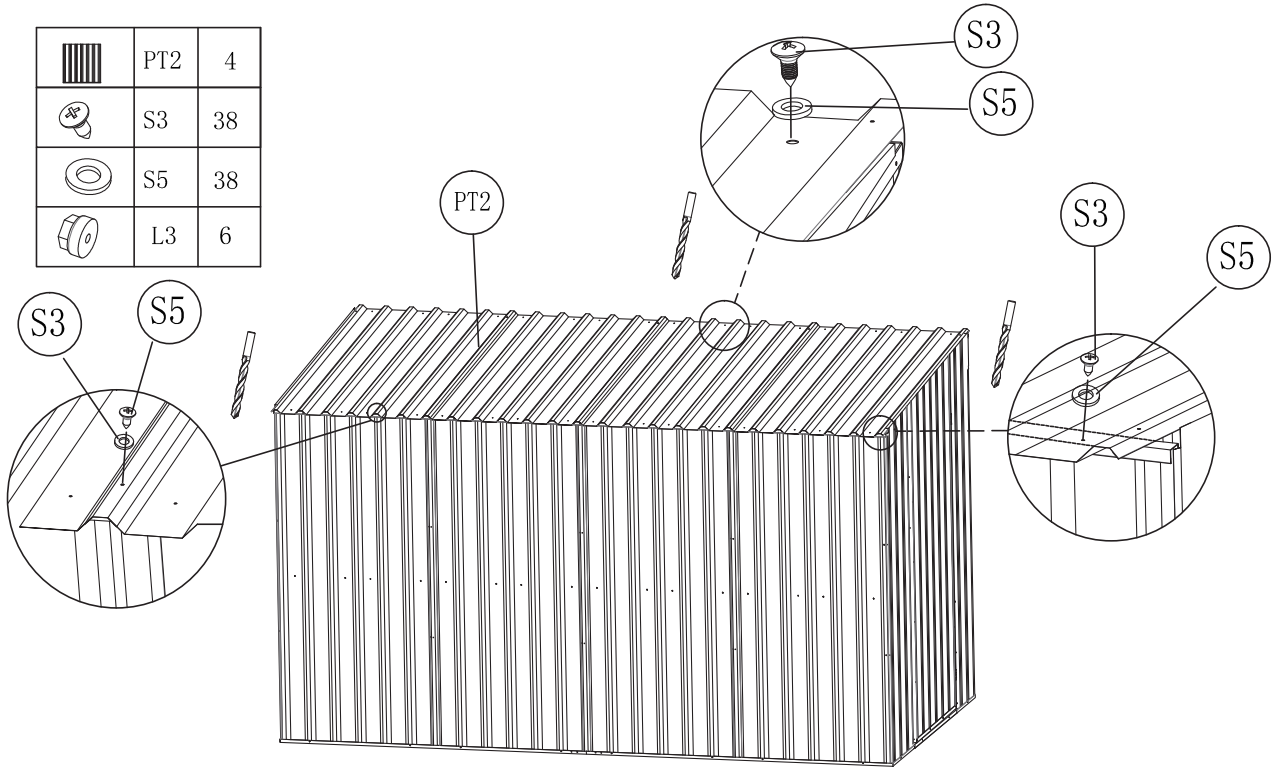

STEP 1.

| | | | | | |
|---|-----|----|--|--|--|
|  | PT2 | 4 | | | |
|  | S3 | 38 | | | |
|  | S5 | 38 | | | |
|  | L3 | 6 | | | |



| | | | | | |
|---|-----|---|---|----|---|
|  | LT1 | 4 |  | S3 | 8 |
|  | LT2 | 2 |  | S5 | 8 |

STEP 3.

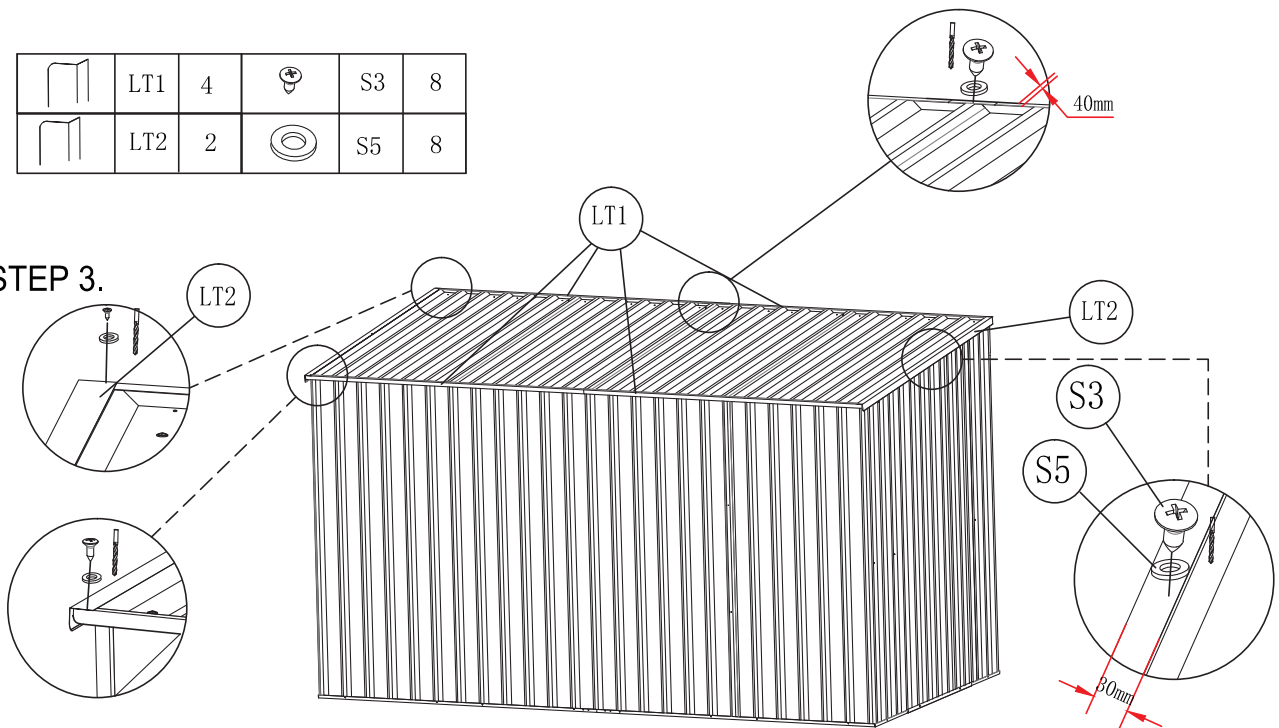

STEP 1.

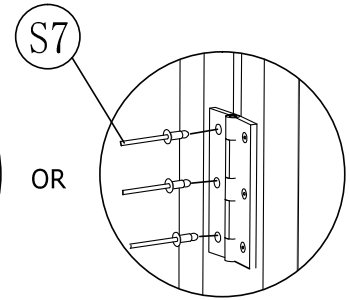
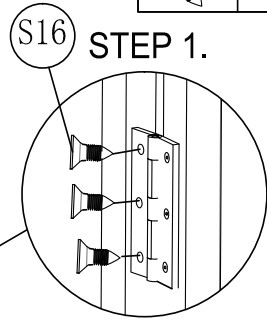
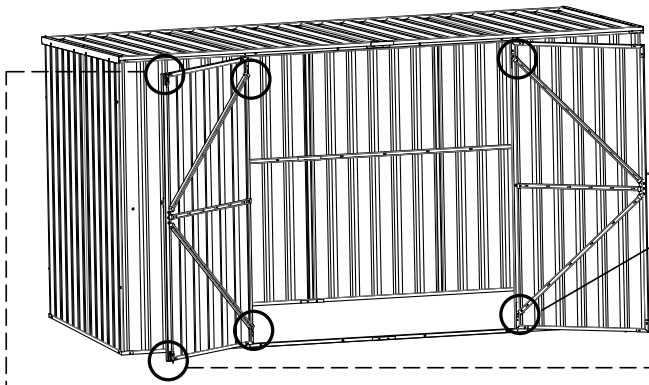

Adjust the position of the door, mark on JAV1 and use the drill to drill through, then use S7 or S16 to connect.

| | | |
|--|-----|----|
|  | S16 | 12 |
|--|-----|----|



STEP 2.

Determine position of lower latch when the door is closed, mark the spot and drill holes, then fix with S3.

| | | | | | |
|---|----|---|---|----|---|
|  | H2 | 1 |  | H3 | 1 |
|  | S3 | 4 | | | |

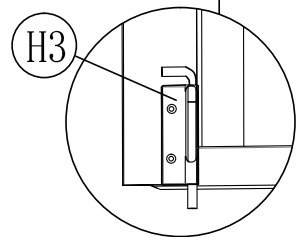
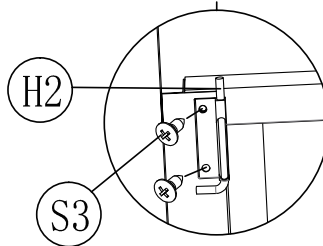



STEP 2.

Adjust the door position until it opens and closes freely, Use the holes on JAV1, drill new holes and fasten using S3.

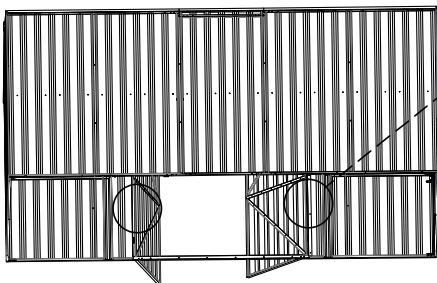
| | | |
|--|----|----|
|  | S3 | 10 |
|--|----|----|



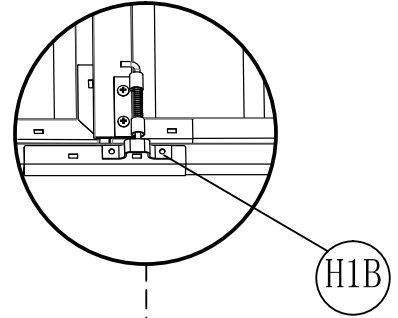
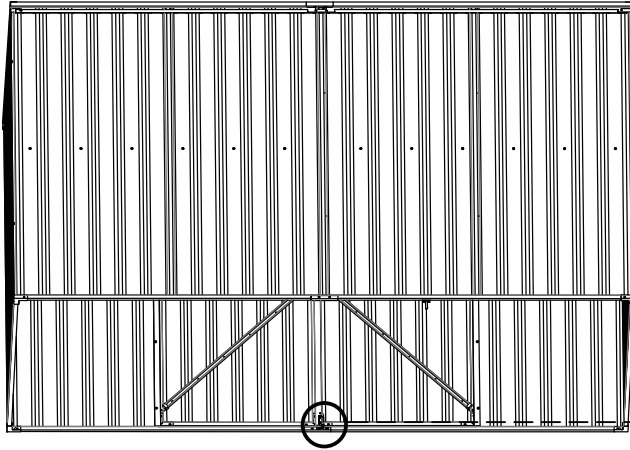

STEP 3.

| | | |
|---|-----|---|
|  | H1B | 1 |
|  | S3 | 2 |



STEP 4.

| | | |
|---|-----|---|
|  | H1 | 1 |
|  | S16 | 6 |

Install the latch in position as shown and fix with S16 or S7.

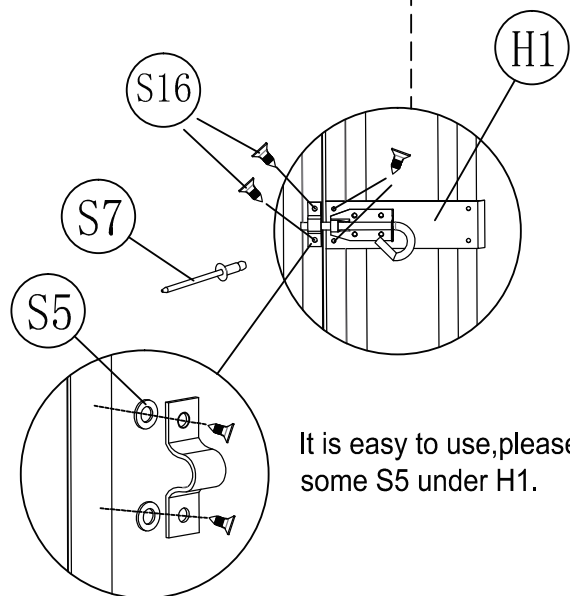
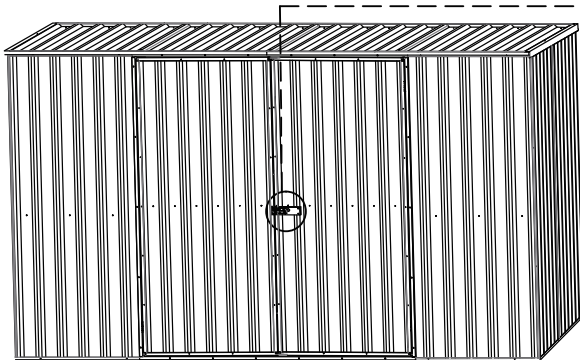

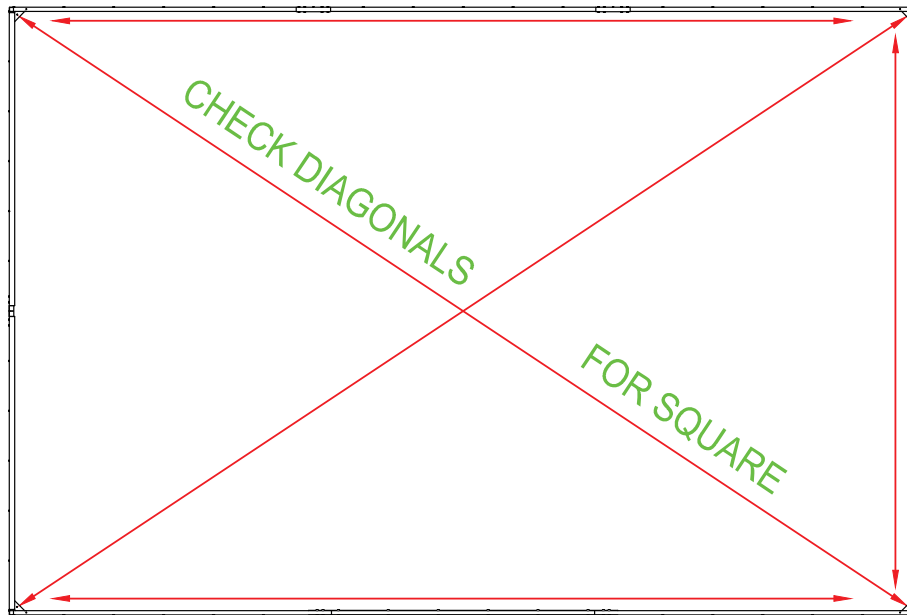

It is easy to use, please add some S5 under H1.

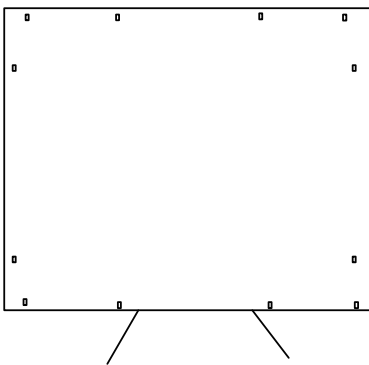

The shed is now free standing. It is critical at this stage, to ensure the shed is leveled. Also by measuring the diagonal distance, make sure the four side walls form a perfect square.

ANCHORING OF SHED



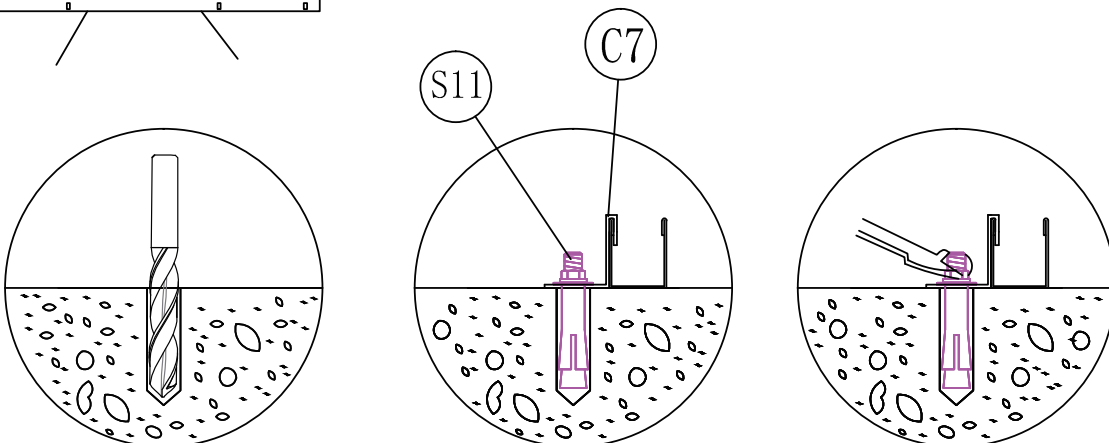

| | | |
|---|-----|----|
|  | C7 | 12 |
|  | S11 | 12 |

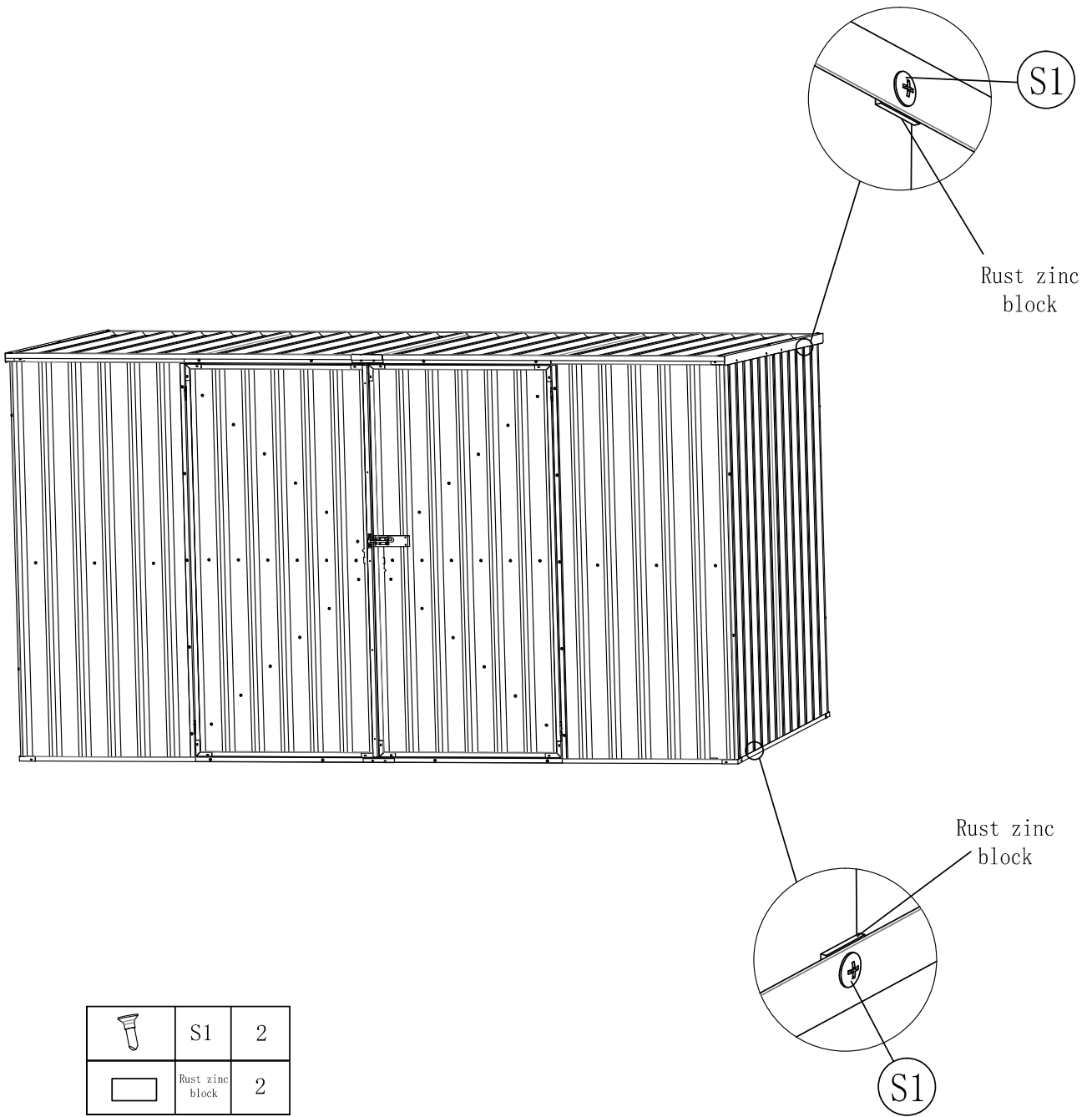

Fastening the anchor kit onto a concrete pad

1. Mark the spot of the anchor clamps on the ground
2. Use 12mm concrete drill bit and drill holes 60mm deep
3. Tap concrete fixing bolts into the hole, place anchor clamps, add washer and nut and fasten.



| | | |
|---|-----------------|---|
|  | S1 | 2 |
|  | Rust zinc block | 2 |

Tips: Please make Pre punching in Rust zinc block, which is easy for installing。