

# CCD-WD INSTALL GUIDE

## DIMENSIONAL RENDERINGS

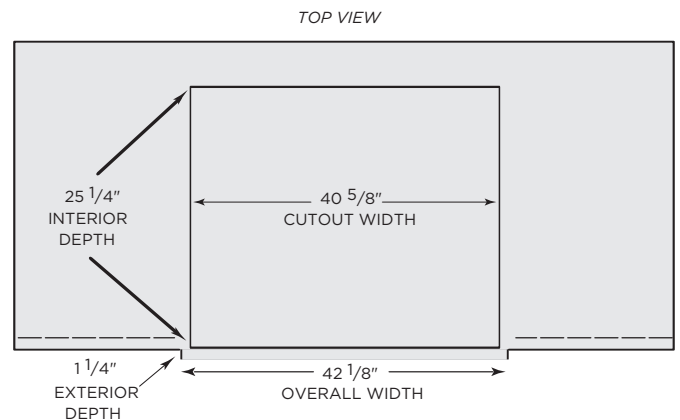
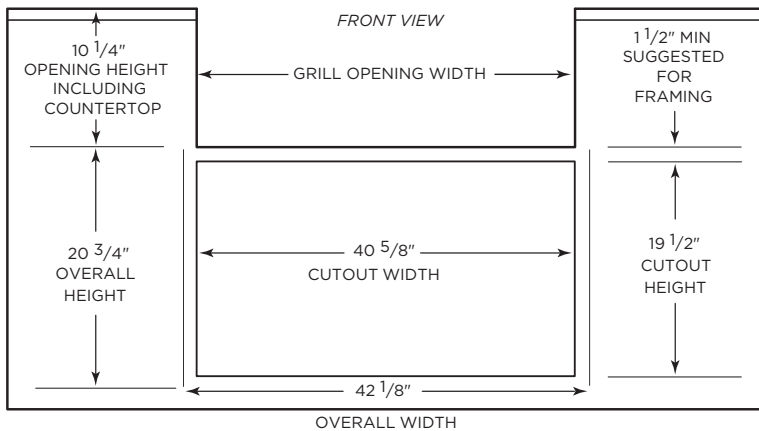
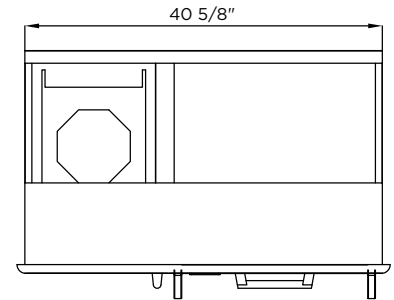
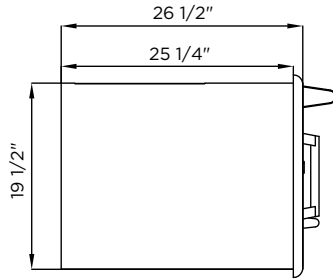
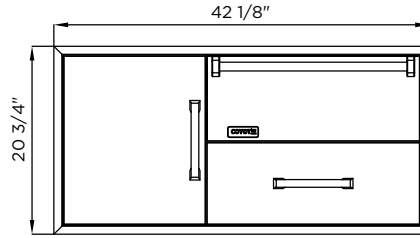
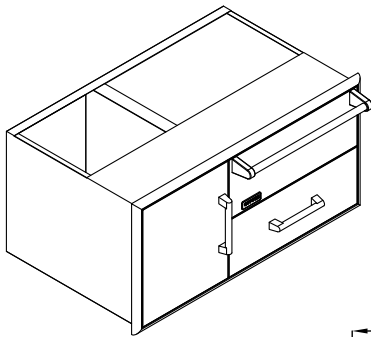

Overall Product Dimensions			
Model No.	Height	Width	Depth
CCD-WD	20 3/4"	42 1/8"	26 1/2"

Cutout Dimensions for Island			
Model No.	Height	Width	Depth
CCD-WD	19 1/2"	40 5/8"	25 1/4"

### Install Notes:

- ✓ 2 anchor points are located on each side of the doors interior frame (top, bottom, left and right)
- ✓ Due to wide variance of possible building materials, anchors are not included
- ✓ When inserting your anchors be sure to use a framing square to ensure the door is not pulled out of square
- ✓ Additional framing and/or support underneath the rear (hanging portion) of the cabinet is recommended
- ✓ These specs are accurate but we always suggest having the product physically on site to ensure full understanding of how this product will coordinate with your build

### Electrical Requirements:

- ✓ This refrigerator must be installed in accordance with National Electric Codes, as well as state, municipal and local codes
- ✓ The correct voltage, frequency and amperage must be supplied to the refrigerator from a grounded circuit which is protected by a properly sized circuit breaker or time delay fuse.
- ✓ The proper voltage, frequency and amperage ratings are listed on the product rating plate.
- ✓ The warming drawer must be properly grounded at all times when electrical power is applied.
- ✓ Never allow any debris to build up underneath, or in front of the unit, blocking ventilation.

**Important Note to Installer:** This file is not intended to replace your Owners' Manual which contains specific safety requirements and consumer guidelines. Please refer to your Owners' Manual prior to installing or operating your built-in warming drawer.