

This **ShelfTalker™** catalog contains **43** of the more generally utilized part shapes. Simply choose a part shape, send us the artwork and we'll manufacture a ShelfTalker™ that meets your requirements!

kostklip®, however, can also produce a full custom solution that meets any shape or colour/graphic requirement. Please contact us for more information for your specific requirements.

See also page 14 for in-stock **preprinted Signature Series ShelfTalkers™**.



shown: Signature Series™ - Bib Tag with Right Angle Flag

To Order

1.800.661.5547

sales@kostklip.com

www.kostklip.com

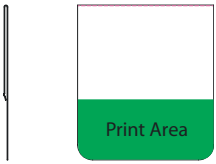
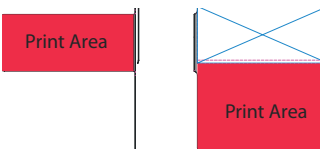
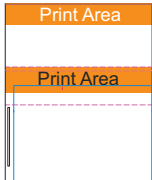
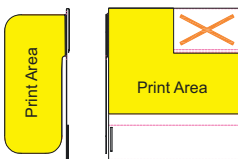
	Item No.	Die No.	Overall W"xH"	Top fold	Bottom fold	Ticket W"xH"	Page
Bib Tag							
	1	KK0051	2.0"x 3.125"	1.25"	N/A	2.0"x 1.25"	4
	2	KK0119	2.5"x 3.0"	1.25"	N/A	2.5"x 1.25"	4
	3	KK0043	2.75"x 3.00"	1.25"	N/A	2.75"x 1.25"	4
	4	KK0126	3.125"x 2.5"	1.25"	N/A	3.125"x 1.25"	4
	5	KK0142	3.625"x 3.0"	1.25"	N/A	3.625"x 1.25"	4
	6	KK0028	3.75"x 2.625"	1.25"	N/A	3.75"x 1.25"	5
Bib Tag with Right Angle Flag							
	7	KK0108	2.0"x 2.25"	1.25"	N/A	2.0"x 1.25"	6
	8	KK0120	2.5"x 3.0"	1.25"	N/A	2.5"x 1.25"	6
	9	KK0088	2.875"x 3.25"	1.25"	N/A	2.875"x 1.25"	6
	10	KK0177	3.5"x 3.0"	1.25"	N/A	3.5"x 1.5"	6
	11	KK0143	3.625"x 3.0"	1.25"	N/A	3.625"x 1.25"	6
	12	KK0117	5.375"x 2.438"	1.25"	N/A	2.5"x 2.2"(Pouch)	7
Right Angle Flag							
	13	KK0069	2.0"x 2.25"	1.25"	N/A	2.0"x 1.25"	7
	14	KK0160	2.2"x 1.375"	1.25"	N/A	2.2"x 1.25"	7
	15	KK0100	2.5"x 1.25"	1.25"	N/A	2.5"x 1.25"	7
Ticket Holder							
	16	KK0114	2.0"x 3.531"	1.25"	1"	1.75"x 2.25"	8
	17	KK0144	2.20"x 3.53"	1.25"	0.875"	2.0"x 2.25"	8
	18	KK1001	2.25"x 2.625"	1.25"	1"	2.0"x 1.25"	8
	19	KK0058	2.625"x 2.625"	1.25"	1"	2.375"x 1.25"	8
	20	KK0097	2.75"x 3.625"	1.25"	1"	2.5"x 1.25"	8
	21	KK0127	3.325"x 2.5"	1.25"	1"	3.125"x 1.25"	9
	22	KK1004	3.75"x 3.625"	1.25"	1"	3.5"x 1.25"	9
	23	KK1005	3.75"x 2.625"	1.25"	1"	3.5"x 1.25"	9
	24	KK0125	5.5"x 8.625"	1.25"	7.75"	5.5"x 8.5"	9
	25	KK0031	6.0"x 4.375"	1.25"	1.5"	5.5"x 4.25"	9
	26	KK0155	6.375"x 4.0"	1.25"	1.5"	6.0"x 3.875"	10
	27	KK1007	6.4"x 3.875"	1.25"	1.5"	6.0"x 3.75"	10
	28	KK0161	8.5"x 2.875"	1.25"	2.0"	8.5"x 2.75"	10
	29	KK0163	9.0"x 3.125"	N/A	3"	8.5"x 2.75"	10
	30	KK0133	9.25"x 3.125"	N/A	3"	8.5"x 2.75"	10
	31	KK0113	11.2"x 8.58"	1.25"	4"	11"x 8.5"	11
	32	KK1010	11.9"x 7.375"	1.25"	3"	11.5"x 7.25"	11
33	KK0156	12.0"x 7.5"	1.25"	3"	11.625"x 7.25"	11	
Ticket Holder with Right Angle Flag							
	34	KK0078	2.625"x 2.625"	1.25"	1"	2.375"x 1.25"	12
	35	KK0052	3.75"x 3.625"	1.25"	1.625"	3.75"x 3.5"	12
	36	KK0089	4.45"x 2.625"	1.25"	0.875"	4.25"x 2.5"	12
	37	KK0164	5.2"x 2.25"	1.25"	1"	5.0"x 2.25"	12
	38	KK0096	2.75"x 3.625"	1.25"	1"	2.5"x 1.25"	12
	39	KK0040	3.75"x 4.375"	1.25"	1"	3.65"x 1.25"	13
	40	KK0050	2.2"x 3.875"	1.25"	1.5"	2.0"x 2.0"	13
	41	KK0129	3.325"x 2.563"	1.25"	1"	3.125"x 1.25"	13
	42	KK0103	2.2"x 3.437"	1.25"	1"	2.0"x 1.25"	13
	43	KK0110	3.7"x 3.55"	1.25"	1.072"	3.5"x 2.2"	13

Ordering Steps

1. Select a part shape that meets your requirements.
2. Submit your artwork and specify the part shape, quantities, PMS colors required, and request a quotation from kostklip.
3. When the quotation is approved, place your order with a 50% deposit and a written approved Purchase Order.
4. Kostklip will email an artwork position proof for physical signoff prior to printing.
5. Parts are printed, manufactured and delivered.

Minimum Orders

Based on an average part size, the Minimum Custom Order is 5,000 pieces. However, for larger size parts, such as 11" x 8.5", a less than 5,000 piece order may be accepted. Contact us for your specific requirements.

Materials and Thicknesses

ShelfTalkers[™] are manufactured using a clear 0.012" thick recyclable PVC. Other thicknesses may be available.

Screen Printing

Solid colors: Screen printing is the standard printing process, and up to 6 different spot Pantone colors are available to use. White must be one of the colors used unless transparency is required.

4 color process - CMYK: Process color printing may be used if there are photographic images and complex color blends. A customer supplied printout is required for color matching. Digital prepress proofs are available at extra cost and are highly recommended.

Artwork

Acceptable Formats: AI, EPS vector files will generate the best results with screen printing using spot colors; however JPEG, TIFF, BMP, PDF are accepted for photographic or blend images if CMYK is required.

Artwork Charge: Additional work effort in the preparation of print ready files may be required, at additional cost.

Artwork requirement: 300 dpi at 100% scale is required for non-vector images. All fonts used should be 'outlined'. Font sizes should not be smaller than 7pt.

Color: PMS color numbers are required for CMYK color equivalents to achieve best results in screen printing.

Artwork Proof: Kostklip[®] will send an (unsynchronized color) artwork position proof after receiving all necessary files. The artwork proof must then be physically signed-off and faxed to kostklip before the order is processed.

Ticket, label, and sign size

The stock part shape selected must fit your ticket size, however custom sizes are available. Please contact us with your questions or requirements.

Shelf Channel Installation

Our stock ShelfTalkers[™] are designed to fit into kostklip ClearVision[®] ticket moldings, however, if a ClearVision[®] brand ticket molding is not used, please submit a sample of that ticket molding is required to ensure good fit. If the ShelfTalker is to be placed into an open metal shelf channel, the name of shelf manufacturer is required.

Prototypes

If a custom-made sample of a specific request is required, a charge would apply to cover the costs of the hand-made mock-up.

BIB TAG | ShelfTalkers™

1

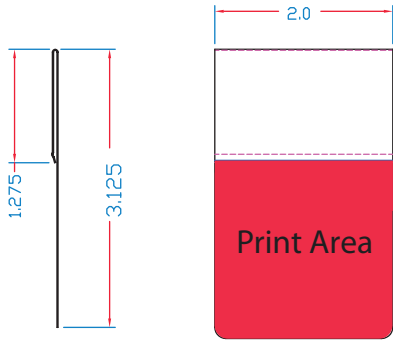

Die No.	Overall size	Top fold	Bottom fold	Ticket size
	W"xH"			W"xH"
KK0051	2.0"x 3.125"	1.25"	N/A	2.0"x 1.25"

2

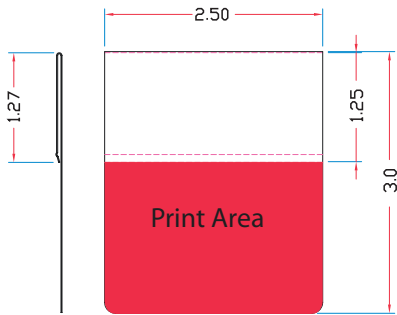

Die No.	Overall size	Top fold	Bottom fold	Ticket size
	W"xH"			W"xH"
KK0119	2.5"x 3.0"	1.25"	N/A	2.5"x 1.25"

3

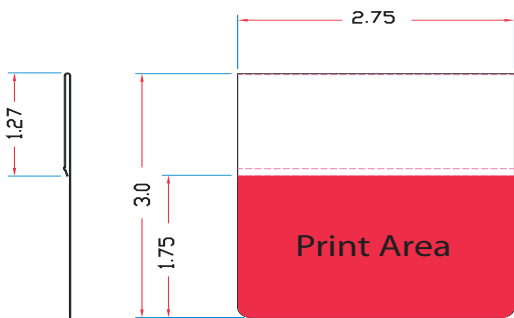

Die No.	Overall size	Top fold	Bottom fold	Ticket size
	W"xH"			W"xH"
KK0043	2.75"x 3.0"	1.25"	N/A	2.75"x 1.25"

4

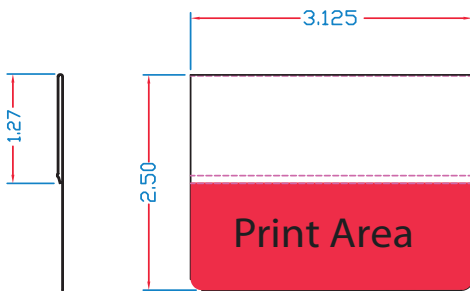

Die No.	Overall size	Top fold	Bottom fold	Ticket size
	W"xH"			W"xH"
KK0126	3.125"x 2.5"	1.25"	N/A	3.125"x 1.25"

5



Die No.	Overall size	Top fold	Bottom fold	Ticket size
	W"xH"			W"xH"
KK0142	3.625"x 3.0"	1.25"	N/A	3.625"x 1.25"

6

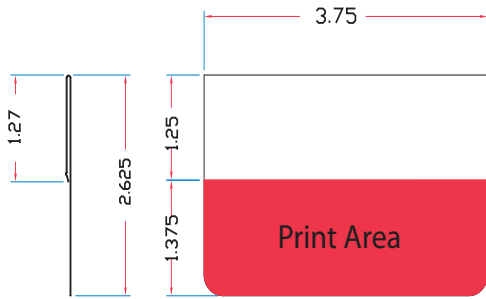

Die No.	Overall size	Top fold	Bottom fold	Ticket size
	W"xH"			W"xH"
KK0028	3.75"x 2.625"	1.25"	N/A	3.75"x1.25"

7

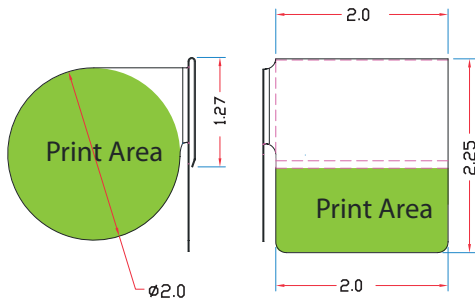

Die No.	Overall size		Ticket size	
	W"xH"	Top fold	Bottom fold	W"xH"
KK0108	2.0"x 2.25"	1.25"	N/A	2.0"x1.25"

8

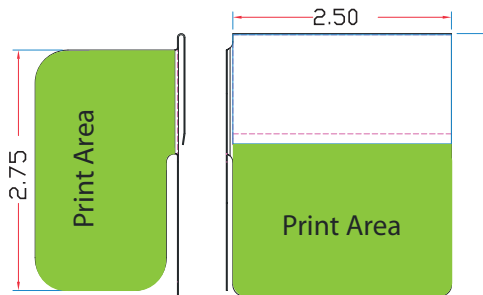

Die No.	Overall size		Ticket size	
	W"xH"	Top fold	Bottom fold	W"xH"
KK0120	2.5"x 3.0"	1.25"	N/A	2.5"x1.25"

9

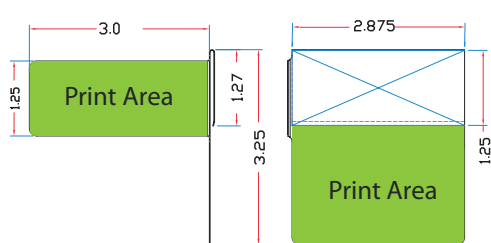

Die No.	Overall size		Ticket size	
	W"xH"	Top fold	Bottom fold	W"xH"
KK0088	2.875"x 3.25"	1.25"	N/A	2.875"x1.25"

10

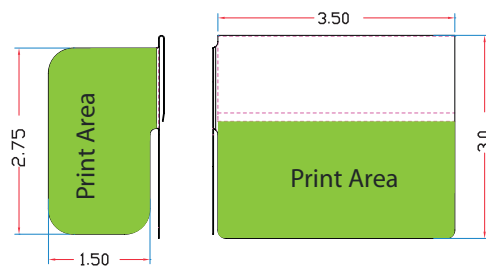

Die No.	Overall size		Ticket size	
	W"xH"	Top fold	Bottom fold	W"xH"
KK0177	3.5"x 3.0"	1.25"	N/A	3.5"x1.5"

11

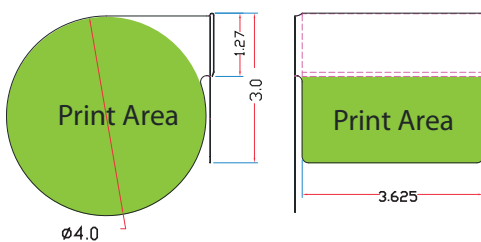

Die No.	Overall size		Ticket size	
	W"xH"	Top fold	Bottom fold	W"xH"
KK0143	3.625"x3.0"	1.25"	N/A	3.625"x1.25"

12

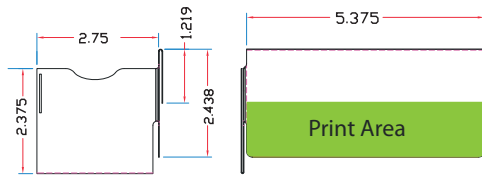

Die No.	Overall size		Ticket size	
	W"xH"	Top fold	Bottom fold	W"xH"
KK0117	5.375" x 2.438"	1.25"	N/A	2.5" x 2.2" (Pouch)

Note: Ticket pocket welded on left of the right flag pouch

RIGHT ANGLE FLAG | ShelfTalkers™

13

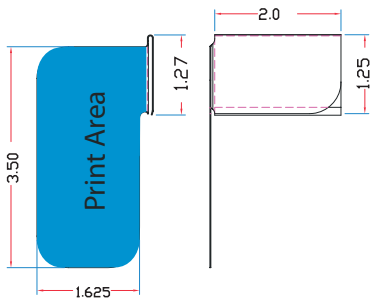

Die No.	Overall size		Ticket size	
	W"xH"	Top fold	Bottom fold	W"xH"
KK0069	2.0" x 2.25"	1.25"	N/A	2.0" x 1.25"

14

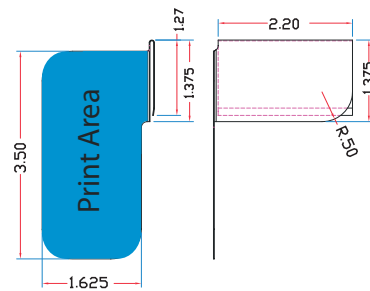

Die No.	Overall size		Ticket size	
	W"xH"	Top fold	Bottom fold	W"xH"
KK0160	2.2" x 1.375"	1.25"	N/A	2.2" x 1.25"

15

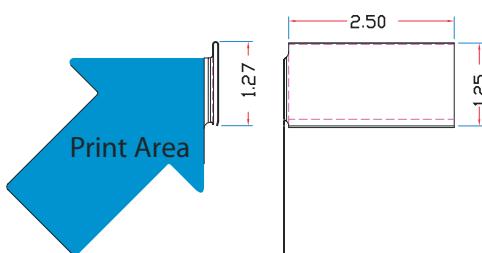

Die No.	Overall size		Ticket size	
	W"xH"	Top fold	Bottom fold	W"xH"
KK0100	2.5" x 1.25"	1.25"	N/A	2.5" x 1.25"

16

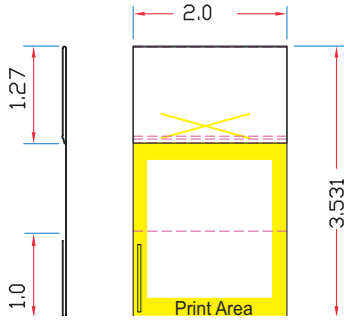

Die No.	Overall size		Ticket size	
	W"xH"	Top fold	Bottom fold	W"xH"
KK0114	2.0"x 3.531"	1.25"	1"	1.75"x2.25"

Note: Ticket pocket welded on left side

17

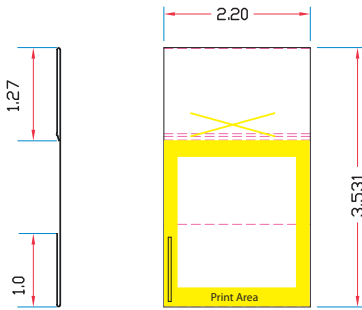

Die No.	Overall size		Ticket size	
	W"xH"	Top fold	Bottom fold	W"xH"
KK0144	2.20"x 3.53"	1.25"	0.875"	2.0"x2.25"

Note: Ticket pocket welded on left side

18

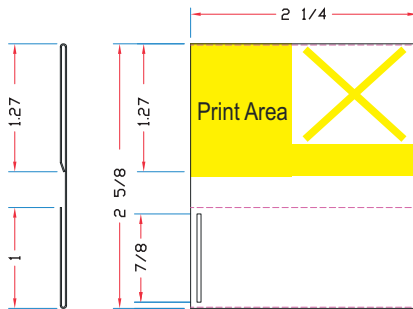

Die No.	Overall size		Ticket size	
	W"xH"	Top fold	Bottom fold	W"xH"
KK1001-02	2.25"x 2.625"	1.25"	1"	2.0"x1.25"

Note: Ticket pocket welded on left side

19

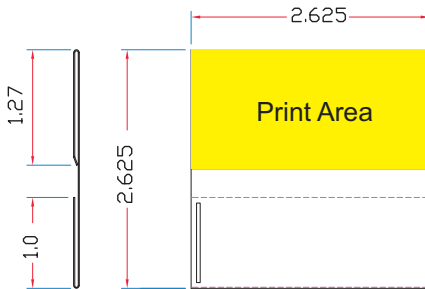

Die No.	Overall size		Ticket size	
	W"xH"	Top fold	Bottom fold	W"xH"
KK0058	2.625"x 2.625"	1.25"	1"	2.375"x1.25"

Note: Ticket pocket welded on left side

20

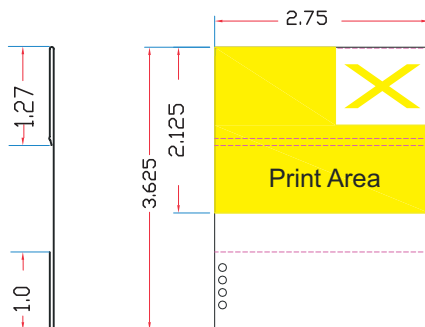

Die No.	Overall size		Ticket size	
	W"xH"	Top fold	Bottom fold	W"xH"
KK0097	2.75"x 3.625"	1.25"	1"	2.5"x1.25"

Note: Ticket pocket welded on left side

21

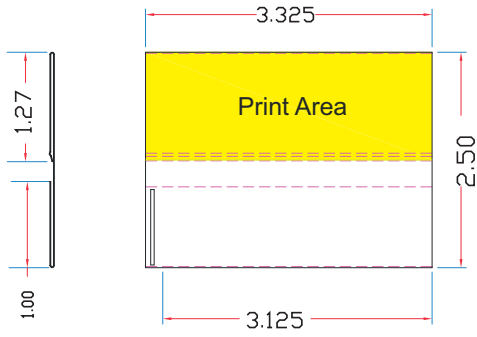

Die No.	Overall size		Ticket size	
	W"xH"	Top fold	Bottom fold	W"xH"
KK0127	3.325"x 2.5"	1.25"	1"	3.125"x1.25"

Note: Ticket pocket welded on left side

22

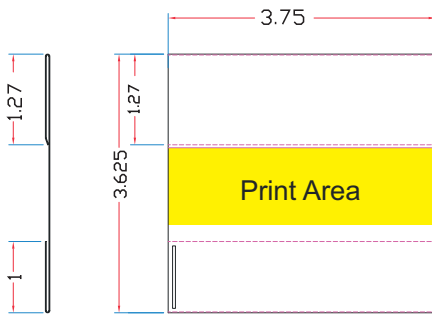

Die No.	Overall size		Ticket size	
	W"xH"	Top fold	Bottom fold	W"xH"
KK1004	3.75"x 3.625"	1.25"	1"	3.5"x1.25"

Note: Ticket pocket welded on left side

23

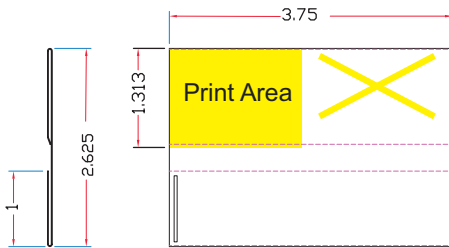

Die No.	Overall size		Ticket size	
	W"xH"	Top fold	Bottom fold	W"xH"
KK1005	3.75"x 2.625"	1.25"	1"	3.5"x1.25"

Note: Ticket pocket welded on left side

24

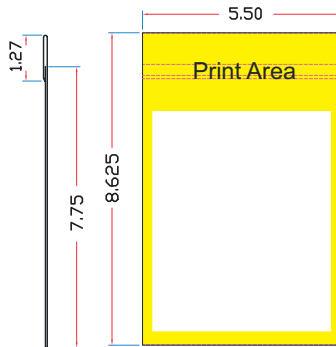

Die No.	Overall size		Ticket size	
	W"xH"	Top fold	Bottom fold	W"xH"
KK0125	5.5"x8.625"	1.25"	7.75"	5.5"x8.5"

25

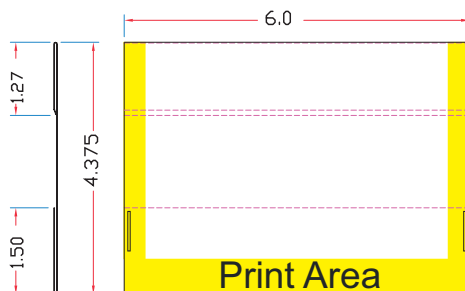

Die No.	Overall size		Ticket size	
	W"xH"	Top fold	Bottom fold	W"xH"
KK0031	6"x 4.375"	1.25"	1.5"	5.5"x4.25"

Note: Ticket pocket welded on left side and right side

26

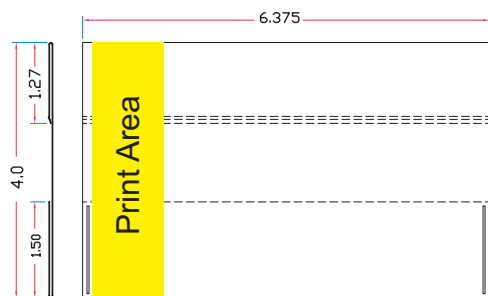

Die No.	Overall size	Top fold	Bottom fold	Ticket size
	W"xH"			W"xH"
KK0155	6.375"x 4.0"	1.25"	1.5"	6.0"x3.875"

Note: Ticket pocket welded on left side and right side

27

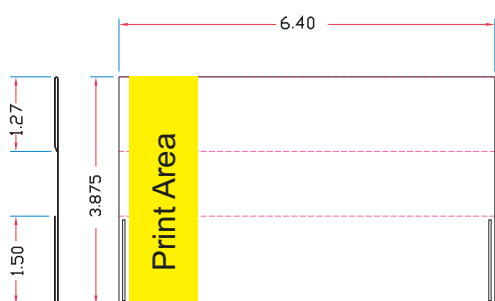

Die No.	Overall size	Top fold	Bottom fold	Ticket size
	W"xH"			W"xH"
KK1007	6.4"x3.875"	1.25"	1.5"	6.0"x3.75"

Note: Ticket pocket welded on left side and right side

28



Die No.	Overall size	Top fold	Bottom fold	Ticket size
	W"xH"			W"xH"
KK0161	8.5"x2.875"	1.25"	2.0"	8.5"x2.75"

29

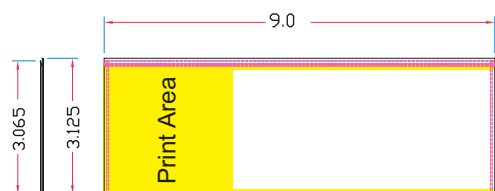

Die No.	Overall size	Top fold	Bottom fold	Ticket size
	W"xH"			W"xH"
KK0163	9.0"x 3.125"	N/A	3"	8.5"x2.75"

Note: Ticket pocket welded on left side and right side

30

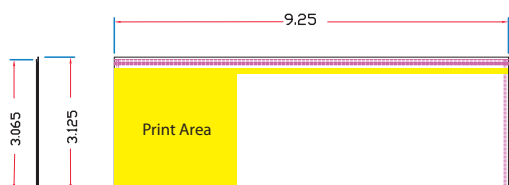

Die No.	Overall size	Top fold	Bottom fold	Ticket size
	W"xH"			W"xH"
KK0133	9.25"x3.125"	N/A	3"	8.5"x2.75"

Note: Ticket pocket welded on left side and right side

31

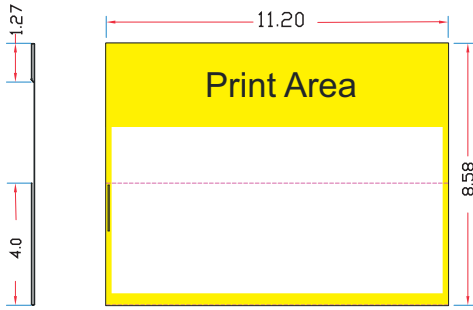

Die No.	Overall size		Ticket size	
	W"xH"	Top fold	Bottom fold	W"xH"
KK0113	11.2"x 8.58"	1.25"	4"	11"x8.5"

Note: Ticket pocket welded on left side

32

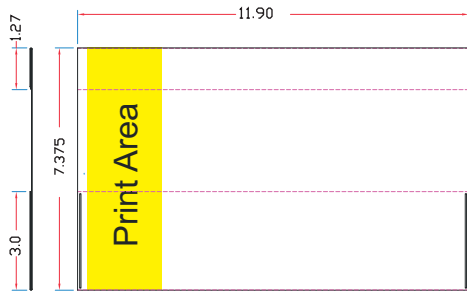

Die No.	Overall size		Ticket size	
	W"xH"	Top fold	Bottom fold	W"xH"
KK1010	11.9"x 7.375"	1.25"	3"	11.5"x7.25"

Note: Ticket pocket welded on left side and right side

33

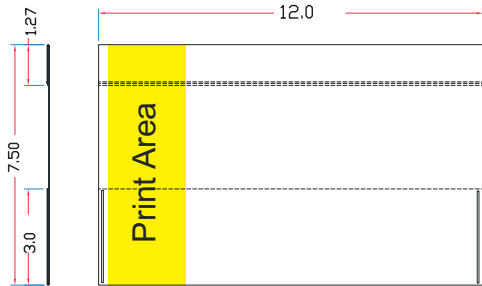

Die No.	Overall size		Ticket size	
	W"xH"	Top fold	Bottom fold	W"xH"
KK0156	12"x 7.5"	1.25"	3"	11.625"x7.25"

Note: Ticket pocket welded on left side and right side

34

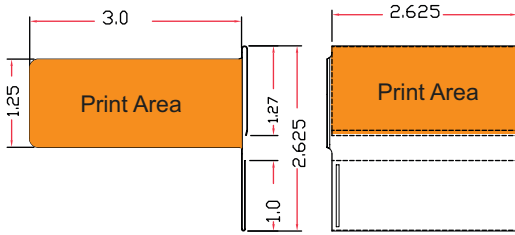

Die No.	Overall size	Top fold	Bottom fold	Ticket size
	W"xH"			W"xH"
KK0078	2.625"x 2.625"	1.25"	1"	2.375"x1.25"

Note: Ticket pocket welded on left side

35

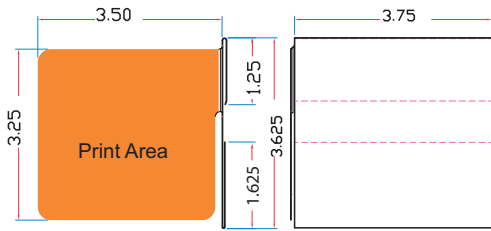

Die No.	Overall size	Top fold	Bottom fold	Ticket size
	W"xH"			W"xH"
KK0052	3.75"x 3.625"	1.25"	1.625"	3.75"x3.5"

Note: Ticket pocket welded on left side

36

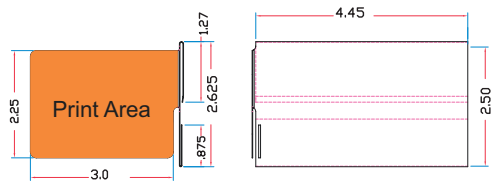

Die No.	Overall size	Top fold	Bottom fold	Ticket size
	W"xH"			W"xH"
KK0089	4.45"x 2.625"	1.25"	0.875"	4.25"x2.5"

Note: Ticket pocket welded on left side

37

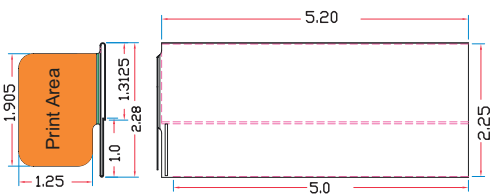

Die No.	Overall size	Top fold	Bottom fold	Ticket size
	W"xH"			W"xH"
KK0164	5.2"x 2.25"	1.25"	1"	5"x2.25"

Note: Ticket pocket welded on left side

38

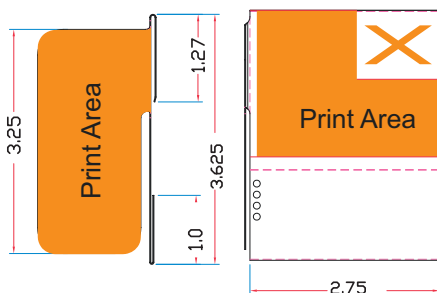

Die No.	Overall size	Top fold	Bottom fold	Ticket size
	W"xH"			W"xH"
KK0096	2.75"x 3.625"	1.25"	1"	2.5"x1.25"

Note: Ticket pocket welded on left side

39

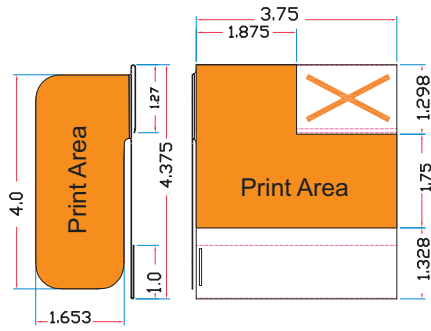

Die No.	Overall size		Ticket size	
	W"xH"	Top fold	Bottom fold	W"xH"
KK0040	3.75"x 4.375"	1.25"	1"	3.65"x1.25"

Note: Ticket pocket welded on left side

40

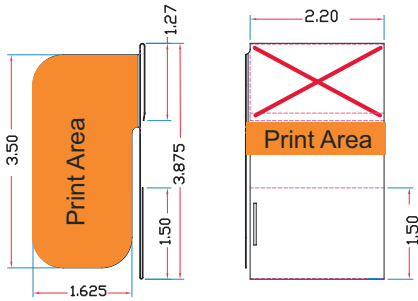

Die No.	Overall size		Ticket size	
	W"xH"	Top fold	Bottom fold	W"xH"
KK0050	2.2"x 3.875"	1.25"	1.5"	2"x2"

Note: Ticket pocket welded on left side

41

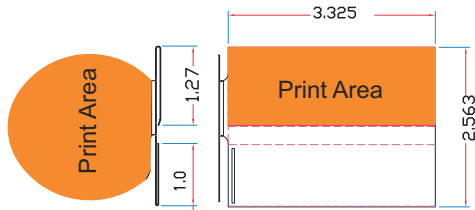

Die No.	Overall size		Ticket size	
	W"xH"	Top fold	Bottom fold	W"xH"
KK0129	3.325"x 2.563"	1.25"	1"	3.125"x1.25"

Note: Ticket pocket welded on left side

42

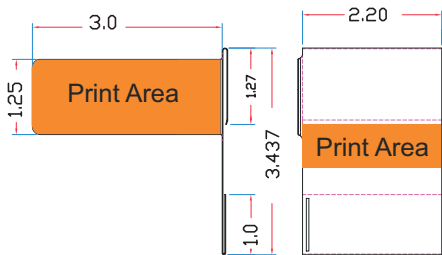

Die No.	Overall size		Ticket size	
	W"xH"	Top fold	Bottom fold	W"xH"
KK0103	2.2"x 3.437"	1.25"	1"	2"x1.25"

Note: Ticket pocket welded on left side

43

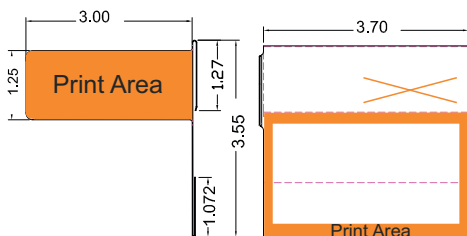

Die No.	Overall size		Ticket size	
	W"xH"	Top fold	Bottom fold	W"xH"
KK0110	3.7"x 3.55"	1.25"	1.072"	3.5"x2.2"

Note: Ticket pocket welded on left side

Signature Series | Preprinted shelf edge product focus.

As a quick alternate to the semi-custom part shape choices in this catalog, kostklip® also offers the preprinted Signature Series ShelfTalkers™. These pre-printed plastic shelf edge signs are designed to efficiently clip into the clear window of kostklip's **ClearVision®** non-adhesive ticket moldings. The result is an eye-catching, low cost, professional shelf edge marketing program that can maximize product focus and increase product sales!

2 designs, 8 different messages, in-stock now!

Signature Series products are **in-stock** and ready to ship to you today! The line-up consists of bib signs and bibs with right angle flags, in 8 different messages.

Infinity Series™ | Custom designed ShelfTalkers™ also available

Need to extend your brand to the shelf edge? Send us the graphics, part shape and color specifications, and we'll create a matching ShelfTalker™ program! Minimums apply. Contact us for details!

Bib signs



Code	Message	Description	Color	Pack
103825	Sale	2.5"W x 3"H	red/white	100
103826	New Item	2.5"W x 3"H	red/white	100
103824	Low Price	2.5"W x 3"H	red/white	100
103829	In-Store Special	2.5"W x 3"H	red/white	100
103827	Double your Points	2.5"W x 3"H	red/white	100
103828	blow out!	2.5"W x 3"H	red/white	100
103831	Organic	2.5"W x 3"H	green/white	100
103830	Locally Produced	2.5"W x 3"H	green/white	100

Bib with Right Angle Flag



Code	Message	Description	Color	Pack
103832	Sale	2.5"W x 3"H	red/white	100
103834	New Item	2.5"W x 3"H	red/white	100
103833	Low Price	2.5"W x 3"H	red/white	100
103837	In-Store Special	2.5"W x 3"H	red/white	100
103835	Double your Points	2.5"W x 3"H	red/white	100
103836	blow out!	2.5"W x 3"H	red/white	100
103839	Organic	2.5"W x 3"H	green/white	100
103838	Locally Produced	2.5"W x 3"H	green/white	100



Price tickets are dimensioned as noted above - width x height

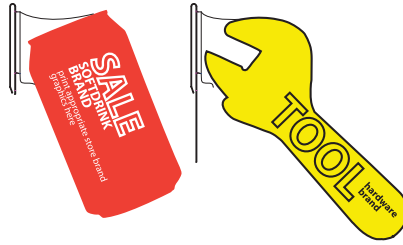

Beyond the standard ShelfTalker shapes in this catalog, kostklip can manufacture almost any other custom shape - just submit your requirements to us!



Installation of a **ShelfTalker™** is quick & easy!

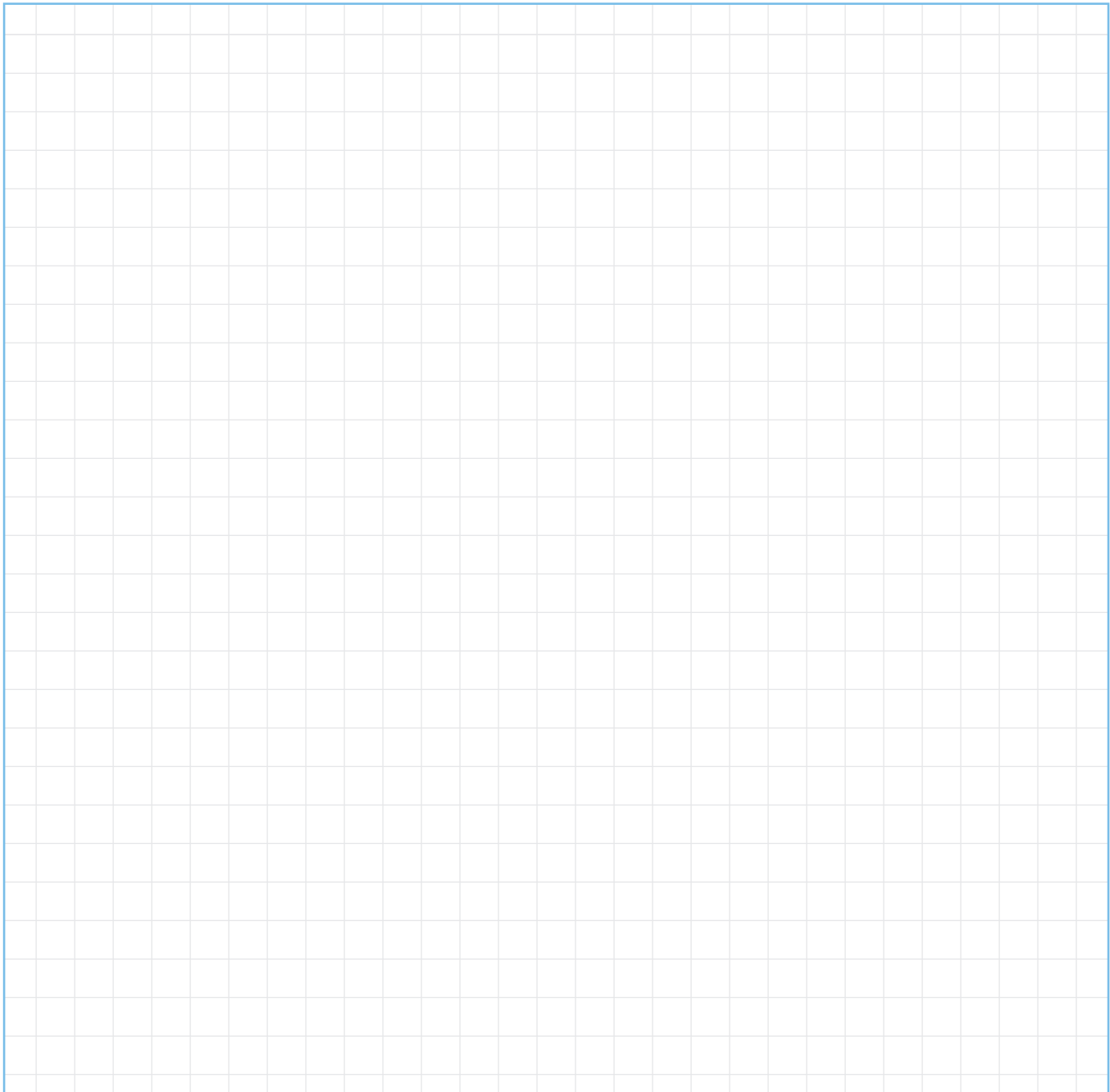



Sales: 1.800.661.5547

sales@kostklip.com

119-1611 Broadway St.

Port Coquitlam BC V3C 2M7

www.kostklip.com

Please contact us for more information about your specific requirements or how ShelfTalkers™ can help generate product focus and sales uplift.