

LIQUOR RETAILER MERCHANDISING SOLUTIONS



kostklip[®]
LIFE AT THE SHELF EDGE

Toll-Free North America 1.800.661.5547

Kost Klip Manufacturing Ltd. | sales@kostklip.com | www.kostklip.com



TABLE OF CONTENTS

- Introduction..... Page 3
- Shelf Label Strips..... Page 4
- Additional Shelf Edge Accessories..... Page 6
- ChalkTalker™..... Page 14
- ChipTalker™..... Page 15
- ShelfTalkers™..... Page 16
- Infinity Series ShelfTalkers™..... Page 18
- ShelfTalkers™ Implementation..... Page 19



INTRODUCTION

Kostklip® is pleased to introduce our Liquor Retailer Merchandising Solutions program, created to provide you with one-stop retailer marketing solutions, specifically for all areas of your store.

Maximize sales with shelf management solutions that will maintain clean and organized shelves throughout the store. Easily improve visibility of products that are organic, local, gluten free or on sale to assist your customers' ability in selecting the products that meet their requirements, while enhancing their shopping experience. Or just find new ways to display your prices.

This brochure is just a part of our idea book, a starting point to help you merchandise your stores, because we believe in creating customized solutions based on your needs.

SHELF LABEL STRIPS



Flat Mount Ticket Molding



ClearVision® and ClearGrip™ Flat Mount Ticket Molding are shelf edge labeling systems for retailers. The clear window of a ticket molding holds, displays and protects paper price tickets. Mounts to any clean surface and maintains the existing shelf edge angle.

* Contact us for more color, size and tape options

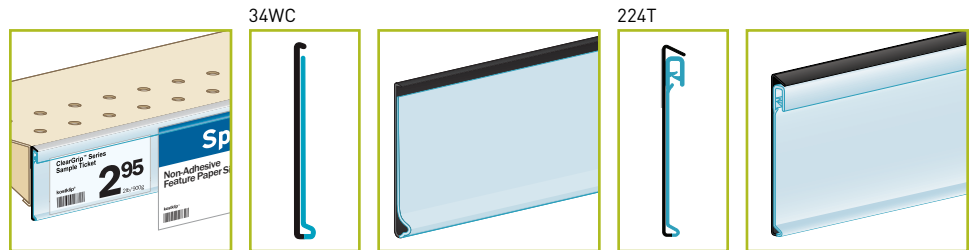

FlexChannel®



FlexChannel® is an innovative, one-size-fits-all price channel ticket molding that helps Liquor Stores reduce ticket molding SKUs when implementing a shelf edge labeling program in their store chain. It clips into most standard C-channel shelving.

* Contact us for custom colors and lengths

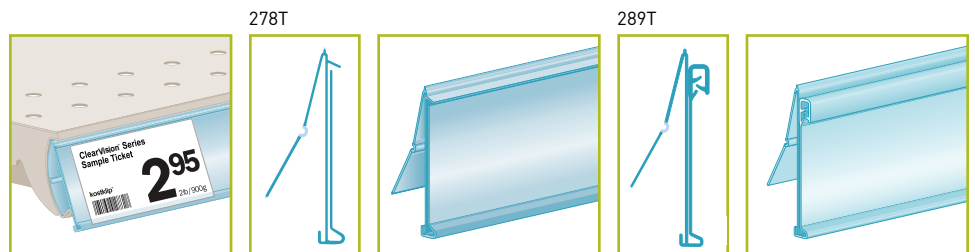

FlexKlip® Shelf Edge Adapter



FlexKlip® shelf edge adapters create a universal C-channel on various fixtures throughout the store, eliminating the need to purchase add-on PTMs from shelf manufacturers. FlexChannel® ticket molding eliminates the need for different back leg sizes, custom colors and lengths because it's a one-size-fits-all solution for all price channel applications.

Types of Fixtures

LARGE RATCHET	SMALL RATCHET	DUAL ANGLE	WIRE FENCE	GLASS & WIRE SHELF
Metro® Wire Shelving	Double Wire Shelving	Lozier® C-Channel	Wire Fence & Basket	FlexKlip® Glass & Single Wire Adapter (Up to 0.5" thick)
Husmann® Aluminum PTM	Husmann® Bullnose	Husmann® C-Channel PTM	Vertical Glass	
Bare Kysor/Warren®	Zero Zone® Bullnose	Hill-Phoenix® C-Channel PTM		



PerfPaper™ (107P)

This micro-perforated paper is specifically designed with a high moisture content to avoid drying out and curling after printing. It's also milled with a smooth surface that allows for better adhesion to toner. These qualities are especially beneficial to obtain the best clarity for printed bar codes as well as handling tickets during installation.

* Custom pre-printed options available

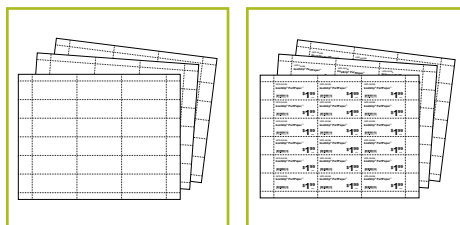

ADDITIONAL SHELF EDGE ACCESSORIES



Clip-Over, Top Position ShelfTalkers™ (CVTM)

This interchangeable, reusable plastic shelf edge sign cover is designed to easily clip into the window of any ClearVision® ticket molding and maintains the existing shelf edge angle. This result is an eye-catching, low cost, professional marketing program that allows you to display branding or a variety of messages in store.

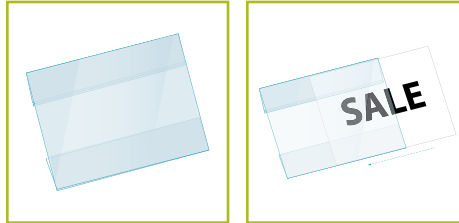

Three Sided Sealed Sign Protector (SPRO)

Sign protectors help prevent paper signs from getting damaged and maintain a professional look. Use the Three Sided Sign Protector to display signs for different applications around your store.

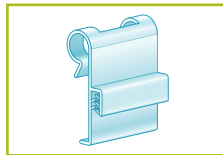
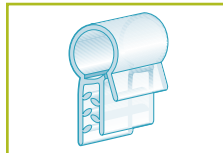

Fence & Basket Sign Grip (90FG & 94FG)

This sign clip & grip is available in single, double, and triple loop options. Use this clip to secure signage onto wire fence shelving behind beverage bottles, or to grip onto open cardboard boxes. Use with kostklip's sign sleeves or protectors to protect your paper signs.

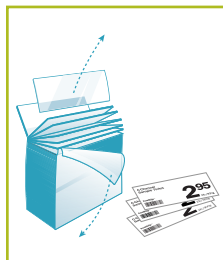

Price Channel Label Protector, Precut (26PC)

Made with high gloss PVC for durability and high impact resistance. Recommended to cover standard 1.25" H channel price label in all areas, including areas where moisture damage can occur. It protects non-adhesive price label from damage, moisture, soiling and/or mishandling. Convenient and easy to apply.

ADDITIONAL SHELF EDGE ACCESSORIES



Pallet Display Wedge, Flush Grip (183S)

The pallet display slips in between stacks of boxes to display aisle specials or sale signs. The PowerGrip® holds signs up to 0.06" thick and can be used in the down or up position.

* Contact us for custom sizes and colors

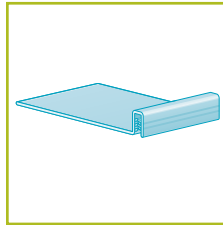

L-Style & T-Style, One-Piece

Made from 0.060" PETG which has good optical properties, a brilliant surface, and high impact resistance. It protects and displays countertop signage. Sign holders are available in a wide range of sizes and in portrait or landscape formats.

* Call us for more details.

ESLS

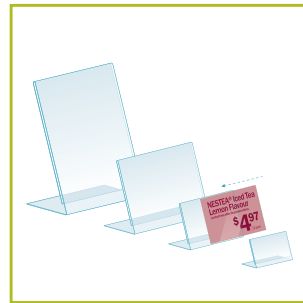

TLTS

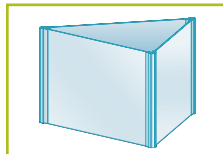

TriVision™ Three Sided Sign Holder (TSTV)

The three-sided sign holder consists of three SPRO sign protectors and three connector hinges. Simply insert your paper signs into the sign protector then attach each end to the connector pieces.

It's perfect for placing on top of pallet displays or other areas where customers view the merchandise from multiple angles.

ADDITIONAL SHELF EDGE ACCESSORIES



TwistKlip™ Large Clip with Large Claw (124E)

Kostklip's TwistKlips™ are versatile sign holders for an endless number of applications. Our all-plastic TwistKlips™ are rust-proof and wash down so it can be used for open food and liquor tasting areas. The large claw has a firm grip and attaches almost anywhere for your in-store signage needs. The clear top creates maximum readability to inform your customers about your merchandise. Combine the TwistKlip™ with one of our sign protectors to protect your paper signs from damage.



Counter Top Sign Holders

Kostklip's sign holders are perfect for liquor store counter tops and shelves to display product information, tasting notes, or store specials. Use with kostklip's sign sleeves or protectors to protect your paper signs.

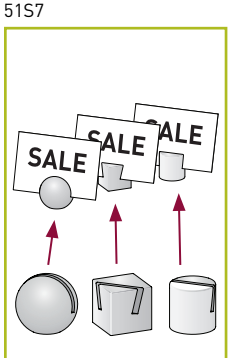
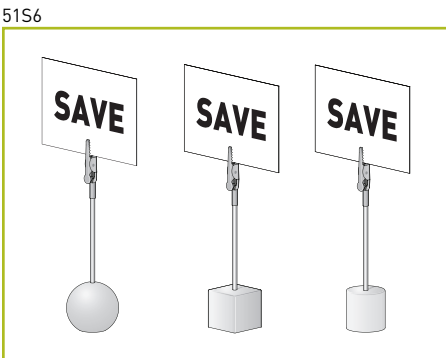

ADDITIONAL SHELF EDGE ACCESSORIES



Telescopic Pallet Sign Holder (TPSH)

Use the sleek and adjustable pallet sign holder to display signage around your store. The large, low-profile base secures the sign holder under pallets, crates and other in-store displays. It has an adjustable height (48-82"H in 2" increments) and the arm can rotate in 90° positions.

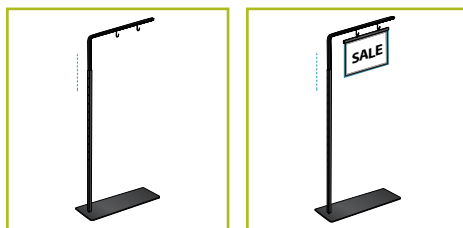

Indoor WalkTalker™ Sign Holder (IWT1 & IWT2)

Constructed from black powder coated steel, the Indoor WalkTalker™ Sign Holder holds printed signs 22"W x 28"H. Its includes a hex key & hardware for easy assembly.

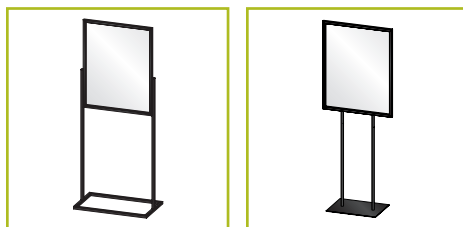

Outdoor WalkTalker™ Sign Holder (SFSH)

The Outdoor WalkTalker™ Sign Holder is wind and water resistant. The fillable base can be used with water or sand to give it a weighted base. It also has spring loaded stems, allowing give in strong winds.

* Also available in grey



ADDITIONAL SHELF EDGE ACCESSORIES

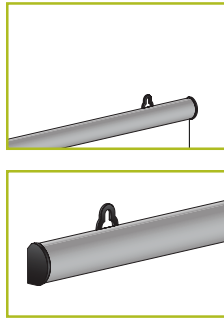

Aluminum Banner Hanger with Eyelets Sign Holder (ALBH)

Made with aluminum with a brushed finish, it comes with removable eyelets and end caps for easy installation. The internal rubber grip helps to secure and suspend signage up to 3/16" thick.

* Signs not included



Right Angle Aisle Sign Holders

Kostklip's aisle sign holders allows you to display large signs and advertisements in the aisles. The strong grip on the PowerGrip® allows for big, heavy signs.

HCSH

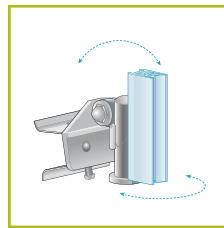

BR04

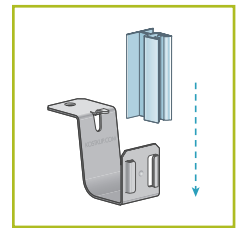
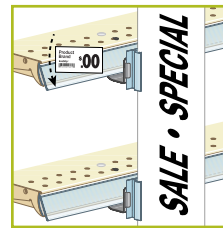

TMCH

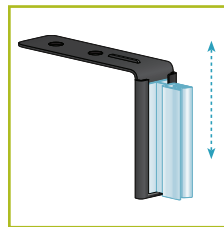
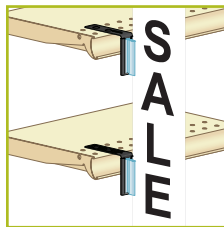

98TG

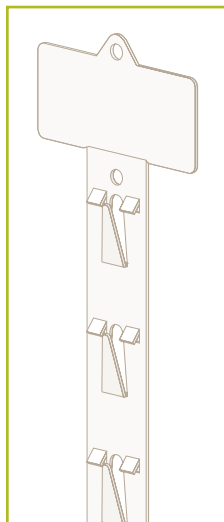
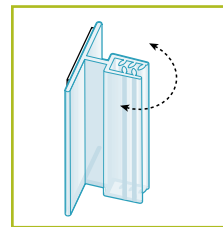

Merchandise Strip, Light Duty, 12 Tabs, with 3"W Header (MSTH)

The merchandise strip features 12 product tabs with 3"W header to place adhesive ticket labels. It is made from 0.05 polypropylene material and holds more weight than conventional die-cut strips. It features a 0.375" hole punch located top center.

ADDITIONAL SHELF EDGE ACCESSORIES



2-in-1 Magnetic Divider (TLD1, TLD3 & TLD5)

Our SKU reducing, innovative, tear-away dividers allow for time-saving and convenient installment and optimal product allocation. Easily convert a T-divider into an L-divider to fill product right to the ends of the shelf.

Enhance your customer's experience by maintaining clean and organized shelves throughout the store.

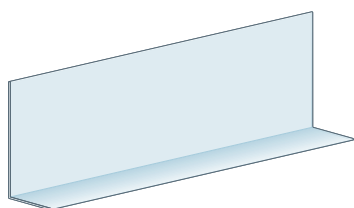
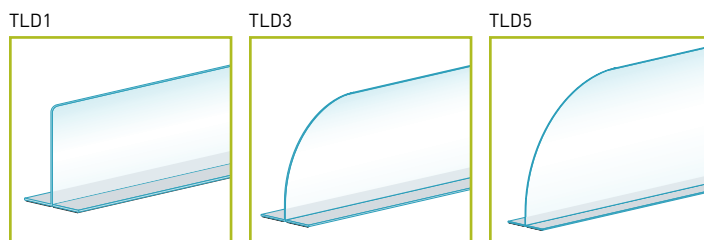

L-Bracket Display Builder (34LB)

Made from extruded PVC for durability and high impact resistance the L-Bracket Display Builder can be used to build merchandising displays and front fence.

* Custom lengths available

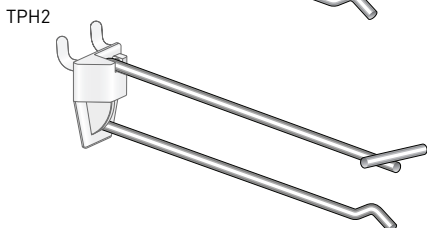
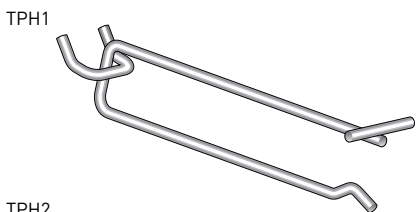

T-Style Scanning Hooks

Made from zinc plated, galvanized wire for optimal corrosion resistance. It fits a pegboard or a slat wall, with a 0.187" diameter wire.

* Contact us for compatible parts

ADDITIONAL SHELF EDGE ACCESSORIES



EasyRoller™ (GFRT)

The EasyRoller™ is the ideal gravity feed solution for automatically front facing products. Typically used with bottles, cans and other flat based packaging, the EasyRoller™ keeps your shelves always presentable. Stock-outs can be spotted instantly, and re-stocking is a breeze.

The EasyRoller™ can easily be installed on existing shelving with the provided angle adaptors or on custom angled shelving.

Available in convenient 11.7" wide sections or custom widths for all types of shelves.

REDUCE LABOUR COSTS

ENHANCE PRODUCT PRESENTATION

IMPROVE INVENTORY CONTROL

EASY INSTALLATION

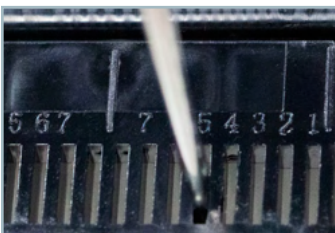

NUMBERED DIVIDER INSERTS

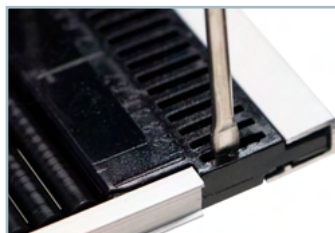

EASY TO INSTALL WIRE DIVIDERS

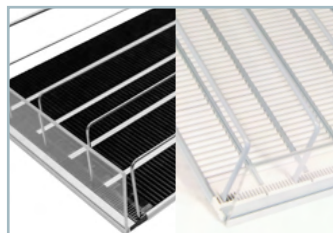

AVAILABLE IN BLACK OR BEIGE

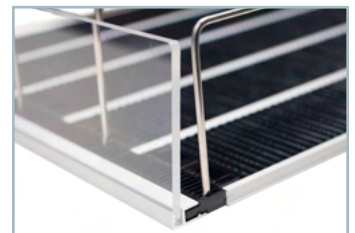

CLEAR FRONT FENCE AVAILABLE IN VARIETY OF SIZES

Wire Divider Systems

Kostklip's manufacturing capabilities include plastic, print and metal & wire products. Whether it be a wire fence, basket or custom design, kostklip® works with you to create the perfect solution for your merchandising needs. Choose from one of our in-stock products or call to have something made to order for your specific requirements.

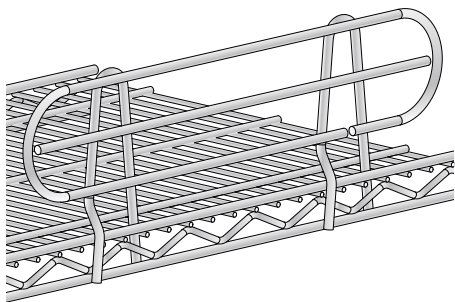

Wire Ledge for Metro® Shelf Management (WFMS)

Attaches to the front, back and sides of all Metro® style wire shelves. Easy to attach to shelves – no tools required and it prevents products from falling off shelf.

- * Custom lengths and styles available
- * Call for more details

CONTACT US FIND OUT MORE ABOUT
OUR WIRE FENCE OPTIONS





ChalkTalker™ Bib (CVCT & CGCT)

Kostklip's innovative ChalkTalker™ Bibs were designed for retailers looking for an easy-to-use, reusable option to display marketing and promotional messages along the shelf edge. Kostklip's reusable ChalkTalkers™ provide retailers a solution that saves on operational costs, while reducing in-store carbon footprints with non-adhesive in-store signage solutions.

CVCT

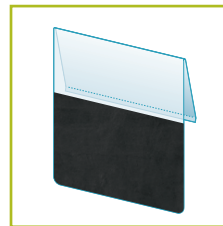

CGCT

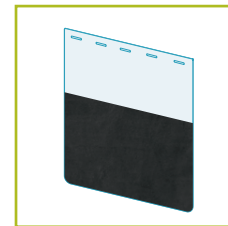

ChalkTalker™ Deli Signs

Made from impact resistant, black PVC. Printed with a woodgrain border. When used with kostklip's ChalkTalker™ pens to create customized messages, it can easily be cleaned with alcohol wipes or spray.



ChalkTalker™ Pens (CP01)

Combine kostklip's ChalkTalker™ Bibs with ChalkTalker™ pens to create customized messages. Easily clean ChalkTalker™ surface with alcohol spray or wipes. The ink is waterproof and quick-drying. The set includes two white pens and three additional fun colors (pink, blue, silver).



Under certain circumstances it may be difficult to remove the writing. Recommended alcohol cleaning percentage is 91% USP.



ChipTalkers™ (CH1P)

Made from high impact resistance PVC, the ChipTalkers™ slips into either the clear 1.25”H window of any ClearVision® ticket molding or into bare C-channel shelving. Each kit contains a variety of promotional, health and lifestyle messages. Perfectly compliments kostklip’s ShelfTalkers™.

Promotional Kit



Lifestyle and Health Kit



SIGNATURE SERIES SHELFTALKERS™

Signature Series ShelfTalkers™ are colorful, reusable, printed plastic shelf edge signs that are designed to be quickly inserted anywhere along the shelf edge with kostklip's ClearGrip™, ClearVision® or Flex Series non-adhesive ticket molding. The result is an eye-catching low cost, professional shelf edge marketing program that can maximize product focus and increase product sales! Use with our 2.5"W x 1.25"H PerfPaper™ (107P-101164).

TYPES OF MESSAGES

- SALES PROMOTIONS
- PRODUCT INFO
- HEALTH & NUTRITION INFO
- LOYALTY PROGRAMS
- PRIVATE LABELING

why replace adhesive shelf talkers?

- Cleaner – No adhesive residue to scrape
- Durable – Bibs don't rip, curl or tear
- Reusable – Less waste, more recycling
- Colorful – Bold graphics and high quality print

features

- Suitable for 2.5"W x 1.25"H printed paper tickets
 - Printed message bib area is approximately 2.5"W x 1.75"H
 - Freezer and refrigerator temperature compatible
 - Durable heat-folded recyclable high gloss PVC material
 - Clips into 1.25"H ClearVision® or ClearGrip™ ticket molding
- » Use PerfPaper™ 2.5"W x 1.25"H (107P-101164)

ClearVision®

Available in bib and bib with right angle flag



ClearGrip™

Available in bib and bib with right angle flag





ShelfTalker™ for ClearVision® & ClearGrip™ Ticket Molding

Comes in Packs of 25



◆ S100-107126
◆ S500-107141



◆ S101-107192
◆ S501-107208



◆ S102-107127
◆ S502-107142



◆ S103-107193
◆ S503-107209



◆ S104-107128
◆ S504-107143



◆ S105-107194
◆ S505-107210



◆ S106-107129
◆ S506-107144



◆ S107-107195
◆ S507-107211



◆ S108-107130
◆ S508-107146



◆ S109-107196
◆ S509-107212



◆ S110-107131
◆ S510-107147



◆ S111-107197
◆ S511-107213



◆ S112-107132
◆ S512-107148



◆ S113-107198
◆ S513-107214



◆ S114-107133
◆ S514-107149



◆ S115-107199
◆ S515-107215



◆ S116-107134
◆ S516-107150



◆ S117-107200
◆ S517-107216



◆ S118-107135
◆ S518-107151



◆ S119-107201
◆ S519-107217



◆ S120-107136
◆ S520-107152



◆ S121-107202
◆ S521-107218



◆ S124-107138
◆ S524-107154



◆ S125-107204
◆ S525-107220



◆ NS23-108681
◆ NS33-108687

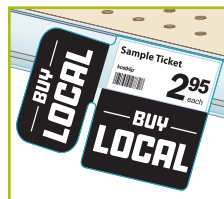

◆ NS13-108675
◆ NS43-108693



◆ NS25-108683
◆ NS35-108689



◆ NS15-108677
◆ NS45-108695

Comes in Packs of 100



◆ S126-107139*
◆ S526-107155*



◆ SSGC-103826

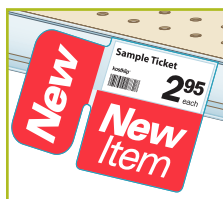

◆ SSGD-103834



◆ SSI6-106679

INFINITY SERIES SHELF TALKERS™



Infinity Series ShelfTalkers™

Infinity Series ShelfTalkers™ are custom printed and manufactured in-house so we can produce almost any shape, size or color!

- Communicate your brand message
- Promote your private label
- Color-match graphics
- Develop a custom shape
- Create an in-store campaign

Whatever the requirements, kostklip® can deliver custom programs for any number of stores in your chain.

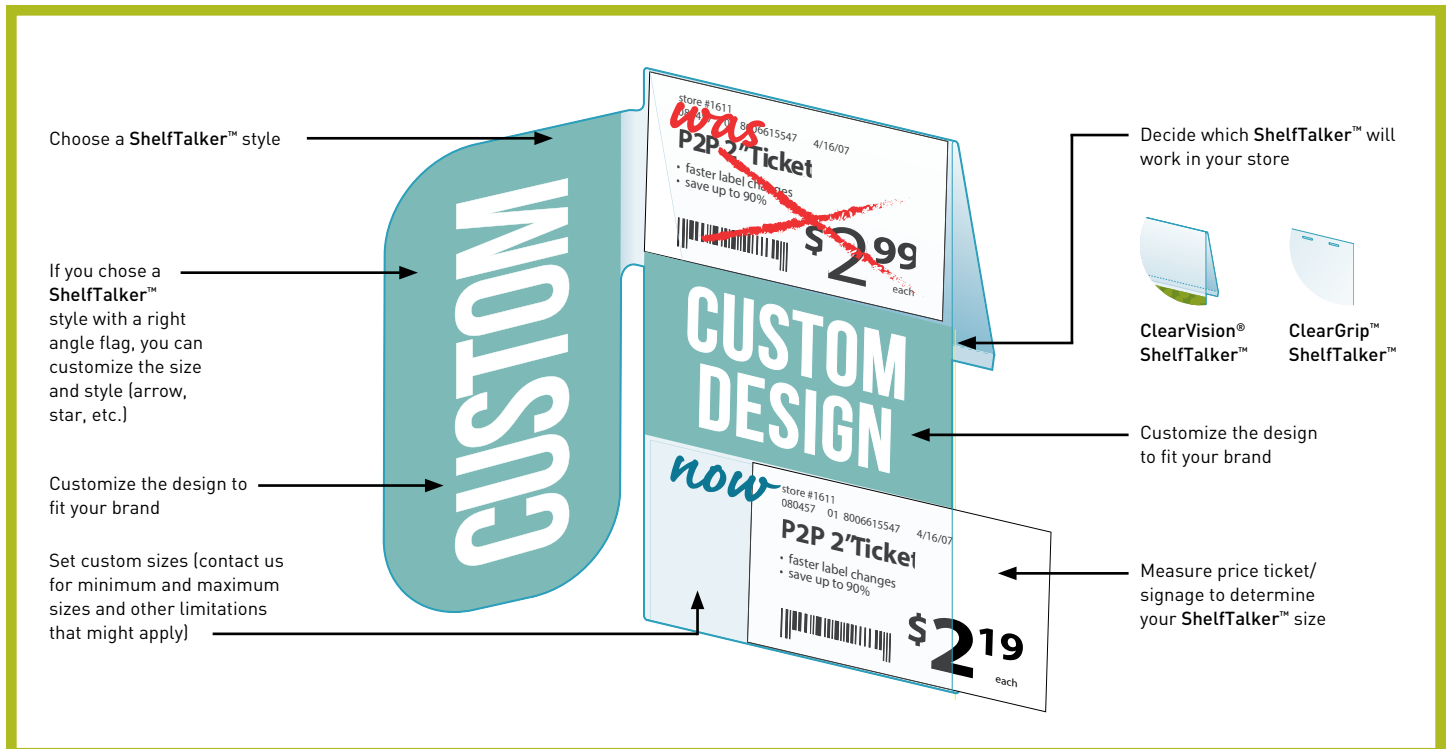

SHELF TALKERS™ IMPLEMENTATION

Before and After using customers' existing tickets with kostklip® ClearVision® FlexChannel® Ticket Molding and Signature Series ShelfTalkers™.

BEFORE...



...AFTER



SIGN UP TO OUR NEWSKlips & RECEIVE **10% OFF** YOUR FIRST ORDER

NewsKlips provides industry trends in product merchandising, ways to optimize in-store customer experiences, new product alerts, promotions, and sales as well as contests and giveaways.

* Visit www.kostklip.com and subscribe. A promo code will be sent once you have signed up to kostklip's NewsKlips.

CONTACT US TODAY

Call us today to learn more about our Liquor Store Program!

IT'S EASY TO ORDER

CHOOSE ONE OF THE FOLLOWING METHODS:



Call Toll-Free
North America wide
1.800.661.5547



Fax your purchase order to
1.877.468.0007



Visit our website,
log in & order online
www.kostklip.com



Email your purchase order to
sales@kostklip.com



Hours of Operation
7:30 am – 4:00 pm
Pacific Time

kostklip®
LIFE AT THE SHELF EDGE

1.800.661.5547 | sales@kostklip.com | www.kostklip.com
119-1611 Broadway St, Port Coquitlam BC V3C 2M7

Liquor Store_Brochure_VSN 7 | Printed in Canada

FOLLOW US ON



@kostklip



@kostklip



@lifeattheshelfedge



kostklip®



kostklip®



kostklipShelfEdge