



# ProMix<sup>®</sup> 2KS and 3KS

Two- and Three-Component Electronic Proportioning System



PROVEN QUALITY. LEADING TECHNOLOGY.

# Increase Efficiency and Productivity!

## Graco's Electronic Proportioners

ProMix® 2KS offers precise and reliable electronic proportioning for a broad range of solventborne, waterborne and acid catalyzed materials.

From entry level to upgraded applications, the ProMix 2KS provides flexibility and increased efficiency – including optimized flushing sequences and an optional third purge valve to properly manage waterborne urethanes for manual and automatic operation.

## Upgrade to ProMix 3KS

ProMix 3KS offers precision mixing of three component materials and accurately reduces your material to the correct spray viscosity as conditions change.



### ProMix 2KS Features

- Manual and automatic configurations
- Intrinsically safe fluid panels allow for integration into hazardous areas\*
- Single or multi-color and catalysts
- Accurate ratio assurance for superior finish quality
- Simple programming allows fast set up and efficient process control
- Advanced web interface provides consolidated system management and reporting

### Key Materials

- Solventborne epoxies and polyurethanes
- Waterborne epoxies and polyurethanes
- Acid catalyzed materials

### Why Electronic Proportioning?

- Offers the highest degree of ratio assurance
- Provides critical process variable feedback
- Built-in system safeguards
- Effective color change solution
- Efficient material tracking and reporting

\*All accessories and installations need to meet local, state and national codes

# Three Systems in One

## Use up to 30 colors and 4 catalysts

ProMix 2KS is available in a variety of system level configurations. Each one includes an EasyKey™ display along with a Smart Fluid Panel. Color and catalyst change is easily integrated with a plug-and-play control module and valves.

1

### Manual Wall Panel

Manual systems benefit from an additional Remote Operator Station that allows fingertip control inside the spray booth.

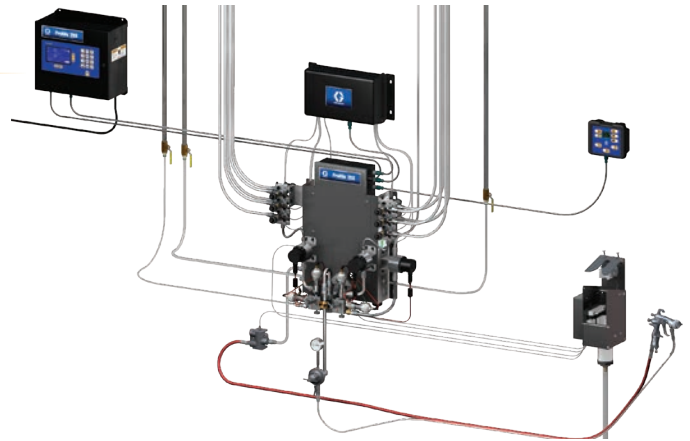

2

### Automatic Wall Panel

Optional flow control is cleanly integrated without incorporating a mixed material line meter. Pressure and flow loops provide fast step changes with superior closed loop control.

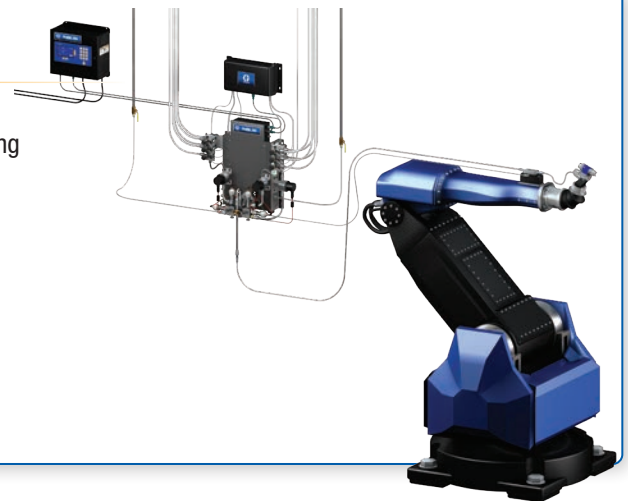

3

### Automatic RoboMix Panel

This fluid panel can be easily integrated near the spray gun for a shorter mixed material line, faster color changes and less waste. Also available with flow control.



# Simple & Efficient Operation

High-ratio assurance with easy-to-use components

## EasyKey Display

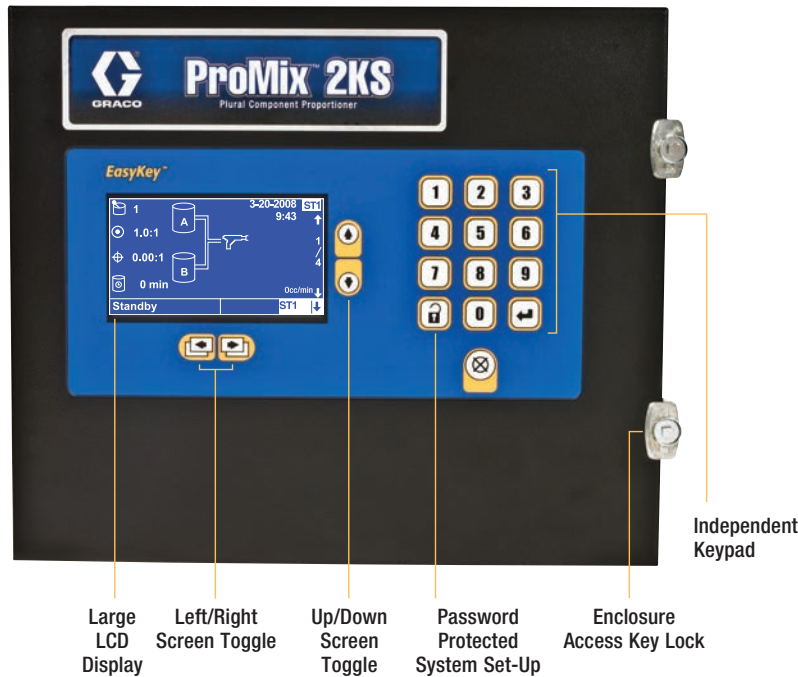

Graco's EasyKey user interface offers simple navigation, multiple language capabilities and a high degree of reliability.

The large LCD display screen is easy to read and operate during machine set up and process monitoring.

The independent touch pad keeps contaminants off the screen while the large keys allow for clear data entry.

## Remote Operator Station

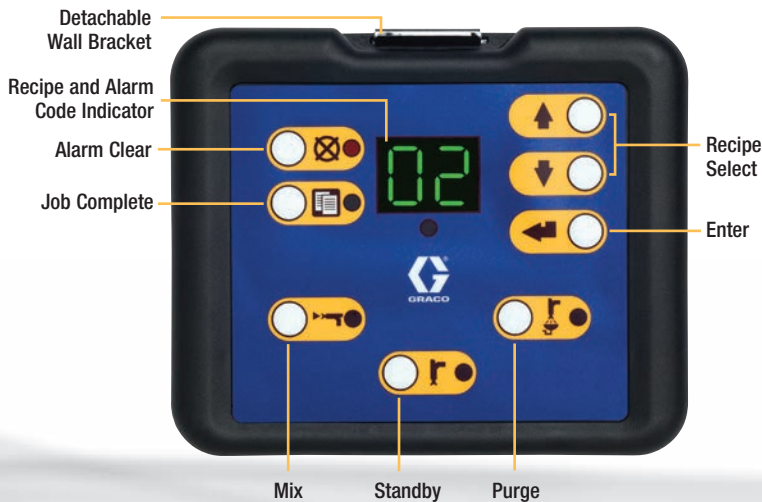

The remote operator station can be mounted inside the spray booth or near the operator for quicker response times.

The station offers easy-to-use controls for mixing, standby, purging, reading/clearing alarms, inputting job complete and recipe select functions.

# Unmatched Functionality

## Wall & RoboMix Fluid Panel Features

### Productive Panels

Intrinsically safe fluid panels offer increased proportioning and flushing functionality, resulting in improved process performance.

### Versatile Dosing

Multiple sequential dose sizes allow the system to meet a broad range of applications without sacrificing performance and quality. Dynamic dosing provides additional proportioning technology to meet unique applications needs.

### On-Ratio Performance

Volume based dosing provides exceptional ratio accuracy across varying flow rates or gun triggering conditions. On-the-fly monitoring and compensation enhance performance and finish quality.

### Consistent Mix Quality

Optimized mix chamber hardware, along with high-speed processors and dispense valves, generate precise performance and consistent, high quality mixed material.

### Fast Color Change with Reduced Waste

New fluid manifold design reduces material volume and streamlines fluid porting for cleaner flushing. Manifold dump valves allow simultaneous purging and loading – reducing color change time and providing better waste containment.

#### Wall Panel

- Up to 50:1 mix ratio for a variety of applications
- Up to 4000 psi (275.6 bar) working pressure for single color and catalyst, supports all spray technologies
- Supports two manual spray guns and gun flush boxes



#### RoboMix

- Up to 50:1 mix ratio for a variety of applications
- Up to 250 psi (17.2 bar) working pressure
- Lightweight, compact design allows easier integration closer to the spray gun
- Can be interfaced with manual spray guns



# Fluid Manifold

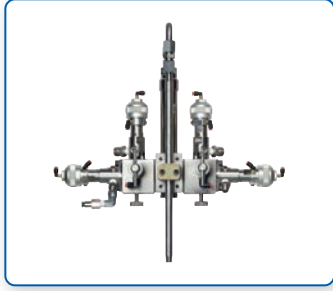

50 cc Integrator

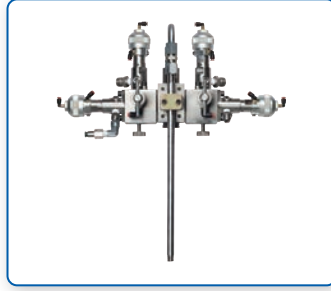

10 cc Integrator

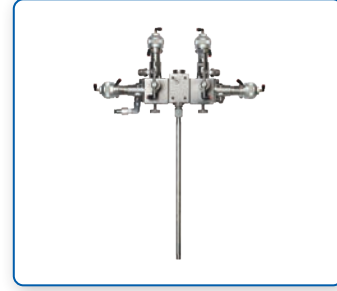

Dynamic Dosing

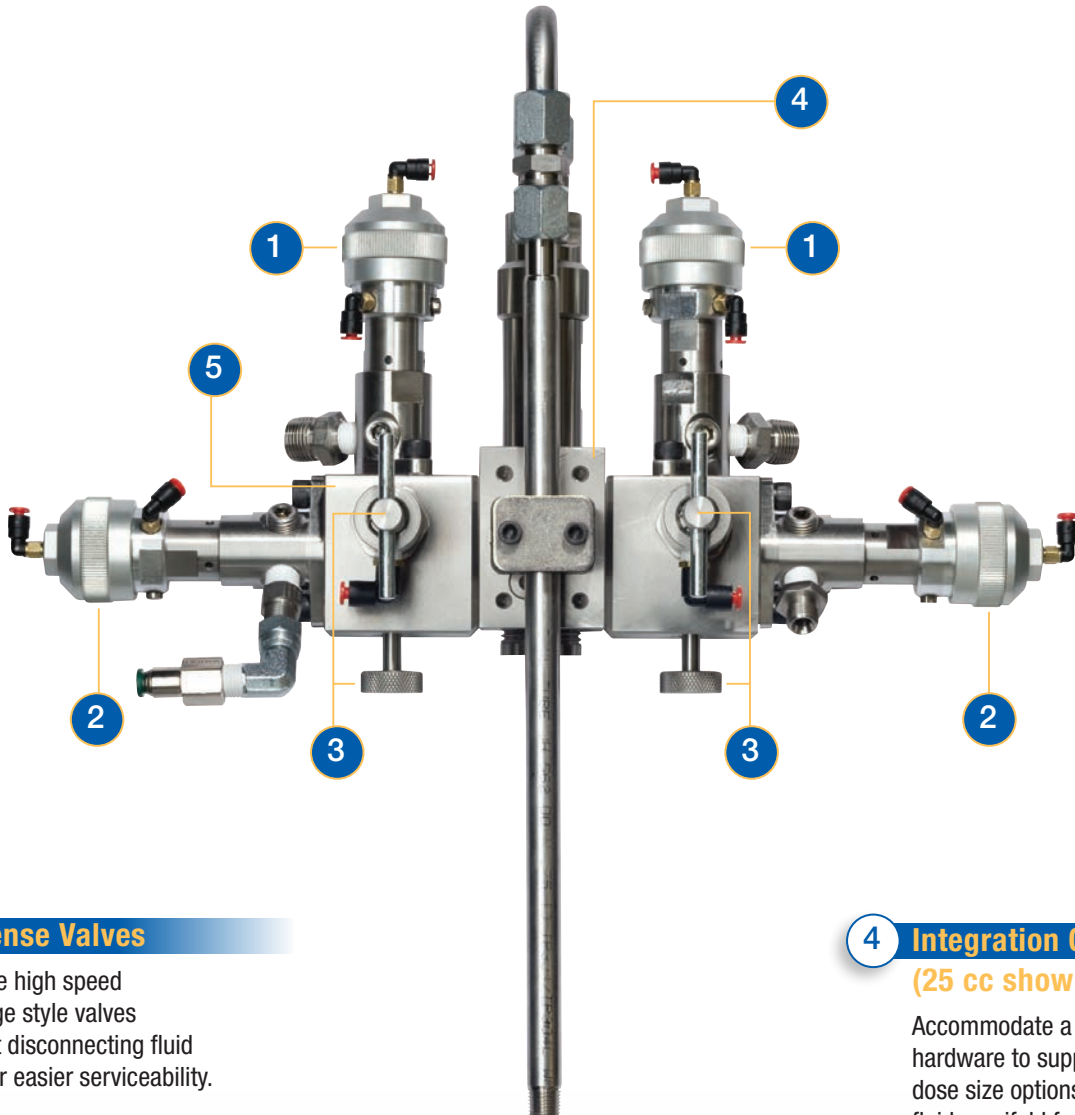

## 1 Dispense Valves

Remove high speed cartridge style valves without disconnecting fluid lines for easier serviceability.

## 2 Manifold Flush Valves

Flush mixed material without wasting premixed resin and catalyst. Add a third valve to the resin side for enhanced flushing, especially with waterborne materials.

## 3 Shutoff and Sample Valves

Ensure accurate volume measurements for meter calibrations and ratio checks with positive shutoff and convenient sampling.

## 4 Integration Chamber (25 cc shown)

Accommodate a wide range of hardware to support multiple dose size options. Optimizes fluid manifold for particular application needs.

## 5 Fluid Porting

Compact, low volume design with no material dead spots, provide faster flushing time and less waste.

# Expanded Options

## Complete Your System!

Today's demanding applications require more than just precise and reliable proportioning from a ProMix 2KS. Graco offers a variety of flow meter technologies and accessories that will enhance your finishing operation.

### Flow Meters

- Complete line of spur gear, helical gear, and non-intrusive Coriolis meters
- Supports a broad range of material types and physical characteristics



G3000 meter



Coriolis meter

### Gun Flush Box

- Automated flushing system for manual spray guns
- Eliminates manual gun triggering for more accurate flushing and filling, and less waste



Gun Flush Box

### Intrinsically Safe Color and Catalyst Change Module

- Provides easy and flexible installation without running long pneumatic lines
- Accommodates future color and catalyst needs with upgradable module



Color Change Module



Low Pressure Color Stack

### Integrated Flow Control

- Eliminates a long pneumatic control line and associated lag with intrinsically safe control module
- Produces quick responses and superior process control with on-board electronics and control hardware
- Provides accurate and consistent flow control for increased material savings

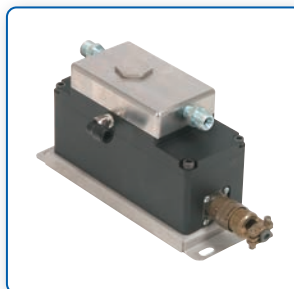

Integrated Fluid Regulator Module



External Fluid Regulator Module

### Advanced Web Interface

- Perform quick and easy system configuration and recipe set up
- Offers convenient process monitoring and streamlines data gathering and reporting
- Manages operations more efficiently by networking multiple ProMix 2KS systems to a single PC

### Communication Gateway

- Provides network integration for automatic systems
- Offers integration flexibility with multiple protocol capabilities
- Reduces installation time with quick plug-and-play set up

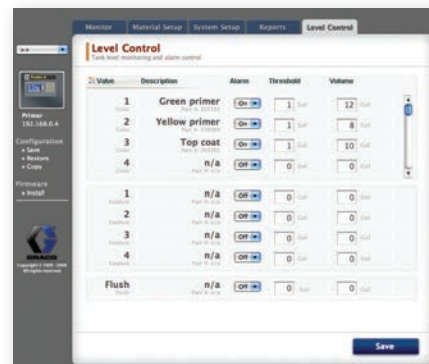

Advanced Web Interface screen shot

# Upgrade to ProMix 3KS

## Precision Mixing of Three-Component Materials

- Manual or automatic operation
- Up to 25 colors, 4 catalysts, and 4 reducers in modular color change system
- Intrinsically safe fluid panel for operation in hazardous areas\*
- Optimized flushing sequences including third flush option

\*All accessories and installations need to meet local, state and national codes

## ProMix 3KS Example System

### Step 1: Identify

Specify your base system.

### Step 2: Upgrade!

Choose the ProMix 3KS Module to fit your system.

T      K      X      X      0      0  
 ↑      ↑      ↑      ↑      ↑      ↑  
 Three Component Meter Color Valves  
 Valves

T	K	Meter	Color Valves	0	0
T	K	0 = No Meter 1 = G3000 2 = G3000 HR 3 = 1/4" Coriolis 4 = S3000	0 = No Valves (single color) 1 = 2 Color LP 2 = 4 Color LP 3 = 2 Color HP 4 = 4 Color HP	0	0

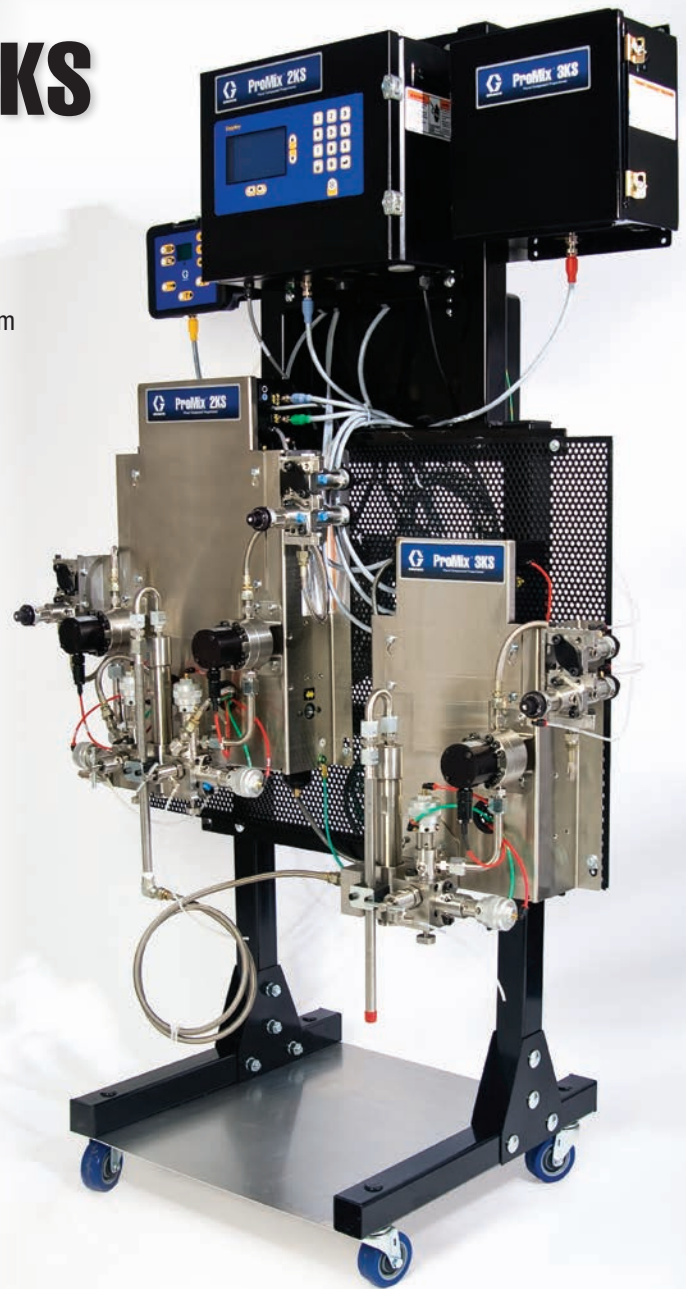

## ProMix 3KS Technical Specifications

Mix Ratio Range*	
Sequential Dosing.....	1st stage: 0.1:1 to 50:1 2nd stage: 0.1:1 to 50:1
Dynamic Dosing .....	1st stage: 0.1:1 to 30:1 2nd stage: 0.1:1 to 30:1
Ratio Accuracy.....	up to + 1% minimum (user selectable)
External Power Supply Requirements .....	85-250Vac, 50/60 Hz. 2 amps max draw, 15 amp circuit breaker required, 8 to 14 AWG power supply wire gauge
Operating Temperature Range .....	41 to 122°F (5 to 50°C)
Noise Level	
Sound pressure level.....	below 70 dBA
Sound power level.....	below 85 dBA
Wetted Parts.....	303 SST, 17-4 SST, PTFE, perfluoroelastomer, tungsten carbide with nickel binder
Weight	
3KS Wall fluid panel.....	32.6 lb (14.8 kg)
Power/Barrier Assy .....	15.2 lb (6.9 kg)

\*Ratio ranges are dependent on flow rate, dose size and meter resolution

## ProMix 3KS Accessories

Cables	
123277	6 ft Yellow Color Change/Booth Control
123280	50 ft Yellow Color Change/Booth Control
123273	10 ft Green CAN Cable
123274	25 ft Green CAN Cable
123271	50 ft Red Power Cable
123272	100 ft Red Power Cable

### Miscellaneous Kits

16A732	3K Floor Stand Extension Extends 15V950 2KS floor stand for 3KS use
--------	--



# ProMix 2KS

## Technical Specifications

Maximum working air pressure	100 psig (7 bar)
Air supply	.75 to 100 psig (5 to 7 bar)
Air filtration	
Air logic (Graco supplied)	5 micron
Air purge (user supplied)	30 micron clean/dry
Air for atomizing (user supplied)	minimum of 30 micron clean/dry
Mix ratio range	
Sequential dosing	0.1:1 to 50:1
Dynamic dosing	0.1:1 to 30:1
Ratio accuracy	up to $\pm 1\%$ minimum (user selectable)
Fluids handled	one or two component: solvent and waterborne paints; polyurethanes; epoxies; acid catalyzed varnishes; moisture sensitive isocyanates
Fluid filtration	100 mesh min
Flow meters:	

METER	TYPE	MAX PRESSURE	FLOW RANGE	VISCOSITY
G250	Spur Gear	250 psi (17.2 bar)	75-3800 cc/min	20-3000 cps
G250HR	Spur Gear	250 psi (17.2 bar)	38-1900 cc/min	20-3000 cps
G3000	Spur Gear	4000 psi (275 bar)	75-3800 cc/min	20-3000 cps
G3000HR	Spur Gear	4000 psi (275 bar)	38-1900 cc/min	20-3000 cps
HG6000	Helical Gear	6000 psi (413 bar)	50-7500 cc/min	30-100,000 cps
1/4" Coriolis	Single Tube	2300 psi (158 bar)	20-3800 cc/min*	0.1-3000 cps
3/8" Coriolis	Single Tube	2300 psi (158 bar)	50-3800 cc/min*	0.1-3000 cps
S3000 (Solvent Meter)	Spur Gear	3000 psi (206 bar)	50-1600 cc/min	0.5-1000 cps**

\*Ratio and K-factor dependent

\*\*No filled materials

Component working pressure	
Wall fluid panel (no meters)	4000 psig (275 bar)
RoboMix fluid panel (G250 meters)	250 psig (17.2 bar)
Flow control regulator	200 psig (13 bar)
Low pressure color change valves	300 psig (20.6 bar)
High pressure color change valves	3000 psig (206.7 bar)
External power supply requirements	85-250 Vac, 50/60 Hz, 2 amps maximum draw, 15 amp maximum circuit breaker required, 8 to 14 AWG power supply wire gauge
Operating temperature range	41 to 122°F (5 to 50°C)
Noise level	
Sound pressure level	below 70 dBA
Sound power level	below 85 dBA
Wetted parts	303 SST, 17-4 SST, PTFE, perfluoroelastomer, tungsten carbide with nickle binder
Weight	
EasyKey display	21.75 lb (9.8 kg)
Remote operator station	0.95 lb (0.43 kg)
Wall fluid panel (no meters)	50 lb (22.7 kg)
RoboMix fluid panel (G250 meters included)	31.6 lb (14.3 kg)
Flow control regulator	4 lb (1.8 kg)
Approved for hazardous locations	US and Canada - class 1 Div 1 Group D T3 Europe - Zone 0 Ex ia IIA T3/ATEX II2G T3
Environmental condition rating	indoor use, pollution degree (2), installation category II

# ProMix 2KS

## Ordering Information

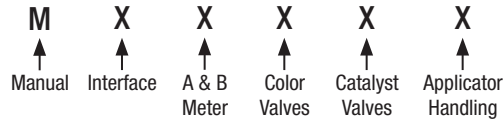

### Manual Wall Panel

	Interface	A & B Meter	Color Valves*	Catalyst Valves	Applicator Handling
M	D = EasyKey with LCD Display	0 = No Meter 1 = G3000 A & B 2 = G3000HR A & B 3 = 1/4" Coriolis A & G3000 B 4 = G3000 A & 1/4" Coriolis B 5 = 1/4" Coriolis A & G3000HR B 6 = G3000HR A & 1/4" Coriolis B 7 = 1/4" Coriolis A & 1/4" Coriolis B	0 = No Valves (Single Color) 1 = 2 Colors LP 2 = 4 Colors LP 3 = 7 Colors LP 4 = 12 Colors LP 5 = 2 Colors HP 6 = 4 Colors HP	0 = No Valves (Single Catalyst) 1 = 2 Catalysts LP 2 = 4 Catalysts LP 3 = 2 Catalysts HP	1 = 1 AFS 2 = 2 AFS 3 = 1 AFS with 1 GFB 4 = 2 AFS with 2 GFB

\*Order additional low pressure valves or other high pressure valve configurations as kits (see accessories).  
Manual systems only include dump valves when color *and* catalyst change are selected.

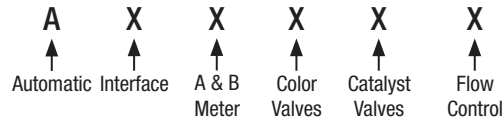

### Automatic Wall Panel

	Interface	A & B Meter	Color Valves*	Catalyst Valves	Flow Control**
A	D = EasyKey with LCD Display	0 = No Meter 1 = G3000 A & B 2 = G3000HR A & B 3 = 1/4" Coriolis A & G3000 B 4 = G3000 A & 1/4" Coriolis B 5 = 1/4" Coriolis A & G3000HR B 6 = G3000HR A & 1/4" Coriolis B 7 = 1/4" Coriolis A & 1/4" Coriolis B	0 = No Valves (Single Color) 1 = 2 Colors LP 2 = 4 Colors LP 3 = 7 Colors LP 4 = 12 Colors LP	0 = No Valves (Single Catalyst) 1 = 2 Catalysts LP 2 = 4 Catalysts LP	N = No*** Y = Yes

\*Order additional low pressure valves or other high pressure valve configurations as kits (see accessories).

\*\*Automatic systems with flow control include the integrated fluid regulator module.

\*\*\*If an external regulator module is desired, order N = No for flow control and order control module, cable and fluid regulator separately.

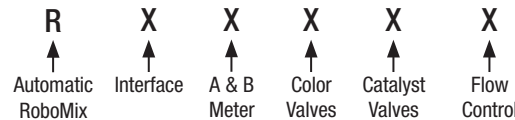

### Automatic RoboMix Panel

	Interface	A & B Meter	Color Valves*	Catalyst Valves	Flow Control**
R	D = EasyKey with LCD Display	0 = No Meter 1 = G250 A & B 2 = G250HR A & B	0 = No Valves (Single Color) 1 = 2 Colors LP 2 = 4 Colors LP 3 = 7 Colors LP 4 = 12 Colors LP	0 = No Valves (Single Catalyst) 1 = 2 Catalysts LP 2 = 4 Catalysts LP	N = No*** Y = Yes

\*Order additional low pressure valves as kits (see accessories).

\*\*Automatic systems with flow control include the integrated fluid regulator module.

\*\*\*If an external regulator module is desired, order N = No for flow control and order control module, cable and fluid regulator separately.

LP = low pressure; HP = high pressure; AFS = air flow switch; GFB = gun flush box

# ProMix 2KS

## Accessories

### Meter Kits

Contains one flow meter, cable and hardware

15V804	G3000 Flow Meter
15V827	G3000HR Flow Meter
15V820	HG6000 Flow Meter
24M261	1/4" Coriolis Flow Meter
258151	3/8" Coriolis Flow Meter
16D329	S3000 (Solvent) Flow Meter

### Low Pressure Color Change Kits

Contains color valves and solenoid control module. Order dump valves separately.

256581	2 Color
256582	4 Color
256583	7 Color
256584	12 Color
256585	2 Color and 2 Catalyst
256586	4 Color and 2 Catalyst
256587	4 Color and 4 Catalyst
256588	7 Color and 2 Catalyst
256589	7 Color and 4 Catalyst
256590	12 Color and 2 Catalyst
256591	12 Color and 4 Catalyst
256592	13-18 Colors
256593	13-24 Colors
256594	13-30 Colors
256595	0 Colors and 2 Catalysts

### High Pressure Color Change Kits

Contains color valves and solenoid control module. Order dump valves separately.

256596	2 Color
256597	4 Color
256598	7 Color
256599	12 Color
256600	2 Color and 2 Catalyst
256601	4 Color and 2 Catalyst
256602	4 Color and 4 Catalyst
256603	7 Color and 2 Catalyst
256604	7 Color and 4 Catalyst
256605	12 Color and 2 Catalyst
256606	12 Color and 4 Catalyst
256607	13-18 Colors
256608	13-24 Colors
256609	13-30 Colors
256610	0 Colors and 2 Catalysts

### Valve Kits

Contains valve, solenoid and hardware

15V821	Wall Panel Dump Valve
15V354	Wall Panel 3rd Flush Valve
15V822	RoboMix Panel Dump Valve
15V202	RoboMix Panel 3rd Flush Valve
15V077	Stainless Steel Needle High pressure valve
15V737	Lubrication Cup High and low pressure valve - supplies lubrication to the valve needle and seal
15U932	Carbide Seat High pressure valve

### Dosing Kits

Contains fluid manifold hardware

15V034	10 cc Sequential Dosing
15V033	25 cc Sequential Dosing
15V021	50 cc Sequential Dosing
24B618	100 cc Sequential Dosing
15U955	0 cc Dynamic Dosing

### RoboMix Panel Kits

Used to interface up to two air flow switches and two gun flush boxes to a RoboMix Panel. Order air flow switch or gun flush box kits separately.

15V267	RoboMix Panel Ratio Check Kit
15V534	Manual Gun Interface Kit

### Communication Kits

15V825 Discrete I/O Integration Board Kit  
Contains inputs and outputs for controlling automatic integration and special output functionality. Included in automatic kits.

15W023 Communication + I/O Harness Kit  
Cable and terminal strip for alarm monitoring, remote stop input and flow control inputs. Included in automatic kits.

15V331 Ethernet IP Gateway Assembly  
15V963 DeviceNet Gateway Assembly  
15V964 Profibus Gateway Assembly  
Network communication assembly for automatic integration. Contains gateway module, power supply, and enclosure.

15V337 Advanced Web Interface with Eight Port Hub  
Contains web server module, power supply, eight port hub and enclosure

15V336 Eight Port Ethernet Hub  
Contains eight port hub, power supply and enclosure

121998	25 ft CAT V Cable
121999	50 ft CAT V Cable
15V842	100 ft CAT V Cable
15V843	200 ft CAT V Cable

### Cables

15V213	100 ft Power Cable
15G710	100 ft Fiber Optic Cable
15U977	40 ft Flow Control Extension Cable
15U532	3 ft CAN Cable
15V205	6 ft CAN Cable
15V206	10 ft CAN Cable
15V207	15 ft CAN Cable
15V208	25 ft CAN Cable
15U533	50 ft CAN Cable

### Miscellaneous Kits

15V826 Gun Flush Box Kit  
Contains guns flush box and control hardware

570123 Gun Flush Box Wall Mount Kit

15V823 Gun Air Shutoff Kit  
Used to automatically shut off gun atomizing air during flush and fill sequences without a gun flush box

15T632 Air Flow Switch Kit

15V350 Remote Operator Station Kit

15V256 Manual to Automatic Conversion Kit

15X247 Auto Dump Kit  
Used to incorporate an auto dump feature without a gun flush box. Contains a dump valve, solenoid and hardware

949122 Clear Plastic Static Mixer

15V536 Solvent Flow Switch  
Used to detect solvent flow during flush sequences

15W034 Alarm Light for Manual Systems

122193 Alarm Light for Automatic Systems

15V950 Floor Stand

Contains provisions for mounting a wall fluid panel, EasyKey display and color change module.

197902 EasyKey Paint Shields  
Includes 10 disposable clear plastic shields to cover the EasyKey display and shield it from paint overspray

15M483 Remote Operator Station Paint Shields  
Includes 10 disposable clear plastic shields to cover the remote operator station display and shield it from paint overspray

15W600 Wall Panel Fluid Manifold Cover

### Gun Flush Box Gun Holders

198787	Graco Pro Xs2
198405	Graco Pro Xs3, Pro Xs4
196768	Graco PRO 3500, 3500hc, 4500
15T646	Graco AirPro Air Spray
196769	Graco Delta Air Spray
196770	Graco Alpha
196771	Graco Alpha Plus, Alpha Plus RAC
15G093	Graco G15
15G346	Graco G40, G40 RAC
24N528	Graco Pro Xp60 and Pro Xp80
24N529	Graco Pro Xp40

### Flow Control Parts & Accessories

249849	Flow Control module, integrated fluid regulator
24H989	Flow Control module, external fluid regulator (fluid regulator not included)
15U977	Cable, flow control Required for 24H989. Included with integrated flow control (249849) when ordered with a ProMix 2KS system.



## ABOUT GRACO

### PROVEN QUALITY. LEADING TECHNOLOGY.

Founded in 1926, Graco is a world leader in fluid handling systems and components. Graco products move, measure, control, dispense and apply a wide range of fluids and viscous materials used in vehicle lubrication, commercial and industrial settings.

The company's success is based on its unwavering commitment to technical excellence, world-class manufacturing and unparalleled customer service. Working closely with qualified distributors, Graco offers systems, products and technology that set the quality standard in a wide range of fluid handling solutions. Graco provides equipment for spray finishing, protective coating, paint circulation, lubrication, and dispensing sealants and adhesives, along with power application equipment for the contractor industry. Graco's ongoing investment in fluid management and control will continue to provide innovative solutions to a diverse global market.

## GRACO LOCATIONS

### MAILING ADDRESS

P.O. Box 1441  
Minneapolis, MN 55440-1441  
Tel: 612-623-6000  
Fax: 612-623-6777

### AMERICAS

#### MINNESOTA

Worldwide Headquarters  
Graco Inc.  
88-11th Avenue N.E.  
Minneapolis, MN 55413

### EUROPE

#### BELGIUM

European Headquarters  
Graco N.V.  
Industrieterrein-Oude Bunders  
Slakweidestraat 31  
3630 Maasmechelen,  
Belgium  
Tel: 32 89 770 700  
Fax: 32 89 770 777

### ASIA PACIFIC

#### AUSTRALIA

Graco Australia Pty Ltd.  
Suite 17, 2 Enterprise Drive  
Bundoora, Victoria 3083  
Australia  
Tel: 61 3 9467 8558  
Fax: 61 3 9467 8559

#### CHINA

Graco Hong Kong Ltd.  
Shanghai Representative Office  
Room 118 1st Floor  
No.2 Xin Yuan Building  
No.509 Cao Bao Road  
Shanghai, 200233  
The People's Republic of China  
Tel: 86 21 649 50088  
Fax: 86 21 649 50077

#### INDIA

Graco India Pvt Ltd  
Plot No 295, Udyog Vihar Phase-IV  
Gurugram - 122015 (Haryana)  
India  
Tel: 91 124 661 0200  
Fax: 91 124 661 0201

#### JAPAN

Graco K.K.  
1-27-12 Hayabuchi  
Tsuzuki-ku  
Yokohama City, Japan 2240025  
Tel: 81 45 593 7300  
Fax: 81 45 593 7301

#### KOREA

Graco Korea Inc.  
38, Samsung 1-ro 1-gil  
Hwaseong-si, Gyeonggi-do,  
18449  
Republic of Korea  
Tel: 82 31 8015 0961  
Fax: 82 31 613 9801

## SALES/ DISTRIBUTION/ SERVICE

Call today for product information or to request a demonstration.

**877-84GRACO (1-877-844-7226)** or visit us at [www.graco.com](http://www.graco.com).

Graco Inc. is registered to I.S. EN ISO 9001

North America  
Customer Service  
800-328-0211  
Fax 877-340-6427