



# Barrington Mantel

## Installation Instructions

### Models:

**BWC300-DW, BWC300-U,  
BWC400-DW, BWC400-U,  
BWC500-DW, BWC500-U**

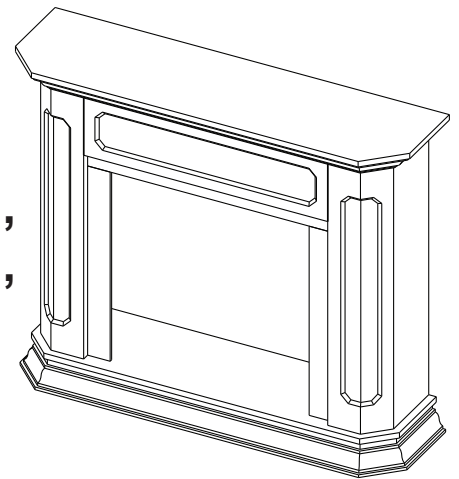

### Hardware List



#10 2 1/2" Wood  
Screws (2)



#10 1 1/4" Wood  
Screws (26)

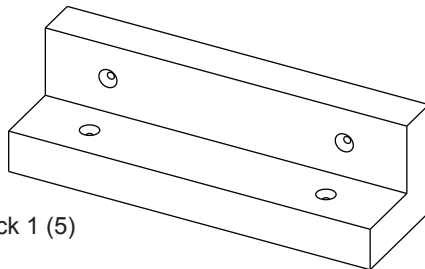

Joining Block 1 (5)

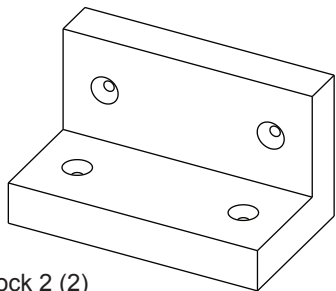

Joining Block 2 (2)

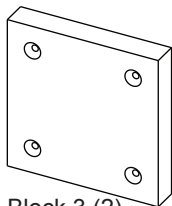

Joining Block 3 (2)

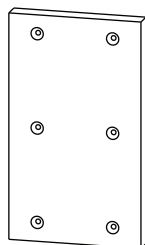

Joining Block 4

### Parts List

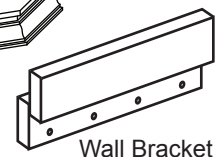
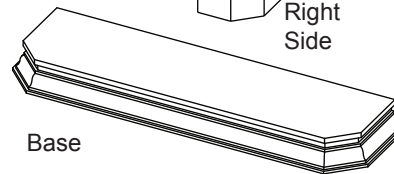
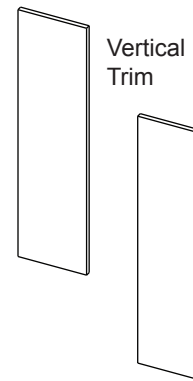
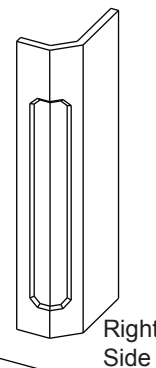
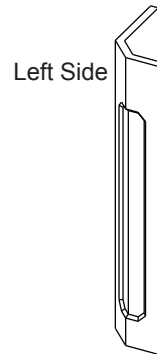
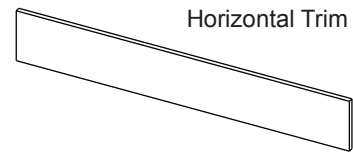
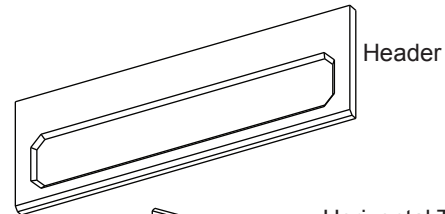
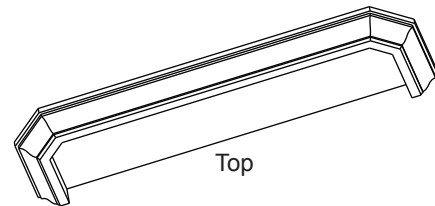

1. Place base near final position. Make sure you have access to all four (4) sides.
2. Place sides in the approximate location on base. Align back edge of side with back of base. Secure joining block #1 to bottom of side using two (2) 1/4" screws. Be sure joining block is flush with bottom of side piece. (Do not attach to base at this time)
3. With the aid of an assistant, and using two (2) joining block #4 and (12) 1/4" screws, secure header to the sides. Carefully match the moulding.
4. Adjust cabinet assembly so it is centered from side to side and the back of the sides are aligned with the back of the base.
5. Temporarily place top on side/header assembly. Adjust sides parallel to the base and top side. Secure the sides to the base using two (2) 1/4" screws in each of the joining blocks.

**NOTE: Refer to fireplace Homeowner's Manual for clearances and installation instructions.**

**If using fireplace trims or facings, check fireplace Homeowner's Manual for installation.**

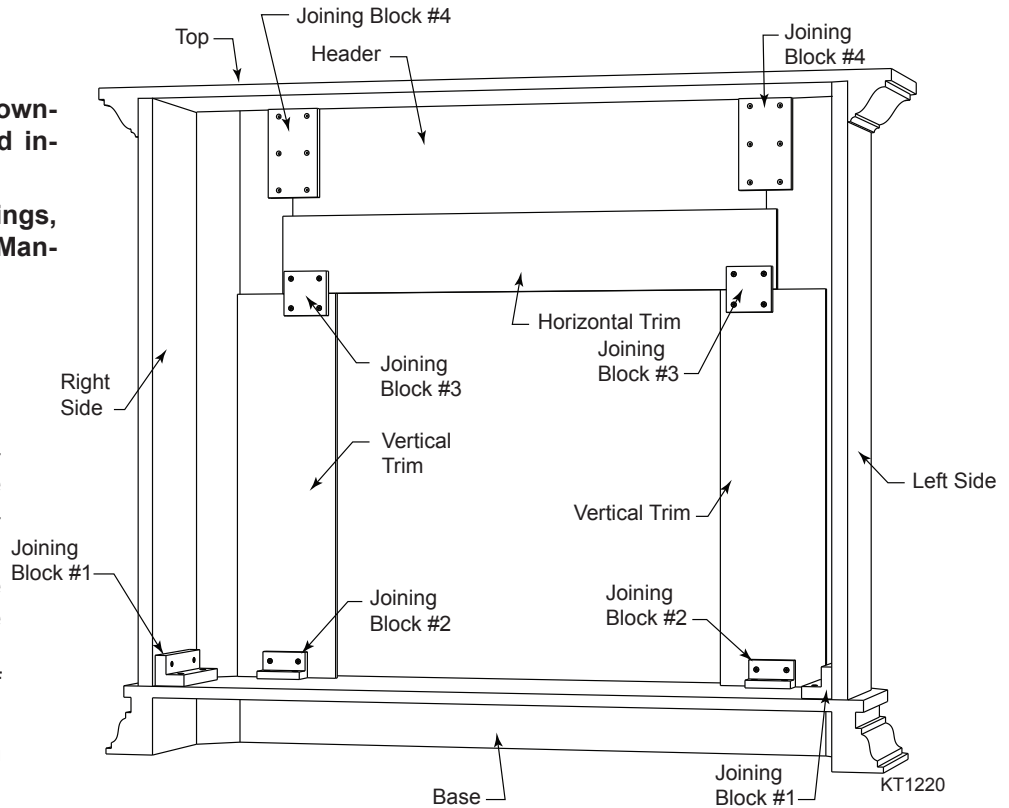

6. Once the mantel is assembled, temporarily place the fireplace into the mantel in order to locate the trim pieces.
7. Center the fireplace in the opening with the inside of the fireplace trim or facing even with the inside of the front of the mantel.
8. Attach the horizontal trim piece to the mantel header. Make sure the horizontal trim is centered and there is an approximate 1/4" gap between the bottom of the horizontal trim and the top of the fireplace. Secure with two (2) screws; one on each end of the trim piece in the pre-drilled holes.
9. Place the vertical trim pieces so the edge is about 1/4" from the fireplace body. Make sure the joint between the trim pieces is satisfactory. Secure through joining block #3 into horizontal trim using two (2) screws. Attach joining block #2 to the bottom of the vertical trim. Repeat for other side.
10. Remove fireplace and move mantel to its final position. Cut wall base moulding as necessary to provide adequate fit against wall.
11. Locate (anti-tip) bracket on wall so the cleat on the underside of the mantel top is captured in the wall bracket and the wall bracket is screwed into a stud.

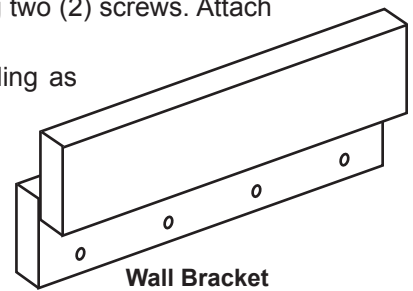

**MHSC**

149 Cleveland Drive • Paris, Kentucky 40361  
www.mhsc.com