



Please consult the manufacturer's installation manual for all details and requirements before making a final design layout decision.

Courtyard 36

Outdoor Gas Fireplace

MODEL	FRONT WIDTH		BACK WIDTH		HEIGHT		DEPTH		VIEWING AREA
	Actual	Framing	Actual	Framing	Actual	Framing	Actual	Framing	
ODCOUG-36	41-3/4" (1060mm)	43-1/2" (1105mm)	31-1/2" (800mm)	43-1/2" (1105mm)	44" (1118mm)	44-1/8" (1121mm)	18" (457mm)	18-1/8" (459mm)	36" x 30-3/4" (914mm x 781mm)

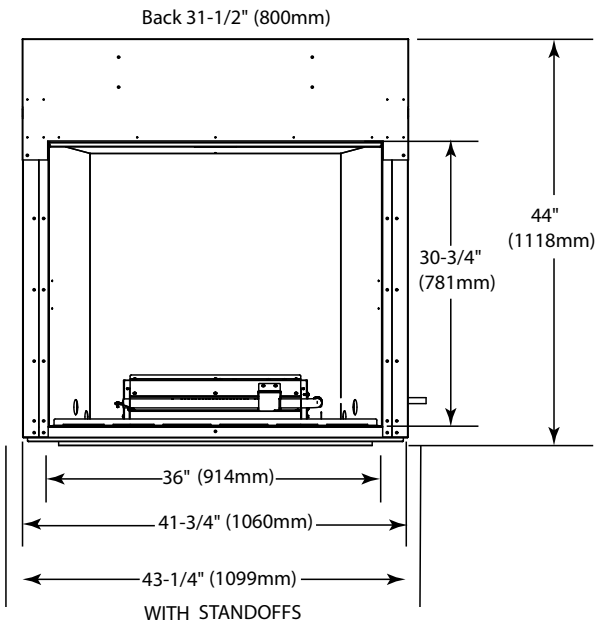

FRONT VIEW

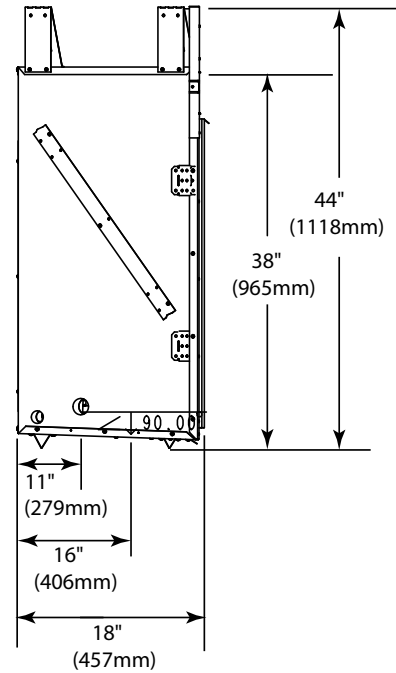

SIDE VIEW

APPLIANCE LOCATIONS

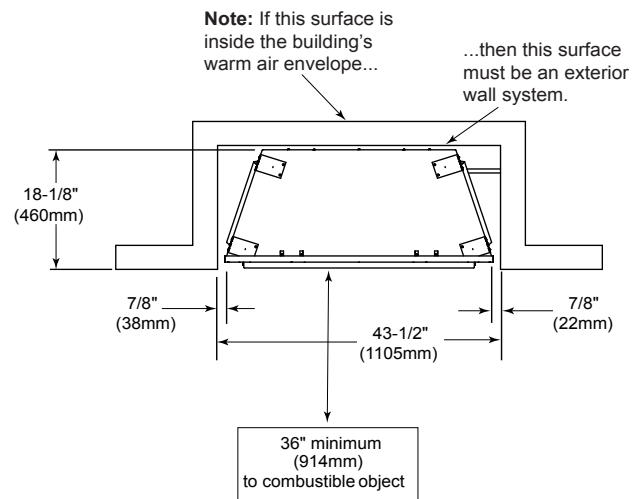
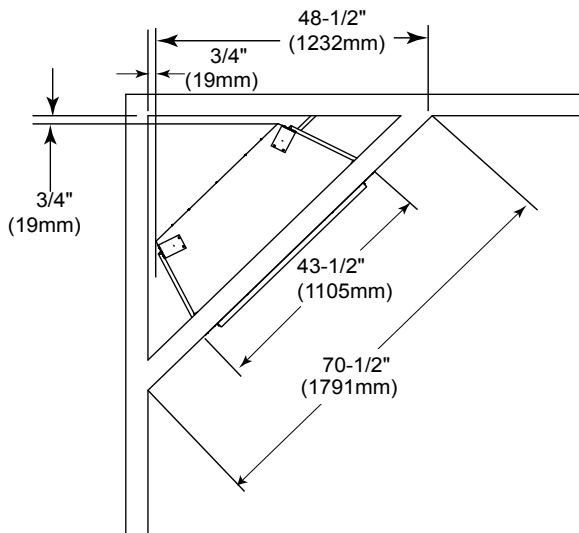

FRAMING DIMENSIONS

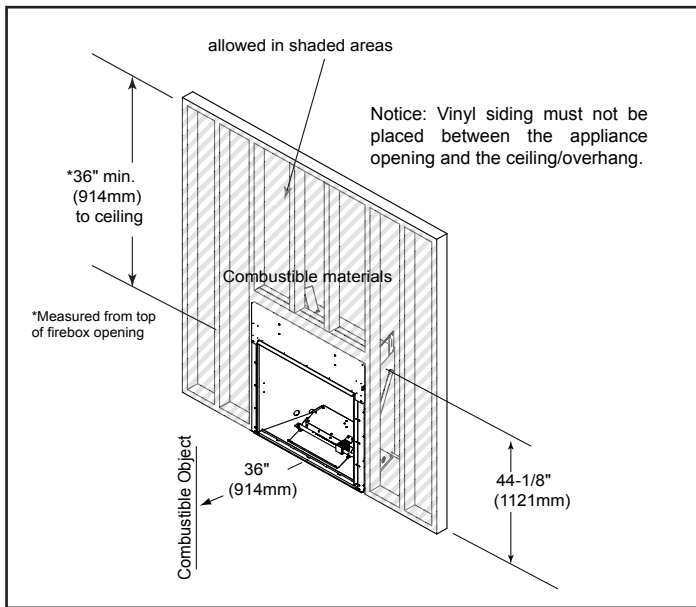

CLEARANCES TO COMBUSTIBLES

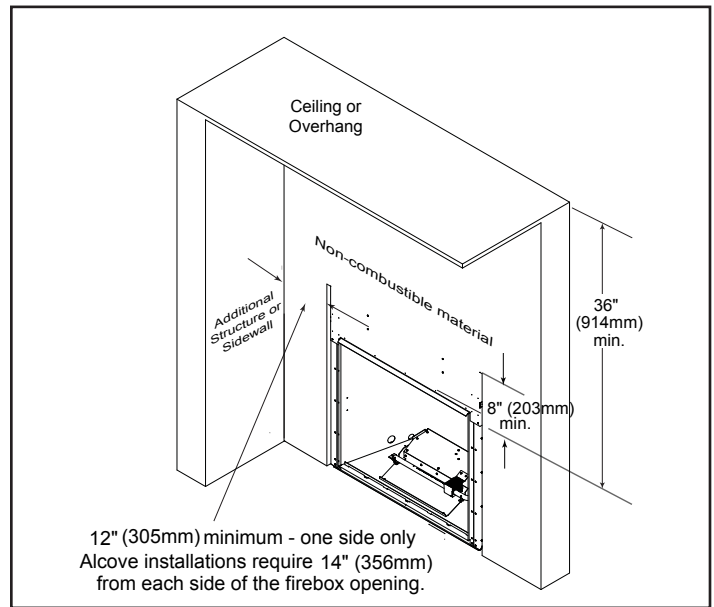

COMBUSTIBLE MANTEL PROJECTIONS

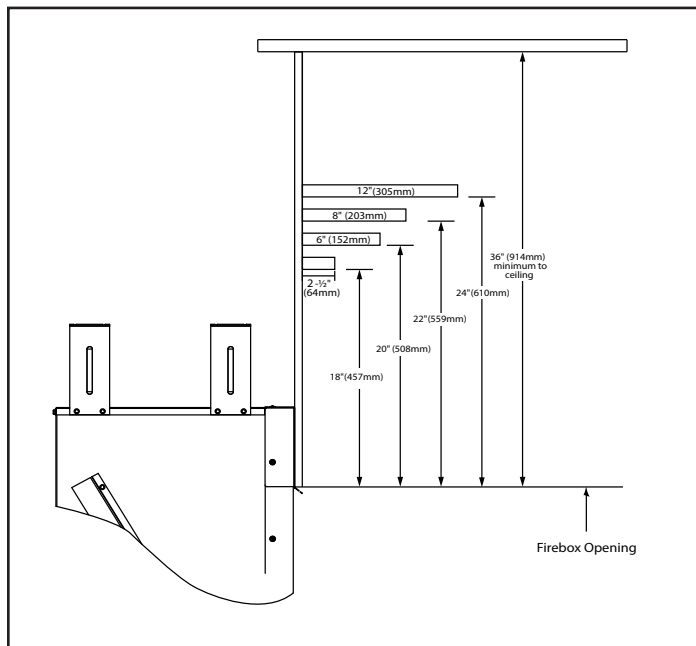

BUILT-IN INSTALLATION

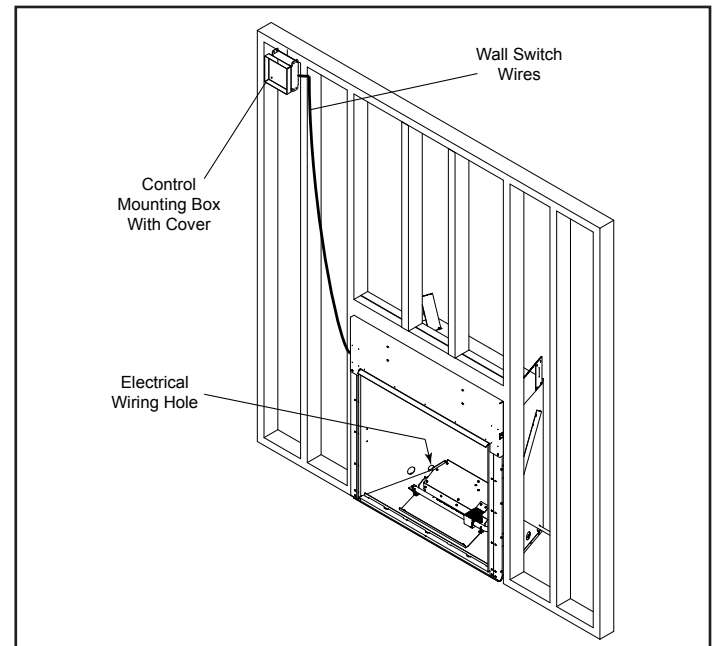

MOISTURE RESISTANCE

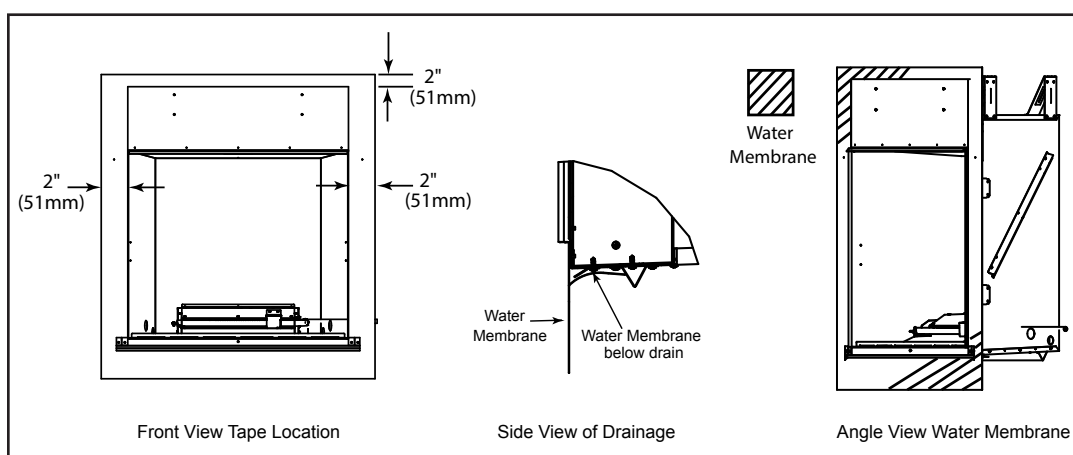

PRODUCT LISTING CODES	
US	ANSI Z21.97-2010
CAN	CR97-003

Additional information can be found online at www.fireplaces.com.

Product information provided is not complete and is subject to change without notice. Product installation must adhere strictly to instructions accompanying product to avoid risk of fire and potential injury.