



Jungčių katalogas
2023

01 Srieginés jungtys

01 Srieginės jungtys



Movos 20 bar

D1	D3	L	AISI 316
1/8"	14,0	20,0	●
1/4"	18,5	25,0	●
3/8"	21,5	26,0	●
1/2"	26,5	34,0	●
3/4"	32,0	36,0	●
1"	39,5	43,0	●
1 1/4"	48,5	48,0	●
1 1/2"	54,5	48,0	●
2"	66,5	56,0	●
2 1/2"	82,0	65,0	●
3"	95,0	71,0	●
4"	122,0	83,0	●



Movos 40-100 bar

D1	D3	L	EN 1.4404
1/8"	14,0	17,0	●
1/4"	18,5	25,0	●
3/8"	21,5	26,0	●
1/2"	26,5	34,0	●
3/4"	32,0	36,0	●
1"	39,5	43,0	●
1 1/4"	48,5	48,0	●
1 1/2"	54,5	48,0	●
2"	66,5	56,0	●
2 1/2"	82,0	65,0	○
3"	95,0	71,0	○
4"	122,0	85,0	○



Pusinės movos 20 bar

D1	D3	L	AISI 316
1/8"	14,0	11,0	●
1/4"	18,5	13,0	●
3/8"	21,5	12,0	●
1/2"	26,5	15,0	●
3/4"	32,0	17,0	●
1"	39,5	19,0	●
1 1/4"	48,5	22,0	●
1 1/2"	54,5	22,0	●
2"	66,5	26,0	●
2 1/2"	82,0	30,0	●
3"	95,0	33,0	●
4"	122,0	40,0	●



Pusinės movos 40-100 bar

D1	D3	L	EN 1.4404
1/8"	14,0	10,0	○
1/4"	18,5	10,0	●
3/8"	21,5	12,0	●
1/2"	26,5	15,0	●
3/4"	32,5	17,0	●
1"	40,0	19,5	●
1 1/4"	48,5	22,0	●
1 1/2"	54,5	22,0	●
2"	66,5	26,0	●
2 1/2"	82,0	30,5	○
3"	95,0	34,0	○

● = sandėliuojama ○ = užsakoma pardavimai@busgeriau.lt +37066276762

01 Srieginės jungtys

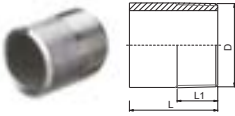

Privir. nipelis

Busgeriau nr. 3060

20 bar

D	L1	L	AISI 316
1/8"	10,0	30,0	●
1/4"	12,0	30,0 100,0	●
3/8"	12,0	30,0 100,0	●
1/2"	17,0	35,0 100,0	●
3/4"	19,0	40,0 100,0	●
1"	19,0	40,0 100,0	●
1 1/4"	22,0	50,0 100,0	●
1 1/2"	22,0	50,0 100,0	●
2"	25,0	50,0 100,0	●
2 1/2"	25,0	60,0 100,0	●
3"	30,0	70,0	●
4"	35,0	80,0	●



Privir. nipelis

40-100 bar

D	L1	L	EN 1.4408
1/8"	6,0	30,0	●
1/4"	9,0	30,0 100,0	●
3/8"	9,0	30,0 100,0	●
1/2"	12,0	35,0 100,0	●
3/4"	13,0	40,0 100,0	●
1"	15,0	40,0 100,0	●
1 1/4"	17,0	50,0	●
1 1/2"	17,0	50,0	●
2"	22,0	50,0	●
2 1/2"	24,0	60,0	○
3"	27,0	70,0	○
4"	33,0	80,0	○

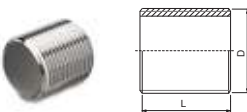

Nipelis 20 bar

D	L	AISI 316
1/8"	16,0	●
1/4"	18,0	●
3/8"	22,0	●
1/2"	25,0	●
3/4"	30,0	●
1"	35,0	●
1 1/4"	38,0	●
1 1/2"	38,0	●
2"	45,0	●
2 1/2"	55,0	●
3"	60,0	●
4"	70,0	●

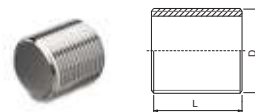

Nipelis 40-100 bar

D	L	EN 1.4404
1/8"	16,0	○
1/4"	18,0	○
3/8"	22,0	○
1/2"	25,0	○
3/4"	30,0	○
1"	35,0	○
1 1/4"	38,0	○
1 1/2"	38,0	○
2"	45,0	○
2 1/2"	55,0	○
3"	60,0	○

● = sandėliuojama ○ = užsakoma pardavimai@busgeriau.lt +37066276762

01 Srieginės jungtys

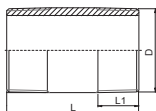

Vamzdis su sriegiais 20 bar, AISI 316L

D	L1	L															
		30	40	50	60	70	75	80	90	100	120	150	180	200	250	300	
1/8"	10,0	●	●	○	○	○	○	○	○	○	○	○	○	○	○	○	○
1/4"	12,0	●	●	●	●	●	○	●	●	●	●	●	●	●	●	●	●
3/8"	12,0	●	●	●	●	●	○	●	●	●	●	●	●	●	●	●	●
1/2"	17,0	○	●	●	●	●	○	●	●	●	●	●	●	●	●	●	●
3/4"	19,0	○	●	●	●	●	○	●	●	●	●	●	●	●	●	●	●
1"	19,0	○	●	●	●	●	○	●	○	●	●	●	●	●	●	●	●
1 1/4"	22,0	○	○	●	●	○	○	●	○	●	●	●	●	●	●	●	●
1 1/2"	22,0	○	○	●	●	○	○	●	○	●	●	●	●	●	●	●	●
2"	26,0	○	○	●	●	○	○	●	○	●	●	●	●	●	●	●	●
2 1/2"	26,0	○	○	○	○	○	○	○	○	●	○	○	○	○	○	○	○
3"	30,0	○	○	○	○	○	○	○	○	○	●	○	○	○	○	○	○
4"	35,0	○	○	○	○	○	○	○	○	○	○	●	○	○	○	○	○

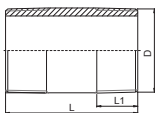

Vamzdis su sriegiais 40-100 bar

D	L1	L*	EN 1.4404
1/8"	6,0	40,0	●
1/4"	9,0	40,0	●
3/8"	9,0	40,0	●
1/2"	12,0	60,0	●
3/4"	13,0	60,0	●
1"	15,0	60,0	●
1 1/4"	17,0	80,0	●
1 1/2"	17,0	80,0	●
2"	22,0	100,0	●
2 1/2"	24,0	100,0	○
3"	27,0	120,0	○
4"	33,0	150,0	○



Vamzdis su sriegiais 20 bar

D	L	AISI 316
1/4"	25,0	●
3/8"	25,0	●
1/2"	30,0	●
3/4"	30,0	●
1"	30,0	●
1 1/4"	40,0	●
1 1/2"	40,0	●
2"	40,0	●

*kiti ilgiai = greitas pristatymas

● = sandėliuojama ○ = užsakoma

pardavimai@busgeriau.lt +37066276762

01 Srieginės jungtys

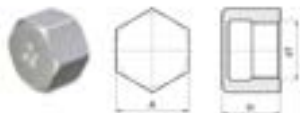

Dangtelis vidinis 10 bar

d1	A	H	AISI 316
1/8"	13,5	13,5	●
1/4"	16,8	18,5	●
3/8"	20,2	19,5	●
1/2"	24,6	21,1	●
3/4"	30,1	21,7	●
1"	37,5	24,8	●
1 1/4"	46,7	26,5	●
1 1/2"	53,0	30,0	●
2"	65,7	34,2	●
2 1/2"	80,5	38,7	●
3"	96,0	42,5	●
4"	123,3	48,4	●

Dangtelis vidinis 40-100 bar

d1	A	H	EN 1.4404
1/8"	14,0	13,0	○
1/4"	19,0	17,0	●
3/8"	22,0	18,0	●
1/2"	27,0	22,0	●
3/4"	32,0	24,0	●
1"	41,0	28,0	●
1 1/4"	50,0	30,0	●
1 1/2"	55,0	31,0	●
2"	70,0	35,0	●
2 1/2"	85,0	40,0	○
3"	95,0	45,0	○
4"	126,0	45,0	○

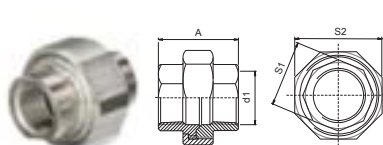
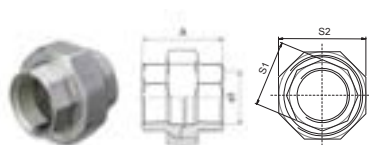

Jungtis V/V 10 bar

3015 – su konusu

3016 – su plokštuma + PTFE

d1	A	S1	S2	AISI 316
1/8"	36,3	13,3	24,1	●
1/4"	36,3	16,8	27,6	●
3/8"	37,2	20,2	34,0	●
1/2"	39,1	24,5	39,5	●
3/4"	45,4	29,7	46,7	●
1"	49,0	36,5	54,0	●
1 1/4"	51,1	46,2	63,9	●
1 1/2"	54,2	52,3	73,5	●
2"	58,8	64,6	86,9	●
2 1/2"	74,5	79,2	102,5	●
3"	89,5	94,9	121,9	●
4"	98,6	120,3	151,3	●

Jungtis V/V 40-100 bar

3017 – su konusu

3018 – su plokštuma + PTFE

d1	A	S1	S2	EN 1.4404
1/8"	32,0	15,0	24,0	○
1/4"	38,0	20,5	30,0	●
3/8"	41,0	24,0	38,0	●
1/2"	46,0	29,0	43,0	●
3/4"	50,0	35,0	50,0	●
1"	56,0	44,0	60,0	●
1 1/4"	62,0	52,0	67,0	●
1 1/2"	64,0	58,0	73,0	●
2"	67,0	71,5	87,0	●
2 1/2"	70,0	88,0	110,0	○
3"	75,0	102,0	128,0	○

● = sandėliuojama ○ = užsakoma pardavimai@busgeriau.lt +37066276762

01 Srieginės jungtys

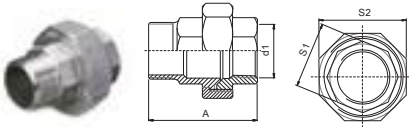

Jungtis V/I 10 bar

3020 – su konusu

3021 – su plokštuma + PTFE

d1	A	S1	S2	AISI 316
1/8"	42,5	13,3	24,1	●
1/4"	46,5	16,8	27,6	●
3/8"	47,2	20,2	34,0	●
1/2"	53,5	24,5	39,5	●
3/4"	57,0	29,7	46,7	●
1"	66,1	36,5	54,0	●
1 1/4"	67,8	46,2	63,9	●
1 1/2"	75,2	52,3	73,5	●
2"	84,4	64,6	86,9	●
2 1/2"	99,0	79,2	102,5	●
3"	118,0	94,9	121,9	●
4"	130,3	120,3	151,3	●

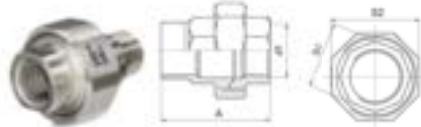

Jungtis V/I 40-100 bar

3022 – su konusu

3023 – su plokštuma + PTFE

d1	A	S1	S2	EN 1.4404
1/8"	40,5	15,0	24,0	○
1/4"	47,0	20,5	30,0	●
3/8"	53,0	24,0	38,0	●
1/2"	62,0	29,0	43,0	●
3/4"	66,0	35,0	50,0	●
1"	74,0	44,0	60,0	●
1 1/4"	81,0	52,0	67,0	●
1 1/2"	84,0	58,0	73,0	●
2"	87,0	71,5	87,0	●
2 1/2"	97,0	88,0	110,0	○
3"	109,0	102,0	125,0	○

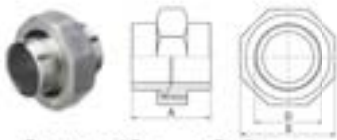

Jungtis, virinama

3025 su konusu

3026 su plokštuma + PTFE

10 bar

d1	A	D	S	AISI 316
1/8"	-	-	-	○
1/4"	31,0	13,8	28,0	○
3/8"	38,0	17,3	34,0	●
1/2"	40,0	21,6	39,5	●
3/4"	47,1	27,1	47,0	●
1"	49,6	34,0	54,0	●
1 1/4"	54,3	42,7	64,0	●
1 1/2"	57,2	48,6	73,5	●
2"	60,0	60,5	87,0	●
2 1/2"	70,4	76,3	103,0	●
3"	81,0	89,1	122,0	○
4"	92,3	114,3	151,5	○



Jungtis, virinama

3027 su konusu

3028 su plokštuma + PTFE

40-100 bar

d1	A	D	S	EN 1.4404
1/8"	-	-	-	○
1/4"	-	-	-	○
3/8"	-	-	-	○
1/2"	40,0	21,3	38,0	●
3/4"	44,0	26,9	43,0	●
1"	53,0	33,7	60,0	●
1 1/4"	57,0	42,4	68,0	●
1 1/2"	63,0	48,3	74,0	●
2"	74,0	60,3	88,0	●
2 1/2"	80,0	77,0	110,0	○
3"	83,0	89,0	128,0	○

● = sandėliuojama

○ = užsakoma

pardavimai@busgeriau.lt +37066276762

01 Srieginės jungtys



Alkūnė V/V 10 bar

d1	d2	E	AISI 316
1/8"	14,8	17,0	●
1/4"	18,3	19,0	●
3/8"	21,7	23,0	●
1/2"	26,6	27,0	●
3/4"	32,1	32,0	●
1"	39,5	38,0	●
1 1/4"	49,2	45,0	●
1 1/2"	54,3	48,0	●
2"	68,2	57,0	●
2 1/2"	83,5	69,0	●
3"	99,0	78,0	●
4"	125,0	96,0	●



Alkūnė V/V 40-100 bar

d1	D	H	EN 1.4408
1/8"	14,0	19,0	○
1/4"	17,5	21,0	●
3/8"	21,6	25,0	●
1/2"	27,0	28,0	●
3/4"	33,3	34,0	●
1"	40,0	38,0	●
1 1/4"	51,0	45,0	●
1 1/2"	57,6	50,0	●
2"	68,0	58,0	●
2 1/2"	84,0	75,0	○
3"	98,0	85,0	○

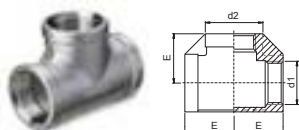

Trišakis 10 bar

d1	d2	E	AISI 316
1/8"	14,8	17,0	●
1/4"	18,3	19,0	●
3/8"	21,7	23,0	●
1/2"	26,6	27,0	●
3/4"	32,1	32,0	●
1"	39,5	38,0	●
1 1/4"	49,2	45,0	●
1 1/2"	54,3	48,0	●
2"	68,2	57,0	●
2 1/2"	83,5	69,0	●
3"	99,0	78,0	●
4"	125,0	96,0	●

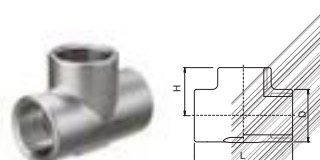

Trišakis 40-100 bar

d1	D	H	EN 1.4408
1/8"	14,0	17,0	○
1/4"	17,5	19,0	●
3/8"	21,6	23,0	●
1/2"	27,0	27,0	●
3/4"	33,0	32,0	●
1"	40,0	38,0	●
1 1/4"	51,0	45,0	●
1 1/2"	57,6	48,0	●
2"	67,8	57,0	●
2 1/2"	84,0	69,0	○
3"	98,0	78,0	○

● = sandėliuojama ○ = užsakoma pardavimai@busgeriau.lt +37066276762

01 Srieginės jungtys



Alkūnė V/I 10 bar



Alkūnė V/I 40-100 bar

d1	d2	E	E1	AISI 316
1/8"	14,8	17,0	26,0	●
1/4"	18,3	19,0	27,0	●
3/8"	21,7	23,0	29,0	●
1/2"	26,6	27,0	35,0	●
3/4"	32,1	32,0	40,0	●
1"	39,5	38,0	46,0	●
1 1/4"	49,2	45,0	54,0	●
1 1/2"	55,5	48,0	57,0	●
2"	68,2	57,0	70,0	●
2 1/2"	83,5	69,0	83,0	●
3"	99,0	78,0	94,0	●
4"	126,3	97,0	115,0	●

d1	d2	E	E1	EN 1.4408
1/8"	-	-	-	-
1/4"	17,5	19,0	27,0	●
3/8"	21,6	21,0	29,0	●
1/2"	27,0	25,0	35,0	●
3/4"	33,0	30,0	40,0	●
1"	40,0	37,0	46,0	●
1 1/4"	51,0	43,0	54,0	●
1 1/2"	57,6	49,0	57,0	●
2"	68,0	59,0	70,0	●

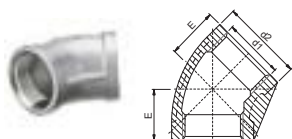

Alkūnė 45° 10 bar

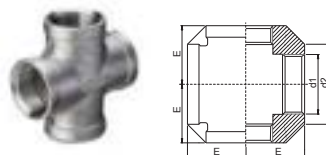

Keturšakis 10 bar

d1	d2	E	AISI 316
1/8"	14,8	16,0	○
1/4"	18,3	17,0	●
3/8"	21,7	19,0	●
1/2"	26,6	21,0	●
3/4"	32,1	25,0	●
1"	39,5	29,0	●
1 1/4"	49,2	33,0	●
1 1/2"	54,3	37,0	●
2"	68,2	42,0	●
2 1/2"	83,5	49,0	○
3"	99,0	54,0	○
4"	125,0	64,0	○

d1	d2	E	AISI 316
1/8"	14,8	17,0	○
1/4"	18,3	19,0	●
3/8"	21,7	23,0	●
1/2"	26,6	27,0	●
3/4"	32,5	32,0	●
1"	39,5	38,0	●
1 1/4"	49,2	45,0	●
1 1/2"	55,5	48,0	●
2"	68,2	57,0	●
2 1/2"	83,5	69,0	○
3"	99,0	78,0	○
4"	125,0	96,0	○

● = sandėliuojama ○ = užsakoma

pardavimai@busgeriau.lt +37066276762

01 Srieginės jungtys

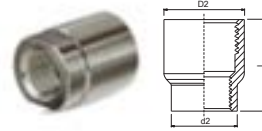
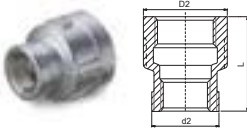

Mova, redukcinė 10 bar

Mova, redukcinė 40-100 bar

D x d	D2	d2	L	AISI 316
1/4" x 1/8"	18,3	14,8	25,0	●
3/8" x 1/8"	21,7	14,8	26,0	●
3/8" x 1/4"	21,7	18,3	26,0	●
1/2" x 1/8"	26,6	14,8	34,0	●
1/2" x 1/4"	26,6	18,3	34,0	●
1/2" x 3/8"	26,6	21,7	34,0	●
3/4" x 1/4"	32,1	18,3	36,0	●
3/4" x 3/8"	32,1	21,7	36,0	●
3/4" x 1/2"	32,1	26,6	36,0	●
1" x 1/4"	39,5	18,3	42,0	●
1" x 3/8"	39,5	21,7	42,0	●
1" x 1/2"	39,5	26,6	42,0	●
1" x 3/4"	39,5	32,1	42,0	●
1 1/4" x 1/2"	49,2	26,6	48,0	●
1 1/4" x 3/4"	49,2	32,1	48,0	●
1 1/4" x 1"	49,2	39,5	48,0	●
1 1/2" x 1/2"	55,5	26,6	52,0	●
1 1/2" x 3/4"	55,5	32,1	52,0	●
1 1/2" x 1"	55,5	39,5	52,0	●
1 1/2" x 1 1/4"	55,5	49,2	52,0	●
2" x 1/2"	68,2	26,6	58,0	●
2" x 3/4"	68,2	32,1	58,0	●
2" x 1"	68,2	39,5	58,0	●
2" x 1 1/4"	68,2	49,2	58,0	●
2" x 1 1/2"	68,2	55,5	58,0	●
2 1/2" x 1 1/2"	83,5	55,5	65,0	●
2 1/2" x 2"	83,5	68,2	65,0	●
3" x 2"	99,0	68,2	72,0	●
3" x 2 1/2"	99,0	83,5	72,0	●
4" x 3"	126,3	99,0	94,0	●

D x d	D2	d2	L	EN 1.4404
1/4" x 1/8"	18,8	14,0	27,0	●
3/8" x 1/4"	21,4	19,0	30,0	●
1/2" x 1/4"	27,5	19,0	36,0	●
1/2" x 3/8"	27,5	23,0	36,0	●
3/4" x 3/8"	32,5	23,0	39,0	●
3/4" x 1/2"	32,5	28,0	39,0	●
1" x 1/2"	39,5	28,0	45,0	●
1" x 3/4"	39,5	32,5	45,0	●
1 1/4" x 1/2"	49,5	28,0	52,0	○
1 1/4" x 3/4"	49,5	32,5	52,0	○
1 1/4" x 1"	49,5	39,5	52,0	●
1 1/2" x 3/4"	54,7	32,5	55,0	○
1 1/2" x 1"	54,7	39,5	55,0	●
1 1/2" x 1 1/4"	54,7	49,5	55,0	●
2" x 1"	69,5	39,5	65,0	●
2" x 1 1/4"	69,5	49,5	65,0	●
2" x 1 1/2"	69,5	55,5	65,0	●
2 1/2" x 2"	84,0	69,5	74,0	○
3" x 2"	99,5	69,5	78,0	○
3" x 2 1/2"	99,5	84,0	80,0	○



Alkūnė I/I 90° 20 bar

d1	D	L	AISI 316
1/8"	10,2	50,0	●
1/4"	13,5	60,0	●
3/8"	17,2	70,0	●
1/2"	21,3	80,0	●
3/4"	26,9	100,0	●
1"	33,7	120,0	●
1 1/4"	42,4	140,0	●
1 1/2"	48,3	160,0	●
2"	60,3	190,0	●
2 1/2"	76,1	240,0	●

● = sandėliuojama ○ = užsakoma

pardavimai@busgeriau.lt +37066276762

01 Srieginės jungtys

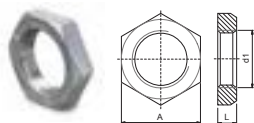

Veržlė 10 bar

d1	A	L	AISI 316
1/8"	19,0	8,5	●
1/4"	22,0	8,5	●
3/8"	27,0	9,0	●
1/2"	32,0	9,0	●
3/4"	36,0	10,0	●
1"	46,0	11,0	●
1 1/4"	55,0	12,0	●
1 1/2"	60,0	13,0	●
2"	75,0	13,5	●
2 1/2"	90,0	17,5	●
3"	100,0	21,0	●
4"	130,0	22,0	●

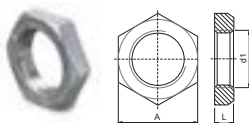

Veržlė 40-100 bar

d1	A	L	EN 1.4404
1/8"	17,0	7,0	○
1/4"	22,0	8,0	●
3/8"	27,0	9,0	●
1/2"	32,0	9,0	●
3/4"	36,0	10,0	●
1"	46,0	11,0	●
1 1/4"	55,0	13,0	●
1 1/2"	60,0	13,0	●
2"	75,0	14,0	●
2 1/2"	95,0	16,0	○
3"	105,0	19,0	○

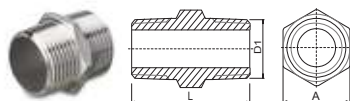

Nipelis 10 bar

D1	A	L	AISI 316
1/8"	12,0	20,0	●
1/4"	15,0	25,0	●
3/8"	19,0	27,0	●
1/2"	23,0	34,0	●
3/4"	29,0	36,5	●
1"	36,0	42,0	●
1 1/4"	45,0	47,5	●
1 1/2"	51,0	47,5	●
2"	63,0	57,0	●
2 1/2"	80,0	62,0	●
3"	95,0	67,5	●
4"	120,0	80,0	●

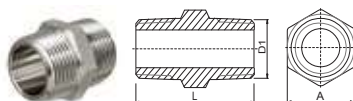

Nipelis 40-100 bar

D1	A	L	EN 1.4404
1/8"	12,0	21,0	●
1/4"	14,0	28,0	●
3/8"	19,0	29,0	●
1/2"	22,0	36,0	●
3/4"	30,0	41,0	●
1"	36,0	46,5	●
1 1/4"	46,0	54,0	●
1 1/2"	50,0	54,0	●
2"	65,0	65,5	●
2 1/2"	80,0	76,5	○
3"	90,0	85,0	○
4"	126,0	94,0	○

● = sandėliuojama ○ = užsakoma

pardavimai@busgeriau.lt +37066276762

01 Srieginės jungtys

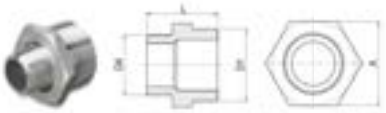

Nipelis, redukcinis

D1 x D4	A	10 bar	
		L	AISI 316
1/4" x 1/8"	15,0	22,5	●
3/8" x 1/8"	19,0	24,0	●
3/8" x 1/4"	19,0	26,5	●
1/2" x 1/8"	23,0	27,5	●
1/2" x 1/4"	23,0	30,0	●
1/2" x 3/8"	23,0	30,5	●
3/4" x 1/4"	29,0	31,5	●
3/4" x 3/8"	29,0	32,0	●
3/4" x 1/2"	29,0	35,5	●
1" x 1/4"	36,0	34,5	●
1" x 3/8"	36,0	35,0	●
1" x 1/2"	36,0	38,5	●
1" x 3/4"	36,0	39,5	●
1 1/4" x 1/2"	45,0	41,5	●
1 1/4" x 3/4"	45,0	42,5	●
1 1/4" x 1"	45,0	45,0	●
1 1/2" x 1/2"	51,0	41,5	●
1 1/2" x 3/4"	51,0	42,5	●
1 1/2" x 1"	51,0	45,0	●
1 1/2" x 1 1/4"	51,0	47,5	●
2" x 1/2"	63,0	46,5	●
2" x 3/4"	63,0	47,5	●
2" x 1"	63,0	50,0	●
2" x 1 1/4"	63,0	52,5	●
2" x 1 1/2"	63,0	52,5	●
2 1/2" x 1 1/2"	80,0	54,5	●
2 1/2" x 2"	80,0	59,0	●
3" x 2"	95,0	62,5	●
3" x 2 1/2"	95,0	64,5	●
4" x 3"	120,0	74,0	●

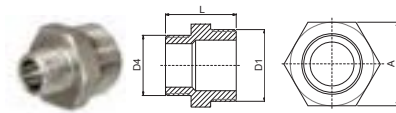

Nipelis, redukcinis

D1 x D4	A	40-100 bar	
		L	EN 1.4404
1/4" x 1/8"	14,0	25,0	●
3/8" x 1/8"	19,0	25,5	○
3/8" x 1/4"	19,0	29,0	●
1/2" x 1/8"	22,0	30,0	○
1/2" x 1/4"	22,0	33,0	●
1/2" x 3/8"	22,0	33,5	●
3/4" x 1/4"	30,0	37,0	●
3/4" x 3/8"	30,0	37,0	●
3/4" x 1/2"	30,0	40,5	●
1" x 1/4"	36,0	40,0	○
1" x 3/8"	36,0	40,5	○
1" x 1/2"	36,0	44,0	●
1" x 3/4"	36,0	45,5	●
1 1/4" x 1/2"	46,0	48,0	●
1 1/4" x 3/4"	46,0	49,5	●
1 1/4" x 1"	46,0	52,0	●
1 1/2" x 1/2"	50,0	48,0	○
1 1/2" x 3/4"	50,0	49,0	○
1 1/2" x 1"	50,0	52,0	●
1 1/2" x 1 1/4"	50,0	54,0	●
2" x 1"	65,0	59,0	●
2" x 1 1/4"	65,0	62,0	●
2" x 1 1/2"	65,0	62,0	○
2 1/2" x 2"	80,0	73,0	○
3" x 2"	90,0	78,0	○
3" x 2 1/2"	90,0	82,0	○

01 Srieginės jungtys



Jungtis I/V redukcinė

10 bar

D1 x D2	A	h	AISI 316
1/4" x 1/8"	16,5	16,0	●
3/8" x 1/8"	21,8	16,0	●
3/8" x 1/4"	21,8	18,5	●
1/2" x 1/8"	25,5	20,0	●
1/2" x 1/4"	25,5	20,0	●
1/2" x 3/8"	25,5	20,0	●
3/4" x 1/8"	31,5	25,0	●
3/4" x 1/4"	31,5	25,0	●
3/4" x 3/8"	31,5	25,0	●
3/4" x 1/2"	31,5	25,0	●
1" x 1/4"	38,0	30,5	●
1" x 3/8"	38,0	30,5	●
1" x 1/2"	38,0	30,5	●
1" x 3/4"	38,0	30,5	●
1 1/4" x 1/2"	46,0	31,5	●
1 1/4" x 3/4"	46,0	31,5	●
1 1/4" x 1"	46,0	31,5	●
1 1/2" x 1/2"	51,8	33,5	●
1 1/2" x 3/4"	51,8	33,5	●
1 1/2" x 1"	51,8	33,5	●
1 1/2" x 1 1/4"	51,8	33,5	●
2" x 1/2"	62,5	34,0	●
2" x 3/4"	62,5	34,0	●
2" x 1"	62,5	34,0	●
2" x 1 1/4"	62,5	34,0	●
2" x 1 1/2"	62,5	34,0	●
2 1/2" x 1 1/2"	79,5	42,0	●
2 1/2" x 2"	79,5	42,0	●
3" x 1 1/2"	94,5	42,0	●
3" x 2"	94,5	42,0	●
3" x 2 1/2"	94,5	42,0	●
4" x 2"	118,0	45,0	●
4" x 2 1/2"	118,0	45,0	●
4" x 3"	118,0	45,0	●

Jungtis I/V redukcinė

40-100 bar

D1 x D2	A	h	EN 1.4404
1/4" x 1/8"	14,0	11,0	●
3/8" x 1/8"	19,0	11,5	○
3/8" x 1/4"	19,0	11,5	●
1/2" x 1/8"	22,0	21,0	●
1/2" x 1/4"	22,0	21,0	●
1/2" x 3/8"	22,0	21,0	●
3/4" x 1/4"	30,0	24,5	●
3/4" x 3/8"	30,0	24,5	●
3/4" x 1/2"	30,0	24,5	●
1" x 1/4"	36,0	27,0	●
1" x 3/8"	36,0	27,0	●
1" x 1/2"	36,0	27,0	●
1" x 3/4"	36,0	27,0	●
1 1/4" x 1/2"	46,0	32,5	○
1 1/4" x 3/4"	46,0	32,5	●
1 1/4" x 1"	46,0	32,5	●
1 1/2" x 1/2"	50,0	32,5	●
1 1/2" x 3/4"	50,0	32,5	●
1 1/2" x 1"	50,0	32,5	●
1 1/2" x 1 1/4"	50,0	32,5	●
2" x 1"	65,0	40,0	○
2" x 1 1/4"	65,0	40,0	●
2" x 1 1/2"	65,0	40,0	●
2 1/2" x 2"	80,0	46,0	○
3" x 2"	90,0	51,5	○
3" x 2 1/2"	90,0	51,5	○

● = sandėliuojama

○ = užsakoma

pardavimai@busgeriau.lt +37066276762

01 Srieginės jungtys



Aklė, išorė 10 bar

3096 su smailėjančiu sriegiu

D	D2	A	h	AISI 316
1/8"	-	14,0	12,0	●
1/4"	-	17,0	16,0	●
3/8"	11,3	21,0	16,0	●
1/2"	14,6	26,0	19,5	●
3/4"	19,9	32,0	21,0	●
1"	25,8	38,0	24,0	●
1 1/4"	34,5	46,0	27,0	●
1 1/2"	39,5	52,0	27,0	●
2"	51,5	65,0	32,0	●
2 1/2"	61,2	80,0	34,0	●
3"	76,8	95,0	37,5	●
4"	102,3	120,0	44,0	●

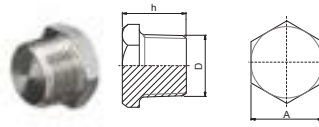

Aklė, išorė

40-100 bar

3097 su smailėjančiu sriegiu

D	A	h	EN 1.4404
1/8"	13,0	14,0	●
1/4"	14,0	17,0	●
3/8"	19,0	17,0	●
1/2"	23,0	21,0	●
3/4"	30,0	24,0	●
1"	36,0	27,0	●
1 1/4"	46,0	32,0	●
1 1/2"	50,0	33,0	●
2"	65,0	38,0	●
2 1/2"	80,0	45,0	○
3"	90,0	48,0	○



Aklė, išorė 10 bar

3095 su lygiagrečiu sriegiu

D	D2	A	h	AISI 316
1/8"	-	14,0	12,0	●
1/4"	-	17,0	16,0	●
3/8"	11,3	21,0	16,0	●
1/2"	14,6	26,0	19,5	●
3/4"	19,9	32,0	21,0	●
1"	25,8	38,0	24,0	●
1 1/4"	34,5	46,0	27,0	●
1 1/2"	39,5	52,0	27,0	●
2"	51,5	65,0	32,0	●

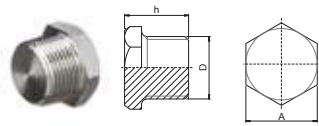

Aklė, išorė

40-100 bar

3098 su lygiagrečiu sriegiu

D	A	h	EN 1.4404
1/8"	14,0	13,0	○
1/4"	19,0	16,0	○
3/8"	22,0	17,0	○
1/2"	27,0	22,0	●
3/4"	32,0	24,0	○
1"	41,0	28,0	○

01 Srieginės jungtys

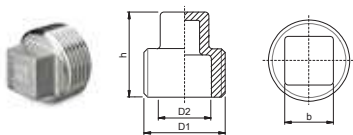

Aklė, kvad.I 10 bar

3105 su smailėjančiu sriegiu

D1	D2	b	h	
1/8"	-	7,0	11,0	●
1/4"	-	9,0	15,3	●
3/8"	-	10,0	16,4	●
1/2"	14,3	13,0	20,6	●
3/4"	21,0	18,0	22,1	●
1"	25,7	19,0	28,2	●
1 1/4"	33,3	23,0	29,0	●
1 1/2"	39,3	26,0	29,9	●
2"	52,0	29,0	34,5	●
2 1/2"	60,0	40,0	38,5	●
3"	75,8	44,0	45,0	●
4"	99,4	59,0	52,0	●

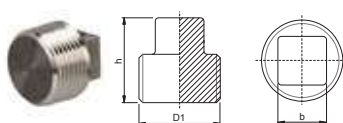

Aklė, kvad.I

3106 su smailėjančiu sriegiu

40-100 bar

D1	b	h	EN 1.4404
1/8"	7,0	16,0	●
1/4"	9,0	18,0	●
3/8"	10,0	20,0	●
1/2"	11,0	22,0	●
3/4"	16,0	27,0	●
1"	19,0	32,0	●
1 1/4"	22,0	36,0	●
1 1/2"	22,0	37,0	●
2"	27,0	43,0	●
2 1/2"	32,0	46,0	○
3"	36,0	50,0	○



Žarnos nipelis 10 bar

D1 x d3 (mm)	A	L	AISI 316
1/8" x 7,0	13,0	45,0	●
1/4" x 9,0	16,0	46,5	●
1/4" x 11,0	16,0	46,5	●
3/8" x 11,0	19,0	51,5	●
1/2" x 13,0	25,0	62,5	●
1/2" x 14,5	25,0	62,5	●
1/2" x 19,0	25,0	62,5	●
3/4" x 16,0	31,0	72,5	●
3/4" x 20,5	31,0	72,5	●
1" x 25,0	38,0	82,0	●
1" x 26,5	38,0	82,0	●
1 1/4" x 34,0	46,0	80,0	●
1 1/2" x 40,5	52,0	92,5	●
2" x 51,0	65,0	109,5	●
2" x 52,5	65,0	109,5	●
2 1/2" x 64,0	80,0	136,0	●
3" x 78,0	95,0	147,0	●



Žarnos nupelis 20 bar

3115 – su sriegtu galu
3120 – su virinamu galu

D	d	L	AISI 316
1/4"	13,5	70,0	●
3/8"	17,2	70,0	●
1/2"	21,3	70,0	●
3/4"	26,9	70,0	●
1"	33,7	70,0	●
1 1/4"	42,4	70,0	●
1 1/2"	48,3	100,0	●
2"	60,3	100,0	●

● = sandėliuojama ○ = užsakoma

02 Virinamos jungtys

02 Virinamos jungtys



Alkūnė 90°, Tipas 3D EN 10253-3/4A, ISO

DN	D x T	R	4000			5000			5000		
			EN 1.4307	EN 1.4404	EN 1.4432	EN 1.4307	EN 1.4404	EN 1.4432	EN 1.4307	EN 1.4404	EN 1.4432
8	13,5 x 1,6	20,5	○	●		100	101,6 x 2,0	133,0	●	●	
			○	●		100	114,3 x 2,0	152,5	●	●	○
			○	●			2,6			●	●
10	17,2 x 1,6	28,5	●	●			3,0		●	●	○
			●	●			4,0		●	●	
			○	○	○	125	139,7 x 2,0	190,5	●	●	○
15	21,3 x 1,6	31,8	●	●			3,0		●	●	○
			●	●			4,0		○	○	○
			○	○	○	150	168,3 x 2,0	228,5	●	●	○
20	26,9 x 1,6	28,5	●	●			3,0		●	●	○
			●	●			4,0		○	○	○
			○	○	○	200	219,1 x 2,0	305,0	●	●	○
25	33,7 x 1,6	38,0	●	●			3,0		●	●	○
			●	●			4,0		○	○	○
			○	○	○	250	273,0 x 2,0	385,0	●	●	○
32	42,4 x 1,6	47,6	●	●			3,0		●	●	○
			●	●			4,0		○	○	○
			○	○	○	300	323,9 x 3,0	457,0	●	●	○
40	48,3 x 1,6	57,1	●	●			4,0		○	○	○
			●	●			4,0		○	○	○
			○	○	○	350	355,6 x 3,0	534,0	●	●	○
50	60,3 x 1,6	76,2	●	●			4,0		○	○	○
			●	●			4,0		○	○	○
			○	○	○	400	406,4 x 3,0	610,0	●	●	○
65	76,1 x 1,6	96,0	●	●			4,0		○	○	○
			●	●			4,0		○	○	○
			○	○	○	450	457,2 x 3,0	686,0	○	○	○
80	88,9 x 1,6	114,3	●	●			4,0		○	○	○
			●	●			4,0		○	○	○
			○	○	○	500	508,0 x 3,0	762,0	●	●	○
100	101,6 x 2,0	133,0	●	●			5,0		○	○	○
			●	●			5,0		○	○	○
			○	○	○	600	609,6 x 3,0	914,0	○	○	○
125	139,7 x 2,0	190,5	●	●			4,0		○	○	○
			●	●			4,0		○	○	○
			○	○	○	700	711,2 x 4,0	1066,0	○	○	
150	168,3 x 2,0	228,5	●	●			5,0		○	○	
			●	●			5,0		○	○	
			○	○	○	800	812,8 x 4,0	1219,0	○	○	
200	219,1 x 2,0	305,0	●	●			4,0		○	○	
			●	●			4,0		○	○	
			○	○	○	900	914,4 x 5,0	1371,0	○	○	
250	273,0 x 2,0	385,0	●	●			4,0		○	○	
			●	●			4,0		○	○	
			○	○	○	1000	1016,0 x 6,0	1524,0	○	○	

● = sandėliuojama ○ = užsakoma
s = poliruojama

02 Virinamos jungtys



Alkūnė 90°, Tipas 3D

EN 10253-3/4A, DIN / Metrinis

DN	D x T	R	4005	5005	5005
			EN 1.4307	EN 1.4404	EN 1.4432
15	16,0 x 1,5	24,0	●	○	
	18,0 x 1,5	27,0	●	○	
20	20,0 x 1,5	30,0	●	●	
	2,0		●	●	
25	25,0 x 1,5	38,0	●	●	
	2,0		●	●	
30	28,0 x 1,5	42,0	●	●	
	2,0		●	●	
32	30,0 x 1,5	45,0	●	○	
	2,0		●	●	
40	30,0 x 1,5	45,0	●	●	
	2,0		●	●	
50	32,0 x 2,0	48,0	○	○	
	35,0 x 2,0	45,0	●	○	○
65	2,0		●	○	
	38,0 x 1,5	57,0	●	●	
80	2,0		○	●	○
	2,0		●	●	
100	40,0 x 2,0	60,0	●	●	
	43,0 x 1,5	64,5	●	○	
125	44,5 x 2,0	51,0	●	●	○
	66,0		●	●	
150	50,8 x 2,0	75,0	●	●	
	54,0 x 2,0	68,5	●	●	○
200	57,0 x 2,0	77,0	●	○	
	63,5 x 2,0	94,5	○	●	
250	70,0 x 2,0	92,0	●	●	

DN	D x T	R	4005	5005	5005
			EN 1.4307	EN 1.4404	EN 1.4432
80	84,0 x 2,0	126,0	●	●	●
	86,0 x 3,0	126,0	○	○	○
100	104,0 x 2,0	150,0	●	●	●
	106,0 x 3,0	150,0	○	●	○
125	108,0 x 2,0	142,5	●	○	
	129,0 x 2,0	187,5	●	●	●
150	131,0 x 3,0	187,5	○	○	○
	154,0 x 2,0	225,0	●	●	●
200	156,0 x 3,0	225,0	●	●	○
	204,0 x 2,0	300,0	●	●	●
250	206,0 x 3,0	300,0	●	●	●
	254,0 x 2,0	375,0	●	●	○
300	256,0 x 3,0	375,0	●	●	○
	304,0 x 2,0	450,0	●	●	○
350	306,0 x 3,0	450,0	●	●	○
	356,0 x 3,0	525,0	●	●	○
400	406,0 x 3,0	600,0	●	●	○
	408,0 x 4,0	600,0	○	○	○
450	456,0 x 3,0	675,0	○	○	○
	458,0 x 4,0	675,0	○	○	○
500	506,0 x 3,0	750,0	●	●	○
	508,0 x 4,0	750,0	○	○	○
600	606,0 x 3,0	900,0	○	○	○
	608,0 x 4,0	900,0	○	○	○
700	708,0 x 4,0	1050,0	○	○	○
	800	808,0 x 4,0	1200,0	○	○

● = sandėliuojama

○ = užsakoma

pardavimai@busgeriau.lt +37066276762

02 Virinamos jungtys

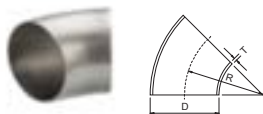

Alkūnė 45°, Tipas 3D

EN 10253-3/4A, ISO

4000-45 5000-45

DN	D x T	R	EN 1.4307	EN 1.4404
15	21,3 x 2,0	31,8	○	●
20	26,9 x 2,0	28,5	○	●
25	33,7 x 2,0	38,0	○	●
32	42,4 x 2,0	47,6	○	●
40	48,3 x 2,0	57,1	○	●
50	60,3 x 2,0	76,2	○	●
65	76,1 x 2,0	96,0	○	●
80	88,9 x 2,0	114,3	○	●
100	114,3 x 2,0	152,5	○	●
125	139,7 x 2,0	190,5	○	●
150	168,3 x 2,0	228,5	○	●
200	219,1 x 2,0	305,0	○	●



Alkūnė 90°, Tipas D+100

EN 10253-3/4A, DIN / Metrinis

4006 5006 5006

DN	D x T	R	EN 1.4307	EN 1.4404	EN 1.4432
250	254,0 x 2,0	350,0	●	●	●
	256,0 x 3,0	350,0	●	●	●
300	304,0 x 2,0	400,0	●	●	●
	306,0 x 3,0	400,0	●	●	●
350	356,0 x 3,0	450,0	●	●	●
400	406,0 x 3,0	500,0	●	●	●
	408,0 x 4,0	500,0	○	○	○
450	456,0 x 3,0	550,0	○	●	●
	458,0 x 4,0	550,0	○	○	○
500	506,0 x 3,0	600,0	●	●	●
	508,0 x 4,0	600,0	○	○	○
600	606,0 x 3,0	700,0	●	●	●
	608,0 x 4,0	700,0	○	○	○
700	708,0 x 4,0	800,0	○	○	○
800	808,0 x 4,0	900,0	○	○	○



Alkūnė 90°, Tipas 5D (ilgas spindulys)

EN 10253-3/4A, ISO

4000-5D 5000-5D

DN	D x T	R	EN 1.4307	EN 1.4404
15	21,3 x 2,0	45,0	○	●
20	26,9 x 2,0	57,0	○	●
25	33,7 x 2,0	72,0	○	●
32	42,4 x 2,0	93,0	○	●
40	48,3 x 2,0	108,0	○	●
50	60,3 x 2,0	135,0	○	●
65	76,1 x 2,0	175,0	○	●
80	88,9 x 2,0	205,0	○	●
100	114,3 x 2,0	270,0	○	●
125	139,7 x 2,0	330,0	○	●
150	168,3 x 2,0	390,0	○	●
200	219,1 x 2,0	510,0	○	●



Alkūnė 90°, Tipas 5D (ilgas spindulys)

EN 10253-3/4A, DIN / Metrinis

4005-5D 5005-5D

DN	D x T	R	EN 1.4307	EN 1.4404
80	84,0 x 2,0	160,0 mm	○	●
100	104,0 x 2,0	200,0 mm	○	●
125	129,0 x 2,0	250,0 mm	○	●
150	154,0 x 2,0	375,0 mm	○	●
200	204,0 x 2,0	500,0 mm	○	●

● = sandėliuojama ○ = užsakoma pardavimai@busgeriau.lt +37066276762

02 Virinamos jungtys

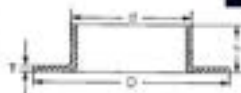
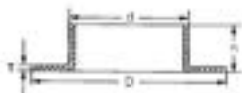

Virinamas žiedas, trumpas

PN10

EN 1092-1 Tipas 33, ISO

Virinamas žiedas, ilgas

PN16

EN 1092-1 Tipas 33, ISO

DN	d	T	D	h	4010		4015		
					EN 1.4307	EN 1.4404	EN 1.4307	EN 1.4404	EN 1.4432
15	21,3	2	45	6	○	●	○	● ³⁷	○
		3		8	○	●			
20	26,9	2	58	8	○	●	○	● ³⁷	○
		3		8	○	●			
25	33,7	2	68	9	●	●	○	● ³⁷	○
		3		10	○	●			
32	42,4	2	78	10	●	●	○	●	●
		3		10	○	●			
40	48,3	2	88	10	●	●	○	●	●
		3		10	○	●			
50	60,3	2	102	12	●	●	○	●	○
		3		12	●	●			
65	76,1	2	122	12	●	●	○	●	○
		3		12	●	●			
80	88,9	2	138	13	●	●	○	●	○
		3		13	●	●			
100	114,3	2	158	14	●	●	○	●	○
		3		14	●	●			
125	139,7	2	188	15	●	●	○	●	○
		3		15	●	●			
150	168,3	2	212	18	●	●	○	●	○
		3		18	●	●			
200	219,1	2	268	22	●	●	○	●	○
		3		22	●	●			
250	273,0	2	320	23	●	●	○	●	○
		3		23	●	●			
300	323,9	3	370	19	●	●	○	●	○
350	355,6	3	430	30	○	○			
400	406,4	3	480	30	○	○	○	●	○
		4		30	○	○			
450	457,2	3	530	30	○	○	○	●	○
		4		30	○	○			
500	508,0	3	580	30/50	○	○	○	●	○
		4		30/50	○	○			
600	609,6	3	680	30/50	○	○	○	●	○
		4		30/50	○	○			
700	711,2	4	800	50	○	○	○	●	○
		5		50	○	○			
800	812,8	4	905	60	○	○	○	●	○
		5		60	○	○			
900	914,4	5	1005	60	○	○	○	●	○
1000	1016,0	6	1110	60	○	○			

● = sandėliuojamas

○ = užsakomas

³⁷ = Tipas 37



02 Virinamos jungtys

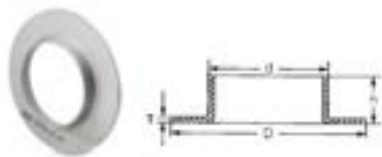

Virinamas žiedas, trumpas PN10

EN 1092-1 Tipas 33, DIN / Metrinis

DN	d	T	D	h	4015	5015
					EN 1.4307	EN 1.4404
32	38,0	2	78	10	○	●
40	44,0	2	88	10	○	●
	46,0	3	88	10	○	○
50	54,0	2	102	12	●	●
	56,0	3	102	12	○	●
65	70,0	2	122	12	●	●
	71,0	3	122	12	○	●
80	84,0	2	138	13	●	●
	86,0	3	138	13	○	●
100	104,0	2	158	16	●	●
	106,0	3	158	16	●	●
125	129,0	2	188	14	●	●
	131,0	3	188	14	●	●
150	154,0	2	212	18	●	●
	156,0	3	212	18	●	●
200	204,0	2	268	21	●	●
	206,0	3	268	21	●	●
250	254,0	2	320	23	●	●
	256,0	3	320	23	●	●
300	304,0	2	370	19	●	●
	306,0	3	370	19	●	●
350	356,0	3	430	23	●	●
400	406,0	3	480	21	●	●
	408,0	4	480	30	○	○
450	456,0	3	530	25	○	●
	458,0	4	530	30	○	○
500	506,0	3	580	26	●	●
	508,0	4	580	30 / 50	○	○
600	606,0	3	680	30	○	●
	608,0	4	680	30 / 50	○	○
700	708,0	4	800	50	○	○
800	808,0	4	880	60	○	○

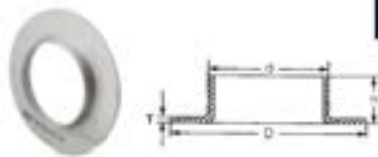

Virinamas žiedas, ilgas PN16

EN 1092-1 Tipas 33, DIN / Metrinis

DN	d	D	T	h	4010	5015	5015
					EN 1.4307	EN 1.4404	EN 1.4432
40	46,0	88	3	16	○	○	○
50	56,0	102	3	16	○	●	●
65	71,0	122	3	19	○	○	○
80	86,0	138	3	20	○	●	●
100	106,0	158	3	22	○	●	●
125	131,0	188	3	25	○	●	●
150	156,0	212	3	25	○	●	●
200	206,0	268	3	25	○	●	●
250	256,0	320	3	26	○	●	●
300	306,0	370	3	26	○	●	●
350	356,0	430	3	26	○	●	●
400	406,0	480	3	30	○	●	●
450	456,0	530	3	30	○	●	●
500	506,0	580	3	30	○	●	●
600	606,0	680	3	30	○	●	●

● = sandėliuojama ○ = užsakoma pardavimai@busgeriau.lt +37066276762

02 Virinamos jungtys

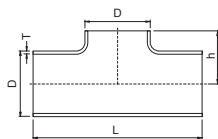
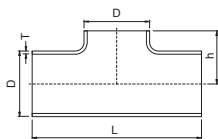

Trišakis

EN 10253-3/4A, ISO

Trišakis

EN 10253-3/4A, DIN / Metrinis

4030 5030

DN	D	T	h	L	EN	
					1.43071.4404	5030
10	17,2	1,6	12	51	○	●
15	21,3	2,0	18	50	●	●
20	26,9	2,0	22	58	●	●
		2,5	22	58	○	●
		2,6	22	58	○	●
25	33,7	2,0	26	76	●	●
		3,0	26	76	○	●
		3,2	26	76	○	●
32	42,4	2,0	33	95	●	●
		3,0	33	95	○	●
		3,2	33	95	○	●
40	48,3	2,0	37	114	●	●
		3,0	37	114	○	●
		3,2	37	114	○	●
50	60,3	2,0	44	127	●	●
		3,0	44	127	○	●
		3,2	44	127	○	●
65	76,1	2,0	53	152	●	●
		3,0	53	152	○	●
		3,2	53	152	○	●
80	88,9	2,0	60	171	●	●
		3,0	60	171	○	●
		3,2	60	171	○	●
100	114,3	2,0	77	210	●	●
		3,0	77	210	●	●
		3,2	77	210	●	●
125	139,7	2,0	81	248	●	●
		3,0	81	248	●	●
		3,2	81	248	●	●
150	168,3	2,0	96	286	●	●
		3,0	96	286	●	●
		3,2	96	286	●	●
200	219,1	2,0	120	356	●	●
		3,0	120	356	●	●
		3,2	120	356	●	●
250	273,0	3,0	148	432	●	●
		3,2	148	432	●	●
		3,0	148	432	●	●
300	323,9	3,0	177	600	●	●

4035 5035

DN	D	T	h	L	EN	
					1.43071.4404	5035
20	25,0	2,0	20	51	○	●
25	30,0	2,0	24	76	○	●
32	38,0	2,0	29	95	○	●
40	44,5	2,0	34	95	○	●
50	54,0	2,0	41	114	○	●
65	70,0	2,0	50	140	○	●
80	84,0	2,0	58	171	○	●
100	104,0	2,0	70	210	●	●
125	129,0	2,0	74	248	●	●
150	154,0	2,0	88	286	●	●
		3,0	84	286	○	●
200	204,0	2,0	114	356	●	●
		3,0	110	356	○	●
250	254,0	2,0	140	432	●	●
		3,0	140	432	○	●
300	306,0	3,0	168	600	●	●
350	356,0	3,0	195	700	●	●
400	406,0	3,0	220	800	●	●

● = sandėliuojamas ○ = užsakomas

pardavimai@busgeriau.lt +37066276762

02 Virinamos jungtys

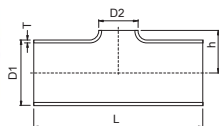
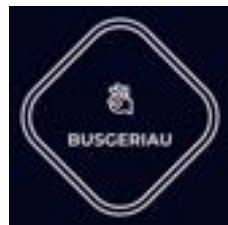

Trišakis, redukcinis EN 10253-3/4A, ISO

5030R

5030R

DN1	DN2	D1	D2	T	h	L	EN 1.4404
20	15	26,9	21,3	2	15	57	●
25	15	33,7	21,3	2	19	76	●
	20		26,9	2	19	76	●
32	15	42,4	21,3	2	23	95	●
	20		26,9	2	23	95	●
	25		33,7	2	23	95	●
40	15	48,3	21,3	2	26	114	●
	20		26,9	2	26	114	●
	25		33,7	2	26	114	●
	32		42,4	2	26	114	●
50	15	60,3	21,3	2	33	127	●
	20		26,9	2	33	127	●
	25		33,7	2	33	127	●
	32		42,4	2	33	127	●
40			48,3	2	33	127	●
65	15	76,1	21,3	2	41	152	●
	20		26,9	2	41	152	●
	25		33,7	2	41	152	●
	32		42,4	2	41	152	●
	40		48,3	2	41	152	●
50			60,3	2	41	152	●
80	15	88,9	21,3	2	48	171	●
	20		26,9	2	48	171	●
	25		33,7	2	48	171	●
	32		42,4	2	48	171	●
	40		48,3	2	48	171	●
	50		60,3	2	48	171	●
65			76,1	2	48	171	●
100	40	114,3	48,3	2	61	210	●
	50		60,3	2	61	210	●
	65		76,1	2	61	210	●
	80		88,9	2	61	210	●
125	50	139,7	60,3	2	76	248	●
	65		76,1	2	76	248	●
	80		88,9	2	76	248	●
	100		114,3	2	76	248	●
150	50	168,3	60,3	2	92	286	●
	65		76,1	2	92	286	●
	80		88,9	2	92	286	●
	100		114,3	2	92	286	●
	125		139,7	2	92	286	●

DN1	DN2	D1	D2	T	h	L	EN 1.4404
200	100	219,1	114,3	2	118	356	●
	125		139,7	2	118	356	●
	150		168,3	2	118	356	●
250	150	273,0	168,3	3	148	432	●
	200		219,1	3	148	432	●
300	150	323,9	168,3	3	178	508	●
	200		219,1	3	178	508	●
	250		273,0	3	178	508	●

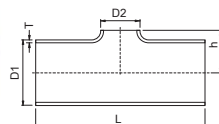

Trišakis, redukcinis EN 10253-3/4A, DIN / Metrinis

5035R

DN1	DN2	D1	D2	T	h	L	EN 1.4404
80	50	84,0	54,0	2	45	171	●
100	50	104,0	54,0	2	55	210	●
	80		84,0	2	55	210	●
125	80	129,0	84,0	2	69	258	●
	100		104,0	2	69	258	●
150	100	154,0	104,0	2	84	286	●
	125		129,0	2	84	286	●
200	100	204,0	104,0	2	110	356	●
	125		129,0	2	110	356	●
	150		154,0	2	110	356	●
250	100	254,0	104,0	2	140	432	●
	125		129,0	2	140	432	●
	150		154,0	2	140	432	●
	200		204,0	2	140	432	●

● = sandėliuojama ○ = užsakoma pardavimai@busgeriau.lt +37066276762

02 Virinamos jungtys

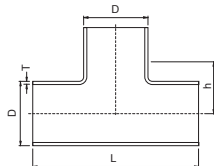

Trišakis, lygiašonis

EN 10253-3/4A, ISO

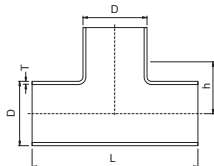

Trišakis, lygiašonis

EN 10253-3/4A, DIN / Metrinis

4030V 5030V

DN	D	T	h	L	EN	
					1.4307	1.4404
300	323,3	3,0	254	508	●	●
		4,0	254	508	○	○
350	355,6	3,0	279	558	○	○
		4,0	279	558	○	○
400	406,4	3,0	305	610	○	○
		4,0	305	610	○	○
450	457,2	3,0	343	686	○	○
		4,0	343	686	○	○
500	508,0	3,0	381	762	○	○
		4,0	381	762	○	○
600	606,9	3,0	432	864	○	○
		4,0	432	864	○	○
700	711,2	4,0	521	1042	○	○
		5,0	521	1042	○	○
800	812,8	4,0	597	1194	○	○
		5,0	597	1194	○	○
900	914,4	5,0	673	1346	○	○
		6,0	749	1498	○	○

Busgeriau nr.

4035V 5035V

DN	D	T	h	L	EN	
					1.4307	1.4404
400	406,0	3	305	610	○	○
		4	305	610	○	○
450	456,0	3	343	686	○	○
		4	343	686	○	○
500	506,0	3	381	762	○	○
		4	381	762	○	○
600	606,0	3	432	864	○	○
		4	432	864	○	○
700	708,0	4	700	1400	○	○
		4	800	1600	○	○

● = sandėliuojamas ○ = užsakomas

pardavimai@busgeriau.lt +37066276762



02 Virinamos jungtys

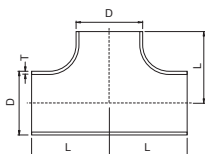

Presuotas trišakis

EN 10253-3/4A, ISO

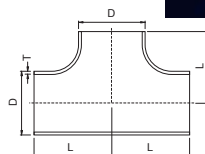

Presuotas trišakis

EN 10253-3/4A, DIN / Metrinis

DN	D	T	L	EN 1.4404 1.4432
10	17,2	2,0	25	●
15	21,3	2,0	25	●
20	26,9	2,0	29	●
25	33,7	2,0	38	●
32	42,4	2,0	48	●
40	48,3	2,0	57	●
50	60,3	2,0	64	●
65	76,1	2,0	76	●
80	88,9	2,0	86	●
100	114,3	2,0	105	●
125	139,7	2,6	124	●
150	168,3	3,0	143	●
200	219,1	3,0	178	●
250	273,0	3,0	216	●
300	323,9	3,0	254	○
350	355,6	3,0	279	○
400	406,4	3,0	305	○
450	457,2	4,0	343	○
500	508,0	4,0	381	○
600	609,6	5,0	432	○

DN	D	T	L	EN 1.4404 1.4432
15	20,0	2,0	25	○
20	25,0	2,0	30	○
25	30,0	2,0	35	○
32	38,0	2,0	43	○
40	44,5	2,0	50	○
50	54,0	2,0	61	○
65	70,0	2,0	73	○
80	84,0	2,0	80	●
100	104,0	2,0	90	●
125	129,0	2,0	115	●
150	154,0	2,0	135	●
200	206,0	3,0	175	●
250	256,0	3,0	216	●
300	306,0	3,0	254	●
350	356,0	3,0	279	○
400	406,0	3,0	305	○
	408,0	4,0	305	○
450	456,0	3,0	343	○
	458,0	4,0	343	○
500	506,0	3,0	381	○
	508,0	3,0	381	○
600	606,0	3,0	432	○
	608,0	4,0	432	○

02 Virinamos jungtys



Redukcijos

EN 10253-3, ISO

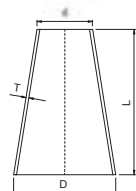

DN	DN1	D	d	T	5040 Koncentr. DIN2616		5041 Koncentr. L=D-dx3		5042 Ekscentrinės L=D-dx3	
					L	EN 1.4404	L	EN 1.4404	L	EN 1.4404
10	8	17,2	13,5	2,0			11	●	11	○
15	10	21,3	17,2	2,0			12	●	12	○
20	10	26,9	17,2	2,0			29	●	29	○
	15		21,3	2,0	38	●	17	●	17	○
25	10	33,7	17,2	2,0			49	●	49	○
	15		21,3	2,0	51	●	37	●	37	●
	20		26,9	2,0	51	●	20	●	20	●
32	15	42,4	21,3	2,0			63	●	63	○
	20		26,9	2,0	51	●	46	●	46	●
	25		33,7	2,0	51	●	26	●	26	●
40	15	48,3	21,3	2,0			81	●	81	●
	20		26,9	2,0	64	●	64	●	64	●
	25		33,7	2,0	64	●	44	●	44	●
	32		42,4	2,0	64	●	18	●	18	●
50	15	60,3	21,3	2,0			117	●	117	○
	20		26,9	2,0			100	●	100	●
	25		33,7	2,0	76	●	80	●	80	●
	32		42,4	2,0	76	●	54	●	54	●
	40		48,3	2,0	76	●	36	●	36	●
65	25	76,1	33,7	2,0			127	●	127	○
	32		42,4	2,0			101	●	101	●
	40		48,3	2,0	89	●	83	●	83	●
			48,3	3,0			83	●	83	○
	50		60,3	2,0	89	●	47	●	47	●
				3,0			47	●	47	○
80	25	88,9	33,7	2,0			166	●	166	○
	32		42,4	2,0			139	●	139	○
	40		48,3	2,0			122	●	122	●
	50		60,3	2,0	89	●	86	●	86	●
				3,0			86	●	86	○
	65		76,1	2,0	89	●	38	●	38	●
				3,0			38	●	38	○
100	40	114,3	48,3	2,0			197	●	197	○
	50		60,3	2,0			162	●	162	●
	65		76,1	2,0	102	○	115	●	115	●
				3,0	102	○	115	●	115	○
	80		88,9	2,0	102	○	76	●	76	●
				3,0	102	○	76	●	76	●
125	50	139,7	60,3	2,0			237	●	237	○
	65		76,1	2,0			189	●	189	○
				3,0			189	●	189	○
	80		88,9	2,0	127	○	152	●	152	●
				3,0	127	○	152	●	152	●
	100		114,3	2,0	127	○	76	●	76	●
				3,0	127	○	76	●	76	●

● = sandėliuojama

○ = užsakoma

pardavimai@busgeriau.lt + 37066276762

Tesinys kitame puslapyje

02 Virinamos jungtys

Redukcijos

EN 10253-3, ISO

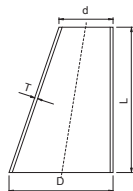
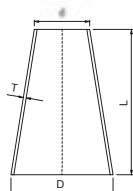

DN	DN1	D	d	T	5040 Koncentr. DIN2616		5041 Koncentr. L=D-dx3		5042 Ekscentrinės L=D-dx3	
					L	EN 1.4404	L	EN 1.4404	L	EN 1.4404
150	65	168,3	76,1	2,0			277	●	277	○
	80		88,9	2,0	140	○	238	●	238	○
100			114,3	3,0	140	○	238	●	238	○
				2,0	140	○	162	●	162	●
			3,0	140	○	162	●	162	●	
			2,0	140	○	86	●	86	●	
200	100	219,1	114,3	2,0	152	○	314	●	314	○
				3,0	152	○	314	●	314	○
125			139,7	2,0	152	○	238	●	238	●
				3,0	152	○	238	●	238	●
150			168,3	2,0	152	○	152	●	152	●
				3,0	152	○	152	●	152	●
250	125	273,0	139,7	2,0			398	●	398	○
				3,0			398	●	398	○
150			186,3	2,0	178	○	314	●	314	●
				3,0	178	○	314	●	314	●
200			219,1	2,0	178	○	162	●	162	●
				3,0	178	○	162	●	162	●
300	200	323,9	219,1	3,0	203	○	314	●	314	●
	250		273,0	3,0	203	○	153	●	153	●
350	250	355,6	273,0	3,0	203	○	247	●	147	○
	300		323,9	3,0	330	○	95	●	95	○
400	250	406,4	273,0	3,0	356	○	399	○	399	○
	300		323,9	3,0	356	○	248	●	248	○
350			355,6	3,0	356	○	304	○	304	○
				450	300	457,2	323,9	3,0		398
350			355,6	3,0			304	○	304	○
400			406,4	3,0			152	○	152	○
				500	300	508,0	323,9	3,0		550
350			355,6	3,0			455	○	455	○
400			406,4	3,0			304	○	304	○
				450	457,2	3,0		152	○	152
600	400	609,6	406,4	3,0			607	○	607	○
	450		457,2	3,0			455	○	455	○
500			508,0	3,0			304	○	304	○
				700	400	711,2	406,4	4,0		911
500			508,0	4,0			607	○	607	○
600	400	609,6	406,4	4,0			304	○	304	○
	600		609,6	4,0			607	○	607	○
800	500	812,8	508,0	4,0			911	○	911	○
	600		609,6	4,0			607	○	607	○
700	400	711,2	406,4	4,0			304	○	304	○
	600		609,6	4,0			911	○	911	○
900	600	914,4	609,6	5,0			607	○	607	○
	700		711,2	5,0			304	○	304	○
800	400	812,8	406,4	5,0			911	○	911	○
	600		609,6	5,0			607	○	607	○
1000	700	1016,0	711,2	5,0			304	○	304	○
	800		812,8	5,0			607	○	607	○
900			914,4	5,0			304	○	304	○

● = sandėliuojamos ○ = užsakomos pardavimai@busgeriau.lt +37066276762

02 Virinamos jungtys



Redukcijos

EN 10253-3, DIN / Metrinės

5046 Koncentrinės L=D-dx3
5047 Ekscentrinės L=D-dx3



DN	DN1	D	d	T	5046 Koncentrinės L=D-dx3	5047 Ekscentrinės L=D-dx3
					EN 1.4404 1.4432	EN 1.4404 1.4432
40	25	44	29	2.0	45 ●	45 ○
	32		36	2.0	24 ●	24 ○
50	25	54	29	2.0	75 ●	75 ○
	32		36	2.0	54 ●	54 ○
	40		44	2.0	30 ●	30 ●
65	40	69	44	2.0	75 ●	75 ○
	50		54	2.0	45 ●	45 ●
80	40	84	44	2.0	120 ●	120 ○
	50		54	2.0	90 ●	90 ●
	65		69	2.0	45 ●	45 ●
100	50	104	54	2.0	150 ●	150 ●
	65		70	2.0	105 ●	105 ●
	80		84	2.0	60 ●	60 ●
125	50	129	54	2.0	225 ●	225 ○
	65		69	2.0	179 ●	179 ○
	80		84	2.0	135 ●	135 ●
	100		104	2.0	75 ●	75 ●
150	80	154	84	2.0	210 ●	210 ○
	100		104	2.0	150 ●	150 ●
		156	106	3.0	150 ●	150 ●
	125	154	129	2.0	75 ●	75 ●
200	100	204	104	2.0	300 ●	300 ●
		206	106	3.0	300 ●	300 ○
	125	204	129	2.0	225 ●	225 ●
	150	204	154	2.0	150 ●	150 ●
		206	156	3.0	150 ●	150 ●
250	100	254	104	2.0	448 ●	448 ●
	125		129	2.0	375 ●	375 ●
	150		154	2.0	300 ●	300 ●
		256	156	3.0	300 ●	300 ○
	200	254	204	2.0	150 ●	150 ●
		256	206	3.0	150 ●	150 ●
300	200	304	204	2.0	300 ●	300 ●
		306	206	3.0	300 ●	300 ●
	250	304	254	2.0	150 ●	150 ●
		306	256	3.0	150 ●	150 ●
350	250	356	256	3.0	300 ●	300 ○
	300		306	3.0	150 ●	150 ●
400	300	406	306	3.0	300 ●	300 ●
	350		356	3.0	150 ●	150 ●
450	400	456	406	3.0	150 ●	150 ○
	500		506	3.0	300 ●	300 ●
		508	408	4.0	300 ○	300 ○
	450	506	456	3.0	150 ●	150 ○
		508	458	4.0	150 ○	150 ○

● = sandėliuojamos ○ = užsakomos

pardavimai@busgeriau.lt +37066276762

Tęsinys kitame psl

02 Virinamos jungtys



Redukcijos

EN 10253-3, DIN / Metrinės

5046
Koncentrinės
L=D-dx3

5047
Ekscentrinės
L=D-dx3

EN
L 1.4404
1.4432

EN
L 1.4404
1.4432

DN	DN1	D	d	T	L	EN	L	EN
600	400	606	406	3.0	600	●	600	○
		608	408	4.0	600	○	600	○
450	606	456	456	3.0	450	●	450	○
		608	458	4.0	450	○	450	○
500	606	506	506	3.0	300	●	300	○
		608	508	4.0	300	○	300	○
700	400	708	408	4.0	900	○	900	○
		500	508	4.0	600	○	600	○
600	500	608	608	4.0	300	○	300	○
		800	808	508	4.0	900	○	900
600	700	608	608	4.0	600	○	600	○
		708	708	4.0	300	○	300	○



02 Virinamos jungtys

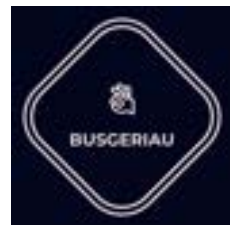

Dangtelis

DIN 28011 virinama aklė

ISO

DN	D x T	H	4050 5050	
			EN 1.43071.4404	EN
10	17,2 x 2,0	13	○	●
15	21,3 x 2,0	13	○	●
20	26,9 x 2,0	16	●	●
25	33,7 x 2,0	13	●	●
	33,7 x 3,0	13	○	●
32	42,4 x 2,0	17	●	●
40	48,3 x 2,0	20	●	●
	48,3 x 3,0	20	○	●
50	60,3 x 2,0	20	●	●
	3,0	20	○	●
65	76,1 x 2,0	26	●	●
	3,0	26	○	●
80	88,9 x 2,0	29	●	●
	3,0	31	○	●
100	114,3 x 2,0	28	●	●
	3,0	31	●	●
125	139,7 x 2,0	35	●	●
	3,0	36	●	●
150	168,3 x 2,0	49	●	●
	3,0	49	●	●
200	219,1 x 2,0	54	●	●
	3,0	54	●	●
250	273,0 x 2,0	65	●	●
	3,0	68	●	●
300	323,9 x 3,0	83	●	●
350	355,6 x 3,0	85	○	○
	355,6 x 4,0	85	○	○
400	406,4 x 3,0	100	○	○
	406,4 x 4,0	100	○	○
450	457,2 x 3,0	110	○	○
	457,2 x 4,0	110	○	○
500	508,0 x 3,0	120	○	○
	508,0 x 4,0	120	○	○
600	609,6 x 3,0	140	○	○
	609,6 x 4,0	140	○	○
700	711,2 x 4,0	152	○	○
	711,2 x 5,0	152	○	○

DIN / Metrinė

DN	D x T	H	4055 5055	
			EN 1.43071.4404	EN
20	25,0 x 2,0	12	○	●
25	30,0 x 2,0	13	○	●
32	38,0 x 2,0	19	○	●
40	44,5 x 2,0	15	○	●
	51,0 x 2,0	18	○	●
50	54,0 x 2,0	17	○	●
60	64,0 x 2,0	17	○	●
65	70,0 x 2,0	20	○	●
80	84,0 x 2,0	22	○	●
100	104,0 x 2,0	30	●	●
125	129,0 x 2,0	34	●	●
150	154,0 x 2,0	40	●	●
	156,0 x 3,0	40	○	●
200	204,0 x 2,0	47	●	●
	206,0 x 3,0	47	○	●
250	254,0 x 2,0	55	●	●
	256,0 x 3,0	66	●	●
300	304,0 x 2,0	66	●	●
	306,0 x 3,0	75	●	●
350	356,0 x 3,0	89	●	●
400	406,0 x 3,0	98	●	●
450	456,0 x 3,0	108	○	●
500	506,0 x 3,0	120	○	●
600	606,0 x 3,0	140	○	●
700	706,0 x 3,0	152	○	○

● = Sandėliuojama ○ = Užsakoma

02 Virinamos jungtys



Vamzdžių laikikliai

EN 1.4301, ISO / DIN / Metrinė

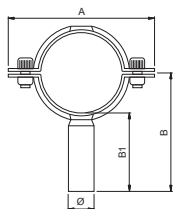

Be laikiklio
nr. 8800



Su trupu laikikliu
nr. 4060 / 4065



Su ilgu laikikliu
nr. 8700

Vamz diam. mm	A	Ø	B	B	B1	EN 1.4301	B	B1	EN 1.4301
8,0 - 9,0	60	8	●		50	●		150	●
10,0-11,0	60	8	●		50	●		150	●
12,0-13,5	62	8	●		50	●		150	●
15,0-16,0	65	8	●		50	●		150	●
17,0-18,0	68	8	●		50	●		150	●
19,0	68	8	●		50	●		150	●
21,3-23,0	72	8	●		90	●	150		●
25,0	78	21	●		90	●	150		●
26,9-29,0	80	21	●		90	●	150		●
30,0	80	21	●		90	●	150		○
32,0	85	21	●		90	●	150		●
33,7-34,0	87	21	●		90	●	150		●
35,0	88	21	●		90	●	150		●
38,0	91	21	●		90	●	150		●
40,0-41,0	94	21	●		90	●	150		●
42,4	96	21	●		90	●	150		●
48,3	101	21	●		90	●	150		●
51,0	104	21	●		90	●	150		●
52,0-53,0	107	21	●		90	●	150		●
54,0	107	21	●		90	●	150		○
60,3	113	21	●		90	●	150		●
63,5	116	21	●		90	●	150		●
70,0	123	21	●		90	●	150		●
76,1	129	21	●		90	●	150		●
84,0-85,0	137	21	●		90	●	150		●
88,9	143	21	●		90	●	150		●
101,6	155	21	●		90	●	150		●
104,0	157	21	●			●	150		●
114,3	167	21	●		40	●	150		●
129,0	182	21	●		40	●	150		○
139,7	193	21	●		40	●	150		○
154,0	207	21	●		40	●	150		○
168,3	221	21	●		40	●	150		○
204,0	257	21	●		40	●	150		○
219,1	272	21	●		40	●	150		○
254,0	307	21	●		40	●	150		○
304,0-306,0	359	21	●		40	●	150		○

● = Sandėliuojama ○ = Užsakoma pardavimai@busgeriau.lt +37066276762

02 Virinamos jungtys



Vamzdžių laikikliai iš juostos, Tipas SL

Busgeriau nr.	Be varžtų ir veržlių					4070	5070
DN	d1	a	c	d2	Juosta (b x s)	EN 1.4301	EN 1.4571
15 / 21,3	22	51	15	11,5	30 x 4	●	●
20 / 26,9	27	57	15	11,5	30 x 4	●	●
25 / 33,7	34	64	15	11,5	30 x 4	●	●
32 / 42,4	43	73	15	11,5	30 x 4	●	●
40 / 48,3	49	79	15	11,5	30 x 4	●	●
50 / 54,0	53	83	15	11,5	30 x 4	●	●
50 / 60,3	61	91	15	11,5	30 x 4	●	●
65 / 70,0	68	98	15	11,5	30 x 4	●	●
65 / 76,1	77	107	15	11,5	30 x 4	●	●
80 / 84,0	83	113	15	11,5	30 x 4	●	●
80 / 88,9	89	119	15	11,5	30 x 4	●	●
100 / 104,0	104	150	18	14	40 x 5	●	●
100 / 114,3	115	161	18	14	40 x 5	●	●
125 / 129,0	129	175	18	14	40 x 5	●	●
125 / 139,7	140	186	18	14	40 x 5	●	●
150 / 154,0	154	200	18	14	40 x 5	●	●
150 / 168,3	169	215	18	14	40 x 5	●	●
200 / 204,0	204	250	18	14	40 x 5	●	●
200 / 219,1	220	266	18	14	40 x 5	●	●
250 / 254,0	254	320	24	18	50 x 5	●	●
250 / 273,0	273	339	24	18	50 x 5	●	●
300 / 304,0	305	371	24	18	50 x 5	●	●
300 / 323,9	324	390	24	18	50 x 5	●	●
350 / 356,0	356	422	24	18	50 x 5	●	●
400 / 406-408	407	472	24	18	50 x 5	●	●
450 / 456-458	457	522	24	18	50 x 5	○	●
500 / 506-508	508	573	24	18	50 x 5	●	●
600 / 608-608	608	673	24	18	50 x 5	○	●

● = Sandėliuojama

○ = Užsakoma

pardavimai@busgeriau.lt +37066276762

02 Virinamos jungtys

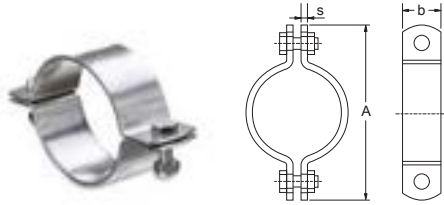

Vamzdžių laikikliai iš juostos, Tipas L

Busgeriau nr.

8850

8850-316

Su varžtais ir veržlėm

DN	Juosta (b x s)	A	EN 1.4301	EN 1.4404
12,0-13,0	20 x 2,5	62	●	●
17,0-18,0	20 x 2,5	72	●	●
19	20 x 2,5	72	●	●
21,3-23,0	35 x 2,5	72	●	●
25,0-25,4	35 x 2,5	76	●	●
26,9-29,0	35 x 2,5	79	●	●
32	35 x 2,5	83	●	●
33,7-34,0	35 x 2,5	85	●	●
35	35 x 2,5	85	●	●
38,0-38,1	35 x 2,5	90	●	●
40,0-41,0	35 x 2,5	92	●	●
42,4	35 x 2,5	94	●	●
48,3	35 x 2,5	103	●	●
50,8-51,0	35 x 2,5	103	●	●
52,0-53,0	35 x 2,5	103	●	●
60,3	35 x 2,5	115	●	●
63,5	35 x 2,5	116	●	●
70	35 x 2,5	122	●	●
76,1	35 x 2,5	128	●	●
85	35 x 2,5	137	●	●
88,9	35 x 2,5	148	●	●
101,6	35 x 2,5	154	●	●
104	35 x 2,5	154	●	●
114,3	35 x 2,5	173	●	●
129	35 x 2,5	182	●	●
154	35 x 2,5	207	●	●

● = Sandėliuojama ○ = Užsakoma pardavimai@busgeriau.lt +37066276762

03 Maistinės jungtys



03 Maistinės jungtys

Paviršius pagal EN 10357 / DIN 11850 ir tolerancijos pagal DIN 11852



DS/SMS alkūnė 90°

Busgeriau nr. 8000 9000 8000M 9000M
poliruotas poliruotas matinis matinis

Ø	T	R	A	AISI 304L	AISI 316L	AISI 304L	AISI 316L
25,0	1,2	25,0	55,0	●	●	○	○
32,0	1,2	32,0	64,0	○	●	○	○
38,0	1,2	38,0	70,0	●	●	○	○
51,0	1,2	51,0	82,0	●	●	○	○
63,5	1,6	63,5	105,0	●	●	○	○
76,1	2,0	76,0	110,0	●	●	○	○
101,6	2,0	110,0	150,0	●	●	○	○
101,6	2,0	150,0	150,0	●	●	○	○

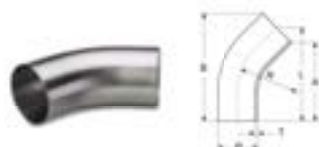

DS/SMS alkūnė 45°

Busgeriau nr. B045 9045 B045M 9045M
poliruotas poliruotas matinis matinis

Ø	T	R	A	B	L	AISI 304L	AISI 316L	AISI 304L	AISI 316L
25,0	1,2	25,0	68,1	85,8	77,0	●	●	○	○
32,0	1,2	32,0	79,7	102,3	91,0	○	●	○	○
38,0	1,2	38,0	83,5	110,4	97,0	●	●	○	○
51,0	1,2	51,0	89,9	126,0	108,0	●	●	○	○
63,5	1,6	63,5	115,6	160,5	138,0	●	●	○	○
76,1	2,0	76,0	113,2	166,9	140,0	●	●	○	○
101,6	2,0	150,0	150,0	221,9	186,0	●	●	○	○

● = Sandėliuojama ○ = Užsakoma pardavimai@busgeriau.lt +37066276762

03 Maistinės jungtys

Paviršius pagal to EN 10357 / DIN 11850 ir tolerancijos pagal DIN 11852



ISO alkūnė 90°, ilga

Busgeriau nr.

8100 9100 8100M 9100M
poliruota poliruota matinė matinė

Ø	T	R	A	L	AISI 304L AISI 316L AISI 304L AISI 316L			
					●	●	○	○
25,0	1,2	37,5	65,0	27,5	●	●	○	○
25,4	1,6	37,5	65,0	27,5	○	○	○	○
38,0	1,2	57,0	85,0	28,0	●	●	○	○
38,1	1,6	57,0	85,0	28,0	○	○	○	○
50,8	1,6	76,5	110,0	33,5	○	○	○	○
51,0	1,2	76,5	110,0	33,5	●	●	○	○
63,5	1,6	95,3	135,0	39,7	●	●	○	○
76,1	1,6	114,0	155,0	40,8	●	●	○	○
101,6	2,0	153,0	195,0	42,5	●	●	○	○

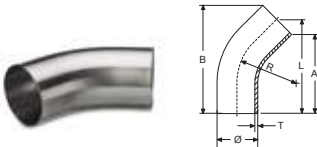

ISO alkūnė 45°

Busgeriau nr.

9145 9145M
poliruota matinė

Ø	T	R	A	B	L	AISI 316L AISI 316L	
						●	○
25,0	1,2	37,5	42,5	60,5	51,5	●	○
25,4	1,6	37,5	42,5	60,5	51,5	○	○
38,0	1,2	57,0	45,9	84,0	70,5	●	○
38,1	1,6	57,0	45,9	84,0	70,5	○	○
50,8	1,6	76,5	82,2	118,1	100,0	○	○
51,0	1,2	76,5	82,2	118,1	100,0	●	○
63,5	1,6	95,3	107,6	152,5	130,0	●	○
76,1	1,6	114,0	127,2	181,0	154,0	●	○
101,6	2,0	153,0	172,8	244,6	209,0	●	○

● = Sandėliuojama ○ = Užsakoma

pardavimai@busgeriau.lt +37066276762

03 Maistinės jungtys

Paviršius pagal EN 10357 / DIN 11850 ir tolerancijos pagal DIN 11852



ISO alkūnė 90°, trumpa

Busgeriau nr.

8250 9250 8250M 9250M

poliruota poliruota matinė matinė

Ø	T	R	A	AISI 304L AISI 316L AISI 304L AISI 316L			
				●	●	○	○
25,0	1,2	39,5	44,0	●	●	○	○
25,4	1,6	39,5	44,0	○	○	○	○
38,0	1,2	57,0	64,0	●	●	○	○
38,1	1,6	57,0	64,0	○	○	○	○
51,0	1,2	76,5	89,0	●	●	○	○
50,8	1,6	76,5	89,0	○	○	○	○
63,5	1,6	95,2	114,0	●	●	○	○
76,1	1,6	114,2	134,0	●	●	○	○
101,6	2,0	152,5	174,0	●	●	○	○



ISO alkūnė 90°, 3D

Busgeriau nr.

8910

poliruota

Ø	T	R	A	AISI 316L
				●
25,4	1,5	75,0	125,0	●
38,1	1,5	82,0	132,0	●
50,8	1,5	150,0	200,0	●
63,5	1,5	180,0	230,0	●
76,2	2,0	228,0	278,0	●

ISO alkūnė 90°itin trumpa

Busgeriau nr.

9200 9200M

poliruota matinė

Ø	T	R	A	AISI 316L AISI 316L	
				●	●
25,0	1,2	37,5	38,0	●	●
38,0	1,2	57,0	57,0	●	●
51,0	1,2	76,5	76,0	●	●
63,5	1,6	95,3	95,0	●	●
76,1	1,6	114,2	114,0	●	●
101,6	2,0	152,5	152,0	●	●

● = Sandėliuojama ○ = Užsakoma

pardavimai@busgeriau.lt +37066276762

03 Maistinės jungtys

Paviršius pagal EN 10357 / DIN 11850 ir tolerancijos pagal DIN 11852



DIN alkūnė 90°, ilga

Busgeriau nr.

8100 9100 8100M 9100M
poliruota poliruota matinė matinė

DN	Ø	T	R	A	L	AISI 304L	AISI 316L	AISI 304	AISI 316
10	13,0	1,5	26,0	38,0	12,0	○	●	○	○
15	19,0	1,5	35,0	47,0	12,0	○	●	○	○
20	23,0	1,5	40,0	52,0	12,0	○	●	○	○
25	29,0	1,5	50,0	70,0	20,0	○	●	○	○
32	35,0	1,5	55,0	80,0	23,0	○	●	○	○
40	41,0	1,5	60,0	85,0	25,0	○	●	○	○
50	53,0	1,5	70,0	97,0	27,0	○	●	○	○
65	70,0	2,0	80,0	110,0	30,0	○	●	○	○
80	85,0	2,0	90,0	118,0	28,0	○	●	○	○
100	104,0	2,0	100,0	140,0	40,0	○	●	○	○

Senas DIN spektras 1

10	12,0	1,5	26,0	38,0	12,0	○	○	○	○
15	18,0	1,5	35,0	47,0	12,0	○	●	○	○
20	22,0	1,5	40,0	52,0	12,0	○	●	○	○
25	28,0	1,5	50,0	70,0	20,0	○	●	○	○
32	34,0	1,5	55,0	78,0	23,0	○	○	○	○
40	40,0	1,5	60,0	85,0	25,0	○	●	○	○
50	52,0	1,5	70,0	97,0	27,0	○	●	○	○

● = Sandėliuojama ○ = Užsakoma

pardavimai@busgeriau.lt +37066276762

03 Maistinės jungtys

Paviršius pagal EN 10357 / DIN 11850 ir tolerancijos pagal DIN 11852

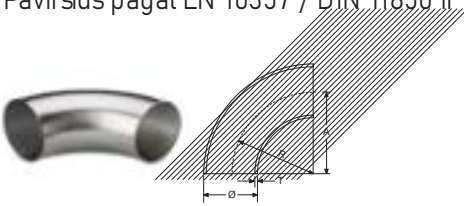

DIN alkūnė 90°, trumpa

Busgeriau nr.

8200 9200 8200M 9200M
poliruota poliruota matinė matinė

DN	Ø	T	R	A	AISI 304L	AISI 316L	AISI 304L	AISI 316L
10	13,0	1,5	26,0	26,0	○	●	○	○
15	19,0	1,5	35,0	35,0	○	●	○	○
20	23,0	1,5	40,0	40,0	○	●	○	○
25	29,0	1,5	50,0	50,0	○	●	○	○
32	35,0	1,5	55,0	55,0	○	●	○	○
40	41,0	1,5	60,0	60,0	○	●	○	○
50	53,0	1,5	70,0	70,0	○	●	○	○
65	70,0	2,0	80,0	80,0	○	●	○	○
80	85,0	2,0	90,0	90,0	○	●	○	○
100	104,0	2,0	100,0	100,0	○	●	○	○
125	129,0	2,0	187,5	187,5	○	●	○	●
150	154,0	2,0	225,0	225,0	○	●	○	●
200	204,0	2,0	300,0	300,0	○	●	○	●

Senas DIN spektras 1

10	12,0	1,5	26,0	26,0	○	●	○	○
15	18,0	1,5	35,0	35,0	○	●	○	○
20	22,0	1,5	40,0	40,0	○	●	○	○
25	28,0	1,5	50,0	50,0	○	●	○	○
32	34,0	1,5	55,0	55,0	○	●	○	○
40	40,0	1,5	60,0	60,0	○	●	○	○
50	52,0	1,5	70,0	70,0	○	●	○	○

● = Sandėliuojama ○ = Užsakoma pardavimai@busgeriau.lt +37066276762

03 Maistinės jungtys

Paviršius pagal EN 10357 / DIN 11850 ir tolerancijos pagal DIN 11852

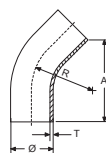
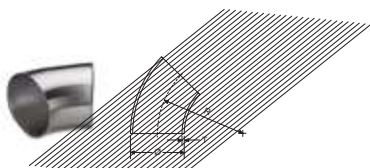

DIN alkūnė 45°, trumpa DIN alkūnė 45°, ilga

Busgeriau nr.

9145 9145M

Busgeriau nr.

9145L

poliruota matinė

poliruota

DN	Ø	T	R	AISI 304L	AISI 316L	DN	Ø	T	R	A	AISI 316L
10	13,0	1,5	26,0	●	○	10	13,0	1,5	26,0	35,8	●
15	19,0	1,5	35,0	●	○	15	19,0	1,5	35,0	39,5	●
20	23,0	1,5	40,0	●	○	20	23,0	1,5	40,0	41,6	●
25	29,0	1,5	50,0	●	○	25	29,0	1,5	50,0	60,7	●
32	35,0	1,5	55,0	●	○	32	35,0	1,5	55,0	62,8	●
40	41,0	1,5	60,0	●	○	40	41,0	1,5	60,0	64,9	●
50	53,0	1,5	70,0	●	○	50	53,0	1,5	70,0	69,0	●
65	70,0	2,0	80,0	●	○	65	70,0	2,0	80,0	73,1	●
80	85,0	2,0	90,0	●	○	80	85,0	2,0	90,0	92,3	●
100	104,0	2,0	100,0	●	○	100	104,0	2,0	100,0	96,4	●
125	129,0	2,0	187,5	●	○	125	129,0	2,0	187,5	160,2	●
150	154,0	2,0	225,0	●	○	150	154,0	2,0	225,0	193,2	●
200	204,0	2,0	300,0	●	○						

Old DIN range 1

10	12,0	1,5	26,0	●	○
15	18,0	1,5	35,0	●	○
20	22,0	1,5	40,0	●	○
25	28,0	1,5	50,0	●	○
32	34,0	1,5	55,0	○	○
40	40,0	1,5	60,0	●	○
50	52,0	1,5	70,0	●	○

● = Sandėliuojama ○ = Užsakoma

pardavimai@busgeriau.lt +37066276762

03 Maistinės jungtys

Paviršius pagal EN 10357 / DIN 11850 ir tolerancijos pagal DIN 11852



DS/SMS Trišakis, trumpas

Busgeriau nr. 8400 9400 8400M 9400M
 poliruotas poliruotas matinis matinis

Ø mm	T mm	A mm	B mm	AISI 304L	AISI 316L	AISI 304L	AISI316L
25,0	1,2	55,0	14,0	●	●	○	○
32,0	1,2	64,0	18,0	○	○	○	○
38,0	1,2	70,0	22,0	●	●	○	○
51,0	1,2	82,0	29,0	●	●	○	○
63,5	1,6	105,0	35,0	●	●	○	○
76,1	2,0	110,0	41,0	●	●	○	○
101,6	2,0	150,0	55,0	●	●	○	○



DS/SMS Trišakis, lygus

Busgeriau nr. 8300 9300 8300M 9300M
 poliruotas poliruotas matinis matinis

Ø mm	T mm	A mm	B mm	AISI 304L	AISI 316L	AISI 304L	AISI316L
25,0	1,2	55,0	55,0	●	●	○	○
32,0	1,2	64,0	64,0	○	●	○	○
38,0	1,2	70,0	70,0	●	●	○	○
51,0	1,2	82,0	82,0	●	●	○	○
63,5	1,6	105,0	105,0	●	●	○	○
76,1	2,0	110,0	110,0	●	●	○	○
101,6	2,0	150,0	150,0	●	●	○	○

● = Sandėliuojama ○ = Užsakoma pardavimai@busgeriau.lt +37066276762

03 Maistinės jungtys

Paviršius pagal EN 10357 / DIN 11850 ir tolerancijos pagal DIN 11852

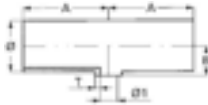

DS/SMS Trišakis, trumpas, redukcinis

Busgeriau nr.

9450 9450M

poliruotas matinis

Nom. srg.	Ø	Ø1	T	A	B	AISI 316L	AISI 316L
38,0 / 25,0	38,0	22,6	1,2	70,0	22,0	●	○
51,0 / 25,0	51,0	22,6	1,2	82,0	29,0	●	○
51,0 / 38,0	51,0	35,6	1,2	82,0	29,0	●	○
63,5 / 25,0	63,5	22,6	1,6	105,0	35,0	●	○
63,5 / 38,0	63,5	35,6	1,6	105,0	35,0	●	○
63,5 / 51,0	63,5	48,6	1,6	105,0	35,0	●	○
76,0 / 25,0	76,1	22,6	2,0	110,0	41,0	●	○
76,0 / 38,0	76,1	35,6	2,0	110,0	41,0	●	○
76,0 / 51,0	76,1	48,6	2,0	110,0	41,0	●	○
76,0 / 63,5	76,1	60,5	2,0	110,0	41,0	●	○
101,6 / 25,0	101,6	22,6	2,0	150,0	55,0	●	○
101,6 / 38,0	101,6	35,6	2,0	150,0	55,0	●	○
101,6 / 51,0	101,6	48,6	2,0	150,0	55,0	●	○
101,6 / 63,5	101,6	60,5	2,0	150,0	55,0	●	○
101,6 / 76,0	101,6	72,0	2,0	150,0	55,0	●	○

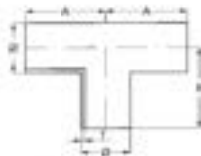

ISO Trišakis, lygus

Busgeriau nr.

9500 9500M

poliruotas matinis

Ø mm	T mm	A mm	B mm	AISI 316L	AISI 316L
25,0	1,2	44,0	44,0	●	○
38,0	1,2	64,0	64,0	●	○
51,0	1,2	89,0	89,0	●	○
63,5	1,6	114,0	114,0	●	○
76,1	1,6	134,0	134,0	●	○
101,6	2,0	174,0	174,0	●	○

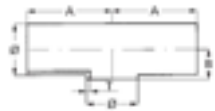

ISO Trišakis, trumpas

Busgeriau nr.

9600 9600M

poliruotas matinis

Ø mm	T mm	A mm	B mm	AISI 316L	AISI 316L
25,0	1,2	44,0	14,0	●	○
38,0	1,2	64,0	22,0	●	○
51,0	1,2	89,0	29,0	●	○
63,5	1,6	114,0	35,0	●	○
76,1	1,6	134,0	41,0	●	○
101,6	2,0	174,0	55,0	●	○

● = Sandėliuojama

○ = Užsakoma

pardavimai@busgeriau.lt +37066276762

03 Maistinės jungtys

Paviršius pagal EN 10357 / DIN 11850 ir tolerancijos pagal DIN 11852

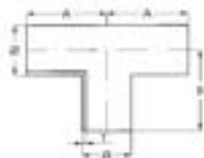

DIN Trišakis, lygus

Busgeriau nr.

9500 9500M
poliruotas matinis

DN	Ø	T	A	B	AISI 316L	AISI 316L
10	13,0	1,5	26,0	26,0	●	○
15	19,0	1,5	35,0	35,0	●	○
20	23,0	1,5	40,0	40,0	●	○
25	29,0	1,5	50,0	50,0	●	○
32	35,0	1,5	55,0	55,0	●	○
40	41,0	1,5	60,0	60,0	●	○
50	53,0	1,5	70,0	70,0	●	○
65	70,0	2,0	80,0	80,0	●	○
80	85,0	2,0	90,0	90,0	●	○
100	104,0	2,0	100,0	100,0	●	○
125	129,0	2,0	188,0	188,0	○	○
150	154,0	2,0	225,0	225,0	○	○

Senas DIN spektras 1

10	12,0	1,5	26,0	26,0	●	○
15	18,0	1,5	35,0	35,0	○	○
20	22,0	1,5	40,0	40,0	○	○
25	28,0	1,5	50,0	50,0	○	○
32	34,0	1,5	55,0	55,0	○	○
40	40,0	1,5	60,0	60,0	○	○
50	52,0	1,5	70,0	70,0	○	○

03 Maistinės jungtys

Paviršius pagal EN 10357 / DIN 11850 ir tolerancijos pagal DIN 11852

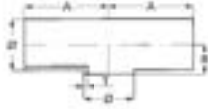

DIN Trišakis, trumpas

Busgeriau nr.

9600 9600M
poliruotas matinis

DN	Ø	T	A	B	AISI 316	AISI 316L
15	19,0	1,5	35,0	11,0	●	○
20	23,0	1,5	40,0	12,0	●	○
25	29,0	1,5	50,0	16,0	●	○
32	35,0	1,5	55,0	19,0	●	○
40	41,0	1,5	60,0	22,0	●	○
50	53,0	1,5	70,0	29,5	●	○
65	70,0	2,0	80,0	40,0	●	○
80	85,0	2,0	90,0	45,5	●	○
100	104,0	2,0	100,0	58,0	●	○
125	129,0	2,0	188,0	72,0	●	○
150	154,0	2,0	225,0	87,0	●	○
200	204,0	2,0	300,0	115,0	●	○

Senas DIN spektras 1

15	18,0	1,5	35,0	11,5	●	○
20	22,0	1,5	40,0	14,5	●	○
25	28,0	1,5	50,0	16,0	●	○
32	34,0	1,5	55,0	19,0	●	○
40	40,0	1,5	60,0	22,0	●	○
50	52,0	1,5	70,0	29,5	●	○

03 Maistinės jungtys

Paviršius pagal EN 10357 / DIN 11850 ir tolerancijos pagal DIN 11852



DIN Trišakis, trumpas, redukcinis

Busgeriau nr.

9650 9650M

poliruotas matinis

DN	Ø	Ø1	T	A	B	AISI 316L	AISI 316L
25 / 15	29,0	19,0	1,5	50,0	16,0	●	○
25 / 20	29,0	23,0	1,5	50,0	16,0	●	○
32 / 25	35,0	29,0	1,5	55,0	19,0	●	○
40 / 15	41,0	19,0	1,5	60,0	22,0	●	○
40 / 20	41,0	23,0	1,5	60,0	22,0	●	○
40 / 25	41,0	29,0	1,5	60,0	22,0	●	○
40 / 32	41,0	35,0	1,5	60,0	22,0	●	○
50 / 15	53,0	19,0	1,5	70,0	29,5	●	○
50 / 25	53,0	29,0	1,5	70,0	29,5	●	○
50 / 32	53,0	35,0	1,5	70,0	29,5	●	○
50 / 40	53,0	41,0	1,5	70,0	29,5	●	○
65 / 25	70,0	29,0	2,0 / 1,5	80,0	40,0	●	○
65 / 40	70,0	41,0	2,0 / 1,5	80,0	40,0	●	○
65 / 50	70,0	53,0	2,0 / 1,5	80,0	40,0	●	○
80 / 40	85,0	41,0	2,0 / 1,5	90,0	45,5	●	○
80 / 50	85,0	53,0	2,0 / 1,5	90,0	45,5	●	○
80 / 65	85,0	70,0	2,0	90,0	45,5	●	○
100 / 25	104,0	29,0	2,0 / 1,5	100,0	58,0	●	○
100 / 40	104,0	41,0	2,0 / 1,5	100,0	58,0	●	○
100 / 50	104,0	53,0	2,0 / 1,5	100,0	58,0	●	○
100 / 65	104,0	70,0	2,0	100,0	58,0	●	○
100 / 70	104,0	85,0	2,0	100,0	58,0	●	○
125 / 65	129,0	70,0	2,0	188,0	74,0	●	○
125 / 80	129,0	85,0	2,0	188,0	74,0	●	○
125 / 100	129,0	104,0	2,0	188,0	74,0	●	○
150 / 80	154,0	85,0	2,0	225,0	90,0	●	○
150 / 100	154,0	104,0	2,0	225,0	90,0	●	○
150 / 125	154,0	129,0	2,0	225,0	90,0	●	○
200 / 150	204,0	154,0	2,0	300,0	115,0	●	○

● = Sandėliuojama ○ = Užsakoma pardavimai@busgeriau.lt +37066276762

03 Maistinės jungtys

Paviršius pagal EN 10357 / DIN 11850 ir tolerancijos pagal DIN 11852



DS/SMS/ISO X

Busgeriau nr. 8940 8940M
poliruotas matinis

Ø	T	A	B	AISI 316L	AISI 316L
25,0	1,2	44,0	14,0	●	○
38,0	1,2	64,0	22,0	●	○
51,0	1,2	89,0	29,0	●	○
63,5	1,6	114,0	35,0	●	○
76,1	1,6	134,0	41,0	●	○
101,6	2,0	174,0	55,0	●	○



DIN X

Busgeriau nr. 8940 8940M
poliruotas matinis

DN	Ø	T	A	B	AISI 316L	AISI 316L
15	19,0	1,5	35,0	11,0	○	○
20	23,0	1,5	40,0	13,5	○	○
25	29,0	1,5	50,0	16,5	○	○
32	35,0	1,5	55,0	19,0	○	○
40	41,0	1,5	60,0	22,5	○	○
50	53,0	1,5	70,0	29,5	○	○
65	70,0	2,0	80,0	40,0	○	○
80	85,0	2,0	90,0	45,5	○	○
100	104,0	2,0	100,0	58,0	○	○
125	129,0	2,0	117,5	71,5	○	○
150	154,0	2,0	125,0	87,0	○	○

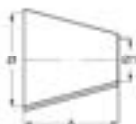

DS/SMS Redukcija, conc.

Busgeriau nr. 9700 9700M
poliruotas matinis

srg. nuo / iki	Ø	Ø1	A	AISI 316L	AISI 316L
25,0 / 12,0	22,6	10,0	35,4	●	○
25,0 / 18,0	22,6	15,6	19,8	●	○
25,0 / 19,0	22,6	16,6	25,0	●	○
38,0 / 25,0	35,6	22,6	39,0	●	○
51,0 / 25,0	48,6	22,6	77,4	●	○
51,0 / 38,0	48,6	35,6	40,5	●	○
63,5 / 38,0	60,5	35,6	76,4	●	○
63,5 / 51,0	60,5	48,6	37,4	●	○
76,0 / 38,0	72,0	35,6	68,8	●	○
76,0 / 51,0	72,0	48,6	72,0	●	○
76,0 / 63,5	72,0	60,5	35,7	●	○
101,6 / 51,0	97,6	48,6	94,7	●	○
101,6 / 63,5	97,6	60,5	105,2	●	○
101,6 / 76,0	97,6	72,0	77,6	●	○



DS/SMS Redukcija exc.

Busgeriau nr. 9750 9750M
poliruotas matinis

srg. nuo / iki	Ø	Ø1	A	AISI 316L	AISI 316L
38,0 / 25,0	35,6	22,6	37,9	●	○
51,0 / 25,0	48,6	22,6	75,5	●	○
51,0 / 38,0	48,6	35,6	39,6	●	○
63,5 / 38,0	60,5	35,6	71,0	●	○
63,5 / 51,0	60,5	48,6	36,3	●	○
76,0 / 51,0	72,0	48,6	70,2	●	○
76,0 / 63,5	72,0	60,5	35,8	●	○
101,6 / 63,5	97,6	60,5	101,8	●	○
101,6 / 76,0	97,6	72,0	76,1	●	○

● = Sandėliuojama ○ = Užsakoma

pardavimai@busgeriau.lt +37066276762

03 Maistinės jungtys



Paviršius pagal EN 10357 / DIN 11850 ir tolerancijos pagal DIN 11852

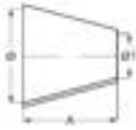

DIN-DS/SMS redukcija, koncentrinė

Busgeriau nr.

9700 9700M
poliruotas matinis

srg. nuo / iki	Ø	Ø1	A	AISI 316L	AISI 316L
104,0 / 51,0	100,0	48,6	95,0	●	○
104,0 / 63,5	100,0	60,5	78,0	●	○
104,0 / 76,1	100,0	72,1	60,0	●	○
129,0 / 76,1	125,0	72,1	101,0	●	○
129,0 / 101,6	125,0	97,6	54,8	●	○
154,0 / 101,6	150,0	97,6	101,0	●	○

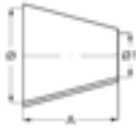

DIN redukcija, koncentrinė

Busgeriau nr.

9800 9800M
poliruotas matinis

DN	srg. from / to	Ø	Ø1	A	AISI 316L	AISI 316L
15 / 10	19,0 / 13,0	15,0	10,0	11,0	●	○
20 / 10	23,0 / 13,0	20,0	10,0	18,0	●	○
20 / 15	23,0 / 19,0	20,0	15,0	7,0	●	○
25 / 10	29,0 / 13,0	25,0	10,0	30,0	●	○
25 / 15	29,0 / 19,0	25,0	15,0	18,0	●	○
25 / 20	29,0 / 23,0	25,0	20,0	11,0	●	○
32 / 15	35,0 / 19,0	32,0	15,0	31,0	●	○
32 / 20	35,0 / 23,0	32,0	20,0	22,0	●	○
32 / 25	35,0 / 29,0	32,0	25,0	11,0	●	○
40 / 15	41,0 / 19,0	38,0	15,0	41,0	●	○
40 / 20	41,0 / 23,0	38,0	20,0	33,0	●	○
40 / 25	41,0 / 29,0	38,0	25,0	22,0	●	○
40 / 32	41,0 / 35,0	38,0	32,0	11,0	●	○
50 / 15	53,0 / 19,0	50,0	15,0	63,0	●	○
50 / 25	53,0 / 29,0	50,0	25,0	56,0	●	○
50 / 32	53,0 / 35,0	50,0	32,0	33,0	●	○
50 / 40	53,0 / 41,0	50,0	38,0	22,0	●	○
65 / 25	70,0 / 29,0	66,0	25,0	75,0	●	○
65 / 32	70,0 / 35,0	66,0	32,0	64,0	●	○
65 / 40	70,0 / 41,0	66,0	38,0	51,0	●	○
65 / 50	70,0 / 53,0	66,0	50,0	29,0	●	○
80 / 40	85,0 / 41,0	81,0	38,0	80,0	●	○
80 / 50	85,0 / 53,0	81,0	50,0	56,0	●	○
80 / 65	85,0 / 70,0	81,0	66,0	27,0	●	○
100 / 50	104,0 / 53,0	100,0	50,0	93,0	●	○
100 / 65	104,0 / 70,0	100,0	66,0	61,0	●	○
100 / 80	104,0 / 85,0	100,0	81,0	34,0	●	○
125 / 80	129,0 / 85,0	125,0	81,0	79,0	●	○
125 / 100	129,0 / 104,0	125,0	100,0	45,0	●	○
150 / 100	154,0 / 104,0	151,0	100,0	90,0	●	○
154 / 125	154,0 / 129,0	151,0	125,0	45,0	●	○
200 / 150	204,0 / 154,0	200,0	150,0	90,0	●	○

● = Sandėliuojama ○ = Užsakoma

pardavimai@busgeriau.lt +37066276762

03 Maistinės jungtys

Paviršius pagal EN 10357 / DIN 11850 ir tolerancijos pagal DIN 11852

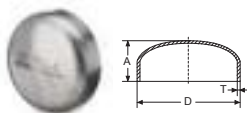
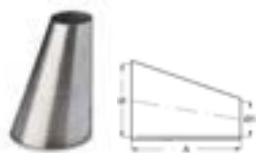

DIN redukcija, ekscentrinė

Busgeriau nr..

9850 9850M
poliruotas matinis

Dangtelis

Busgeriau nr.

9840
poliruotas

DN	srg. nuo / iki	Ø	Ø1	A	AISI 316L	AISI 316L
15 / 10	19,0 / 13,0	15,0	10,0	16,5	●	○
20 / 15	23,0 / 19,0	20,0	15,0	11,0	●	○
25 / 10	29,0 / 13,0	25,0	10,0	44,0	●	○
25 / 15	29,0 / 19,0	25,0	15,0	27,5	●	○
25 / 20	29,0 / 23,0	25,0	20,0	16,5	●	○
32 / 20	35,0 / 23,0	32,0	20,0	33,0	●	○
32 / 25	35,0 / 29,0	32,0	25,0	16,5	●	○
40 / 15	41,0 / 19,0	38,0	15,0	60,5	●	○
40 / 20	41,0 / 23,0	38,0	20,0	49,5	●	○
40 / 25	41,0 / 29,0	38,0	25,0	33,0	●	○
40 / 32	41,0 / 35,0	38,0	32,0	16,5	●	○
50 / 25	53,0 / 29,0	50,0	25,0	66,0	●	○
50 / 32	53,0 / 35,0	50,0	32,0	49,5	●	○
50 / 40	53,0 / 41,0	50,0	38,0	33,0	●	○
65 / 40	70,0 / 41,0	66,0	38,0	77,0	●	○
65 / 50	70,0 / 53,0	66,0	50,0	44,0	●	○
80 / 50	85,0 / 53,0	81,0	50,0	85,0	●	○
80 / 65	85,0 / 70,0	81,0	66,0	41,0	●	○
100 / 65	104,0 / 70,0	100,0	66,0	93,5	●	○
100 / 80	104,0 / 85,0	100,0	81,0	52,5	●	○
125 / 80	129,0 / 85,0	125,0	81,0	121,0	●	○
125 / 100	129,0 / 104,0	125,0	100,0	68,5	●	○
150 / 100	154,0 / 104,0	151,0	100,0	137,5	●	○
154 / 125	154,0 / 129,0	151,0	125,0	68,5	●	○
200 / 150	204,0 / 154,0	200,0	150,0	125,0	○	○

Vam srg. T mm	A mm	EN	
19,0	1,5	12,0	●
25,0	1,5	12,0	●
29,0	1,5	12,0	●
38,0	1,5	15,0	●
41,0	1,5	14,0	●
51,0	1,5	19,0	●
53,0	1,5	19,0	●
63,5	1,6	19,0	●
63,5	2,0	19,0	●
70,0	2,0	21,0	●
76,1	2,0	27,0	●
85,0	2,0	21,0	●
101,6	2,0	24,0	●
104,0	2,0	24,0	●
129,0	2,0	34,0	●
154,0	2,0	41,0	●
204,0	2,0	50,0	●

● = Sandėliuojama ○ = Užsakoma

pardavimai@busgeriau.lt +37066276762

03 Maistinės jungtys

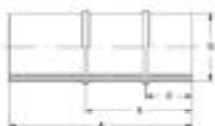

Žarnos atvamzdis

Busgeriau nr. 9830

Nom. srg.	A	B	C	D	AISI 316L
25,0	60,0	35,0	15,0	25,4	•
38,0	80,0	45,0	20,0	36,1	•
51,0	90,0	45,0	20,0	50,8	•
63,5	100,0	50,0	25,0	63,5	•
76,0	110,0	55,0	25,0	76,1	•
101,6	120,0	65,0	26,0	101,6	•



Peteliškė sklendė

su virinamais galais, EPDM-tarpine

Busgeriau nr. 9880

ISO

Ø	A	B	C	D	AISI 316L
25,4	40,0	87,0	89,0	122,0	•
38,1	50,0	97,0	94,0	122,0	•
50,8	50,0	110,0	100,0	122,0	•
63,5	50,0	127,0	109,0	150,0	•
76,1	60,0	142,0	116,0	150,0	•
101,6	64,0	162,0	127,0	150,0	•

DIN

19,0	40,0	87,0	89,0	122,0	•
23,0	40,0	87,0	89,0	122,0	•
29,0	40,0	87,0	89,0	122,0	•
35,0	42,0	92,0	91,0	122,0	•
41,0	50,0	97,0	94,0	122,0	•
53,0	50,0	110,0	100,0	150,0	•
70,0	50,0	127,0	109,0	150,0	•
85,0	60,0	142,0	116,0	150,0	•
104,0	64,0	162,0	127,0	150,0	•
129,0	86,0	202,0	155,0	216,0	•
154,0	90,0	231,0	170,0	216,0	•

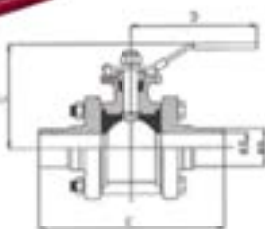

DS/SMS Rutulinė

Su virinamais galais, Teflono tarpinė

Busgeriau nr. 9890

Nom. srg.	A	B	C	D	E	AISI 316L
25,0	25,0	22,6	62,0	132,0	115,2	•
38,0	38,0	35,6	98,0	175,0	139,9	•
51,0	51,0	48,6	103,9	175,0	158,1	•
63,0	63,5	60,3	141,0	260,0	198,2	•
76,0	76,1	72,9	154,9	260,0	227,5	•
101,6	101,6	97,6	175,0	260,0	242,0	•

Kitos modifikacijos ir priedai gali būti pateikti per kelias dienas

Peteliškė sklendė:

- su užspaudžiamais galais
- su DIN srieginėm jungtim
- su DIN veržlėm
- kombinuotos: DIN sriegis / virinama
- kombinuotos: DIN sriegis / veržlė

Priedai:

- Rankenos (standartinės, reguliuojamos ir kt.
- Vožtuvo diskai
- Tarpinės (slūšonas), EPDM, FKM (Viton) ir H-NBR

• = Sandėliuojama ○ = Užsakoma

03 Maistinės jungtys

DS/SMS/ISO vamzdžių laikikliai

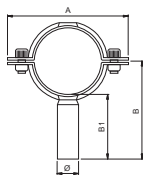

Busgeriau nr.



8700
Ilgas laikiklis



8750
Trumpas laikiklis



8800
Be laikiklio



8810
Su 1/2" vid. srieg.

Vam.diam. A			Ø	B	AISI 304	B	AISI 304	AISI 304	AISI 304
25,0	78,0	21,3	150	•	90	•	•	•	
32,0	85,0	21,3	150	•	90	•	•	•	
38,0	91,0	21,3	150	•	90	•	•	•	
51,0	104,0	21,3	150	•	90	•	•	•	
63,5	116,0	21,3	150	•	90	•	•	•	
76,1	129,0	21,3	150	•	90	•	•	•	
101,6	155,0	21,3	150	•	90	•	•	•	

DIN vamzdžių laikikliai

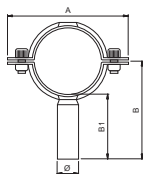

Busgeriau nr.



8700
Ilgas laikiklis



4065
Trumpas laikiklis



8800
Be laikiklio

Vam.diam. A			Ø	B	B1	AISI 304	B	B1	AISI 304	AISI 304
13,0	62,0	8,0		150	•	50	•	•		
19,0	68,0	8,0		150	•	50	•	•		
23,0	72,0	21,3	150	•	90	•	•	•		
29,0	80,0	21,3	150	•	90	•	•	•		
35,0	88,0	21,3	150	•	90	•	•	•		
41,0	94,0	21,3	150	•	90	•	•	•		
53,0	107,0	21,3	150	•	90	•	•	•		
70,0	123,0	21,3	150	•	90	•	•	•		
84,0	137,0	21,3	150	•	90	•	•	•		
104,0	157,0	21,3	150	•	90	•	•	•		
129,0	182,0	21,3	150	•	40	•	•	•		
154,0	207,0	21,3	150	•	40	•	•	•		
204,0	257,0	21,3	150	•	40	•	•	•		

• = Sandėliuoja

○ = Užsakoma

pardavimai@busgeriau.lt +37066276762

03 Maistinės jungtys

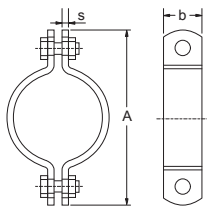

Vamzdžio laikiklis iš juostos, Tipas L

Busgeriaus nr.

8850

8850-316

Su varžtais ir veržlėm

DN	juosta (b x s)	A	EN 1.4301	EN 1.4404
12,0-13,0	20 x 2,5	62	•	•
17,0-18,0	20 x 2,5	72	•	•
19	20 x 2,5	72	•	•
21,3-23,0	35 x 2,5	72	•	•
25,0-25,4	35 x 2,5	76	•	•
26,9-29,0	35 x 2,5	79	•	•
32	35 x 2,5	83	•	•
33,7-34,0	35 x 2,5	85	•	•
35	35 x 2,5	85	•	•
38,0-38,1	35 x 2,5	90	•	•
40,0-41,0	35 x 2,5	92	•	•
42,4	35 x 2,5	94	•	•
48,3	35 x 2,5	103	•	•
50,8-51,0	35 x 2,5	103	•	•
52,0-53,0	35 x 2,5	103	•	•
60,3	35 x 2,5	115	•	•
63,5	35 x 2,5	116	•	•
70	35 x 2,5	122	•	•
76,1	35 x 2,5	128	•	•
85	35 x 2,5	137	•	•
88,9	35 x 2,5	148	•	•
101,6	35 x 2,5	154	•	•
104	35 x 2,5	154	•	•
114,3	35 x 2,5	173	•	•
129	35 x 2,5	182	•	•
154	35 x 2,5	207	•	•

• = Sandėliuojama

○ = Užsakoma

pardavimai@busgeriau.lt +37066276762

03 Maistinės jungtys

Flanšai

AINI 316L / EN 1.4404, EN1092-1

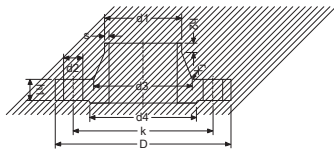

DS/SMS virinami flanšai su kakliuku Tipas 11B

Busgeriau nr.

Nom. srg.	d1	Flanšai				Kakliukas				Tarpinė		Varžtai		Thr. M. d2	
		Slėgis	D	b	k	h1	d3	s	r	h2	d4	f	vnt.		
DN 20	25,0	PN 10/16/25/40	105	18	75	40	40	1,5	4	6	58 2	4	12	14	6035
DN 32	38,0	PN 10/16/25/40	140	18	100	42	56	1,5	6	6	78 2	4	16	18	6035
DN 50	51,0	PN 10/16	165	18	125	45	74	1,5	6	8	102 3	4	16	18	6030
DN 65	63,5	PN 10/16	185	18	145	45	92	2,0	6	10	122 3	4	16	18	6030
DN 65	76,1	PN 10/16	185	18	145	45	92	2,0	6	10	122 3	8	16	18	6030
DN 100	101,6	PN 10/16	220	20	180	52	131	2,0	8	12	158 3	8	16	18	6030

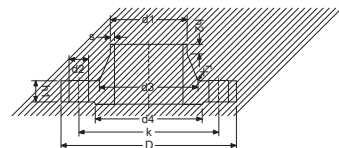

DIN virinami flanšai su kakliuku Tipas 11B

Busgeriau nr.

Nom. srg.	d1	Flanšai				Kakliukas				Tarpinė		Varžtai		Thr. M. d2	
		Slėgis	D	b	k	h1	d3	s	r	h2	d4	f	vnt.		
DN 10	13,0	PN 10/16/25/40	90	16	60	35	28	1,5	4	6	40 2	4	12	14	6035
DN 15	19,0	PN 10/16/25/40	95	16	65	38	32	1,5	4	6	45 2	4	12	14	6035
DN 20	23,0	PN 10/16/25/40	105	18	75	40	40	1,5	4	6	58 2	4	12	14	6035
DN 25	29,0	PN 10/16/25/40	115	18	85	40	46	1,5	4	6	68 2	4	12	14	6035
DN 32	35,0	PN 10/16/25/40	140	18	100	42	56	1,5	6	6	78 2	4	16	18	6035
DN 40	41,0	PN 10/16/25/40	150	18	100	45	64	1,5	6	7	88 3	4	16	18	6035
DN 50	53,0	PN 10/16	165	18	125	45	74	1,5	6	8	102 3	4	16	18	6030
DN 65 - 4h	70,0	PN 10/16	185	18	145	45	92	2,0	6	10	122 3	4	16	18	6030
DN 65 - 8h	70,0	PN 10/16	185	18	145	45	92	2,0	6	10	122 3	8	16	18	6030
DN 80	85,0	PN 10/16	200	20	160	50	105	2,0	8	10	138 3	8	16	18	6030
DN 100	104,0	PN 10/16	220	20	180	52	131	2,0	8	12	158 3	8	16	18	6030
DN 125	129,0	PN 10/16	250	22	210	55	156	2,0	8	12	188 3	8	16	18	6030
DN 150	154,0	PN 10/16	285	22	240	55	184	2,0	10	12	212 3	8	20	22	6030
DN 200	204,0	PN 10	340	24	295	62	234	2,0	10	16	268 3	8	20	22	6029

03 Maistinės jungtys

Flanšai

AINI 316L / EN 1.4404, EN1092-1

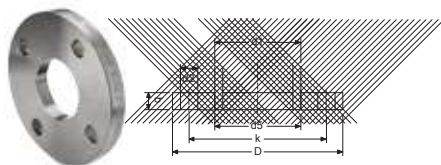

DS/SMS plokšti virinami flanšai Tipas 01A

Nom. srg.	d1	Slėgis	Flanšai				Varžtai			Busgeriau nr.
			d5	D	b	k	vnt.	Sriegis M.	d2	
DN 20	25,0	PN10/16/25/40	26,0	105	16	75	4	M12	14	6025
DN 32	38,0	PN10/16/25/40	39,0	140	18	100	4	M16	18	6025
DN 50	51,0	PN 10/16	52,0	165	20	125	4	M16	18	6025
DN 65	63,5	PN 10/16	64,5	185	20	145	4	M16	18	6025
DN 65 - 4h	76,1	PN 10/16	77,5	185	20	145	4	M16	18	6020
DN 65	76,1	PN 10/16	77,5	185	20	145	8	M16	18	6020
DN 100	101,6	PN 10/16	102,6	220	22	180	8	M16	18	6025

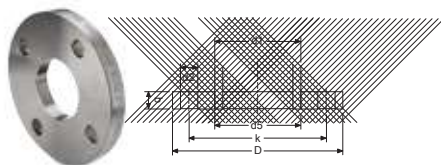

DIN plokšti virinami flanšai Tipas 01A

Nom. srg.	d1	Slėgis	Flanšai				Varžtai			Busgeriau nr.
			d5	D	b	k	vnt.	Sriegis M.	d2	
DN 15	19,0	PN 10/16/25/40	20,0	95	14	65	4	12	14	6025
DN 20	23,0	PN 10/16/25/40	24,0	105	16	75	4	12	14	6025
DN 25	29,0	PN 10/16/25/40	30,0	115	16	85	4	12	14	6025
DN 32	35,0	PN 10/16/25/40	36,0	140	18	100	4	16	18	6025
DN 40	41,0	PN 10/16/25/40	42,0	150	18	110	4	16	18	6025
DN 50	53,0	PN 10/16	54,0	165	20	125	4	16	18	6025
DN 65 - 4h	70,0	PN 10/16	71,5	185	20	145	4	16	18	6025
DN 80	85,0	PN 10/16	86,5	200	20	160	8	16	18	6025
DN 100	104,0	PN 10/16	105,5	220	22	180	8	16	18	6025
DN 125	129,0	PN 10/16	130,5	250	22	210	8	16	18	6025
DN 150	154,0	PN 10/16	155,5	285	24	240	8	20	22	6025
DN 200	204,0	PN 10	205,5	340	24	295	8	20	22	6025

04 Antgaliai & Užspaudėjai



04 Antgaliai & Užspaudėjai

Paviršius maks Ra 0,8 my – visos tarpinės turi maistinį sertifikatą FDA

Dalys DS antgaliams

Maks. slėgis 25 bar

Busgeriau nr. 8813
AISI 304

9811
AISI 316L

9812
AISI 316L

8814E - EPDM
8814N - NBR
8814T - PTFE
8814V - Viton

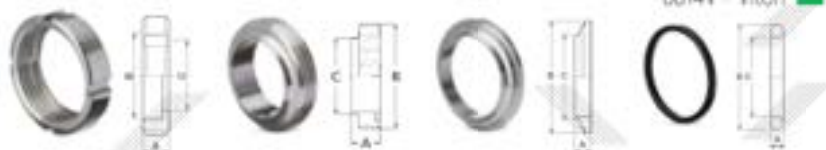

DS veržlė

DS virinama vyr. dalis

DS virinamas įdėklas

DS tarpinė

Nom. srg.	DS veržlė			DS virinama vyr. dalis			DS virinamas įdėklas			DS tarpinė		
	A mm	B mm	C mm	A mm	B mm	C mm	A mm	B mm	C mm	A mm	B mm	C mm
25,0	20,0	44x1/6	35,0	18,5	44x1/6	25,6	11,0	39,5	25,6	4,5	32,0	25,0
38,0	20,0	58x1/6	48,5	20,0	58x1/6	38,5	11,0	53,5	38,5	4,5	47,0	38,0
51,0	22,0	72x1/6	62,5	20,0	72x1/6	51,5	11,0	67,5	51,5	4,5	59,0	51,0
63,5	24,0	88x1/6	76,5	24,0	88x1/6	63,9	12,0	83,5	63,9	4,5	74,5	63,5
76,1	25,0	100x1/6	88,5	24,0	100x1/6	76,6	12,0	95,7	76,6	4,5	88,0	76,0
101,6	28,0	130x1/6	117,0	24,0	130x1/6	102,3	12,0	124,0	102,3	4,5	112,5	101,6

Busgeriau nr. 8816
AISI 304

8817
AISI 304

9818
AISI 316L

8819
AISI 304

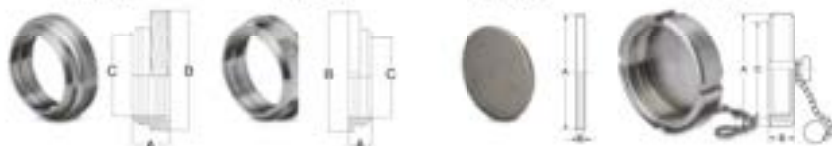

DS platėjanti vyr. dalis

DS platėjantis įdėklas

DS aklė

DS dangtelis su grandin.





Nom. srg.	DS platėjanti vyr. dalis			DS platėjantis įdėklas			DS aklė		DS dangtelis su grandin.		
	A mm	B mm	C mm	A mm	B mm	C mm	A mm	B mm	A mm	B mm	C mm
25,0	20,0	44x1/6	25,2	16,0	39,5	25,2	40,0	3,0	57,0	20,0	44x1/6
38,0	22,0	58x1/6	38,2	18,0	53,5	38,2	54,0	3,0	72,0	20,0	58x1/6
51,0	24,0	72x1/6	51,1	20,0	67,5	51,1	68,0	3,0	86,0	22,0	72x1/6
63,5	26,0	88x1/6	63,7	22,0	83,5	63,7	84,0	4,0	103,0	24,0	88x1/6
76,1	28,0	100x1/6	76,4	24,0	95,5	76,4	96,0	4,0	115,0	25,0	100x1/6
101,6	34,0	130x1/6	102,0	29,0	124,0	102,0	124,0	4,0	147,0	28,0	130x1/6

04 Antgaliai & Užspaudėjai

Paviršius maks Ra 0,8 my – visos tarpinės turi maistinį sertifikatą FDA

Dalys SMS virinamai jungčiai Maks. slėgis 25 bar

Busgeriau nr.	8823 AISI 304			8823KM AISI 304			9821 AISI 316L			9821L AISI 316L		
												
	SMS veržlė			SMS veržlė, sunki			SMS vyr. dalis			SMS vyr. dalis, ilga		
Nom. srg.	A	B	C	A	B	C	A	B	C	A	B	C
25,0	19,0	40x1/6	32,5	20,0	40x1/6	32,5	15,0	40,0	25,0	19,0	40x1/6	25,0
38,0	23,0	60x1/6	48,5	25,0	60x1/6	48,5	20,0	60,0	38,0	23,0	60x1/6	38,0
51,0	24,0	70x1/6	61,0	26,0	70x1/6	61,0	20,0	70,0	51,0	23,0	70x1/6	51,0
63,5	28,0	85x1/6	74,0	30,0	85x1/6	74,0	24,0	85,0	63,5	27,0	85x1/6	63,5
76,1	30,0	98x1/6	87,0	32,0	98x1/6	87,0	24,0	98,0	76,1	27,0	98x1/6	76,1
101,6	31,0	132x1/6	117,0	45,0	132x1/6	117,0	35,0	132,0	102,5	35,0	132x1/6	102,5

Busgeriau nr.	9822 AISI 316L			9822L AISI 316L			9822K AISI 316L			8824E - EPDM			8824N - NBR			8824T - PTFE			8824V - Viton		
																					
	SMS įdėklas			SMS įdėklas, ilgas			SMS įdėklas, trumpas			SMS tarpinė											
Nom. srg.	A	B	C	A	B	C	A	B	C	A	B	C	A	B	C	A	B	C	A	B	C
25,0	15,5	35,5	25,0	17,0	35,5	25,0	7,5	35,5	25,0	32,0	25,0	5,5									
38,0	16,0	55,0	38,0	20,0	55,0	38,0	8,0	55,0	38,0	48,0	38,0	5,5									
51,0	17,0	65,0	51,0	20,0	65,0	51,0	9,0	65,0	51,0	61,0	51,0	5,5									
63,5	17,0	80,0	63,5	25,0	80,0	63,5	9,0	80,0	63,5	73,5	63,5	5,5									
76,1	19,0	93,0	76,1	30,0	93,0	76,1	9,0	93,0	76,1	86,0	76,1	5,5									
101,6	19,0	127,0	102,5	35,0	127,0	102,5	12,0	127,0	102,5	113,5	101,6	5,5									

04 Antgaliai & Užspaudėjai

Paviršius maks. Ra 0,8 my – visos tarpinės turi maistinį sertifikatą FDA



Dalys SMS viriniamai jungčiai Maks. Slėgis 25 bar

Busgeriau nr.

9828
AISI 316L



SMS akelė

8829
AISI 304



SMS dangtelis su grandine

Nom. srg.	SMS akelė		SMS dangtelis su grandine		
	A	B	A	B	C
25,0	35,5	3,0	51,0	19,0	40x1/6
38,0	55,0	3,0	74,0	23,0	60x1/6
51,0	65,0	3,0	84,0	24,0	70x1/6
63,5	80,0	4,0	100,0	28,0	85x1/6
76,1	99,0	4,0	114,0	30,0	96x1/6
101,6	127,0	4,0	150,0	30,0	132x1/6



04 Antgaliai & Užspaudėjai

Paviršius maks. Ra 0,8 my – visos tarpinės turi maistinį sertifikatą FDA

Dalys DIN 11851 virinamai jungčiai

Maks. slėgis: DN 15-40 = 40 bar, DN 50-100 = 25 bar, DN 125-150 = 10 bar

Busgeriau nr.



DIN varžle mot.

DIN vyr. dalis SC

DIN įdėklas SD

DN	Vam.diam.	A	B	C	D	A	B	C	D	A	B	C	D
10	13,0	19,0	35,0	28x1/8	18,0	28x1/8	13,0	10,0	21,0	22,5	13,0	10,0	17,0
15	19,0	25,0	44,0	34x1/8	18,0	34x1/8	19,0	16,0	21,0	28,5	19,0	16,0	17,0
20	23,0	31,0	54,0	44x1/6	21,0	44x1/6	23,0	20,0	24,0	36,5	23,0	20,0	18,0
25	29,0	36,0	63,0	52x1/6	21,0	52x1/6	29,0	26,0	29,0	44,0	29,0	26,0	22,0
32	35,0	42,0	70,0	58x1/6	21,0	58x1/6	35,0	32,0	32,0	50,0	35,0	32,0	25,0
40	41,0	49,0	78,0	65x1/6	21,0	65x1/6	41,0	38,0	33,0	56,0	41,0	38,0	26,0
50	53,0	62,0	92,0	78x1/6	22,0	78x1/6	53,0	50,0	35,0	68,5	53,0	50,0	28,0
65	70,0	80,0	112,0	95x1/6	25,0	95x1/6	70,0	66,0	40,0	86,0	70,0	66,0	32,0
80	85,0	94,0	127,0	110x1/4	30,0	110x1/4	85,0	81,0	45,0	100,0	85,0	81,0	37,0
100	104,0	115,0	148,0	130x1/4	31,0	130x1/4	104,0	100,0	54,0	121,0	104,0	100,0	44,0
125	129,0	138,0	178,0	160x1/4	35,0	160x1/4	129,0	125,0	46,0	150,0	129,0	125,0	34,0
150	154,0	164,0	210,0	190x1/4	40,0	190x1/4	154,0	150,0	50,0	176,0	154,0	150,0	37,0

Busgeriau nr.

8834E - EPDM
 8834N - NBR
 8834V - Viton

9838
AISI 316L

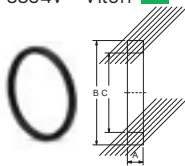

DIN tarpinė

DIN akliė D

DN	Vamzdis srg.Ø	Ø	T	A	B	C	
10	13,0	20,0	12,0	4,5	22,0	18,0	9,0
15	19,0	26,0	18,0	4,5	28,0	24,0	9,0
20	23,0	33,0	23,0	4,5	36,0	30,0	11,0
25	29,0	40,0	30,0	5,0	44,0	35,0	13,0
32	35,0	46,0	36,0	5,0	50,0	41,0	13,0
40	41,0	52,0	42,0	5,0	56,0	48,0	13,0
50	53,0	64,0	54,0	5,0	68,0	61,0	14,0
65	70,0	81,0	71,0	5,0	86,0	79,0	16,0
80	85,0	95,0	85,0	5,0	100,0	93,0	16,0
100	104,0	114,0	104,0	6,0	121,0	114,0	20,0
125	129,0	142,0	130,0	7,0	150,0	137,0	22,0
150	154,0	167,0	155,0	7,0	176,0	163,0	24,0

Visos pozicijos sandėliuojamos

04 Antgaliai & Užspaudėjai



Paviršius Ra 0,8 my – visos tarpinės turi maistinį sertifikatą FDA

DIN 11864-1 / DIN 11853-1 virinama jungtis

Maks. slėgis DN 15-40 = 40 bar, DN 50-100 = 25 bar



Ilga versija

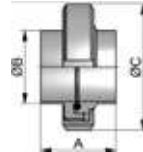

Trumpa versija

DN	B	C	Jungties Sriegis	A	DIN 11864-1	A	DIN 11853-1
10	13,0	38	28x1/8	76	●	32	○
15	19,0	44	34x1/8	76	●	32	○
20	23,0	54	44x1/6	76	●	34	○
25	29,0	63	52x1/6	77	●	42	○
32	35,0	70	58x1/6	88	●	48	○
40	41,0	78	65x1/6	88	●	50	○
50	53,0	92	78x1/6	89	●	54	○
65	70,0	112	95x1/6	113	●	62	○
80	85,0	127	110x1/4	117	●	72	○
100	104,0	148	130x1/4	120	●	86	○

ISO	B	C	Jungties Sriegis	A	DIN 11864-1	E	DIN 11853-1
13,5	13,5	38	28x1/8	76	○	32	○
17,2	17,2	44	34x1/8	76	○	32	○
21,3	21,3	54	44x1/6	78	○	34	○
26,9	26,9	63	52x1/6	78	○	42	○
33,7	33,7	70	58x1/6	88	○	48	○
42,4	42,4	78	65x1/6	88	○	50	○
48,3	48,3	92	78x1/6	90	○	54	○
60,3	60,3	112	95x1/6	114	○	62	○
76,1	76,1	127	110x1/4	117	○	72	○
88,9	88,9	148	130x1/4	122	○	86	○
114,3	114,3	178	160x1/4	130	○	-	-

Coliai	B	C	Jungties Sriegis	A	DIN 11864-1	E	DIN 11853-1
0,5"	12,7	38	28x1/8	76	○	32	○
0,75"	19,05	44	34x1/8	76	○	32	○
1"	25,4	63	52x1/6	77	○	42	○
1,5"	38,1	78	65x1/6	88	○	50	○
2"	50,8	92	78x1/6	89	○	54	○
2,5"	63,5	112	95x1/6	115	○	62	○
3"	76,2	127	110x1/4	117	○	72	○
4"	101,6	148	130x1/4	119	○	86	○

● = Sandėliuojama ○ = Užsakoma

DIN 11864-1 / DIN 11853-1 gali būti patiekti ir EN 1.4404 su paviršiumi maks. Ra 0,4 μm

DIN 11864-1 / DIN 11853-1 gali būti patiekti ir EN 1.4435 su paviršiumi maks. Ra 0,4 μm arba 0,25 μm (elektropoliruoti)

04 Antgaliai & Užspaudėjai



Dalyas DIN 11864-1 / DIN 11853-1 virinamai jungčiais

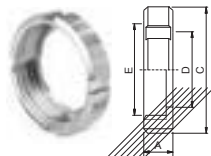

Veržlė mot.

Busgeriau nr.

8843

9843

DN	Vam.diam. A	C	D	E	AISI 304L	AISI 316L
10	13,0	18	38	19	28x1/8	● ○
15	19,0	18	44	25	34x1/8	● ○
20	23,0	20	54	31	44x1/6	● ○
25	29,0	21	63	36	52x1/6	● ○
32	35,0	21	70	42	58x1/6	● ○
40	41,0	21	78	49	65x1/6	● ○
50	53,0	22	92	62	78x1/6	● ○
65	70,0	25	112	80	95x1/6	● ○
80	85,0	29	127	94	110x1/4	● ○
100	104,0	31	148	115	130x1/4	● ○

ISO	Vam.diam. A	C	D	E	AISI 304L	AISI 316L
13,5	13,5	18	38	19	28x1/8	○ ○
17,2	17,2	18	44	25	34x1/8	○ ○
21,3	21,3	20	54	31	44x1/6	○ ○
26,9	26,9	21	63	36	52x1/6	○ ○
33,7	33,7	21	70	42	58x1/6	○ ○
42,4	42,4	21	78	49	65x1/6	○ ○
48,3	48,3	22	92	62	78x1/6	○ ○
60,3	60,3	25	112	80	95x1/6	○ ○
76,1	76,1	29	127	94	110x1/4	○ ○
88,9	88,9	31	148	115	130x1/4	○ ○
114,3	114,3	35	178	138	160x1/4	○ ○

Colia	Vam.diam. A	C	D	E	AISI 304L	AISI 316L
0,5"	12,7	18	38	19	28x1/8	○ ○
0,75"	19,05	18	44	25	34x1/8	○ ○
1"	25,4	21	63	36	52x1/6	○ ○
1,5"	38,1	21	78	49	65x1/6	○ ○
2"	50,8	22	92	62	78x1/6	○ ○
2,5"	63,5	25	112	80	95x1/6	○ ○
3"	76,2	29	127	94	110x1/4	○ ○
4"	101,6	31	148	115	130x1/4	○ ○

● = Sandėliuojama

○ = Užsakoma

pardavimai@busgeriau.lt +37066276762



04 Antgaliai & Užspaudėjai

Dalys DIN 11864-1 / DIN 11853-1 virinamai jungčiai

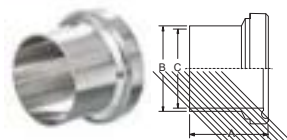
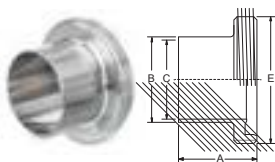

vyr dalis GS

idėklas BS

Busgeriau nr.				9841L		9841		9842L		9842	
				DIN 11864		DIN 11853		DIN 11864		DIN 11853	
				Ilgą versija		Trumpa versija		Ilgą versija		Trumpa versija	
DN	B	C	E	A	AISI 316L	A	AISI 316L	A	AISI 316L	A	AISI 316L
10	13,0	10,0	28x1/8	41,0	●	19,0	○	39,0	●	17,0	○
15	19,0	16,0	34x1/8	41,0	●	19,0	○	39,0	●	17,0	○
20	23,0	20,0	44x1/6	43,0	●	21,0	○	38,0	●	18,0	○
25	29,0	26,0	52x1/6	43,0	●	26,0	○	40,0	●	22,0	○
32	35,0	32,0	58x1/6	48,0	●	30,0	○	47,0	●	25,0	○
40	41,0	38,0	65x1/6	48,0	●	31,0	○	47,0	●	26,0	○
50	53,0	50,0	78x1/6	48,0	●	31,0	○	48,0	●	30,0	○
65	70,0	66,0	95x1/6	60,0	●	36,0	○	61,0	●	34,0	○
80	85,0	81,0	110x1/4	64,0	●	42,0	○	61,0	●	38,0	○
100	104,0	100,0	130x1/4	64,0	●	50,0	○	66,0	●	46,0	○
ISO	B	C	E	A	AISI 316L	A	AISI 316L	A	AISI 316L	A	AISI 316L
13,5	13,5	10,3	28x1/8	41,0	○	19,0	○	39,0	○	17,0	○
17,2	17,2	14,0	34x1/8	41,0	○	19,0	○	39,0	○	17,0	○
21,3	21,3	18,1	44x1/6	43,0	○	21,0	○	40,0	○	18,0	○
26,9	26,9	23,7	52x1/6	43,0	○	26,0	○	41,0	○	22,0	○
33,7	33,7	29,7	58x1/6	48,0	○	30,0	○	47,0	○	25,0	○
42,4	42,4	38,4	65x1/6	48,0	○	31,0	○	47,0	○	26,0	○
48,3	48,3	44,3	78x1/6	49,0	○	31,0	○	48,0	○	30,0	○
60,3	60,3	56,3	95x1/6	60,0	○	36,0	○	62,0	○	34,0	○
76,1	76,1	72,1	110x1/4	64,0	○	42,0	○	61,0	○	38,0	○
88,9	88,9	84,3	130x1/4	64,0	○	50,0	○	68,0	○	46,0	○
114,3	114,3	109,7	160x1/4	68,0	○			72,0	○		
Coliai	B	C	E	A	AISI 316L	A	AISI 316L	A	AISI 316L	A	AISI 316L
0,5"	12,7	9,4	28x1/8	41,0	○	19,0	○	39,0	○	17,0	○
0,75"	19,05	15,75	34x1/8	41,0	○	19,0	○	39,0	○	17,0	○
1"	25,4	22,1	52x1/6	43,0	○	26,0	○	40,0	○	22,0	○
1,5"	38,1	34,8	65x1/6	48,5	○	31,0	○	46,5	○	26,0	○
2"	50,8	47,5	78x1/6	48,5	○	31,0	○	47,5	○	30,0	○
2,5"	63,5	60,2	95x1/6	60,0	○	36,0	○	63,0	○	34,0	○
3"	76,2	72,9	110x1/4	64,0	○	42,0	○	61,0	○	38,0	○
4"	101,6	97,4	130x1/4	64,0	○	50,0	○	65,0	○	46,0	○

● = Sandėliuojama ○ = Užsakoma pardavimai@busgeriau.lt + 37066276762

04 Antgaliai & Užspaudėjai



Dalys DIN 11864-1 / DIN 11853-1 virinamos jungčiai

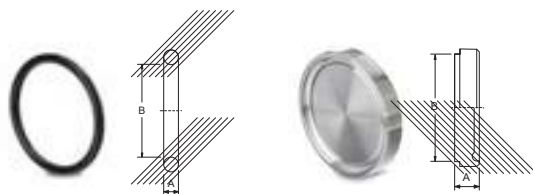

O-žiedas

Aklė BBS

Busgeriau nr.		O-žiedas					Aklė BBS		
DN	Vam.diam.	A	B	8844E EPDM	8844V VITON	8844N NBR	A	B	9848 AISI 3016L
10	13,0	3,5	12,0	●	●	○	9	18	●
15	19,0	3,5	18,0	●	●	○	9	24	●
20	23,0	3,5	22,0	●	●	○	10	30	●
25	29,0	3,5	28,0	●	●	○	12	35	●
32	35,0	5,0	34,0	●	●	○	13	41	●
40	41,0	5,0	40,0	●	●	○	13	48	●
50	53,0	5,0	52,0	●	●	○	14	61	●
65	70,0	5,0	68,0	●	●	○	16	79	●
80	85,0	5,0	83,0	●	●	○	16	93	●
100	104,0	5,0	102,0	●	●	○	20	114	●

ISO	Vam.diam.	A	B	EPDM	VITON	NBR	A	B	AISI 316L
13,5	13,5	3,5	12,0	○	○	○	9	18	○
17,2	17,2	3,5	16,0	○	○	○	9	24	○
21,3	21,3	3,5	20,0	○	○	○	10	30	○
26,9	26,9	3,5	26,0	○	○	○	12	35	○
33,7	33,7	5,0	32,0	○	○	○	13	41	○
42,4	42,4	5,0	40,5	○	○	○	13	48	○
48,3	48,3	5,0	46,5	○	○	○	14	61	○
60,3	60,3	5,0	58,5	○	○	○	16	79	○
76,1	76,1	5,0	73,5	○	○	○	16	93	○
88,9	88,9	5,0	86,5	○	○	○	20	114	○
114,3	114,3	5,0	111,0	○	○	○	22	137	○

Coliai	Vam.diam	A	B	EPDM	VITON	NBR	A	B	AISI 316L
0,5"	12,7	3,5	12,0	○	○	○	9	18	○
0,75"	19,05	3,5	18,0	○	○	○	9	24	○
1"	25,4	3,5	24,0	○	○	○	12	35	○
1,5"	38,1	5,0	37,0	○	○	○	13	48	○
2"	50,8	5,0	50,0	○	○	○	14	61	○
2,5"	63,5	5,0	62,0	○	○	○	16	79	○
3"	76,2	5,0	75,0	○	○	○	16	93	○
4"	101,6	5,0	100,0	○	○	○	20	114	○

● = Sandėliuojama ○ = Užsakoma pardavimai@busgeriau.lt + 37066276762

04 Antgaliai & Užspaudėjai



Paviršius maks. Ra 0,8 my – visos tarpinės turi maistinį sertifikatą FDA

DIN 11864-2 / DIN 11853-2 flanšinė jungtis

Maks. slėgis DN 15-40 = 40 bar, DN 50-100 = 25 bar, DN 125-150 = 10 bar

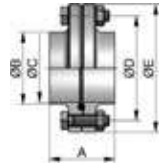
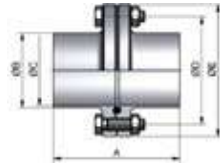

Ilga verija

Trumpa versija

DN	B	C	D	E	Varžtai	A	DIN 11864-2	A	DIN 11853-2
10	13,0	10,0	37	65	4x M8x30	80	●	48	●
15	19,0	16,0	42	59	4x M8x30	80	●	48	●
20	23,0	20,0	47	64	4x M8x30	80	●	48	●
25	29,0	26,0	53	70	4x M8x30	80	●	48	●
32	35,0	32,0	59	76	4x M8x30	90	●	48	●
40	41,0	38,0	65	82	4x M8x30	90	●	48	●
50	53,0	50,0	77	94	4x M8x30	90	●	48	●
65	70,0	66,0	95	113	8x M8x30	108	●	48	●
80	85,0	81,0	112	133	8x M10x35	116	●	52	●
100	104,0	100,0	137	159	8x M10x40	116	●	52	●
125	129,0	125,0	161	183	8x M10x40	120	●	56	●
150	154,0	150,0	188	213	8x M12x50	120	●	56	●

ISO	B	C	D	E	Varžtai	A	DIN 11864-2	A	DIN 11853-2
13,5	13,5	10,3	37	54	4x M8x30	80	○	48	○
17,2	17,2	14,0	42	59	4x M8x30	80	○	48	○
21,3	21,3	18,1	45	62	4x M8x30	80	○	48	○
26,9	26,9	23,7	52	69	4x M8x30	80	○	48	○
33,7	33,7	29,7	57	74	4x M8x30	90	○	48	○
42,4	42,4	38,4	65	82	4x M8x30	90	○	48	○
48,3	48,3	44,3	71	88	4x M8x30	90	○	48	○
60,3	60,3	56,3	85	103	4x M8x30	108	○	48	○
76,1	76,1	72,1	104	125	8x M10x35	112	○	48	○
88,9	88,9	94,3	116	137	8x M10x35	116	○	52	○
114,3	114,3	109,7	146	168	8x M10x40	116	○	52	○

Coliai	B	C	D	E	Varžtai	A	DIN 11864-2	A	DIN 11853-2
0,5"	12,7	9,4	37	54	4x M8x30	80	○	48	○
0,75"	19,05	15,75	42	59	4x M8x30	80	○	48	○
1"	25,4	22,1	49	66	4x M8x30	80	○	48	○
1,5"	38,1	34,8	62	79	4x M8x30	90	○	48	○
2"	50,8	47,5	75	92	4x M8x30	90	○	48	○
2,5"	63,5	60,2	89	107	8x M8x30	108	○	48	○
3"	76,2	72,9	104	128	8x M10x35	112	○	48	○
4"	101,6	97,4	135	157	8x M10x40	116	○	52	○

● = Sandėliuojama ○ = Užsakoma

DIN 11864-2 / DIN 11853-2 gali būti patiektas ir EN 1.4404 su paviršiumi maks Ra 0,4 μm

DIN 11864-2 / DIN 11853-2 gali būti patiektas ir EN 1.4435 su paviršiumi maks Ra 0,4 μm arba 0,25 μm (elektropoliuotas)

04 Antgaliai & Užspaudėjai

DIN 11864-2 / DIN 11853-2 flanšinė jungtis

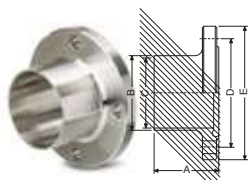

veržlė flanšas NF

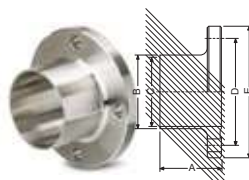

Įdėklas flanšas BF

Busgeriau nr.	9852L DIN 11864, ilgas				9852 DIN11853, trumpas				9851L DIN 11864, ilgas				9851 DIN11853, trumpas			
	DN	Vam.diam.	A	AISI 316L	A	AISI 316L	A	AISI 316L	A	AISI 316L	A	AISI 316L	A	AISI 316L		
	10	13,0	41,5	●	25,5	●	40,0	●	24,0	●						
	15	19,0	41,5	●	25,5	●	40,0	●	24,0	●						
	20	23,0	41,5	●	25,5	●	40,0	●	24,0	●						
	25	29,0	41,5	●	25,5	●	40,0	●	24,0	●						
	32	35,0	46,5	●	25,5	●	45,0	●	24,0	●						
	40	41,0	46,5	●	25,5	●	45,0	●	24,0	●						
	50	53,0	46,5	●	25,5	●	45,0	●	24,0	●						
	65	70,0	55,5	●	25,5	●	54,0	●	24,0	●						
	80	85,0	59,5	●	27,5	●	58,0	●	26,0	●						
	100	104,0	59,5	●	27,5	●	58,0	●	26,0	●						
	125	129,0	61,5	●	29,5	●	60,0	●	28,0	●						
	150	154,0	61,5	●	29,5	●	60,0	●	28,0	●						

ISO Vam.diam.	A	AISI 316L	A	AISI 316L	A	AISI 316L	A	AISI 316L	
13,5	13,5	41,5	○	25,5	○	40,0	○	24,0	○
17,2	17,2	41,5	○	25,5	○	40,0	○	24,0	○
21,3	21,3	41,5	○	25,5	○	40,0	○	24,0	○
26,9	26,9	41,5	○	25,5	○	40,0	○	24,0	○
33,7	33,7	46,5	○	25,5	○	45,0	○	24,0	○
42,4	42,4	46,5	○	25,5	○	45,0	○	24,0	○
48,3	48,3	46,5	○	25,5	○	45,0	○	24,0	○
60,3	60,3	55,5	○	25,5	○	54,0	○	24,0	○
76,1	76,1	57,5	○	25,5	○	56,0	○	24,0	○
88,9	88,9	59,5	○	27,5	○	58,0	○	26,0	○
114,3	114,3	59,5	○	27,5	○	58,0	○	26,0	○

Coliai Vam.diam.	A	AISI 316L	A	AISI 316L	A	AISI 316L	A	AISI 316L	
0,5"	12,7	41,5	○	25,5	○	40,0	○	24,0	○
0,75"	19,05	41,5	○	25,5	○	40,0	○	24,0	○
1"	25,4	41,5	○	25,5	○	40,0	○	24,0	○
1,5"	38,1	46,5	○	25,5	○	45,0	○	24,0	○
2"	50,8	46,5	○	25,5	○	45,0	○	24,0	○
2,5"	63,5	55,5	○	25,5	○	54,0	○	24,0	○
3"	76,2	57,5	○	25,5	○	56,0	○	24,0	○
4"	101,6	59,5	○	27,5	○	58,0	○	26,0	○

● = Sandėliuojama

○ = Užsakoma

pardavimai@busgeriau.lt +37066276762

04 Antgaliai & Užspaudėjai

DIN 11864-2 / DIN 11853-2 flanšinė jungtis

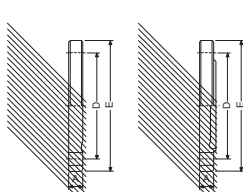

Akle įdėklas **Akle veržlė**
Flanšinis BBF Flanšas BNF

9859 9858

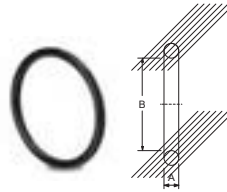

O-žiedas

8844E 8844V 8844N



Varžtų rinkinys

9854

Busgeriau nr.

DN	Vam.diam.	A	AISI 316L	A	AISI 316L	A	B	EPDM	VITON	NBR	vnt. / srg.	A2/A4
10	13,0	10,0	○	11,5	○	3,5	12,0	●	●	○	4x M8x30	●
15	19,0	10,0	○	11,5	○	3,5	18,0	●	●	○	4x M8x30	●
20	23,0	10,0	○	11,5	○	3,5	22,0	●	●	○	4x M8x30	●
25	29,0	10,0	○	11,5	○	3,5	28,0	●	●	○	4x M8x30	●
32	35,0	10,0	○	11,5	○	5,0	34,0	●	●	○	4x M8x30	●
40	41,0	10,0	○	11,5	○	5,0	40,0	●	●	○	4x M8x30	●
50	53,0	10,0	○	11,5	○	5,0	52,0	●	●	○	4x M8x30	●
65	70,0	10,0	○	11,5	○	5,0	68,0	●	●	○	8x M8x30	●
80	85,0	12,0	○	13,5	○	5,0	83,0	●	●	○	8x M10x35	●
100	104,0	14,0	○	15,5	○	5,0	102,0	●	●	○	8x M10x40	●
125	129,0	14,0	○	15,5	○	5,0	127,0	●	○	○	8x M10x40	●
150	154,0	16,0	○	17,5	○	5,0	152,0	●	○	○	8x M12x50	●

DN	Vam.diam.	A	AISI 316L	A	AISI 316L	A	B	EPDM	VITON	NBR	vnt. / srg.	A2/A4
13,5	13,5	10,0	○	11,5	○	3,5	12,0	○	○	○	4x M8x30	○
17,2	17,2	10,0	○	11,5	○	3,5	16,0	○	○	○	4x M8x30	○
21,3	21,3	10,0	○	11,5	○	3,5	20,0	○	○	○	4x M8x30	○
26,9	26,9	10,0	○	11,5	○	3,5	26,0	○	○	○	4x M8x30	○
33,7	33,7	10,0	○	11,5	○	5,0	32,0	○	○	○	4x M8x30	○
42,4	42,4	10,0	○	11,5	○	5,0	40,5	○	○	○	4x M8x30	○
48,3	48,3	10,0	○	11,5	○	5,0	46,5	○	○	○	4x M8x30	○
60,3	60,3	10,0	○	11,5	○	5,0	58,5	○	○	○	4x M8x30	○
76,1	76,1	12,0	○	13,5	○	5,0	73,5	○	○	○	8x M10x35	○
88,9	88,9	12,0	○	13,5	○	5,0	86,5	○	○	○	8x M10x35	○
114,3	114,3	14,0	○	15,5	○	5,0	111,0	○	○	○	8x M10x40	○

DN	Vam.diam.	A	AISI 316L	A	AISI 316L	A	B	EPDM	VITON	NBR	vnt. / srg.	A2/A4
0,5"	12,7	10,0	○	11,5	○	3,5	12,0	○	○	○	4x M8x30	○
0,75"	19,05	10,0	○	11,5	○	3,5	18,0	○	○	○	4x M8x30	○
1"	25,4	10,0	○	11,5	○	3,5	24,0	○	○	○	4x M8x30	○
1,5"	38,1	10,0	○	11,5	○	5,0	37,0	○	○	○	4x M8x30	○
2"	50,8	10,0	○	11,5	○	5,0	50,0	○	○	○	4x M8x30	○
2,5"	63,5	10,0	○	11,5	○	5,0	62,0	○	○	○	8x M8x30	○
3"	76,2	12,0	○	13,5	○	5,0	75,0	○	○	○	8x M10x35	○
4"	101,6	14,0	○	15,5	○	5,0	100,0	○	○	○	8x M10x40	○

● = Sandėliuojama ○ = Užsakoma pardavimai@busgeriau.lt + 37066276762

04 Antgaliai & Užspaudėjai

Pažangios jungtys Užspaudimo žiedai

Slėgys išbandytas su Force Technology

Busgeriau nr.

Tipas



8861AC
senas Tipas S
(H-vyris)



9865AC
Tipas SH



9866AC
Tipas SSH
Aukštas slėgis

Užspaudimo žiedo išmatavimai

DS/SMS	DIN	ISO	Flanšas	Ø Maks Bar	AISI 304	Maks Bar	AISI 316L	Maks Bar	AISI 304
	6-18 (mini)	13,5-17,2	25,4	25	•	50	•	75	•
	13-23		34,0	25	•	50	•	75	•
25-38	29-41	21,3-33,7	50,5	25	•	50	•	75	•
51	53	42,4-48,3	64,0	25	•	50	•	75	•
63,5		60,3	77,5	25	•	50	•	75	•
76,1	70	76,1	91,0	20	•	40	•	60	•
	85	88,9	106,0	20	•	40	•	60	•
101,6	104		119,0	17	•	35	•	50	•
		114,3	130,0	15	•	30	•	45	•
	129		144,0			30	•		
	129	139,7	155,0			30	•	40	•
	154		167,0	15	•	30	•	40	•
	154	168,3	183,0			25	•	40	•
	204		218,0			20	•		
	204	219,1	233,5			20	•	30	•
	254		268,0			16	•		
		273,0	286,0			16	•		
	304		319,0			10	•		
		323,9	338,5			10	•		



8861
13GH vienas vyris
(H-vyris)



9865
13EU dvigubas vyris
(Tipas SH)



9866
13MHP
Aukštas slėgis

Užspaudimo žiedai

Busgeriau nr.

su 3.1 sertifikatu

Tipas

Užspaudimo žiedo išmatavimai

DS/SMS	DIN	ISO	Flanšas Ø mm	Maks Bar	AISI 304	Maks Bar	AISI 316L	Maks Bar	AISI 304
	6-18 (mini)	17,2	25,4	20	•	50	•	75	○
	13-23		34,0	20	•	50	•	75	○
25-38	29-41	21,3-33,7	50,5	20	•	50	•	70	○
51	53	42,4-48,3	64,0	20	•	50	•	70	○
63,5		60,3	77,5	15	•	50	•	70	○
76,1	70	76,1	91,0	10	•	40	•	55	○
	85	88,9	106,0	10	•	40	•	55	○
101,6	104		119,0	10	•	35	•	45	○
		114,3	130,0	8	•	30	•	40	○
	129	139,7	155,0	8	•	30	•	30	○
	154	168,3	183,0	6	•	25	•	25	○
	204	219,1	233,5	4	•	20	•	20	○

04 Antgaliai & Užspaudėjai



Paviršius maks Ra 0,8 my – visos tarpinės turi maistinį sertifikatą FDA

Užspaudėju antgaliai ir tarpinės



9862



8863

Busgeriau nr.

ISO 2852 / SMS 3017

D x T	Flanšas	ØAukštis	316L	Tarpinės						
				NBR	EPDM	VITON	VMQ	PTFE	PTFE+FPM	PTFE+EDPM
25,6 x 1,5	50,5	21,5	●	●	●	●	●	●	●	●
38,6 x 1,5	50,5	21,5	●	●	●	●	●	●	●	●
51,6 x 1,5	64,0	21,5	●	●	●	●	●	●	●	●
64,1 x 1,9	77,5	21,5	●	●	●	●	●	●	●	●
76,7 x 1,9	91,0	21,5	●	●	●	●	●	●	●	●
102,5 x 2,45	119,0	21,5	●	●	●	●	●	●	●	●

DS / SMS 3008

D x T	Flanšas	ØAukštis	316L	Tarpinės						
				NBR	EPDM	VITON	VMQ	PTFE	PTFE+FPM	PTFE+EDPM
25,0 x 1,2	50,5	21,5 / 28,6	●/●	●	●	●	●	●	●	●
38,0 x 1,2	50,5	21,5 / 28,6	●/●	●	●	●	●	●	●	●
51,0 x 1,2	64,0	21,5 / 28,6	●/●	●	●	●	●	●	●	●
63,5 x 1,6	77,5	21,5 / 28,6	●/●	●	●	●	●	●	●	●
76,1 x 1,6	91,0	21,5 / 28,6	●/○	●	●	●	●	●	●	●
76,1 x 2,0	91,0	21,5 / 28,6	●/●	●	●	●	●	●	●	●
101,6 x 2,0	119,0	21,5 / 28,6	●/●	●	●	●	●	●	●	●

DIN 32676

D x T	Flanšas	ØAukštis	316L	Tarpinės						
				NBR	EPDM	VITON	VMQ	PTFE	PTFE+FPM	PTFE+EDPM
13,0 x 1,5	34,0	18,0	●	○	●	●	○	●	○	○
19,0 x 1,5	34,0	18,0	●	○	●	●	○	●	○	○
23,0 x 1,5	34,0	18,0	●	○	●	●	○	●	○	○
29,0 x 1,5	50,5	21,5	●	○	●	●	○	●	○	○
35,0 x 1,5	50,5	21,5	●	○	●	●	○	●	○	○
41,0 x 1,5	50,5	21,5	●	○	●	●	○	●	○	○
53,0 x 1,5	64,0	21,5	●	○	●	●	○	●	○	○
70,0 x 2,0	91,0	28,0	●	○	●	●	○	●	○	○
85,0 x 2,0	106,0	28,0	●	○	●	●	○	●	○	○
104,0 x 2,0	119,0	28,0	●	○	●	●	○	●	○	○
129,0 x 2,0	155,0	28,0	●	○	●	○	○	●	○	○
154,0 x 2,0	183,0	28,0	●	○	●	○	○	●	○	○
204,0 x 2,0	233,5	28,0	●	○	●	○	○	●	○	○

● = Sandėliuojama ○ = Užsakoma

Visos sandėlyje esančios tarpinės yra su lūpomis, be gali būti tiekiamos su trumpu pristatymo laiku. tęsinys 14

04 Antgaliai & Užspaudėjai



Paviršius maks Ra 0,8 my – visos tarpinės turi maistinį sertifikatą FDA

Užspaudimo antgaliai ir tarpinės



9862



8863

Busgeriau nr.

DIN (nestandartas)

D x T	Flanšas Ø	Aukštis	316L	Tarpinės						
				NBR	EPDM	VITON	VMQ	PTFE	PTFE+FPM	PTFE+EDPM
129,0 x 2,0	144,0	28,0	●	○	●	○	○	○	○	○
154,0 x 2,0	167,0	28,0	●	○	●	○	○	○	○	○
204,0 x 2,0	218,0	28,0	●	○	●	○	○	○	○	○
254,0 x 2,0	268,0	28,0	●	○	●	○	○	○	○	○
304,0 x 2,0	319,0	28,0	●	○	●	○	○	○	○	○

ISO 1127

D x T	Flanšas Ø	Aukštis	316L	Tarpinės						
				NBR	EPDM	VITON	VMQ	PTFE	PTFE+FPM	PTFE+EDPM
13,5 x 1,6	25,4	21,5	●	○	●	○	○	○	○	○
13,5 x 1,6	50,5	21,5	○	○	○	○	○	○	○	○
17,2 x 1,6	25,4	21,5	●	○	●	○	○	○	○	○
17,2 x 1,6	50,5	21,5	●	○	●	○	○	○	○	○
21,3 x 1,6	50,5	21,5	●	○	●	○	○	○	○	○
26,9 x 2,0	50,5	21,5	●	○	●	○	○	○	○	○
33,7 x 2,0	50,5	21,5	●	○	●	○	○	○	○	○
42,4 x 2,0	64,0	21,5	●	○	●	○	○	○	○	○
48,3 x 2,0	64,0	21,5	●	○	●	○	○	○	○	○
60,3 x 2,0	77,5	21,5/28,0	●/○	○	●	○	○	○	○	○
76,1 x 2,0	91,0	21,5/28,0	●/○	○	●	○	○	○	○	○
88,9 x 2,0	106,0	21,5/28,0	●/○	○	●	○	○	○	○	○
114,3 x 2,0	130,0	28,0	●	○	●	○	○	○	○	○
139,7 x 2,0	155,0	28,0	●	○	●	○	○	○	○	○
168,3 x 2,6	183,0	28,0	●	○	●	○	○	○	○	○
219,1 x 2,6	233,5	28,0	●	○	●	○	○	○	○	○
273,0 x 2,6	286,0	28,0	●	○	●	○	○	○	○	○
323,9 x 2,6	338,5	28,0	●	○	●	○	○	○	○	○

MINI

D x T	Flanšas Ø	Aukštis	316L	Tarpinės						
				NBR	EPDM	VITON	VMQ	PTFE	PTFE+FPM	PTFE+EDPM
6,0 x 1,0	25,4	21,5	●	○	●	○	○	○	○	○
8,0 x 1,0	25,4	21,5	●	○	●	○	○	○	○	○
10,0 x 1,0	25,4	21,5	●	○	●	○	○	○	○	○
12,0 x 1,0	25,4	21,5	●	○	●	○	○	○	○	○
14,0 x 1,0	25,4	21,5	●	○	●	○	○	○	○	○
16,0 x 1,0	25,4	21,5	●	○	●	○	○	○	○	○
18,0 x 1,0	25,4	21,5	●	○	●	○	○	○	○	○

● = Sandėliuojama ○ = Užsakoma

Visos sandėlyje esančios tarpinės yra su lūpomis, be gali būti tiekiamos su trumpu pristatymo laiku.

04 Antgaliai & Užspaudėjai



Paviršius maks Ra 0,8 my – visos tarpinės turi maistinį sertifikatą FDA

Užspaudimo antgaliai ir tarpinės



9862



8863

Busgeriau nr.

D x T	ASME		316L	Pakninger						
	Flanšas Ø	Aukštis		NBR	EPDM	VITON	VMQ	PTFE	PTFE+FPM	PTFE+EDPM
6,35 x 0,89	25,4	21,5	○	○	○	○	○	○	○	○
9,53 x 0,89	25,4	21,5	○	○	○	○	○	○	○	○
12,7 x 1,65	25,4	21,5	●	○	●	○	○	○	○	○
19,05 x 1,65	25,4	21,5	●	○	●	○	○	○	○	○
25,4 x 1,65	50,5	21,5	○	○	○	○	○	○	○	○
38,1 x 1,65	50,5	21,5	○	○	○	○	○	○	○	○
50,8 x 1,65	64,0	28,0	○	○	○	○	○	○	○	○
63,5 x 1,65	77,5	28,0	○	○	○	○	○	○	○	○
76,2 x 1,65	91,0	28,0	○	○	○	○	○	○	○	○
101,6 x 2,1	119,0	28,0	○	○	○	○	○	○	○	○

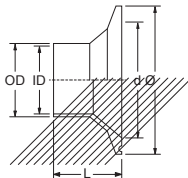

Užspaudimo antgaliai, redukciniai

DS/SMS/ISO

Busgeriau nr. 9869

srg. mm	Flanšas Ø	Flanšas d	Spaust. OD	Spaust. T	Spaust. ID	Aukštis L	316 L
38,0 / 25,0	50,5	35,6	25,0	1,2	22,6	21,5	●
51,0 / 25,0	64,0	48,6	25,0	1,2	22,6	21,5	●
51,0 / 38,0	64,0	48,6	38,0	1,2	35,6	21,5	●
63,5 / 38,0	77,5	60,3	38,0	1,2	35,6	21,5	●
63,5 / 51,0	77,5	60,3	51,0	1,2	48,6	21,5	●
76,1 / 51,0	91,0	72,9	51,0	1,2	48,6	28,0	●
76,1 / 63,5	91,0	72,9	63,5	1,6	60,3	28,0	●
101,6 / 76,1	119,0	97,6	76,1	1,6	72,9	28,0	●

● = Sandėliuojama ○ = Užsakoma

Visos sandėlyje esančios tarpinės yra su lūpomis, be gali būti tiekiamos su trupu pristatymo laiku.

04 Antgaliai & Užspaudėjai



Užspaudimo antgaliai

Busgeriau nr.

išorė BSPT sriegis

9867

Tinka užspaudimo antgaliai		išorinis sriegis		Išmatavimai (mm)			AISI 316L
DS/SMS	MINI	BSPT	Flanšas D	Vidus B	Ilgis L		
	10 mm	1/8"	25,4	8,0	25	●	
	12 mm	1/4"	25,4	10,0	25	●	
	18 mm	1/4"	25,4	16,0	25	●	
		3/8"	25,4	16,0	25	●	
	25 mm	1/2"	25,4	16,0	30	●	
		1/4"	50,5	22,6	30	●	
		3/8"	50,5	22,6	30	●	
		1/2"	50,5	22,6	30	●	
	38 mm	3/4"	50,5	22,6	30	●	
		1"	50,5	22,6	35	●	
		1/4"	50,5	35,6	35	●	
		3/8"	50,5	35,6	35	●	
		1/2"	50,5	35,6	35	●	
		3/4"	50,5	35,6	35	●	
	51 mm	1"	50,5	35,6	35	●	
		1/2"	64,0	47,6	35	●	
		3/4"	64,0	47,6	40	●	
		1"	64,0	47,6	40	●	
		1 1/4"	64,0	47,6	40	●	
	63,5 mm	1 1/2"	64,0	47,6	40	●	
		2"	64,0	47,6	45	●	
		2 1/2"	77,5	60,3	45	●	
	76,1 mm	3"	91,0	72,9	50	●	
	101,6 mm	4"	119,0	97,6	55	●	

● = Sandėliuojama

○ = Užsakoma

pardavimai@busgeriau.lt +37066276762

04 Antgaliai & Užspaudėjai



Užspaudimo antgaliai

Busgeriau nr.

vidinis BSPP sriegis

9868

Tinka užspaudimo antgaliai		Vidinis sriegis	Išmatavimai (mm)			AISI 316L
DS/SMS	MINI	BSPP	Flanšas D	Vidus B	Ilgis L	
	10 mm	1/8"	25,4	8,0	25	●
	12 mm	1/4"	25,4	10,0	25	●
	18 mm	1/4"	25,4	16,0	25	●
		3/8"	25,4	16,0	25	●
	25 mm	1/2"	25,4	16,0	25	●
		1/4"	50,5	22,6	25	●
		3/8"	50,5	22,6	25	●
		1/2"	50,5	22,6	25	●
	38 mm	3/4"	50,5	22,6	25	●
		1"	50,5	22,6	25	●
		1/4"	50,5	35,6	35	●
		3/8"	50,5	35,6	30	●
		1/2"	50,5	35,6	30	●
	51 mm	3/4"	50,5	35,6	30	●
		1"	50,5	35,6	35	●
		1 1/4"	50,5	35,6	35	●
	63,5 mm	1 1/2"	50,5	35,6	35	●
		1/2"	64,0	47,6	35	●
		3/4"	64,0	47,6	30	●
		1"	64,0	47,6	35	●
	76,1 mm	1 1/4"	64,0	47,6	35	●
		1 1/2"	64,0	47,6	25	●
		2"	64,0	47,6	35	●
	101,6 mm	2 1/2"	77,5	60,3	35	●
		3"	91,0	72,9	40	●
		4"	119,0	97,6	50	●

● = Sandėliuojama ○ = Užsakoma pardavimai@busgeriau.lt +37066276762

04 Antgaliai & Užspaudėjai

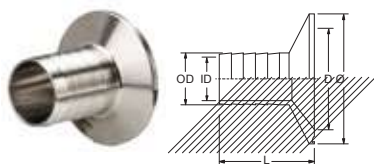

Užspaudimo antgaliai Su žarnos antgaliumi

Busgeriau nr.

9869

Tinka užspaudimo antgaliai		Išmatavimai (mm)					AISI 316L
DS/SMS	MINI	Antgalio ID	Antgalio VD	Flanšas Ø	Flanšas D	Ilgis L	
	12 mm	6,4	3,4	25,4	10,0	32	○
		9,5	6,5	25,4	10,0	32	○
		12,7	9,7	25,4	10,0	32	●
	18 mm	6,4	3,4	25,4	16,0	32	○
		9,5	6,5	25,4	16,0	32	○
		12,7	9,7	25,4	16,0	32	●
		19,0	16,0	25,4	16,0	32	●
25 mm		6,4	3,4	50,5	22,5	40	○
		9,5	6,5	50,5	22,5	40	○
		12,7	9,7	50,5	22,5	40	○
		19,0	16,0	50,5	22,5	40	●
		26,0	23,0	50,5	22,5	40	●
38 mm		6,4	3,4	50,5	35,0	40	○
		9,5	6,5	50,5	35,0	40	○
		12,7	9,7	50,5	35,0	40	○
		19,0	16,0	50,5	35,0	40	○
		26,0	23,0	50,5	35,0	40	●
		38,1	35,0	50,5	35,0	40	●
51 mm		12,7	9,7	64,0	47,6	60	○
		19,0	16,0	64,0	47,6	60	○
		26,0	23,0	64,0	47,6	60	○
		38,1	35,0	64,0	47,6	60	●
		50,8	47,0	64,0	47,6	60	●
63,5 mm		63,5	60,5	77,5	60,5	60	○
76,1 mm		77,1	72,1	91,0	72,1	70	○
101,6 mm		101,6	97,6	119,0	97,6	86,5	○

● = Sandėliuojama ○ = Užsakoma

pardavimai@busgeriau.lt +37066276762

04 Antgaliai & Užspaudėjai



9864

Užspaudimo aklė

Busgeriau nr.

vamzdžio (mm)			Flanšas Ø mm	T mm	316L
DS/SMS	DIN	ISO			
	6-18 (mini)	13,5-17,2	25,4	6	●
	13-23		34,0	6	●
25-38	29-41	21,3-33,7	50,5	7	●
51	53	42,4-48,3	64,0	7	●
63,5		60,3	77,5	7	●
76,1	70	76,1	91,0	7	●
	85	88,9	106,0	7	●
101,6	104		119,0	8	●
		114,3	130,0	8	●
	129		144,0	8	●
	129	139,7	155,0	8	●
	154		167,0	11	●
	154	168,3	183,0	11	●
	204		218,0	11	●
	204	219,1	233,5	11	●
	254		268,0	11	●
		273,0	286,0	11	●
	304		319,0	11	●
		323,9	338,5	11	●

● = Sandėliuojama ○ = Užsakoma pardavimai@busgeriau.lt +37066276762

05 Flanšai

05 Flanšai



Tarpinės DIN 2690 / EN 1514-1

Busgeriau nr.

Flanšas	Slėgis	Tarpinė D x d		Storis				A-NBR	6090U	EPDM	6090ES	Graphite-6090G	EPDM	6090E	PTFE	6090T	Silikonas	6090S
		Plokščia su plienu		A-NBR	EPDM	Grafitas	FDA											
DN15	PN 10-40	50 x 22		1,5	4,0	2,0	2,0	●	●	●	●	●	●	●	●	●	●	
DN20	PN 10-40	60 x 28		1,5	4,0	2,0	2,0	●	●	●	●	●	●	●	●	●	●	
DN25	PN 10-40	70 x 35		1,5	4,0	2,0	2,0	●	●	●	●	●	●	●	●	●	●	
DN32	PN 10-40	82 x 43		1,5	4,0	2,0	2,0	●	●	●	●	●	●	●	●	●	●	
DN40	PN 10-40	92 x 49		1,5	4,0	2,0	2,0	●	●	●	●	●	●	●	●	●	●	
DN50	PN 10-40	107 x 61		1,5	4,0	2,0	2,0	●	●	●	●	●	●	●	●	●	●	
DN65	PN 10-40	127 x 77		1,5	4,0	2,0	2,0	●	●	●	●	●	●	●	●	●	●	
DN80	PN 10-40	142 x 90	142 x 89	1,5	4,0	2,0	2,0	●	●	●	●	●	●	●	●	●	●	
DN100	PN 10-16	162 x 115		1,5	5,0	2,0	2,0	●	●	●	●	●	●	●	●	●	●	
DN125	PN 10-16	192 x 141		1,5	5,0	2,0	2,0	●	●	●	●	●	●	●	●	●	●	
DN150	PN 10-16	218 x 169		1,5	5,0	2,0	2,0	●	●	●	●	●	●	●	●	●	●	
DN200	PN 10-16	273 x 220		1,5	6,0	2,0	2,0	●	●	●	●	●	●	●	●	●	●	
DN250	PN 10	330 x 274	328 x 274	1,5	6,0	2,0	2,0	●	●	●	●	○	○	○	○	○	○	
DN300	PN 10	385 x 325	378 x 324	1,5	6,0	2,0	2,0	●	●	●	●	○	○	○	○	○	○	
DN350	PN 10	445 x 368	438 x 356	1,5	7,0	2,0	2,0	●	●	●	●	○	○	○	○	○	○	
DN400	PN 10	490 x 420	489 x 407	1,5	7,0	2,0	2,0	●	●	●	●	○	○	○	○	○	○	
DN450	PN 10	540 x 470	539 x 458	1,5	7,0	2,0	2,0	●	●	○	○	○	○	○	○	○	○	
DN500	PN 10	595 x 520	594 x 508	1,5	7,0	2,0	2,0	●	●	○	○	○	○	○	○	○	○	
DN600	PN 10	696 x 620	695 x 610	1,5	7,0	2,0	2,0	●	●	○	○	○	○	○	○	○	○	

● = Sandėliuojama ○ = keletas dienų pristatymas

Tarpinės su spec. Išmatavimais ar su skylėmis varžtams patiekiamos per kelias dienas.

Busgeriau nr.

6090U -NBR

Sertifikatai

BAM (Deguonis), DIN-DVGW DIN 3535-6, SVGW 3535-6, DVGW VP 401, DVGW KTW, DVGW W270, TA-Luft (VDI 440), WRAS, Germanische Lloyd ir ABS EC 1935/2004 category 4, AGA 8140 G (Class III).

6090ES - EPDM su metalu

KTW (geriamas vanduo) ir W270

6090G - Grafito laminatas

BAM (Deguonis), DIN-DVGW DIN 3535-6, DVGW VP 401, DVGW KTW, Germanische Lloyd ir API 607

6090E - EPDM, FDA

FDA, 3-A higieniniai standartai cl. III, EU1935/2004 ir EU2023/2006

6090T - PTFE, FDA

FDA, TA-Luft, Germanische Lloyd, ABS, EU1935/2004 ir EU2023/2006

6090S - Silikonas, FDA

FDA, EU1935/2004 ir EU2023/2006

05 Flanšai

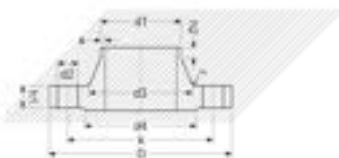

Flanšai su virinamu kaklu EN 1092-1, Tipas 11B

Nom. srg.	d1 mm	Slėgis	Flanšas				Kaklas				Tarpinė		Varžtai		Busgeriau nr.	EN 1.4307 EN 1.4404	
			D mm	b mm	k mm	h1	d3	s mm	r mm	h2 mm	d4 mm	f	vnt.	Sr. M.			d2 mm
DN 15	21,3	PN10/16/25/40	95	16	65	38	32	2,0	4	6	45	2	4	12	14	6035	● ●
DN 20	26,9	PN10/16/25/40	105	18	75	40	40	2,3	4	6	58	2	4	12	14	6035	● ●
DN 25	33,7	PN10/16/25/40	115	18	85	40	46	2,6	4	6	68	2	4	12	14	6035	● ●
DN 32	42,4	PN10/16/25/40	140	18	100	42	56	2,6	6	6	78	2	4	16	18	6035	● ●
DN 40	48,3	PN10/16/25/40	150	18	110	45	64	2,6	6	7	88	3	4	16	18	6035	● ●
DN 50	57,0	PN10/16	165	18	125	45	74	2,9	6	8	102	3	4	16	18	6030	○ ●
DN 50	60,3	PN10/16	165	18	125	45	74	2,9	6	8	102	3	4	16	18	6030	● ●
DN 65	76,1	PN10/16	185	18	145	45	92	2,9	6	10	122	3	8	16	18	6030	● ●
DN 65-4h	76,1	PN10/16	185	18	145	45	92	2,9	6	10	122	3	4	16	18	6030	○ ●
DN 80	88,9	PN10/16	200	20	160	50	105	3,2	8	10	138	3	8	16	18	6030	● ●
DN 100	114,3	PN10/16	220	20	180	52	131	3,6	8	12	158	3	8	16	18	6030	● ●
DN 125	139,7	PN10/16	250	22	210	55	156	4,0	8	12	188	3	8	16	18	6030	● ●
DN 150	168,3	PN10/16	285	22	240	55	184	4,5	10	12	212	3	8	20	22	6030	● ●
DN 50	60,3	PN25/40	165	20	125	48	75	2,9	6	8	102	3	4	16	18	6035	● ●
DN 65	76,1	PN25/40	185	22	145	52	90	2,9	6	10	122	3	8	16	18	6035	○ ●
DN 80	88,9	PN25/40	200	24	160	58	105	3,2	8	12	138	3	8	16	18	6035	○ ●
DN 100	114,3	PN25/40	235	24	190	65	134	3,6	8	12	162	3	8	20	22	6035	○ ●
DN 125	139,7	PN25/40	270	26	220	68	162	4,0	8	12	188	3	8	24	26	6035	○ ●
DN 150	168,3	PN25/40	300	28	250	75	192	4,5	10	12	218	3	8	24	26	6035	○ ●
DN 200	219,1	PN 10	340	24	295	62	234	6,3	10	16	268	3	8	20	22	6029	● ●
DN 250	273,0	PN 10	395	26	350	68	292	6,3	12	16	320	3	12	20	22	6029	● ●
DN 300	323,9	PN 10	445	26	400	68	342	7,1	12	16	370	4	12	20	22	6029	● ●
DN 350	355,6	PN 10	505	26	460	68	385	7,1	12	16	430	4	16	20	22	6029	● ●
DN 400	406,4	PN 10	565	26	515	72	440	7,1	12	16	482	4	16	24	26	6029	● ●
DN 200	219,1	PN16	340	24	295	62	235	6,3	10	16	268	3	12	20	22	6030	● ●
DN 250	273,0	PN16	405	26	355	70	292	6,3	12	16	320	3	12	24	26	6030	● ●
DN 300	323,9	PN16	460	28	410	78	344	7,1	12	16	378	4	12	24	26	6030	● ●
DN 350	355,6	PN16	520	30	470	82	390	8,0	12	16	438	4	16	24	26	6030	● ●
DN 400	406,4	PN16	580	32	525	85	445	8,0	12	16	490	4	16	27	30	6030	● ●

● = Sandėliuojama ○ = Užsakoma pardavimai@busgeriau.lt + 37066276762

05 Flanšai

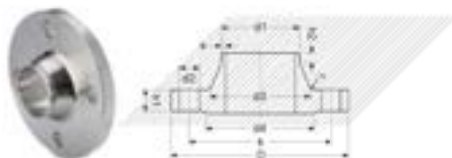

Flanšai virinamu kaklu EN 1092-1, Tipas 11B

Nom. srg.	d1 mm	Slėgis	Flanšas				Kaklas				Tarpinė d4 f vnt.	Varžtai Sr. d2 M. mm	Busger nr.	EN 1.4307	EN 1.4404	
			D mm	b mm	k mm	h1	d3	s	r	h2						
DIN / Metrinis																
DN 20	25,0	PN10/16/25/40	105	18	75	40	40 1,5	4	6	58 2	4	12	14	6035	○	●
DN 32	35,0	PN10/16/25/40	140	18	100	42	56 1,5	6	6	78 2	4	16	18	6035	○	●
DN 32	38,0	PN10/16/25/40	140	18	100	42	56 1,5	6	6	78 2	4	16	18	6035	○	●
DN 40	44,5	PN10/16/25/40	150	18	110	45	64 2,0	6	7	88 3	4	16	18	6035	○	●
DN 50	54,0	PN10/16	165	18	125	45	74 2,0	6	8	102 3	4	16	18	6030	○	●
DN 65-4h	70,0	PN10/16	185	18	145	45	92 2,0	6	10	122 3	4	16	18	6030	○	●
DN 65	70,0	PN10/16	185	18	145	45	92 2,0	6	10	122 3	8	16	18	6030	○	●
DN 80	84,0	PN10/16	200	20	160	50	105 2,0	8	10	138 3	8	16	18	6030	○	●
DN 100	104,0	PN10/16	220	20	180	52	131 2,0	8	12	158 3	8	16	18	6030	○	●
DN 125	129,0	PN10/16	250	22	210	55	156 2,0	8	12	188 3	8	16	18	6030	○	●
DN 150	154,0	PN10/16	285	22	240	55	184 2,0	10	12	212 3	8	20	22	6030	○	●
DN 200	204,0	PN10	340	24	295	62	234 2,0	10	16	268 3	8	20	22	6029	○	●
DN 200	206,0	PN10	340	24	295	62	234 3,0	10	16	268 3	8	20	22	6029	○	●
DN 250	256,0	PN10	395	26	350	68	292 3,0	12	16	320 3	12	20	22	6029	○	●
DN 300	306,0	PN10	445	26	400	68	342 3,0	12	16	370 4	12	20	22	6029	○	●

● = Sandėliuojama ○ = Užsakoma pardavimai@busgeriau.lt +37066276762

05 Flanšai

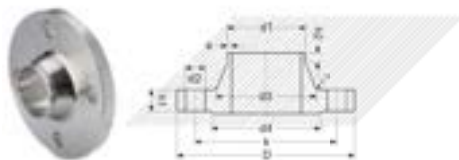

Flanšai virinamu kaklu

EN 1092-1, Tipas 11B

Nom. srg.	d1 mm	Slėgis	Flanšas				Kaklas				Tarpinė		Varžtai		Busgeriau nr.	EN 1.4307	EN 1.4404	
			D mm	b mm	k mm	h1 mm	d3 mm	s mm	r mm	h2 mm	d4 mm	f mm	vnt.	Sr. M. mm				d2 mm
DN 20	25,0	PN 10/16/25/40	105	18	75	40	40 1,5	4	6	58	2	4	12	14	6035	○ ●		
DN 32	38,0	PN 10/16/25/40	140	18	100	42	56 1,5	6	6	78	2	4	16	18	6035	○ ●		
DN 50	51,0	PN 10/16	165	18	125	45	74 1,5	6	8	102	3	4	16	18	6030	○ ●		
DN 65	63,5	PN 10/16	185	18	145	45	92 2,0	6	10	122	3	4	16	18	6030	○ ●		
DN 65	76,1	PN 10/16	185	18	145	45	92 2,0	6	10	122	3	8	16	18	6030	○ ●		
DN 100	101,6	PN 10/16	220	20	180	52	131 2,0	8	12	158	3	8	16	18	6030	○ ●		

DS/SMS

DIN 11850

DN 10	13,0	PN10/16/25/40	90	16	60	35	28 1,5	4	6	40	2	4	12	14	6035	○ ●		
DN 15	19,0	PN10/16/25/40	95	16	65	38	32 1,5	4	6	45	2	4	12	14	6035	○ ●		
DN 20	23,0	PN10/16/25/40	105	18	75	40	40 1,5	4	6	58	2	4	12	14	6035	○ ●		
DN 25	29,0	PN10/16/25/40	115	18	85	40	46 1,5	4	6	68	2	4	12	14	6035	○ ●		
DN 32	35,0	PN10/16/25/40	140	18	100	42	56 1,5	6	6	78	2	4	16	18	6035	○ ●		
DN 40	41,0	PN10/16/25/40	150	18	110	45	64 1,5	6	7	88	3	4	16	18	6035	○ ●		
DN 50	53,0	PN10/16	165	18	125	45	74 1,5	6	8	102	3	4	16	18	6030	○ ●		
DN 65-4h	70,0	PN10/16	185	18	145	45	92 2,0	6	10	122	3	4	16	18	6030	○ ●		
DN 65	70,0	PN10/16	185	18	145	45	92 2,0	6	10	122	3	8	16	18	6030	○ ●		
DN 80	85,0	PN10/16	200	20	160	50	105 2,0	8	10	138	3	8	16	18	6030	○ ●		
DN 100	104,0	PN10/16	220	20	180	52	131 2,0	8	12	158	3	8	16	18	6030	○ ●		
DN 125	129,0	PN10/16	250	22	210	55	156 2,0	8	12	188	3	8	16	18	6030	○ ●		
DN 150	154,0	PN10/16	285	22	240	55	184 2,0	10	12	212	3	8	20	22	6030	○ ●		
DN 200	204,0	PN10	340	24	295	62	234 2,0	10	16	268	3	8	20	22	6029	○ ●		

● = Sandėliuojama ○ = Užsakoma pardavimai@busgeriau.lt +37066276762

05 Flanšai

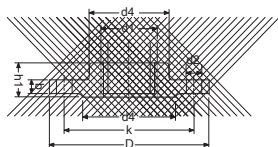

Flanšai Srieginiai

EN 1092-1, Tipas 13B

Nom. srg.	d1 mm ≈	Slėgis	Flanšas				Kaklas Tarpinė			Varžtai		Busgeriau nr.	EN 1.4307	EN 1.4404	
			D mm	b mm	k mm	h1 mm	d3 mm	d4 mm	f mm	vnt.	M				d2 mm
1/2"	21,3	PN10/16/25/40	95	16	65	22	35	45	2	4	12	14	6010	○	●
3/4"	26,9	PN10/16/25/40	105	16	75	26	45	58	2	4	12	14	6010	○	●
1"	33,7	PN10/16/25/40	115	18	85	28	52	68	2	4	12	14	6010	○	●
1 1/4"	42,4	PN10/16/25/40	140	18	100	30	60	78	2	4	16	18	6010	○	●
1 1/2"	48,3	PN10/16/25/40	150	18	110	32	70	88	3	4	16	18	6010	○	●
2"	60,3	PN10/16	165	18	125	28	85	102	3	4	16	18	6010	○	●
2 1/2"	76,1	PN10/16	185	18	145	32	105	122	3	8	16	18	6010	○	●
3"	88,9	PN10/16	200	20	160	34	118	138	3	8	16	18	6010	○	●
4"	114,3	PN10/16	220	20	180	40	140	158	3	8	16	18	6010	○	●

■ = Sandėliuojama ○ = Užsakoma

pardavimai@busgeriau.lt +37066276762

Pjovimas vandeniu

Storis iki 150 mm

Diametras iki 2000 mm

Pjovimas plazma

Storis iki 150 mm

Diametras iki 2500 mm

05 Flanšai

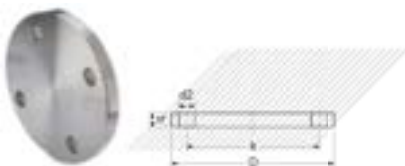

Flanšai aklės

EN 1092-1, Tipas 05A

Nom. srg.	Slėgis	Flanšas			vnt.	Varžtai			Busgeriau nr.	EN 1.4307	EN 1.4404
		D mm	b mm	k mm		M	d2 mm				
DN 15	PN10/16/25/40	95	16	65	4	12	14	6006	●	●	
DN 20	PN10/16/25/40	105	18	75	4	12	14	6006	●	●	
DN 25	PN10/16/25/40	115	18	85	4	12	14	6006	●	●	
DN 32	PN10/16/25/40	140	18	100	4	16	18	6006	●	●	
DN 40	PN10/16/25/40	150	18	110	4	16	18	6006	●	●	
DN 50	PN10/16	165	18	125	4	16	18	6000	●	●	
DN 65	PN10/16	185	18	145	8	16	18	6000	●	●	
DN 65 - 4 h.	PN10/16	185	18	145	4	16	18	6000	○	●	
DN 80	PN10/16	200	20	160	8	16	18	6000	●	●	
DN 100	PN10/16	220	20	180	8	16	18	6000	●	●	
DN 125	PN10/16	250	22	210	8	16	18	6000	●	●	
DN 150	PN10/16	285	22	240	8	20	22	6000	●	●	
DN 50	PN25/40	165	20	125	4	16	18	6006	○	●	
DN 65	PN25/40	185	22	145	8	16	18	6006	○	●	
DN 80	PN25/40	200	24	160	8	16	18	6006	○	●	
DN 100	PN25/40	235	24	190	8	20	22	6006	○	●	
DN 125	PN25/40	270	26	220	8	24	26	6006	○	●	
DN 150	PN25/40	300	28	250	8	24	26	6006	○	●	
DN 200	PN10	340	24	295	8	20	22	6005	●	●	
DN 250	PN10	395	26	350	12	20	22	6005	●	●	
DN 300	PN10	445	26	400	12	20	22	6005	●	●	
DN 350	PN10	505	26	460	16	20	22	6005	●	●	
DN 400	PN10	565	26	515	16	24	26	6005	●	●	
DN 200	PN16	340	24	295	12	20	22	6000	●	●	
DN 250	PN16	405	26	355	12	24	26	6000	○	●	
DN 300	PN16	460	28	410	12	24	26	6000	○	●	
DN 350	PN16	520	30	470	16	24	26	6000	○	●	
DN 400	PN16	580	32	525	16	27	30	6000	○	●	

● = Sandėliuojama ○ = Užsakoma

pardavimai@busgeriau.lt +37066276762

05 Flanšai

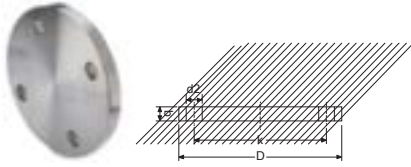

Flanšai akls, redukcinio storio

EN 1092-1, Tipas 05A

Busgeriau nr.

Nom. srg.	Išmatavimai pagal	Flanšas			Varžtai			Busgeriau nr.	EN 1.4307	EN 1.4404
		D mm	b mm	k mm	Qy.	M	d2 mm			
DN 50	PN10	165	10	125	4	16	18	6000	○	●
DN 65	PN10	185	10	145	8	16	18	6000	○	●
DN 65 - 4 h.	PN10	185	10	145	4	16	18	6000	○	●
DN 80	PN10	200	10	160	8	16	18	6000	○	●
DN 100	PN10	220	10	180	8	16	18	6000	○	●
DN 125	PN10	250	12	210	8	16	18	6000	○	●
DN 150	PN10	285	12	240	8	20	22	6000	○	●
DN 200	PN10	340	12	295	8	20	22	6000	○	●
DN 250	PN10	395	15	350	12	20	22	6000	○	●
DN 300	PN10	445	15	400	12	20	22	6000	○	●
DN 350	PN10	505	15	460	16	20	22	6000	○	●
DN 400	PN10	565	15	515	16	24	26	6000	○	●
DN 500	PN10	670	15	620	20	24	26	6000	○	●
DN 600	PN10	780	20	725	20	27	30	6000	○	●

05 Flanšai

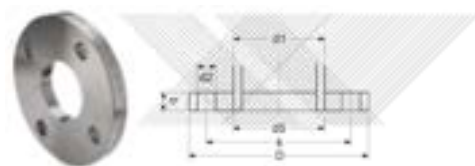

Plokščia welding Flanšai

EN 1092-1, Tipas 01A

Nom. srg.	d1 mm	Slėgis	Flanšas				Varžtai			Busgeriau	EN	EN ⁴
			d5 mm	D mm	b mm	k mm	vnt.	M	d2 mm			
ISO												
DN 40	48,3	PN6	49,5	130	16	100	4	12	14	6015	○	●
DN 50	60,3	PN6	61,5	140	16	110	4	12	14	6015	○	●
DN 65	76,1	PN6	77,5	160	16	130	4	12	14	6015	○	●
DN 80	88,9	PN6	90,5	190	18	150	4	16	18	6015	○	●
DN 100	114,3	PN6	116,0	210	18	170	4	16	18	6015	○	●
DN 125	139,7	PN6	141,5	240	20	200	8	16	18	6015	○	●
DN 150	168,3	PN6	170,5	265	20	225	8	16	18	6015	○	●
DN 200	219,1	PN6	221,5	320	22	280	8	16	18	6015	○	●
DN 15	21,3	PN10/16/25/40	22,0	95	14	65	4	12	14	6020	●	●
DN 20	26,9	PN10/16/25/40	27,5	105	16	75	4	12	14	6020	●	●
DN 25	33,7	PN10/16/25/40	34,5	115	16	85	4	12	14	6020	●	●
DN 32	42,4	PN10/16/25/40	43,5	140	18	100	4	16	18	6020	●	●
DN 40	48,3	PN10/16/25/40	49,5	150	18	110	4	16	18	6020	●	●
DN 50	60,3	PN10/16	61,5	165	20	125	4	16	18	6020	●	●
DN 65	76,1	PN10/16	77,5	185	20	145	8	16	18	6020	●	●
DN 65-4h	76,1	PN10/16	77,5	185	20	145	4	16	18	6020	○	●
DN 80	88,9	PN10/16	90,5	200	20	160	8	16	18	6020	●	●
DN 100	114,3	PN10/16	116,0	220	22	180	8	16	18	6020	●	●
DN 125	139,7	PN10/16	141,5	250	22	210	8	16	18	6020	●	●
DN 150	168,3	PN10/16	170,5	285	24	240	8	20	22	6020	●	●
DN 200	219,1	PN10	221,5	340	24	295	8	20	22	6020	●	●
DN 200	219,1	PN16	221,5	340	26	295	12	20	22	6020	●	●
DN 250	273,0	PN10	276,5	395	26	350	12	20	22	6020	●	●
DN 300	323,9	PN10	327,5	445	26	400	12	20	22	6020	●	●
DN 350	355,6	PN10	359,5	505	30	460	16	20	22	6020	●	●
DN 400	406,4	PN10	411,0	565	32	515	16	24	26	6020	●	●

● = Sandėliuojama

○ = Užsakoma

pardavimai@busgeriau.lt +37066276762

05 Flanšai

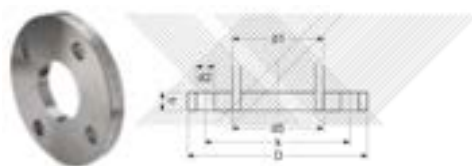

Plokšti virinami flanšai

EN 1092-1, Tipas 01A

Nom. srg.	d1 mm	Slėgis	Flanšas				Varžtai			Busgeriau n	EN 1.43071	EN 1.4404 ⁴
			d5 mm	D mm	b mm	k mm	vnt.	M	d2 mm			
DIN / Metrinis												
DN 20	25,0	PN10/16/25/40	26,0	105	16	75	4	12	14	6025	○	●
DN 25	30,0	PN10/16/25/40	31,0	115	16	85	4	12	14	6025	○	●
DN 32	35,0	PN10/16/25/40	36,0	140	18	100	4	16	18	6025	○	●
DN 32	38,0	PN10/16/25/40	39,0	140	18	100	4	16	18	6025	○	●
DN 40	44,5	PN10/16/25/40	45,5	150	18	110	4	16	18	6025	○	●
DN 50	54,0	PN10/16	55,0	165	20	125	4	16	18	6025	○	●
DN 65	70,0	PN10/16	71,0	185	20	145	4	16	18	6025	○	●
DN 80	84,0	PN10/16	85,5	200	20	160	8	16	18	6025	○	●
DN 100	104,0	PN10/16	105,5	220	22	180	8	16	18	6025	○	●
DN 125	129,0	PN10/16	130,5	250	22	210	8	16	18	6025	○	●
DN 150	154,0	PN10/16	155,5	285	24	240	8	20	22	6025	○	●
DN 200	204,0	PN10	205,5	340	24	295	8	20	22	6025	○	●
DN 200	206,0	PN10	207,5	340	24	295	8	20	22	6025	○	●
DN 250	254,0	PN10	257,0	395	26	350	12	20	22	6025	○	●
DN 250	256,0	PN10	259,0	395	26	350	12	20	22	6025	○	●
DN 300	304,0	PN10	307,0	445	26	400	12	20	22	6025	○	●
DN 300	306,0	PN10	309,0	445	26	400	12	20	22	6025	○	●

● = Sandėliuojama ○ = Užsakoma pardavimai@busgeriau.lt +37066276762

05 Flanšai

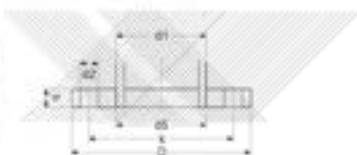

Plokšti virinami flanšai

EN 1092-1, Tipas 01A

Nom. srg.	d1 mm	Slėgis	Flanšas				Varžtai			Busgeriau nr	EN 1.43071.4404	EN
			d5 mm	D mm	b mm	k mm	vnt.	M	d2 mm			
DN 20	25,0	PN10/16/25/40	26,0	105	16	75	4	12	14	6025	○	●
DN 32	38,0	PN10/16/25/40	39,0	140	18	100	4	16	18	6025	○	●
DN 50	51,0	PN 10/16	52,0	165	20	125	4	16	18	6025	○	●
DN 65	63,5	PN 10/16	64,5	185	20	145	4	16	18	6025	○	●
DN 65-4h	76,1	PN 10/16	77,5	185	20	145	4	16	18	6020	○	●
DN 65	76,1	PN 10/16	77,5	185	20	145	8	16	18	6020	●	●
DN 100	101,6	PN 10/16	102,6	220	22	180	8	16	18	6025	○	●

DIN 11850

DN 15	19,0	PN10/16/25/40	20,0	95	14	65	4	12	14	6025	○	●
DN 20	23,0	PN10/16/25/40	24,0	105	16	75	4	12	14	6025	○	●
DN 25	29,0	PN10/16/25/40	30,0	115	16	85	4	12	14	6025	○	●
DN 32	35,0	PN10/16/25/40	36,0	140	18	100	4	16	18	6025	○	●
DN 40	41,0	PN10/16/25/40	42,0	150	18	110	4	16	18	6025	○	●
DN 50	53,0	PN10/16	54,0	165	20	125	4	16	18	6025	○	●
DN 65	70,0	PN10/16	71,5	185	20	145	4	16	18	6025	○	●
DN 80	85,0	PN10/16	85,5	200	20	160	8	16	18	6025	○	●
DN 100	104,0	PN10/16	105,5	220	22	180	8	16	18	6025	○	●
DN 125	129,0	PN10/16	130,5	250	22	210	8	16	18	6025	○	●
DN 150	154,0	PN10/16	155,5	285	24	240	8	20	22	6025	○	●
DN 200	204,0	PN10	205,5	340	24	295	8	20	22	6025	○	●

● = Sandėliuojama

○ = Užsakoma

pardavimai@busgeriau.lt +37066276762

05 Flanšai



Plokšti virinami flanšai, redukcinio storio

EN.1092-1, Tipas 01A

Nom. srg.	d1 mm	Išmatavimai pagal	Flanšas				Varžtai			Busgeriau		
			d5 mm	D mm	b mm	k mm	vnt.	M	d2 mm	EN 1.43071	EN 1.4404	
DN 50	60,3	PN10	61,5	165	10	125	4	16	18	6020	•	•
DN 65	76,1	PN10	77,5	185	10	145	8	16	18	6020	•	•
DN 65-4h	76,1	PN10	77,5	185	10	145	4	16	18	6020	○	•
DN 80	88,9	PN10	90,5	200	10	160	8	16	18	6020	•	•
DN 100	114,3	PN10	116,0	220	10	180	8	16	18	6020	•	•
DN 125	139,7	PN10	141,5	250	12	210	8	16	18	6020	•	•
DN 150	168,3	PN10	170,5	285	12	240	8	20	22	6020	•	•
DN 200	219,1	PN10	221,5	340	12	295	8	20	22	6020	•	•
DN 250	273,0	PN10	276,5	395	15	350	12	20	22	6020	•	•
DN 300	323,9	PN10	327,5	445	15	400	12	20	22	6020	•	•
DN 350	355,6	PN10	359,5	505	15	460	16	20	22	6020	•	•
DN 400	406,4	PN10	411,0	565	15	515	16	24	26	6020	•	•
DN 500	508,0	PN10	513,5	670	15	620	20	24	26	6020	○	•
DN 600	609,6	PN10	616,5	780	20	725	20	27	30	6020	○	•

DIN / Metrinis

DN 100	104,0	PN10	105,5	220	10	180	8	16	18	6025	○	•
DN 125	129,0	PN10	130,5	250	10	210	8	16	18	6025	○	•
DN 150	154,0	PN10	155,5	285	12	240	8	20	22	6025	○	•
DN 200	204,0	PN10	205,5	340	12	295	8	20	22	6025	○	•
DN 250	254,0	PN10	257,0	395	15	350	12	20	22	6025	○	•

05 Flanšai

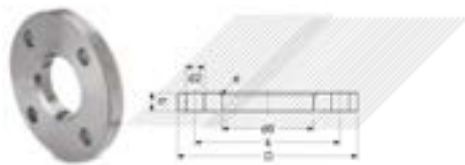

Laisvi flanšai

EN 1092-1, Tipas 02A

Nom. srg.	d1 mm	Slėgis	Flanšas					Varžtai			Busgeriau nr.	EN	EN		
			D mm	d6 mm	b mm	k mm	e mm	vnt.	M	d2 mm				1.43071	4.4404
ISO															
DN 15	21,3	PN10/16/25/40	95	25	14	65	3	4	12	14	6040	●	●		
DN 20	26,9	PN10/16/25/40	105	31	14	75	4	4	12	14	6040	●	●		
DN 25	33,7	PN10/16/25/40	115	38	16	85	4	4	12	14	6040	●	●		
DN 32	42,4	PN10/16/25/40	140	47	18	100	5	4	16	18	6040	●	●		
DN 40	48,3	PN10/16/25/40	150	53	18	110	5	4	16	18	6040	●	●		
DN 50	60,3	PN10/16	165	65	20	125	5	4	16	18	6040	●	●		
DN 65	76,1	PN10/16	185	81	20	145	6	8	16	18	6040	●	●		
DN 65-4h	76,1	PN10/16	185	81	20	145	6	4	16	18	6040	○	●		
DN 80	88,9	PN10/16	200	94	20	160	6	8	16	18	6040	●	●		
DN 100	114,3	PN10/16	220	120	22	180	6	8	16	18	6040	●	●		
DN 125	139,7	PN10/16	250	145	22	210	6	8	16	18	6040	●	●		
DN 150	168,3	PN10/16	285	174	24	240	6	8	20	22	6040	●	●		
DN 200	219,1	PN10	340	226	24	295	6	8	20	22	6040	●	●		
DN 200	219,1	PN16	340	226	26	295	6	12	20	22	6040	●	●		
DN 250	273,0	PN10	395	281	26	350	8	12	20	22	6040	●	●		
DN 300	323,9	PN10	445	333	26	400	8	12	20	22	6040	●	●		
DN 350	355,6	PN10	505	365	30	460	8	16	20	22	6040	●	●		
DN 400	406,4	PN10	565	416	32	515	8	16	24	26	6040	●	●		

DIN / Metrinis

DN 50	54-56	PN10/16	165	62	20	125	5	4	16	18	6045	○	●
DN 65	70-71	PN10/16	185	78	20	145	6	8	16	18	6045	○	●
DN 80	84-86	PN10/16	200	92	20	160	6	8	16	18	6045	○	●
DN 100	104-106	PN10/16	220	112	22	180	6	8	16	18	6045	○	●
DN 125	129-131	PN10/16	250	138	22	210	6	8	16	18	6045	○	●
DN 150	154-156	PN10/16	285	164	24	240	6	8	20	22	6045	○	●
DN 200	204-206	PN10	340	214	24	295	6	8	20	22	6045	○	●
DN 250	254-256	PN10	395	264	26	350	8	12	20	22	6045	○	●
DN 300	304-306	PN10	445	314	26	400	8	12	20	22	6045	○	●

● = Sandėliuojama

○ = Užsakoma

pardavimai@busgeriau.lt +37066276762

05 Flanšai



Laisvi flanšai, redukcinio storio

EN 1092-1, Tipas 01A

Nom. srg.	d1 mm	Išmatavimai pagal	Flanšas					Varžtai			Busgeriau nr.	EN 1.43071.4404	EN 1.4404
			D mm	d6 mm	b mm	k mm	e mm	vnt.	M	d2 mm			
ISO													
DN 50	60,3	PN10	165	65	10	125	5	4	16	18	6040	●	●
DN 65	76,1	PN10	185	81	10	145	6	8	16	18	6040	●	●
DN 65-4h	76,1	PN10	185	81	10	145	6	4	16	18	6040	○	●
DN 80	88,9	PN10	200	94	10	160	6	8	16	18	6040	●	●
DN 100	114,3	PN10	220	120	10	180	6	8	16	18	6040	●	●
DN 125	139,7	PN10	250	145	12	210	6	8	16	18	6040	●	●
DN 150	168,3	PN10	285	174	12	240	6	8	20	22	6040	●	●
DN 200	219,1	PN10	340	226	12	295	6	8	20	22	6040	●	●
DN 250	273,0	PN10	395	281	15	350	8	12	20	22	6040	●	●
DN 300	323,9	PN10	445	333	15	400	8	12	20	22	6040	●	●
DN 350	355,6	PN10	505	365	15	460	8	16	20	22	6040	●	●
DN 400	406,4	PN10	565	416	15	515	8	16	24	26	6040	●	●
DN 500	508,0	PN10	670	519	15	620	8	20	24	26	6040	○	●
DN 600	609,6	PN10	780	622	20	725	8	20	27	30	6040	○	●

DIN / Metrinis

DN 100 104-106	PN10	220	112	10	180	6	8	16	18	6045	○	●
DN 125 129-131	PN10	250	138	12	210	6	8	16	18	6045	○	●
DN 150 154-156	PN10	285	164	12	240	6	8	20	22	6045	○	●
DN 200 204-206	PN10	340	214	12	295	6	8	20	22	6045	○	●
DN 250 254-256	PN10	395	264	15	350	8	12	20	22	6045	○	●
DN 300 304-306	PN10	445	314	15	400	8	12	20	22	6045	○	●

05 Flanšai

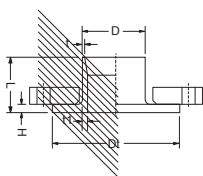

Virinamas žiedas su kaklu

EN1092-1, Tipas 35

Busgeriau nr. 6041

DN	D	Slėgis	Dt	t	t1	h	L	EN 1.4404
15	21,3	PN10/16/25/40	45	2	3	5	38	●
20	26,9	PN10/16/25/40	58	2	3	6	40	●
25	33,7	PN10/16/25/40	68	2	3	7	40	●
32	42,4	PN10/16/25/40	78	2	3	8	42	●
40	48,3	PN10/16/25/40	88	2	3	8	45	●
50	60,3	PN10/16	102	2	3	8	45	●
50	60,3	PN40	102	2,6	4	10	48	●
65	76,1	PN10/16	122	2	4	8	45	●
65	76,1	PN40	122	2,6	5	11	52	●
80	88,9	PN10/16	138	2	4	10	50	●
80	88,9	PN40	138	2,6	6	12	58	●
100	114,3	PN10/16	158	2	4	10	52	●
100	114,3	PN40	162	3,2	6	14	65	●
125	139,7	PN10/16	188	2	5	10	55	●
125	139,7	PN40	188	3,2	6	16	68	●
150	168,3	PN10/16	212	2	6	10	55	●
150	168,3	PN40	218	4	8	18	75	●
200	219,1	PN10/16	268	2,6	6	11	62	●
250	273,0	PN16	320	3,2	8	12	70	●
300	323,9	PN10	370	3,2	8	12	68	●
300	323,9	PN16	378	4	10	14	78	●
350	355,6	PN10	430	3,2	8	13	68	●
350	355,6	PN16	438	4	10	18	82	●
400	406,4	PN10	482	3,2	8	14	68	●
400	406,4	PN16	490	5	12	20	85	●

● = Sandėliuojama

○ = Užsakoma

pardavimai@busgeriau.lt + 37066276762

05 Flanšai

EN1092-1, Tipas 02A, PN10, su epoksidu splava RAL 7035

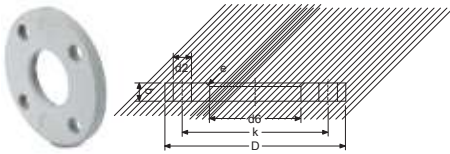

Laisvi flanšai, aluminiai

ISO

Nom. srg.	Išorinis Vam.diam.	D mm	Flanšas			vnt.	Varžtai		Busgeriau nr.
			d6 mm	b mm	k mm		Sriegis M.	d2 mm	
DN 15	21,3	95	24	12	65	4	12	14	6050
DN 20	26,9	105	30	12	75	4	12	14	6050
DN 25	33,7	115	36	12	85	4	12	14	6050
DN 32	42,4	140	46	16	100	4	16	18	6050
DN 40	48,3	150	54	16	110	4	16	18	6050
DN 50	60,3	165	65	16	125	4	16	18	6050
DN 65	76,1	185	81	16	145	4	16	18	6050
DN 80	88,9	200	94	18	160	8	16	18	6050
DN 100	114,3	220	119	18	180	8	16	18	6050
DN 125	139,7	250	145	18	210	8	16	18	6050
DN 150	168,3	285	173	18	240	8	20	22	6050
DN 200	219,1	340	225	20	295	8	20	22	6050
DN 250	273,0	395	279	22	350	12	24	26	6050
DN 300	323,9	445	329	22	400	12	24	26	6050

DIN / Metrinis

Nom. srg.	Išorinis Vam.diam.	D mm	Flanšas			vnt.	Varžtai		Busgeriau nr.
			d6 mm	b mm	k mm		Sriegis M.	d2 mm	
DN 32	38,0	140	42	16	100	4	16	18	6055
DN 40	44,5	150	48	16	110	4	16	18	6055
DN 50	54-56	165	60	16	125	4	16	18	6055
DN 65	70-71	185	75	16	145	4	16	18	6055
DN 80	84-86	200	90	18	160	8	16	18	6055
DN 100	104-106	220	111	18	180	8	16	18	6055
DN 125	129-131	250	136	18	210	8	16	18	6055
DN 150	154-156	285	161	18	240	8	20	22	6055
DN 200	204-206	340	212	20	295	8	20	22	6055
DN 250	254-256	395	264	22	350	12	20	22	6055
DN 300	304-306	445	315	22	400	12	20	22	6055
DN 350	356-358	505	362	22	460	16	20	22	6055
DN 400	406-408	565	413	25	515	16	24	26	6055
DN 450	456-458	615	465	25	565	20	24	26	6055
DN 500	506-508	670	517	28	620	20	24	26	6055
DN 600	606-610	780	618	30	725	20	28	30	6055

Visi išmatavimai sandėliuojami

pardavimai@busgeriau.lt + 37066276762

05 Flanšai

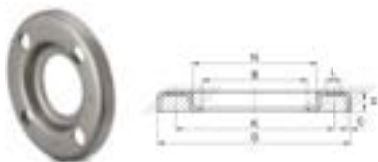

Presuoti laisvi flanšai

EN1092-1

ISO

Nom. srg.	Išorinis Vam.diam.	Slėgis	Flanšas					Varžtai		Busgeriau nr.	
			D mm	K mm	B mm	C mm	H mm	vnt.	L mm	6060	6065
DN 15	21,3	10/16	95	65	24	3	12	4	13,5	○	●
DN 20	26,9	10/16	105	75	30	3	14	4	13,5	●	●
DN 25	33,7	10/16	115	85	37	3	16	4	13,5	●	●
DN 32	42,4	10/16	140	100	46	3	16	4	17,5	●	●
DN 40	48,3	10/16	150	110	54	4	17,5	4	18	●	●
DN 50	60,3	10/16	165	125	65	4	19,5	4	18	●	●
DN 65	76,1	10/16	185	145	81	4	21,5	4	18	●	●
DN 80	88,9	10/16	200	160	94	4	21,5	8	18	●	●
DN 100	114,3	10/16	220	180	119	4	22	8	18	●	●
DN 125	139,7	10/16	250	210	145	5	22	8	18	●	●
DN 150	168,3	10/16	285	240	173	5	26	8	22	●	●
DN 200	219,1	10	340	295	225	6	28	8	22	●	●
DN 200	219,1	16	340	295	275	6	26	12	22	○	●
DN 250	273,0	10	395	350	279	6	31	12	22	●	●
DN 300	323,9	10	445	400	329	6	34	12	22	●	●

DIN / Metrinis

Nom. srg.	Išorinis Vam.diam.	Slėgis	Flanšas					Varžtai		Busgeriau nr.	
			D mm	K mm	B mm	C mm	H mm	vnt.	L mm	6060	6065
DN 40	44,5	10/16	150	110	48	4	17,5	4	18	●	●
DN 50	54-56	10/16	165	125	58	4	19,5	4	18	●	●
DN 65	70-71	10/16	185	145	78	4	21,5	4	18	●	●
DN 80	84-86	10/16	200	160	90	4	21,5	8	18	●	●
DN 100	104-106	10/16	220	180	110	4	22	8	18	●	●
DN 125	129-131	10/16	250	210	135	5	22	8	18	●	●
DN 150	154-150	10/16	285	240	160	5	26	8	22	●	●
DN 200	204-206	10	340	295	212	6	28	8	22	●	●
DN 200	204-206	16	340	295	212	6	26	12	22	○	●
DN 250	254-256	10	395	350	262	6	31	12	22	●	●
DN 300	304-306	10	445	400	312	6	34	12	22	●	●
DN 350	356-358	10	505	460	362	8	36	16	22	●	●
DN 400	406-408	10	565	515	413	8	38	16	26	●	●
DN 450	456-458	10	615	565	465	8	41	20	26	●	●
DN 500	506-408	10	670	620	517	8	41	20	26	●	●
DN 600	606-610	10	780	725	618	8	50	20	30	●	●

● = Sandėliuojama ○ = Užsakoma pardavimai@busgeriau.lt + 37066276762

05 Flanšai

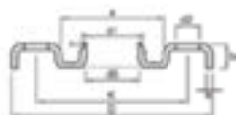

Presuojami virinamu kaklu flanšai EN1092-1, PN10

DIN / Metrinis

Flanšas

Varžtai

Busgeriau nr. 6080

Nom. srg.	d1 mm	D mm	K mm	a mm	e	b	h	vnt.	d2 mm	EN 1.4307	EN 1.4404
80	86	200	160	123	5	22	5	8	17,5	○	●
100	106	220	180	141	6	23	5	8	17,5	○	●
125	131	250	210	168	6	25	5	8	17,5	○	●
150	156	285	240	192	6	27	5	8	21,5	○	●
200	206	340	295	245	6	31	5	8	21,5	○	●
250	256	395	350	295	6	31	5	12	22	○	●
300	306	445	400	345	6	34	5	12	22	○	●
350	356	505	460	393	8	36	5	16	22	○	●
400	406	565	515	443	8	38	5	16	26	○	●

● = Sandėliuojama ○ = Užsakoma pardavimai@busgeriau.lt +37066276762

06 Sklendés

06 Rutulinės sklendės

1-dalies, DN 8-50

skylė: sumažinta
Slėgis: Maks. 65 bar

Tarpinė: PTFE
Galai: srieginiai



Modelis: TC

Busgeriau nr. 7017

DN	F	D	E	H	L
8	1/4"	5,0	60	31	39
10	3/8"	7,0	70	35	44
15	1/2"	9,2	86	43	56
20	3/4"	12,5	86	46	59
25	1"	16,0	104	50	71
32	1 1/4"	20,0	104	54	79
40	1 1/2"	24,5	126	65	83
50	2"	32,0	126	72	100

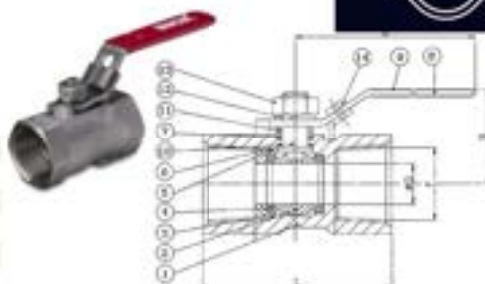

Modelis: Lengvas

Busgeriau nr. 7017L

DN	F	D	E	H	L
8	1/4"	5,0	70	30	39
10	3/8"	6,8	90	34	44
15	1/2"	9,2	100	41	56
20	3/4"	12,5	100	44	59
25	1"	15,0	110	50	71
32	1 1/4"	20,0	110	55	78
40	1 1/2"	25,0	135	64	83
50	2"	32,0	145	70	100

Nr.	Dalis	Medžiaga
1	Korpusas	CF8M
2	Rutulys	CF8M
3	Įdėklas	CF8M
4	Atrama	PTFE
5	Tarpinė	PTFE
6	Stėbas	AISI 316
7	Sėbio tarpinė	PTFE
8	Rankena	AISI 304
9	Rankenos dangs	Plastikas
10	Atraminė poveržlė	PTFE
11	Rankenos veržlė	AISI 304
12	Rankenos mova	AISI 304
13	Veržlė	AISI 304
14	Užraktas	AISI 304

Slėgio/temperatūra lentelė

Bar/cm2

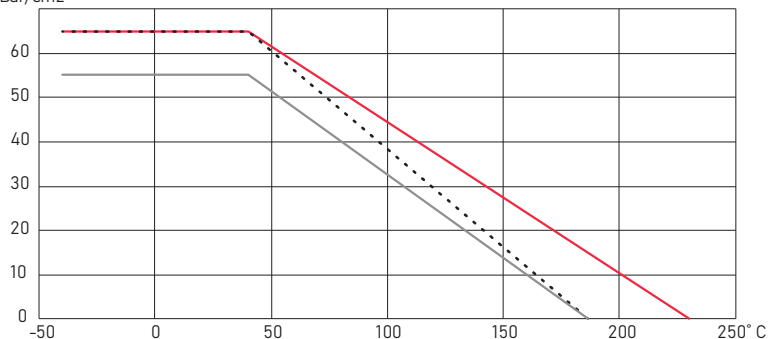

TC 7017

Visi dydžiai

7017L

1/4" - 1 1/4"

1 1/2" - 2"

Visi išmatavimai sandėliuojami

pardavimai@busgeriau.lt +37066276762

06 Rutulinės sklendės



Pagrindinė specifikacija

Korpusas ir dalys	Plienas CF8M/ASTM A 351 lygiavertis AISI 316/ASTM A 479
Tarpinės	PTFE+ GF = Teflonas su 15% stiklo pluoštu, Busgeriau nr. 7017
Rutulys	Iš karštai formuotos metalo AISI 316/ASTM A 479
Tarpinė	PTFE = teflon
Rankena	Nerūdijantis plienas su plastikine danga
Sriegiai	(BSPP) / ISO 228-1
Virinami galai	ISO 1127
Darbinė temperatūra	TC Modeliai: - 40 iki + 230° C Lengvi modeliai: -20 iki + 190° C
Bandymo slėgis	API 598 / EN 12266-1
Sertifikatai	EN 10204 3.1 ir PED 97/23/EC

06 Rutulinės sklendės

2-dalių, DN 8-100

Skylė: pilna

Tarpinė: PTFE + GF

Slėgis: Maks. 65 bar

Galai: srieginiai



Modelis: TC

Busgeriau nr. 7019

DN	F	D	E	H	L
8	1/4"	11,0	103	57	58
10	3/8"	12,5	103	57	58
15	1/2"	15,0	103	59	62
20	3/4"	20,0	103	63	70
25	1"	25,0	127	71	81
32	1 1/4"	32,0	127	76	96
40	1 1/2"	38,0	153	89	113
50	2"	50,8	193	98	126
65	2 1/2"	65,0	193	111	169
80	3"	80,0	279	124	191
100	4"	100,0	335	169	217

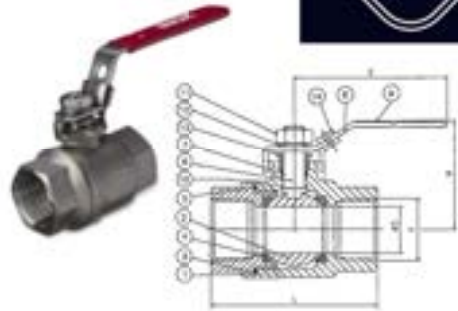

Nr. Dalys Medžiaga

Nr.	Dalys	Medžiaga
1	Korpusas	CFBM
2	Butulis	CFBM
3	Įdėklas	CFBM
4	Atrama	PTFE + GF
5	Korpuso tarpinė	PTFE
6	Šešias	AISI 316
7	Šešio tarpinė	PTFE
8	Rankena	AISI 304
9	Rankenos danga	Plastikas
10	Poveržlė	PTFE
11	Rankenos veržlė	AISI 304
12	Rankenos poveržlė	AISI 304
13	Veržlė	AISI 304
14	Užraktas	AISI 304

Modelis: Lengvas

Busgeriau nr. 7019L

DN	F	D	E	H	L
8	1/4"	11,6	95	51	49
10	3/8"	12,7	95	51	49
15	1/2"	15,0	95	49	57
20	3/4"	20,0	108	55	65
25	1"	25,0	108	58	77
32	1 1/4"	32,0	130	71	90
40	1 1/2"	38,0	130	76	98
50	2"	50,0	150	84	121
65	2 1/2"	65,0	200	125	145
80	3"	80,0	200	136	166
100	4"	100,0	270	165	198

Slėgio/temperatūros lentelė

Bar/cm²

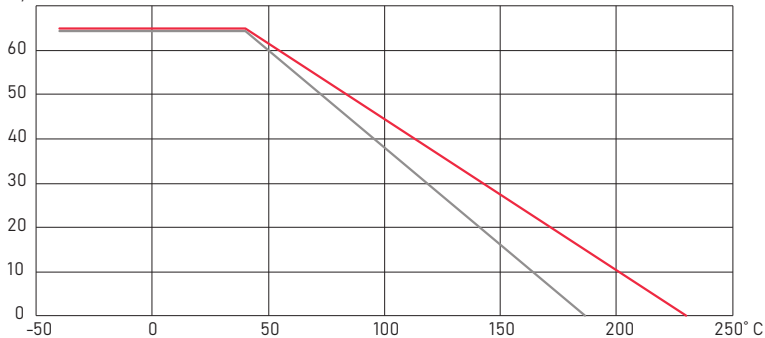

TC 7019

visi dydžiai

7019L

visi dydžiai

Visi išmatavimai sandėliuojami

pardavimai@busgeriau.lt +37066276762

06 Rutulinės sklendės



3-dalių, DN 8-100

Sklytė: pilna Tarpinė: PTFE + GF

Slėgis: Maks. 65 bar



DN	D mm	E mm	H mm	L mm	Srieginiai	Virinami
					Busgeriau nr. 7021	Busgeriau nr. 7022
8	11,0	102	54	65	1/4"	13,7
10	12,5	102	54	65	3/8"	17,2
15	15,0	102	55	71	1/2"	21,3
20	20,0	126	65	85	3/4"	26,7
25	25,4	126	71	95	1"	33,4
32	32,0	150	89	112	1 1/4"	42,2
40	38,0	150	94	123	1 1/2"	48,3
50	50,8	186	100	141	2"	60,3
65	65,0	272	121	173	2 1/2"	73,0
80	80,0	272	134	192	3"	88,9
100	100,0	335	172	225	4"	114,3

Nr.	Dalys	Medžiaga
1	Korpusas	CF8M
2	Rutulys	CF8M
3	Galai	CF8M
4	Atrama	PTFE+ GF
5	Korpuso tarpinė	PTFE
6	Stiebas	AISI 316
7	Stiebas tarpinė	PTFE
8	Rankena	AISI 316
9	Rankenos danga	Plastikas
10	Poveržlė	PTFE
11	Rankenos veržlė	AISI 304
12	Rankenos poveržlė	AISI 304
13	Veržlė	AISI 304
14	Užraktas	AISI 304
15	Varžtas	AISI 304
16	veržlė	AISI 304
17	Poveržlė	AISI 304

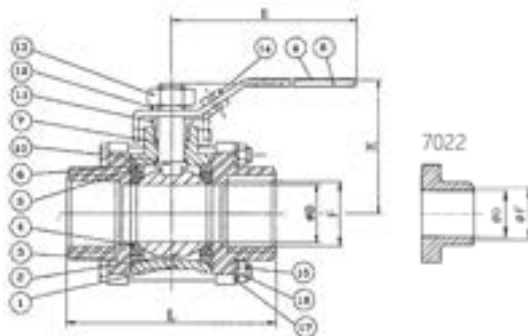

Slėgio/temperatūros lentelė

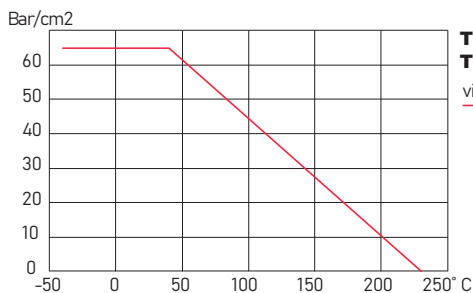

TC 7021
TC 7022
visi dydžiai

Visi išmatavimai sandėliuojami

07 Strypai

07 Strypai

Strypų specifikacijos



Apdirbimas: Tekintas
Išmatavimai: 15-1000 mm
Tolerancijos: EN 10060, ISO h ir k ir spec. tolerancijos

Apdirbimas: Šaltai temptas
Išmatavimai: 3-80 mm
Tolerancijos: EN 10278 h9 ir h10

Apdirbimas: Tekintas ir poliruotas
Išmatavimai: 15-380 mm
Tolerancijos: EN 10278 h9 ir h10 ir spec. tolerancijos

Apdirbimas: Šiluotas
Išmatavimai: 3-155 mm
Tolerancijos: EN 10278 h6, 7, 8 ir 9 ir spec. tolerancijos



Apdirbimas: Šaltai temptas
Išmatavimai: 4-80 mm
Tolerancijos: EN 10278 h11

Apdirbimas: Karštai valcuotas ir ęsdintas
Išmatavimai: 8-250 mm
Tolerancijos: EN 10059



Apdirbimas: Šaltai temptas
Išmatavimai: 4-70 mm
Tolerancijos: EN 10278 h11



Vieša / Ritės: Išmatavimai 5,5-27 mm
Šaltai tempta vieša: Išmatavimai 0,2-16 mm

Šaltai valcuoti



Karštai valcuoti



armatūriniai strypai: Išmatavimai 6-40 mm
"Riljuoti"



Srieginiai strypai: M6-M24

07 Juostos

Tiekimo programa juostoms



Karštai valcuoti Apdirbimas:
Tolerancijos:

Ėsdinti
EN 10058

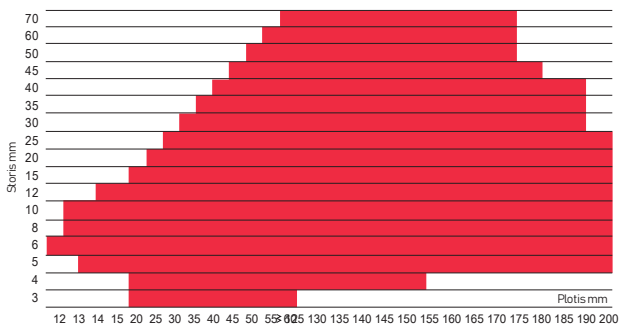

Šaltai valcuoti Tolerancijos:

EN 10278 h11

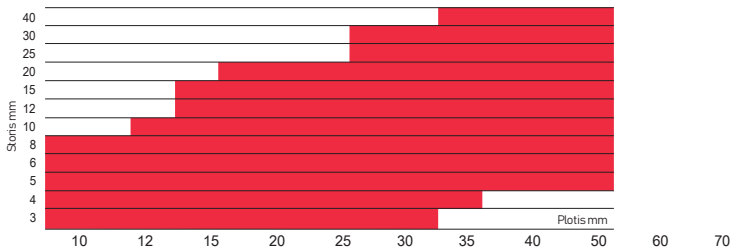

Pjauti iš lakšto Apdirbimas:
Tolerancijos:

Ėsdinti
EN 10058

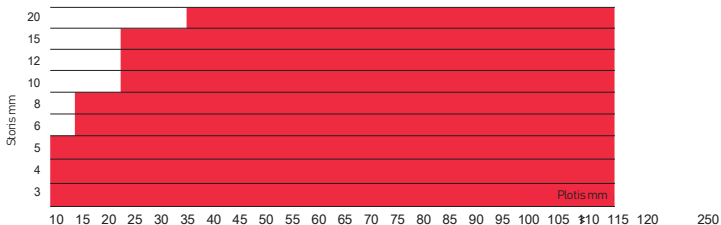

Apdirbimas:
Tolerancijos:

Ėsdinti
EN 10056

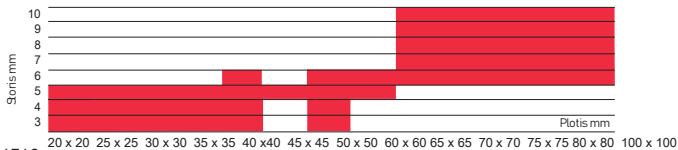

pardavimai@busgeriau.lt +37066276762

07 Strypai

Tolerancijų lentelės



● EN 10060

Diametras mm	Tolerancija mm
10,0 - 15,9	+/- 0,40
16,0 - 25,9	+/- 0,50
26,0 - 35,9	+/- 0,60
36,0 - 50,9	+/- 0,80
51,0 - 80,9	+/- 1,00
81,0 - 100,9	+/- 1,30
101,0 - 124,9	+/- 1,50
125,0 - 160,9	+/- 2,00
161,0 - 200,0	+/- 2,50

● ISO 286-2 - tol. k12/k13

Diametras mm	Tolerancija mm
18,1 - 30,0	-0/+ 0,21
30,1 - 50,0	-0/+ 0,25
50,1 - 80,0	-0/+ 0,30
80,1 - 120,0	-0/+ 0,35
120,1 - 180,0	-0/+ 0,40
185,0 - 250,0	-0/+ 0,72
260,0 - 300,0	-0/+ 0,81
320,0 - 400,0	-0/+ 0,89

● ■ ● EN10278 / ISO 286-2 Tolerancijos

Diametras mm	h6	h7	h8	h9	h10	h11	h12
≤ 3,00	0,006	0,010	0,014	0,025	0,040	0,060	0,100
3,01 - 6,00	0,008	0,012	0,018	0,030	0,048	0,075	0,120
6,01 - 10,00	0,009	0,015	0,022	0,036	0,058	0,090	0,150
10,01 - 18,00	0,011	0,018	0,027	0,043	0,070	0,110	0,180
18,01 - 30,00	0,013	0,021	0,033	0,052	0,084	0,130	0,210
30,01 - 50,00	0,016	0,025	0,039	0,062	0,100	0,160	0,250
50,01 - 80,00	0,019	0,030	0,046	0,074	0,120	0,190	0,300
80,01 - 120,00	0,022	0,035	0,054	0,087	0,140	0,220	0,350
120,01 - 180,00	0,025	0,040	0,063	0,100	0,160	0,250	0,400
180,01 - 200,00	0,029	0,046	0,072	0,115	0,185	0,290	0,460

■ EN 10058

Plotis mm	Tolerancija mm	Storis mm	Tolerancija mm
10 - 40	+/-0,75	5-20	+/-0,50
41 - 80	+/-1,00	21-40	+/-1,00
81 - 100	+/-1,50	41-80	+/-1,50
101 - 120	+/-2,0		
121 - 150	+/-2,5		

■ EN 10059

Išmatavimai mm	Tolerancija mm
8-0 - 14,9	+/-0,40
15,0 - 25,9	+/-0,50
26,0 - 35,9	+/-0,60
36,0 - 50,9	+/-0,80
51,0 - 99,9	+/-1,00
100,0 - 109,9	+/-1,30
110,0 - 129,9	+/-1,50
130,0 - 150,0	+/-1,80

L EN 10056

Plotis mm	Tolerancija mm	Storis mm	Tolerancija mm
20 - 50	+/-1,0	3 - 5	+/-0,50
60 - 100	+/-2,0	6 - 10	+/-0,75

pardavimai@busgeriau.lt +37066276762

07 Strypai



Austenitinis & Martenitinis

Sandėliuojamas Ilgis: 5-6 m. EN 1.4305 3 m.

D mm	Tolerancija mm	kg/m	EN 1.4307	EN 1.4404	EN 1.4305	EN 1.4021	EN 1.4057
16,0	-0/+ 0,18	1,6	○	○	○	◐	◐
20,0	-0/+ 0,21	2,5	○	●	○	○	○
22,0	-0/+ 0,21	3,0	●	●	○	◐	◐
25,0	-0/+ 0,21	3,9	●+3m	●+3m	●	◐	●
26,0	-0/+ 0,21	4,2	○	●	○	○	○
28,0	-0/+ 0,21	4,8	●+3m	●	●	◐	◐
30,0	-0/+ 0,21	5,5	●+3m	●+3m	●	◐	●
32,0	-0/+ 0,25	6,3	●+3m	●	●	◐	●
35,0	-0/+ 0,25	7,6	●+3m	●+3m	●	◐	●
36,0	-0/+ 0,25	8,0	●+3m	●+3m	●	○	○
38,0	-0/+ 0,25	8,9	●+3m	●+3m	●	○	◐
40,0	-0/+ 0,25	9,9	●+3m	●+3m	●	◐	●
42,0	-0/+ 0,25	10,9	●+3m	●+3m	●	○	○
45,0	-0/+ 0,25	12,5	●+3m	●+3m	●	◐	●
50,0	-0/+ 0,25	15,4	●+3m	●+3m	●	◐	●
51,0	-0/+ 0,30	16,0	○	●+3m	○	○	○
55,0	-0/+ 0,30	18,7	●+3m	●+3m	●	◐	●
60,0	-0/+ 0,30	22,2	●+3m	●+3m	●	◐	●
65,0	-0/+ 0,30	26,1	●+3m	●+3m	●	◐	●
70,0	-0/+ 0,30	30,2	●+3m	●+3m	●	◐	●
75,0	-0/+ 0,30	34,7	●+3m	●+3m	●	◐	●
80,0	-0/+ 0,30	39,5	●+3m	●	●	◐	●
85,0	-0/+ 0,35	44,6	●	●	●	◐	●
90,0	-0/+ 0,35	49,9	●+3m	●	●	◐	●
95,0	-0/+ 0,35	55,6	●	●+3m	●	○	●
100,0	-0/+ 0,35	61,7	●	●	●	◐	●
105,0	-0/+ 1,00	68,0	●	●	●	○	◐
110,0	-0/+ 1,00	74,6	●	●	●	◐	●
115,0	-0/+ 1,00	81,5	●	●	●	○	●
120,0	-0/+ 1,00	88,8	●	●	●	◐	●
125,0	-0/+ 1,00	96,3	●	●	●	○	●
130,0	-0/+ 1,00	104,2	●	●	●	○	●
135,0	-0/+ 1,00	112,4	●	●	●	○	○
140,0	-0/+ 1,00	120,8	●	●	●	◐	●
145,0	-0/+ 1,00	129,6	●	●	●	○	○
150,0	-0/+ 1,00	138,7	●	●	●	○	●
155,0	-0/+ 1,00	148,1	●	●	○	○	○
160,0	-0/+ 1,00	157,8	●	●	●	◐	◐
165,0	-0/+ 1,00	167,9	●	●	○	○	○
170,0	-0/+ 1,0	178,2	●	●	●	○	○
175,0	-0/+ 1,0	188,8	●	●	○	○	○
180,0	-0/+ 1,0	200,0	●	●	●	○	○
185,0	-0/+ 1,0	211,0	○	●	○	○	○
190,0	-0/+ 1,0	223,0	●	●	●	○	○
200,0	-0/+ 1,0	247,0	●	●	●	○	○
205,0	-0/+ 1,0	259,1	○	●	○	○	○

pardavimai@busgeriau.lt +37066276762

