

THINK and **LOOK** ahead

Glory on the mountain

MATTHEW 17:1-9

Jesus took Peter, James, and John to see something amazing at the top of a mountain

Help them to find the way to Mount Tabor

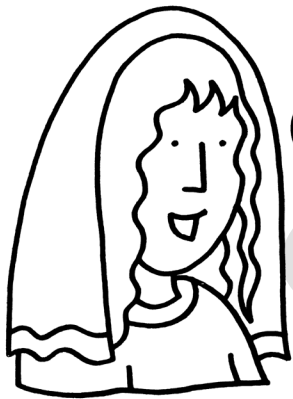

I am a woman Jesus meets next week.
What does he ask for?



Circle the answer!



1. ICE LOLLY



2. SWEETS



3. FOOD



4. WATER

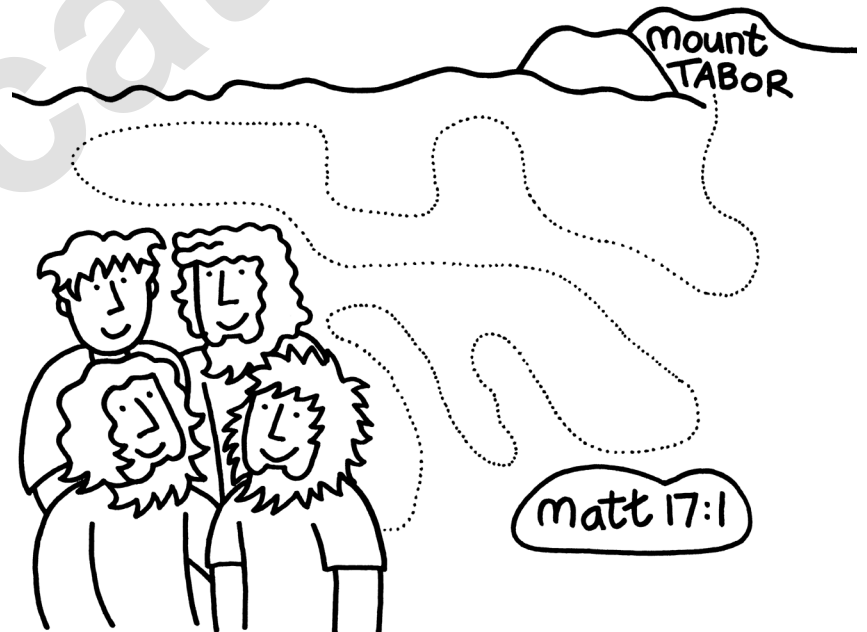

Jesus shone like
the sun! His clothes were
brilliant white!

What had the
three disciples glimpsed on the
mountain that day?

Write the first letter of each picture to find out what happened

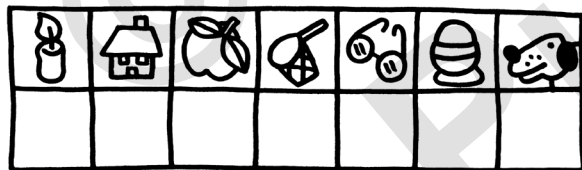
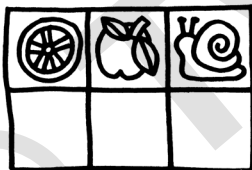

Copy the letters on the lines

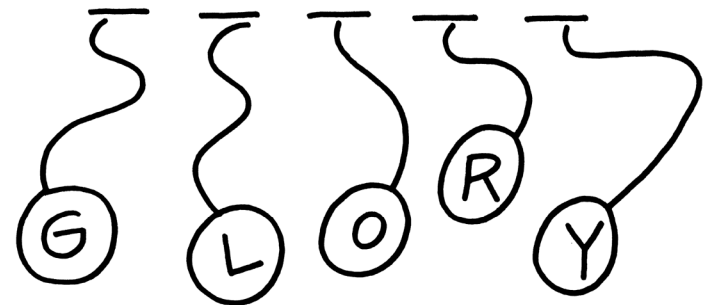

THINK and **LOOK** ahead

The Water of Life

JOHN 4:5-42

Who does Jesus stop to help next week?

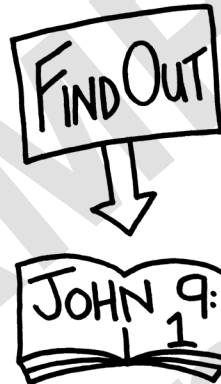

A
B _ _ _ _
M A N

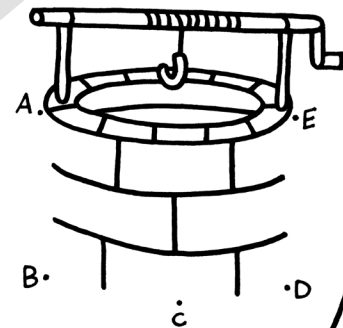
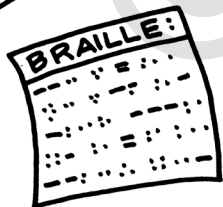
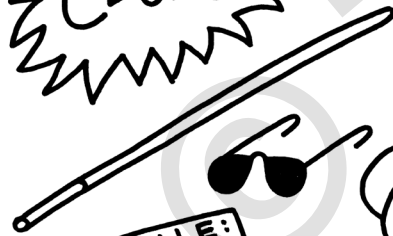

Trace the letters!



Water is a symbol of life—
without it, everything would die!

Which of these objects can be used to water something?
Circle your answers!



These pictures have been muddled up.
Can you arrange them in order to tell today's gospel story?
Write the letters below

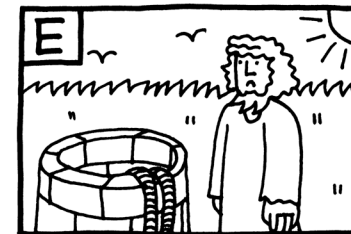

1. ____ 2. ____ 3. ____ 4. ____ 5. ____

THINK and **LOOK** ahead

Help us to see!

JOHN 9:1-41

These two sisters are very worried.

Can you find out why?



Their brother is

Jesus met a blind man and stopped to help him.

What did Jesus do?

Put a check mark by the right answer!



Jesus told him to wash his eyes, and when he did, what was he amazed to find?

Jesus made the man see that he was the Son of God!

Copy the letters on to the lines

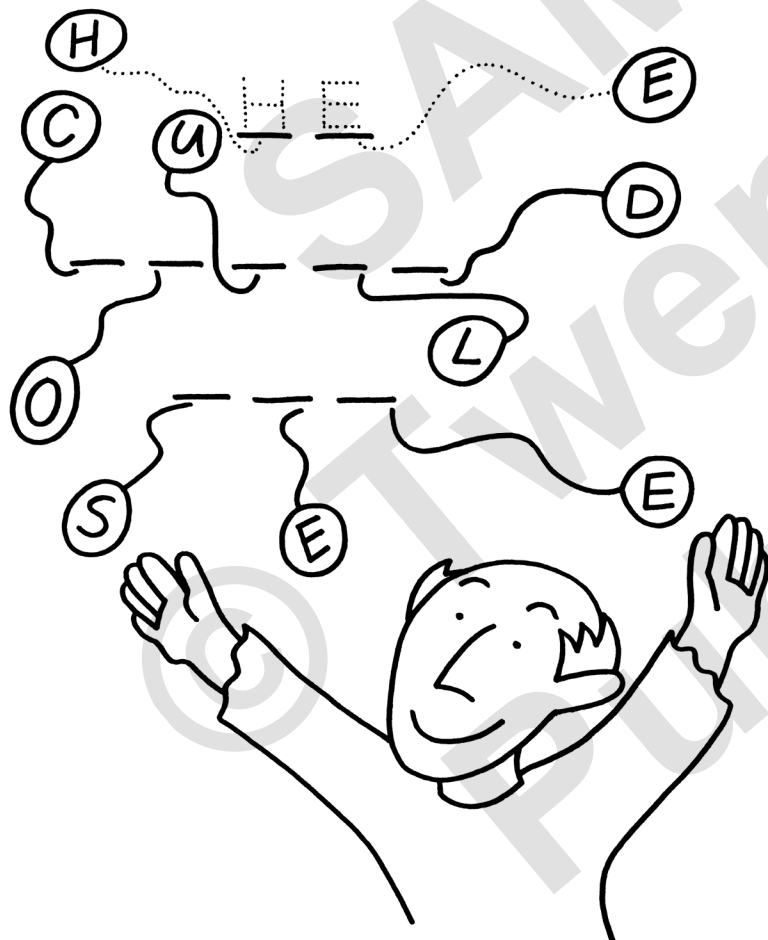

Draw pictures of some of the things you can see at this moment!

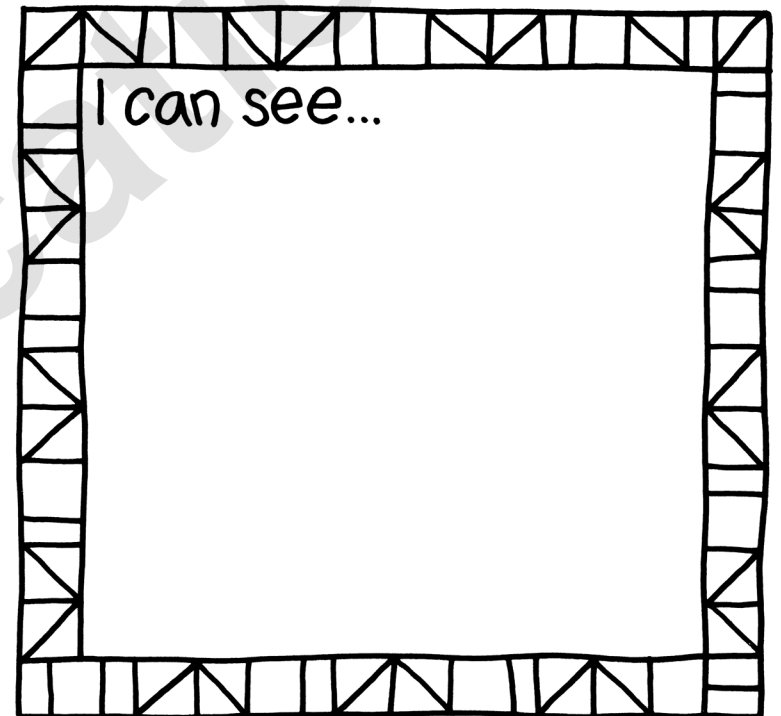

THINK and **LOOK** ahead

Lazarus is alive!

JOHN 11:1-45

Next week Jesus goes to Jerusalem.

What would he use to get there?

Martha and Mary sent a message to Jesus because Lazarus was very sick.

Mark your answer with an X

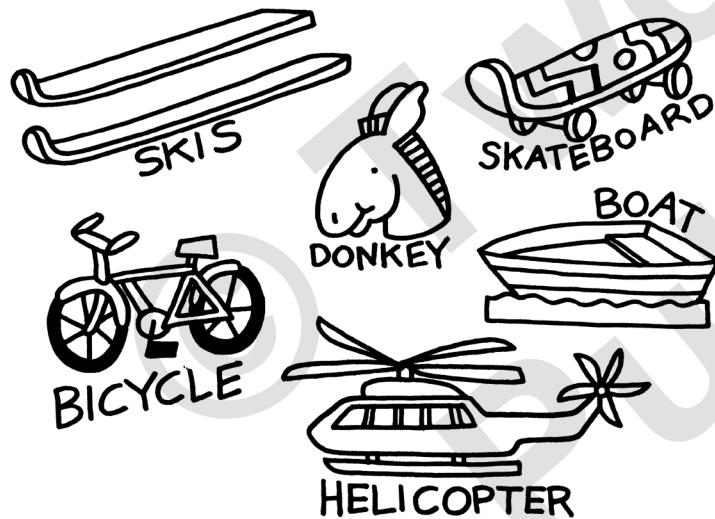

Trace the letters to read what the message says

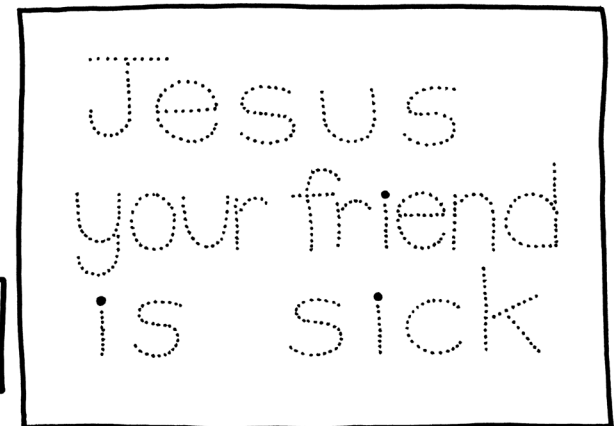

When Jesus arrived he found that Lazarus had died.

Martha and Mary knew that Jesus was God's Son, and that nothing was impossible for him (John 11:22).

Connect the dots to see where they had put Lazarus

Color the spaces with a * to see why the people are so amazed!

