

1200x800x2000mm

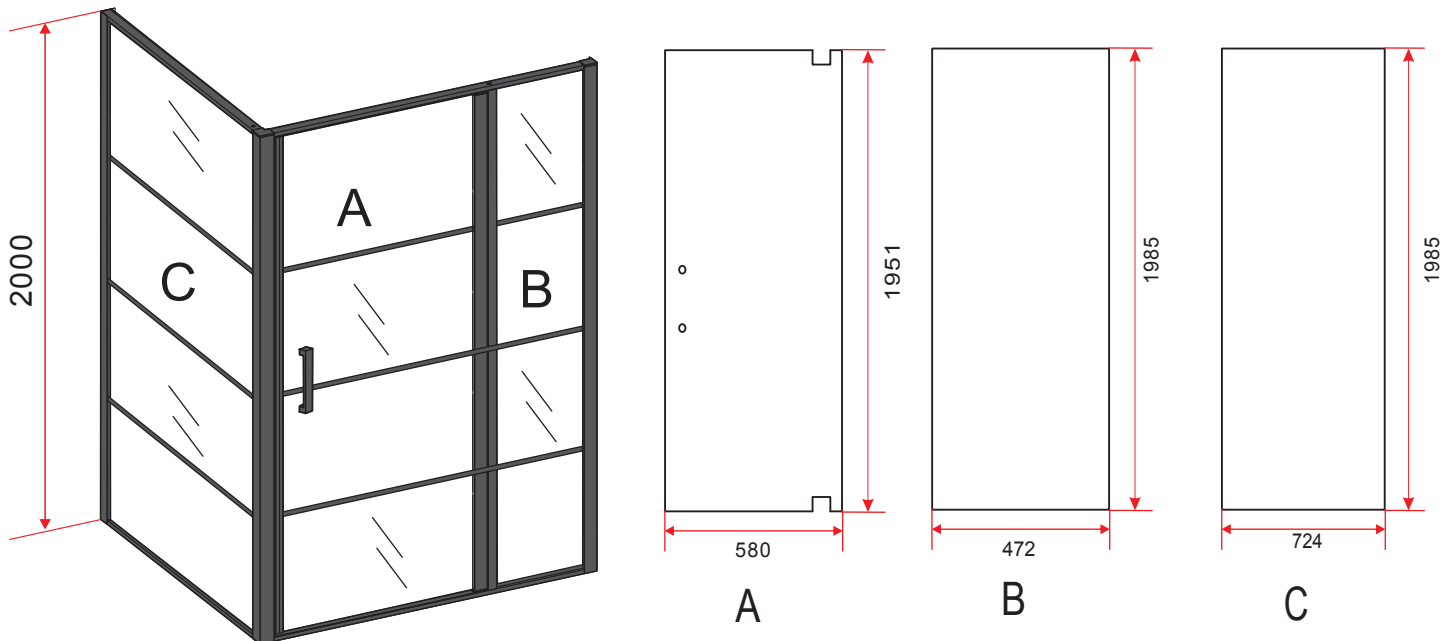

TECHNICAL DRAWING



INSTALLATION MANUAL



CR045-80120

CR045-90120

CR045-90140

CR045-90160

RoHS  ISO9001:2008

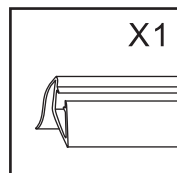
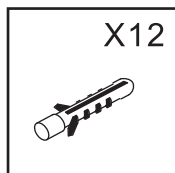
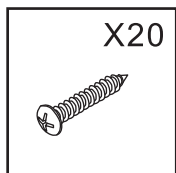
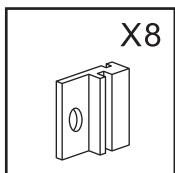
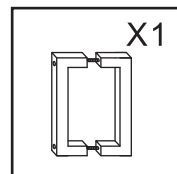
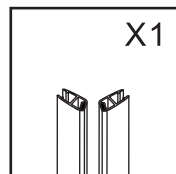
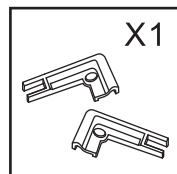
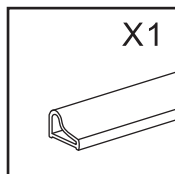
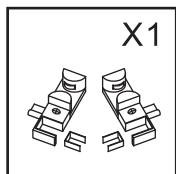
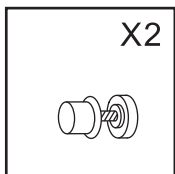
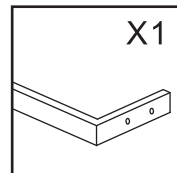
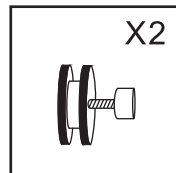
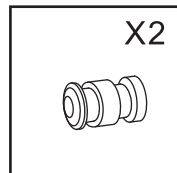
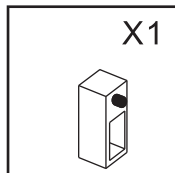
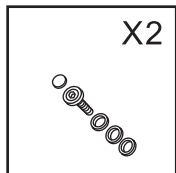
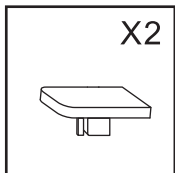
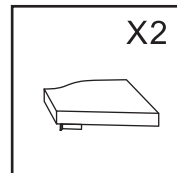
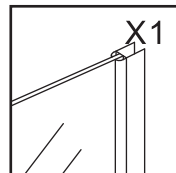
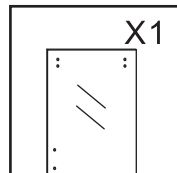
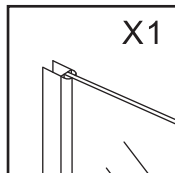
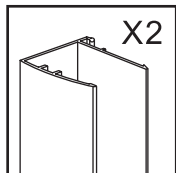
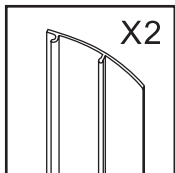
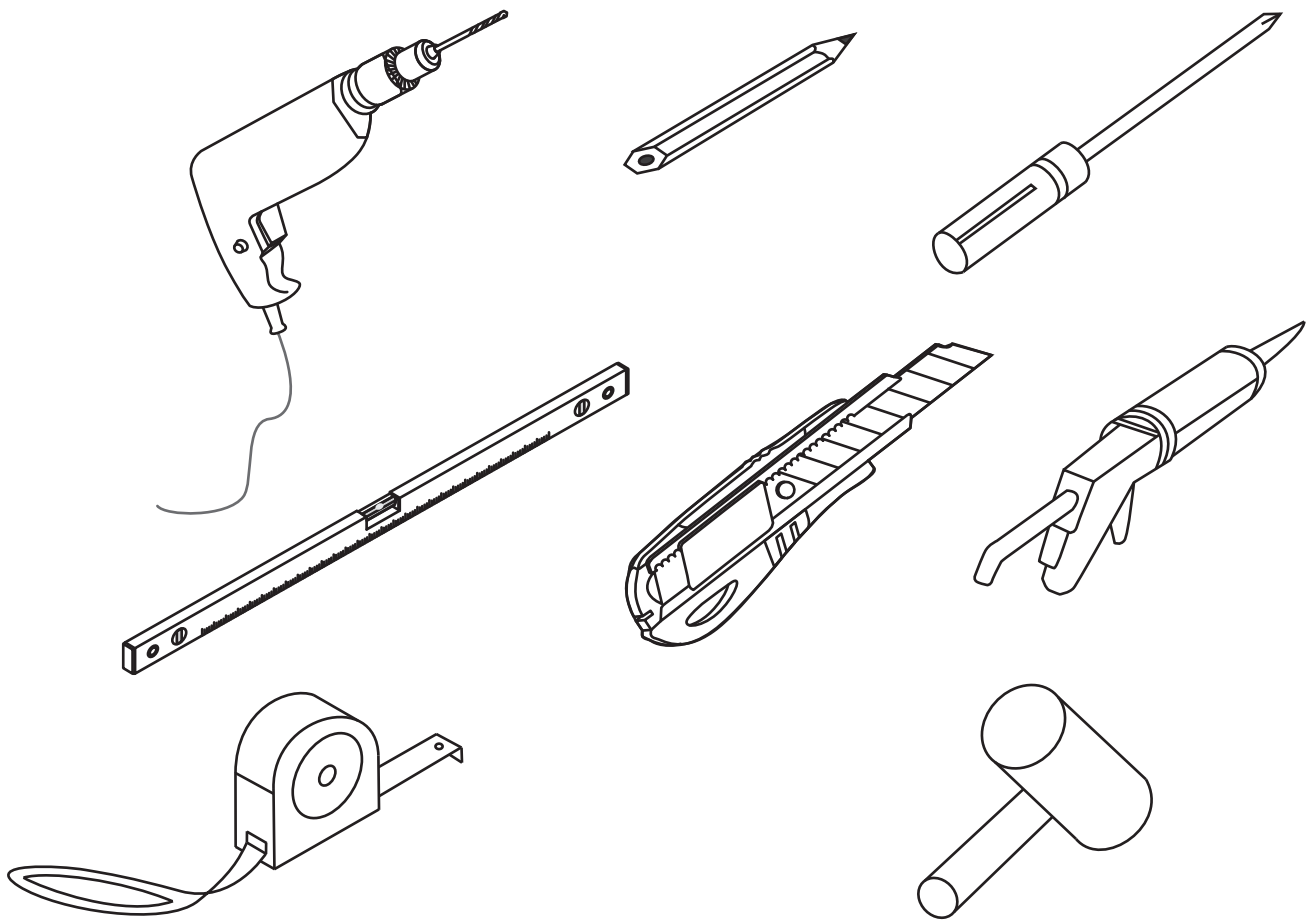

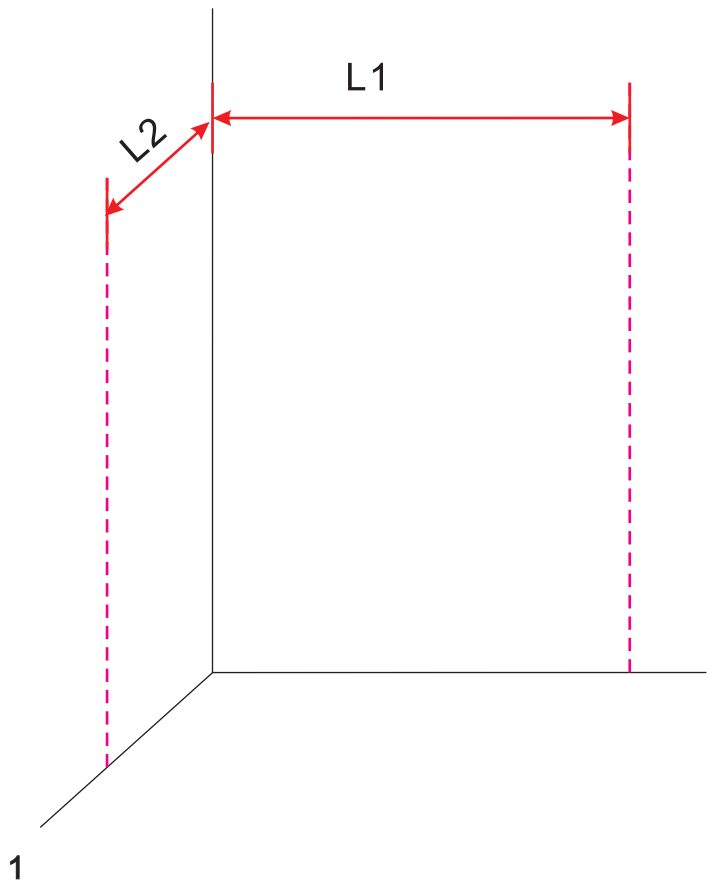

SIZE	L1	L2
1180-1200x780-800x1950	1175	775
1180-1200x880-900x1950	1175	875
1380-1400x880-900x1950	1375	875
1580-1600x880-900x1950	1575	875

1

Install the wall profile: according the line to install the profile notice: put the profile in middle of line.

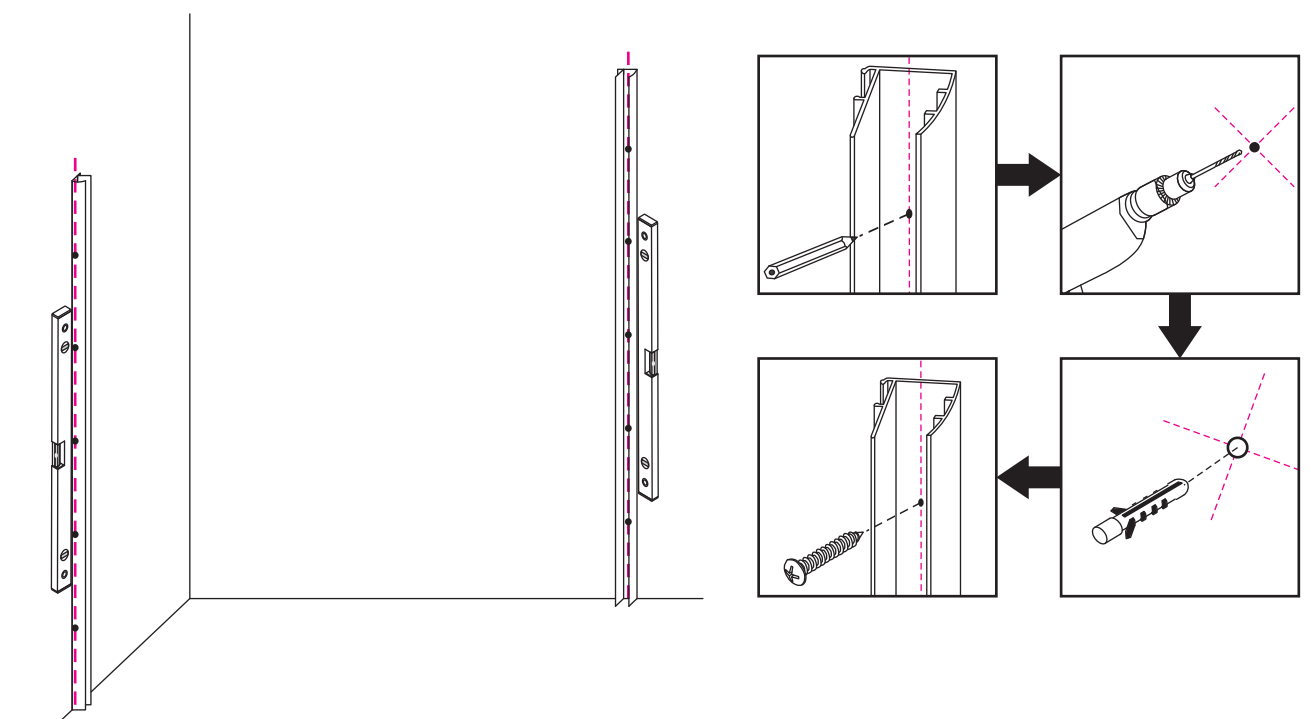

2

Install the fixed glass: insert the fixed glass into wall profile.

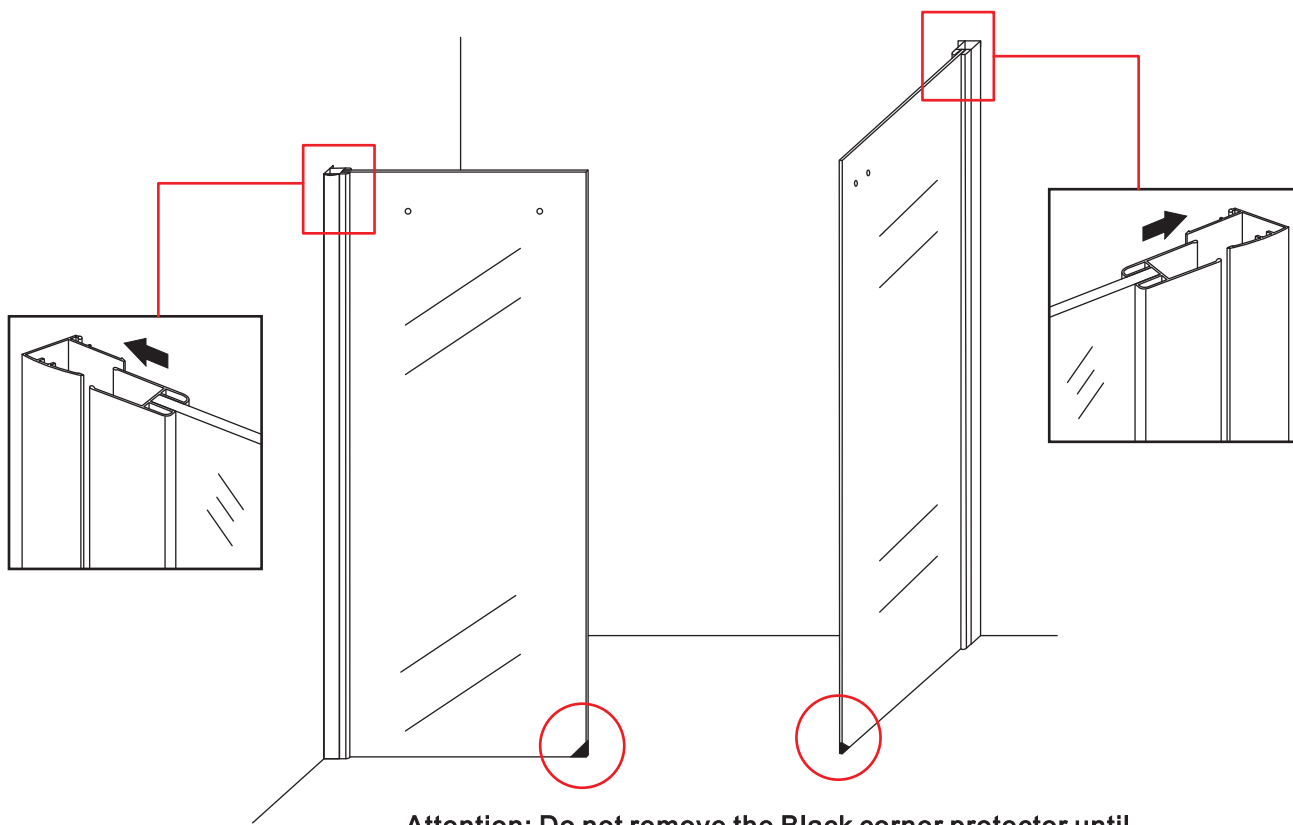

Attention: Do not remove the Black corner protector until insert well the glass into the wall profiles and fit well to prevent glass broken and splitted.



3

Install the "L" guide rail .

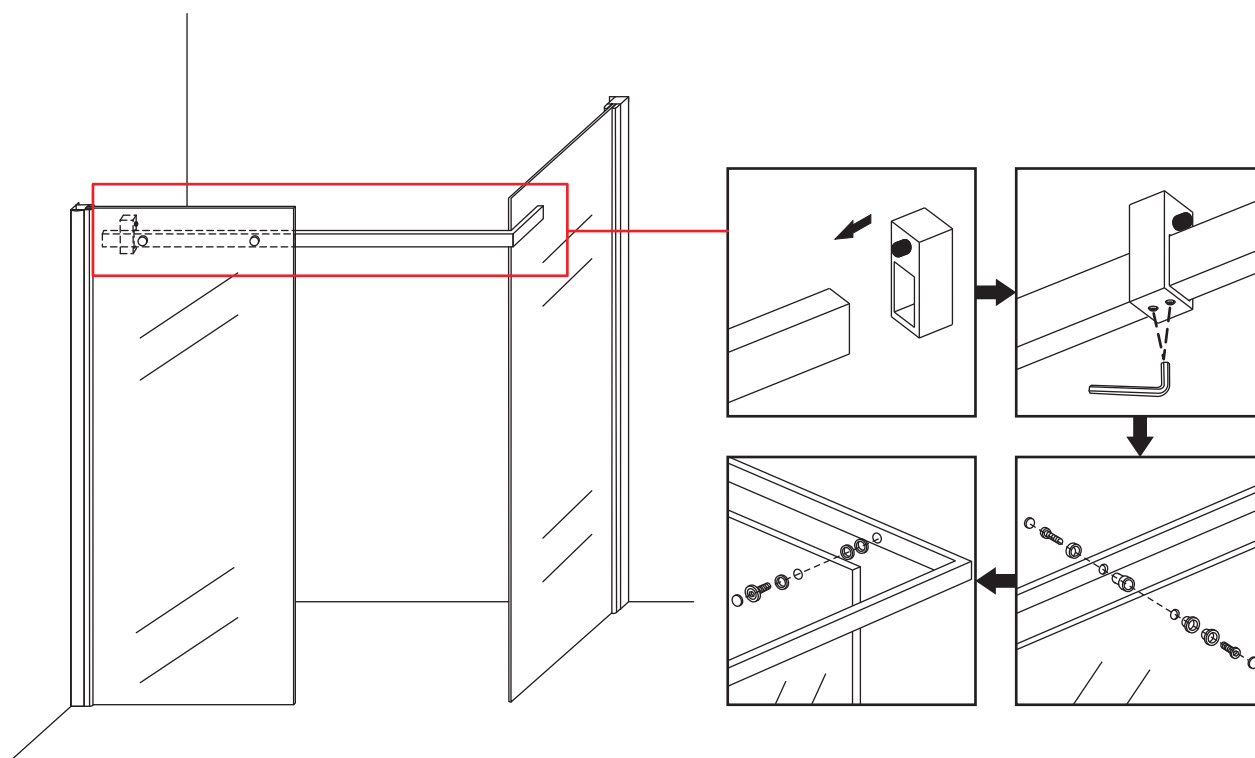

4

install the decorate part and Aluminum water-proof gasket.

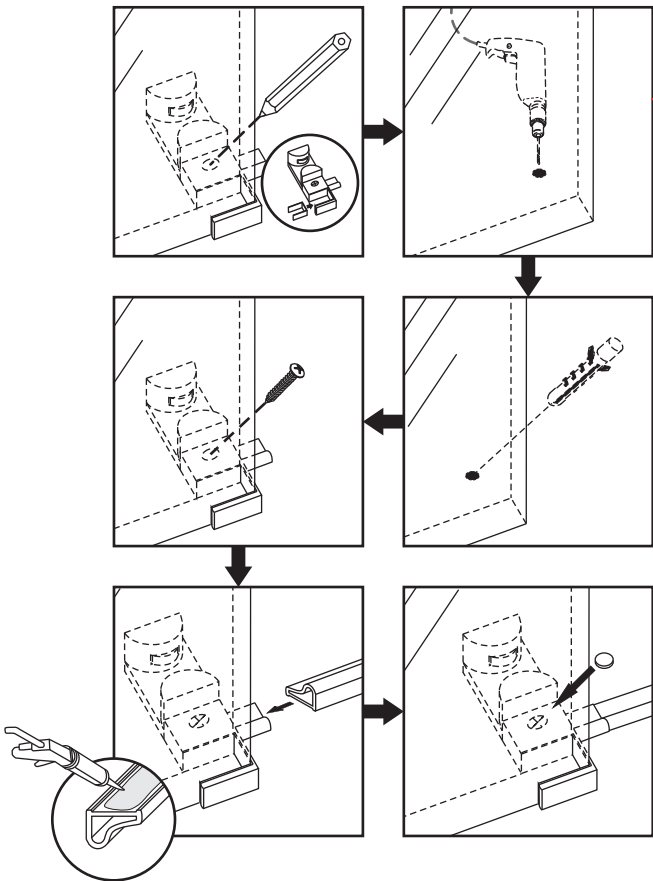

5

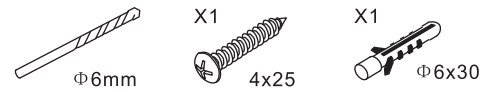
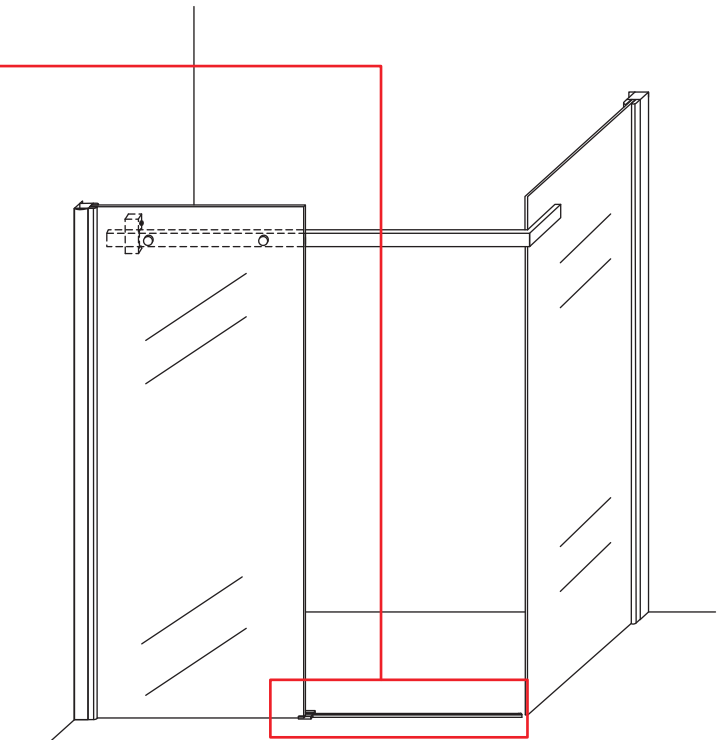

Install the aluminum corner decorate part.

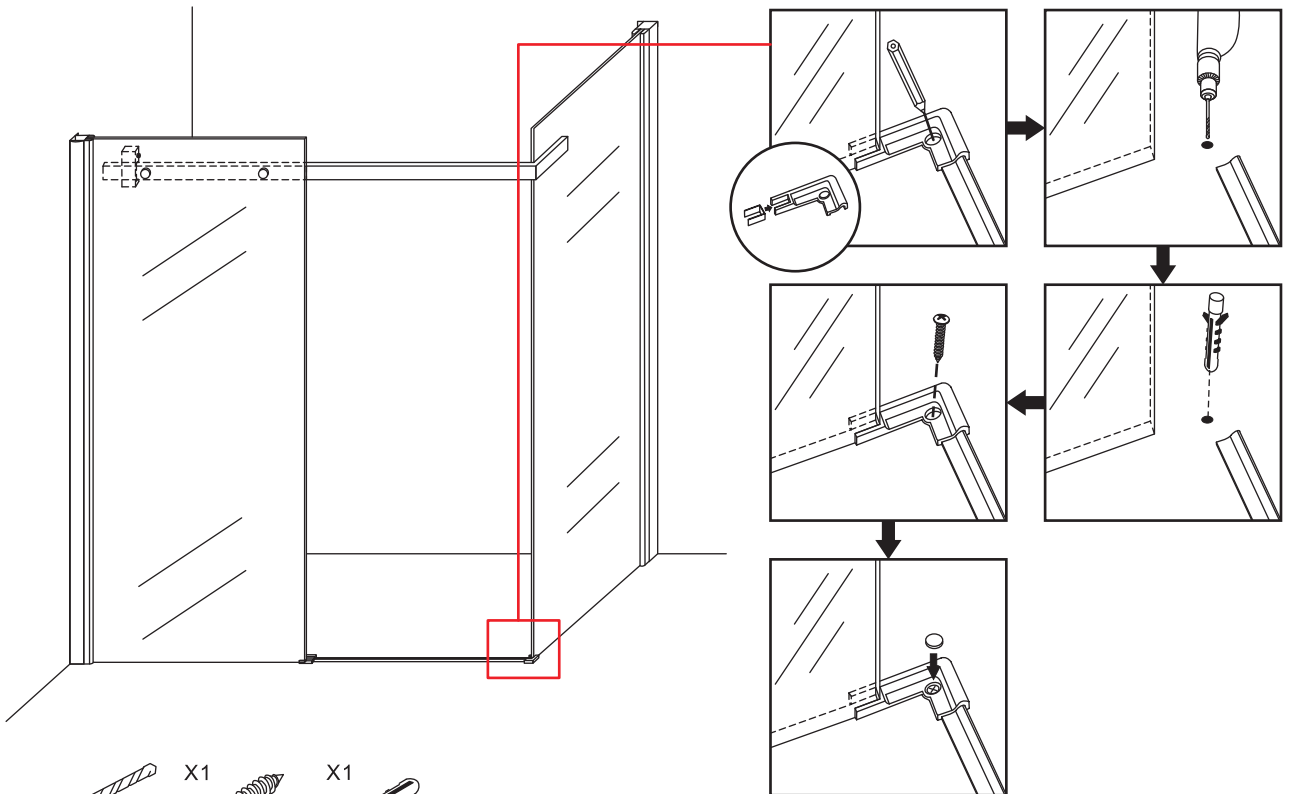

6

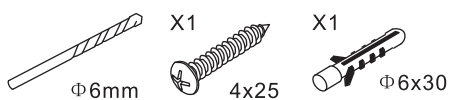

Install the door glass.

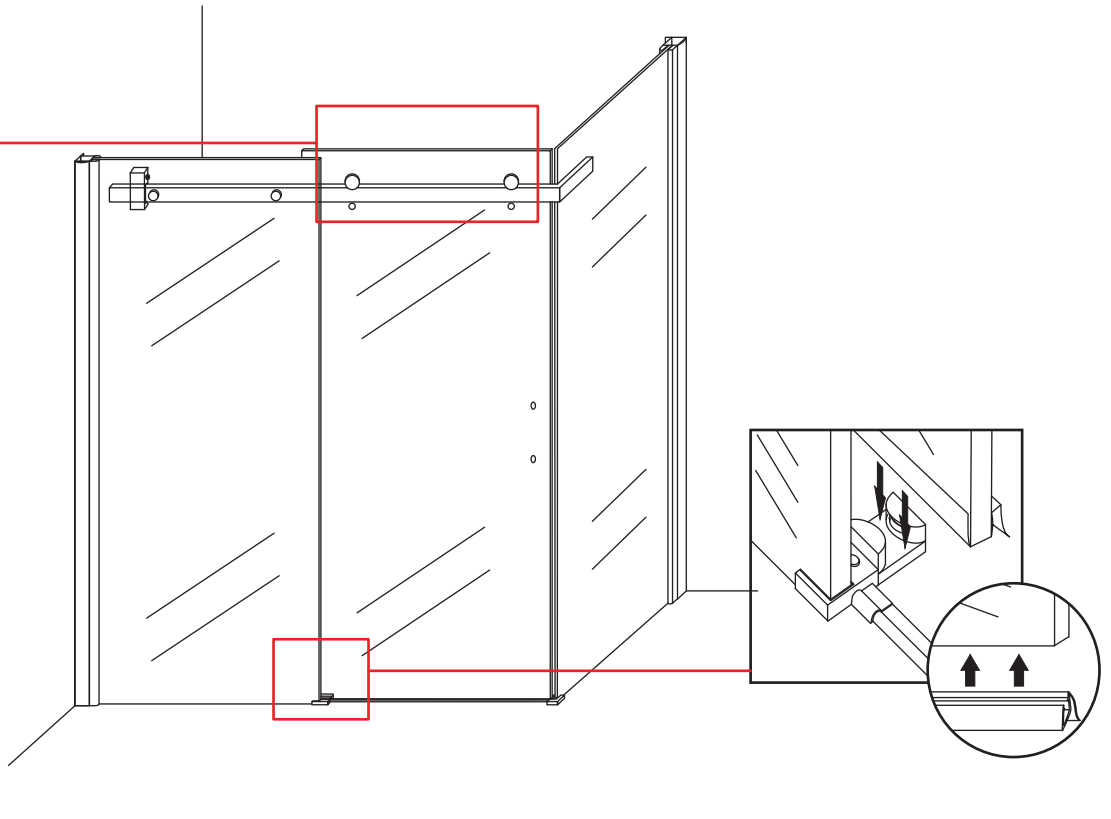
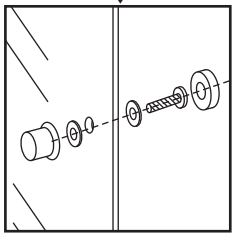
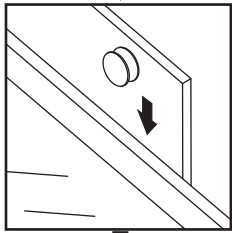
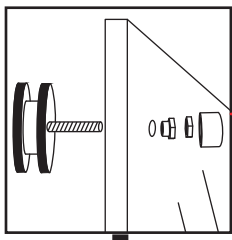

7

1. Install the water-proof gasket.
2. Install the magnetic stripe.
3. Install the handle.

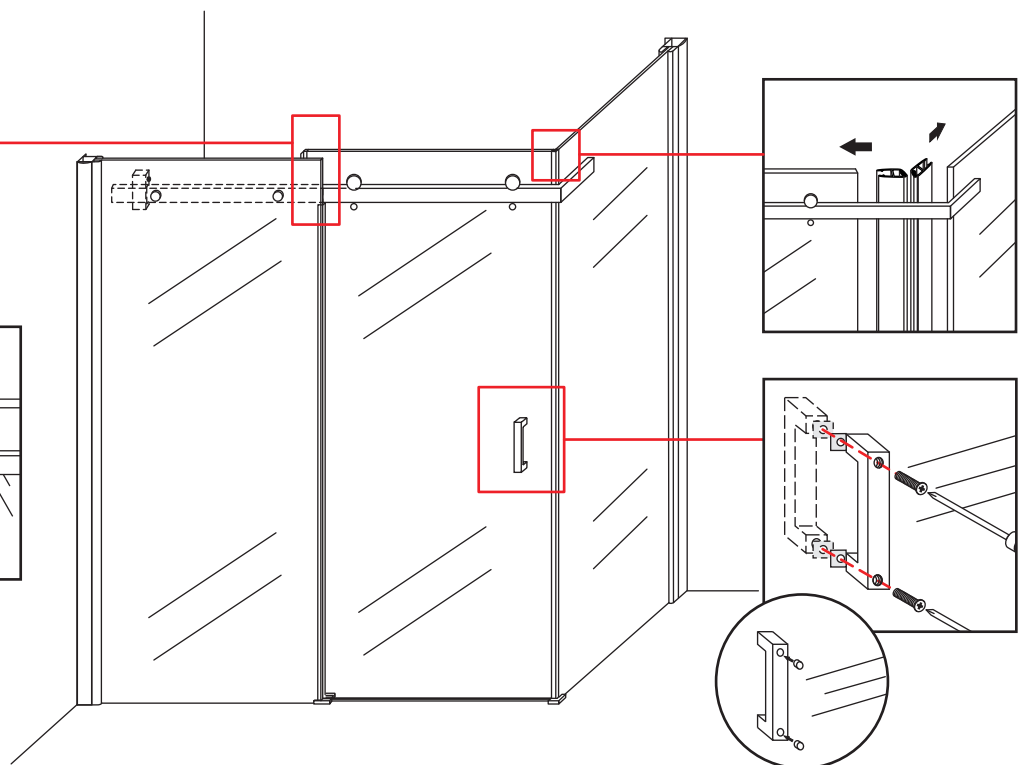
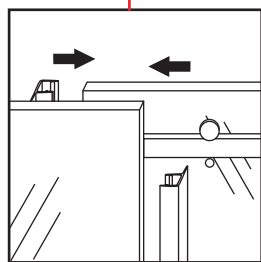

8

Install the decorate profile:install the connect buckle,insert the decorate profile into buckle as picture shows, then install the top decorate cap.

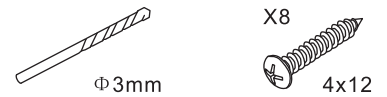
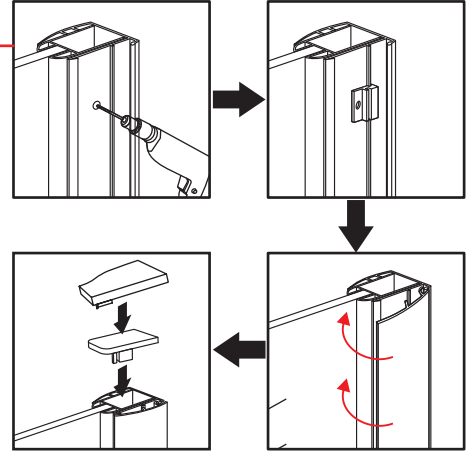
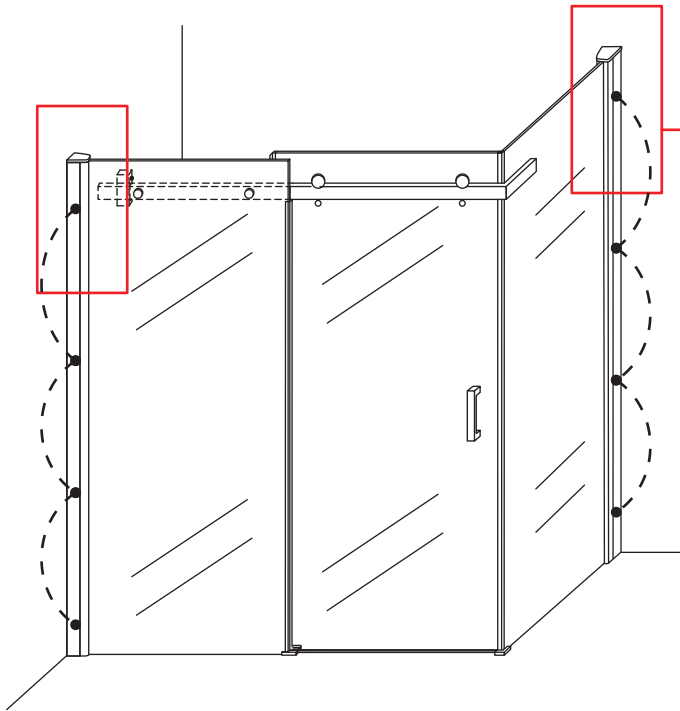

9

Take glue:please keep dry until 24 hour.

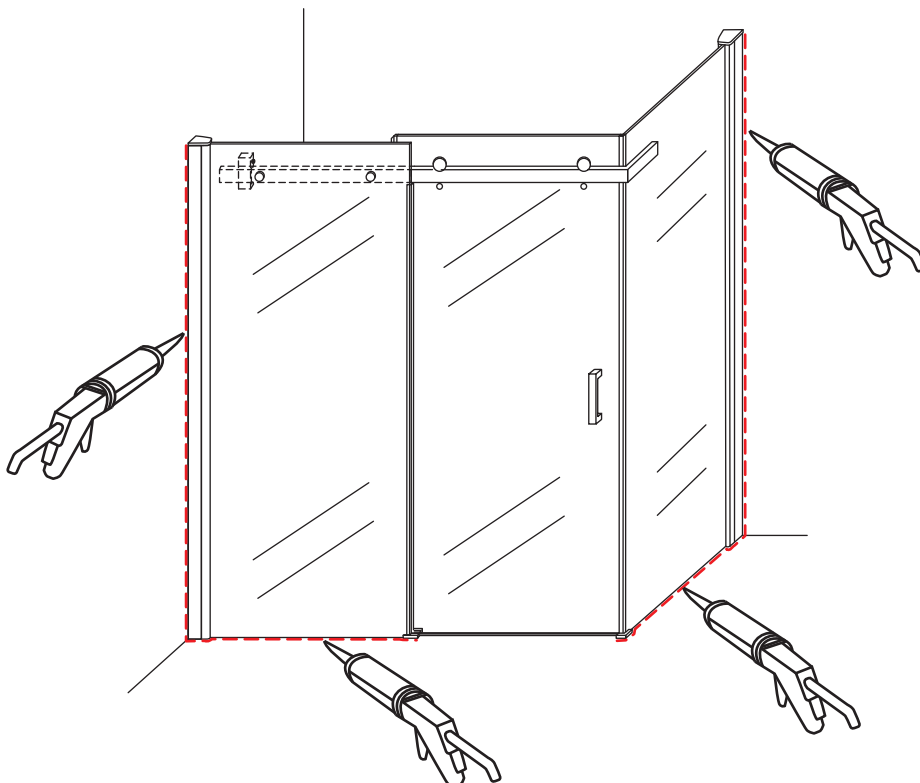

10