

MARK 2 SERIES

Mark 2/Mark 2 Plus/Mark 2 PE

User Manual

V1.22

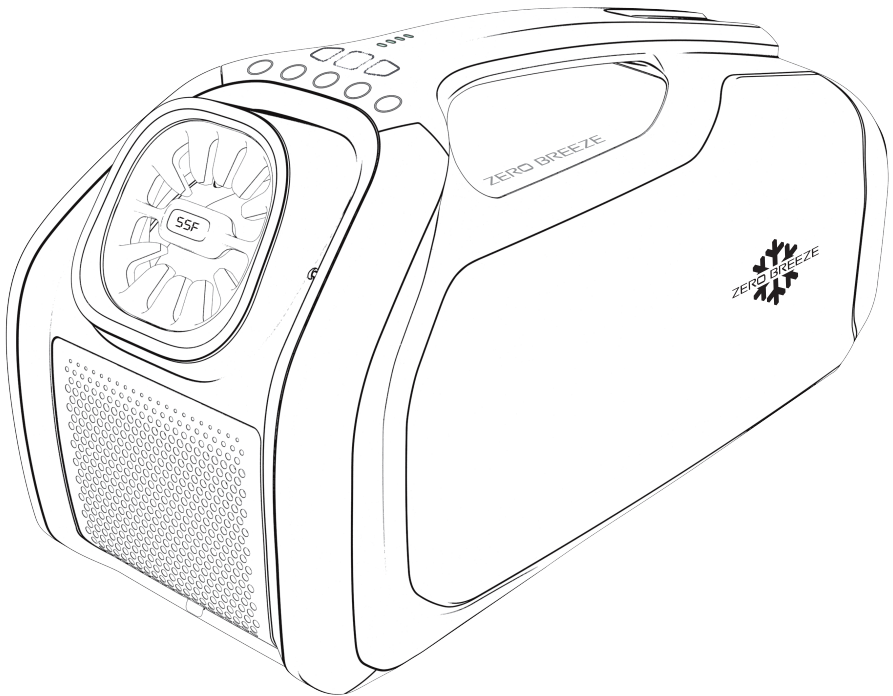

CONTENTS

SAFETY PRECAUTIONS	01
MARK 2 FEATURES	03
CONTROL PANEL&REMOTE CONTROL	04
HOW TO USE YOUR MARK 2	06
USE ENVIRONMENT	11
PLACEMENT TIPS	12
WINDOW ACCESSORY INSTALLATION	13
COLD AIR EXTENSION PIPE INSTALLATION	14
AIR FILTER CLEANING TIPS	15
MALFUNCTION DIAGNOSIS	16
SPECIFICATION	19
WHAT'S IN THE BOX	20

SAFETY PRECAUTIONS

Read This Manual

Inside you'll find many helpful tips on how to use and maintain your air conditioner properly. Just a little preventive care on your part can save you a great deal of time and money as well as extend the life of your air conditioner. You'll find many answers to common problems in the troubleshooting page you should be able to fix most of them quickly before calling service. These instructions may not cover every possible condition of use, so common sense and attention to safety is required when installing, operating and maintaining this product.



- **Contact the authorized service technician for repair or maintenance of this unit.**
- **The air conditioner is not intended for use by young children or anyone unable to operate it independently.**
- **When using this unit in the presence of children they should always be supervised.**
- **If the power cord needs to be replaced, please contact our consumer service to find an authorized technician.**
- **Electrical installation must be performed in accordance to national regulation standards by qualified personnel only.**

CAUTION: This symbol indicates the possibility of injury or damage to property

This appliance is not intended for use by persons (including children) with reduced physical, sensory or mental capabilities, unless they have been given supervision or instruction concerning use of the appliance by a person responsible for their safety.

- If the power cord is damaged, it must be replaced by the manufacturer, its service agent or similarly qualified persons in order to avoid a hazard.
- Prior to cleaning or other maintenance, the appliance must be disconnected from electricity.
- Do not install the appliance in a location that may be exposed to combustible gas. If combustible gas accumulates around the unit, it may cause fire.
- Do not run the power cord under carpeting. Do not cover cord with throw rugs, runners, or similar coverings. Do not route cord under furniture or appliances. Arrange cord away from traffic area and where it will not be tripped over.
- To reduce the risk of fire or electric shock, do not use this air conditioner with any solid-state speed control device.
- The appliance shall be installed in accordance with national wiring regulations.
- Contact the authorized service technician for repair or maintenance of this unit.

- Do not mix old and new batteries.
- Do not mix alkaline, standard (carbon-zinc), or rechargeable (ni-cad, ni-mh, etc.) batteries.

To prevent injury to the user or other people and property damage, the following instructions must be followed.

 WARNING: This symbol indicates the possibility of death or serious injury.

- Installation must be performed according to the installation instructions. Improper installation can cause water leakage, electrical shock, or fire.
- Use only the included accessories and parts, and specified tools for the installation. Using non-standard parts can cause water leakage, electrical shock, fire, and injury or property damage.
- Make sure that the outlet you are using is grounded and has the appropriate voltage. The power cord is equipped with a three-prong grounding plug to protect against shock. Voltage information can be found on the side of the unit, behind the grille.
- Install the unit on a flat, sturdy surface. Failure to do so could result in damage or excessive noise and vibration.
- The unit must be kept free from obstruction to ensure proper functioning and to mitigate safety hazards.
- DO NOT modify the length of the power cord or use an extension cord to power the unit. DO NOT share a single outlet with other electrical appliances. Improper power supply can cause fire or electrical shock.
- DO NOT install your air conditioner in a wet room such as a bathroom or laundry room. Exposure to water can cause electrical components to short circuit.
- DO NOT install the unit in a location that may be exposed to combustible gas, as this could cause fire.
- DO NOT operate a unit that has been dropped or damaged.
- Only use the included accessories and specified parts for installation. Using nonstandard parts can cause water leakage, electrical shock, fire, and injury or property damage.
- DO NOT allow children to play with the air conditioner. Children must always be supervised around the unit.
- If the air conditioner is knocked over during use, turn off the unit and unplug it from the main power supply immediately. Visually inspect the unit to ensure there is no damage. If you suspect the unit has been damaged, contact a technician or customer service for assistance.
- In a thunderstorm, the unit should be turned off to avoid damage to the machine due to lightning

Notes on fluorinated gases

- This air-conditioning unit is a sealed unit containing a fluorinated gas. For information on specific gas types and quantities, see the relevant label on the device. Mark2 does not support users adding refrigerant themselves.
- Maintenance or repair of this equipment must be performed by a certified technician.
- Product recycling must be performed in accordance with local regulations.

Note

- All pictures in this manual are for illustration only. Your air conditioner may be slightly different depending on your model.

MARK 2 FEATURES

The Mark2 is equipped with a new 24V high-performance compressor, and the outlet temperature can be lower than the ambient temperature of 28 °F in 10 minutes. The new dual-hose exhaust system improves space cooling speed by 40% over the first generation. The classic handle design makes it easy to move. Using Mark2's special battery can achieve a maximum continuous working time of about 5 hours.

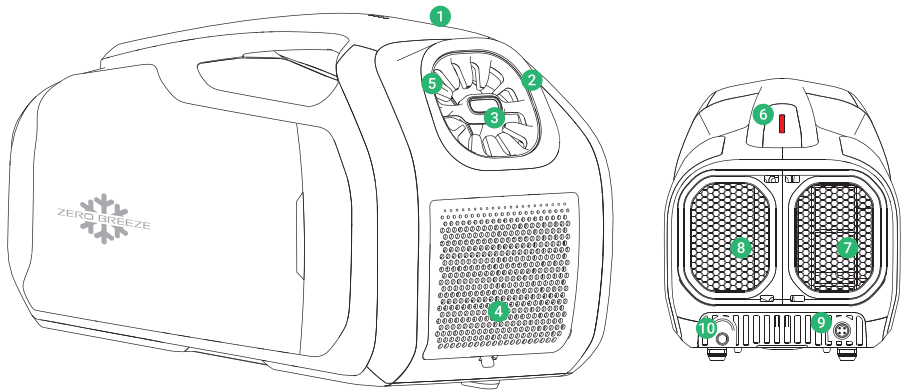

- | | |
|------------------------------------|----------------------|
| 1. Control Panel | 8. Exhaust air inlet |
| 2. Outlet air direction adjustment | 9. Power input |
| 3. Outlet air temperature display | 10. Pipe connector |
| 4. Air filter | |
| 5. LED lights | |
| 6. Status light | |
| 7. Exhaust air outlet | |

Design and Compliance Notes

In order to ensure the optimal performance of our products, the design specifications of the unit and remote control are subject to change without prior notice.

The Energy Rating for this unit is based on the installation of two unextended exhaust ducts.

* The batteries shown in this manual need to be purchased separately, please refer to the zerobreeze.com for more details.

** The cooling speed and maximum working time are measured under the experimental environment and are for reference only.

*** Mark2 already contains a set of intake and exhaust hoses. If you need a longer hose, learn more from zerobreeze.com.

CONTROL PANEL&REMOTE CONTROL

Power Button

•Press once to power on, to turn off press once more.

•After the unit is stopped, the compressor cannot be restarted for one minute. This is to protect the equipment.

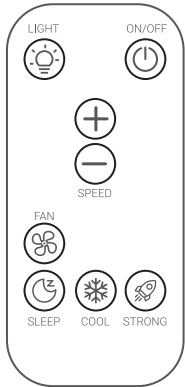

+Button

✱ Increase blowing speed.

*Alternative function
Long press to increase temperature display brightness.



-Button

✱ Decrease blowing speed

*Alternative function
Long press to decrease temperature display brightness.



FAN mode

✱ Press the FAN button, the FAN indicator is on, and the other modes are off.

✱ When the air conditioner enters in FAN mode, the compressor and exhaust fan will be turned off after 5 seconds, and the air conditioner status indicator will change from blue to red.

✱ When the FAN mode is switched to another mode, the compressor will have a protection delay of 1 minute before it starts to work.



COOL mode

✱ The air conditioner enters the COOL mode by default, and the status indicator is blue.

✱ In other modes, press the COOL button to enter the COOL mode. The COOL indicator is on, and other modes are off.



STRONG mode

✱ Press the "STRONG" button, the indicator lights up, and the other mode lights go out.

✱ The air conditioner enters the STRONG mode and works at full load. The air conditioner status indicator is blue.



SLEEP mode

✱ Press the SLEEP mode button, the indicator lights up, and the other mode lights go out.

✱ The air conditioner enters SLEEP mode and works at low load. The air conditioner status indicator is blue.



LIGHT button

✱ Press the LIGHT button, the indicator light is on, the front light is on, and press it again, the light is off.

✱ When the air conditioner is powered on, there is no need to turn on the air conditioner, and the lighting can be turned on or off.

✱ Alternative function Long press for 3 seconds, air outlet temperature display switch between Fahrenheit and Celsius.

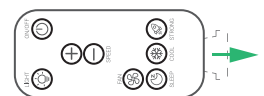

✱ Unplug the plastic sheet and use the remote control.

Multi-Functional Button Control

Car mode

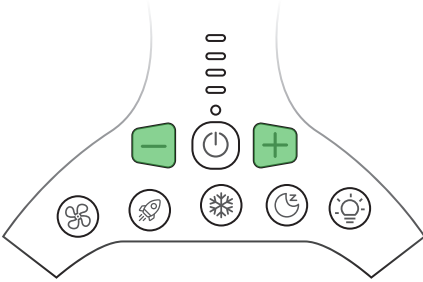

In default mode, when the power supply voltage is lower than 18.6V, the air conditioner will stop working automatically.

Press and hold the "+" and "-" button at the same time (hold for 2 seconds), Mark 2 will enter the car mode (tail indicator light will be purple). In this mode, when the power supply voltage is lower than 22.3V, the air conditioner will automatically power off to prevent the car battery from running out.

When the "+" and "-" button are pressed and hold for 2 seconds again, it switches to the default mode.

LED light off



Press and hold the Fan mode button and "+" button for 2 seconds, all LEDs and temperature display screen will turn off in 60 seconds and they will be reawakened by any press of the button. (This function is designed for those who are particularly sensitive to light when they sleep.)

Press and hold the Fan mode button and "+" button for 2 seconds again, the automatic screen off function will be turned off.

HOW TO USE YOUR MARK 2

Mark 2 can be battery operated or operated with the power adapter.

Tutorial on Operating with the included Adapter.

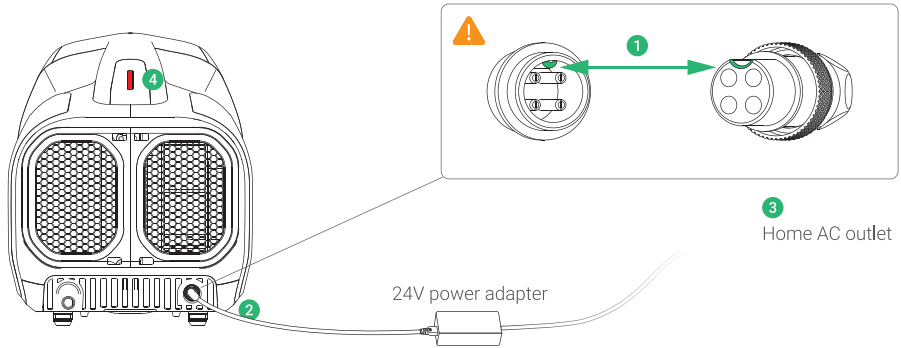

Air conditioning power interface → Mark 2 power adapter → Home AC 100~240V(50Hz/60Hz) → Air conditioner status light is red

 *Use the official adapter provided by Zero Breeze. Do not use a third-party adapter.

Tutorial Battery Operation.

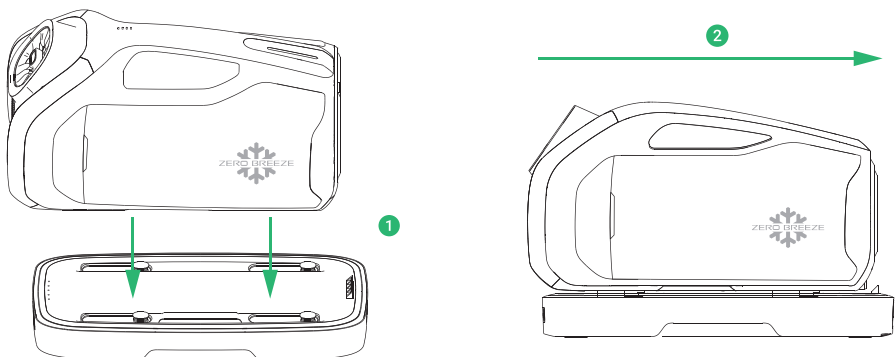

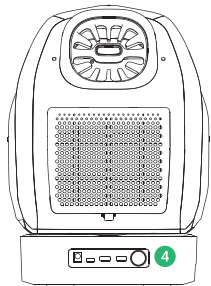
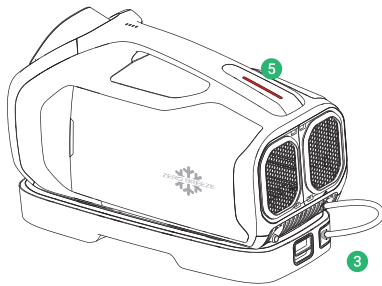

Connect battery instructions

Align the four feet ➡ Pull back ➡ Connect the power cord ➡ Turn on the battery switch ➡ Air conditioner status light is red

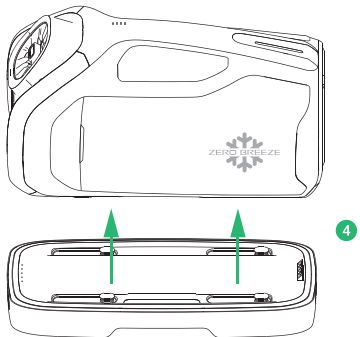
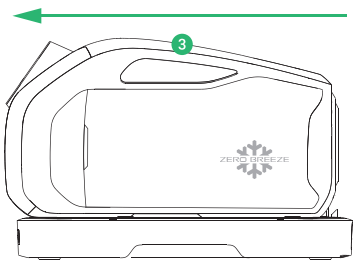
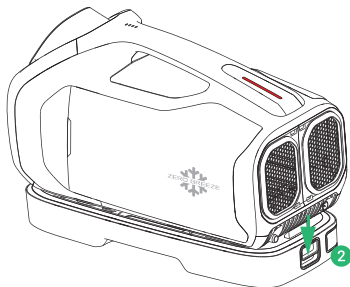
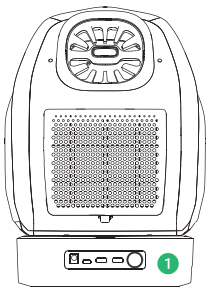

Disconnect battery instructions

Power off the battery ➡ Disconnect the power cord ➡ Press the buckle ➡ Pull forward ➡ Take off

ACCESSORY CONNECTION Drain pipe connection instructions

Zero Breeze Mark 2, like a traditional air conditioner, turns the gaseous water in the air into liquid. It uses gravity to collect and drain the generated water. The inside space can store condensed water for about 1-2 hours, depending on the humidity. It needs you to connect the water pipe with the unit to drain the water to a container/bottle or directly to the ground.

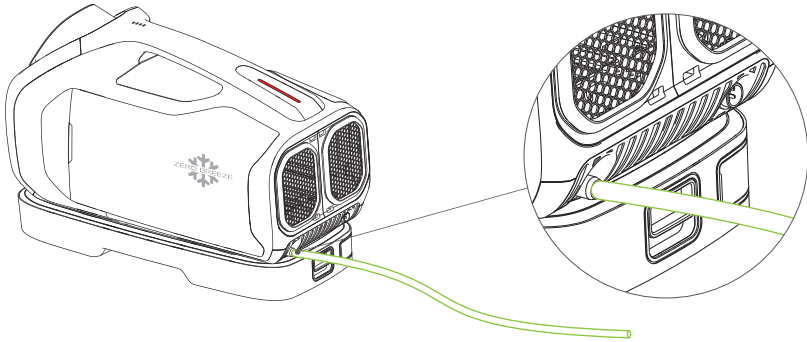

*Take care not to place the drain hose close to the power supply.

*Make sure that the hose is fastened and that there are no leaks and no kinks that impede the flow of water. Make sure that the end of the hose is facing down to allow the water to flow smoothly.

*Do not tilt the Mark 2 forward or sideways when Mark 2 is working or being carried. Otherwise, water may leak from the front or side.

ACCESSORY CONNECTION Exhaust hose connection instructions

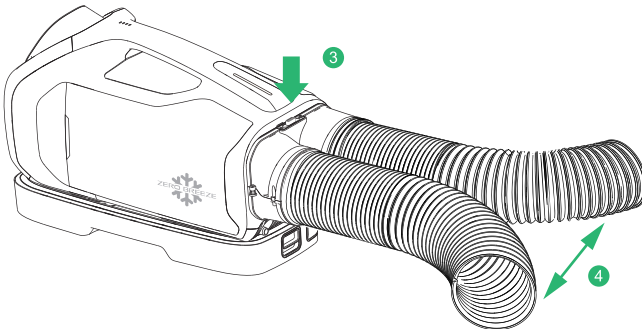
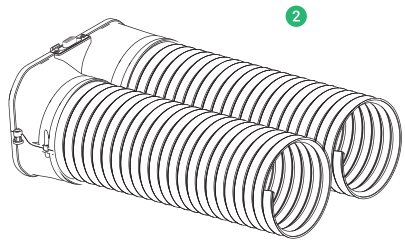
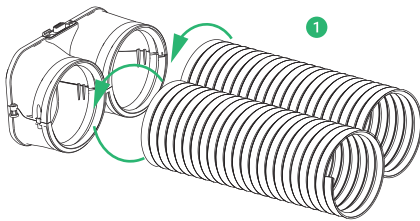

*When using the Mark 2 in a large space or outdoor open space, the Mark 2 is equivalent to a cooler, without the need to connect the exhaust hose.

*When using in a confined space and want to cool down the space, please connect the exhaust hose and place it properly and bend them in the opposite direction.

AIR CONDITIONING USAGE PRECAUTIONS

1. The machine should be kept level when it is in use. It is best to lean it backward 5-10 degrees, not forward or left or right, otherwise the condensate water will leak from the front, side and bottom of the air conditioner.

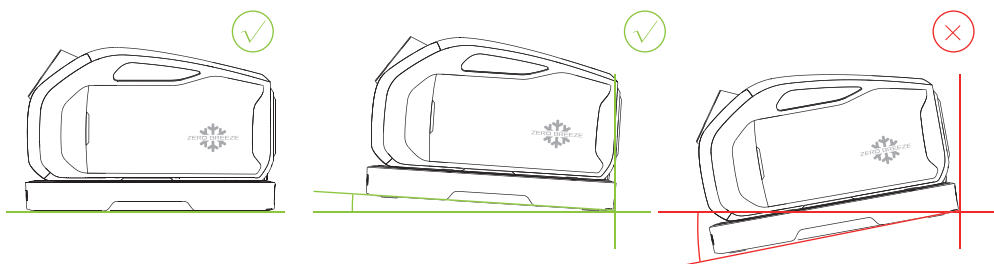

2. Do not move the air conditioner immediately after using the air conditioner. Tilt the air conditioner backwards slowly by 30 degrees to ensure that the water in the air conditioner is drained.

Note: if there is leakage due to improper placement, there is no need to be nervous, just wipe it or cool it naturally, it will not affect the performance of the machine.

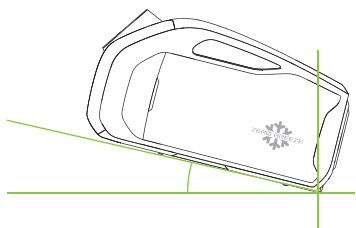

Charging the battery through the power adapter

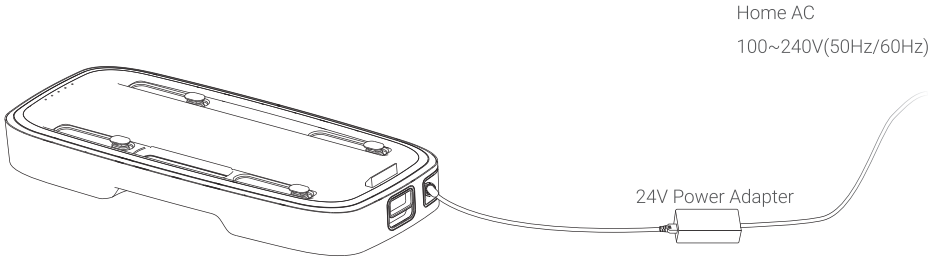

BATTERY charging state

LED1	LED2	LED3	LED4	LED5	Battery level
☀	○	○	○	○	0%-20%
☀	☀	○	○	○	20%-40%
☀	☀	☀	○	○	40%-60%
☀	☀	☀	☀	○	60%-80%
☀	☀	☀	☀	☀	Full



*Zero Breeze will not be held responsible for any consequences caused by charging with chargers not provided by Zero Breeze.

*When the battery level indicators are all on, it means that the battery is fully charged.

*The batteries shown in this manual need to be purchased separately, please refer to the zerobreeze.com for more details.

USE ENVIRONMENT

Your installation location should meet the following requirements:

- Make sure that you install your unit on an even surface to minimize noise and vibration.
- If using with a power adapter, the unit must be put near a grounded plug.
- When Mark 2 is working and the air duct is not connected, make sure that there is no obstruction in the exhaust air inlet and outlet at least 100cm, and there is no obstruction in the front supply air and inlet at least 30cm.
- DO NOT cover the Intakes, Outlets or Remote Signal Receptor of the unit, as this could cause damage to the unit.

Electrical Safety

When using outdoors, pay attention to waterproofing, especially in rainy days. Keep the exhaust and air inlets clear and prevent foreign objects from blocking or inhaling.

Tips:

1. Please leave Mark 2 flat for more than 30 minutes before turning on when it is turned on for the first time, or after long distance or bumpy transportation.
2. Please ensure Mark 2 is placed smoothly, not tilted, not upside down when using it at any time.

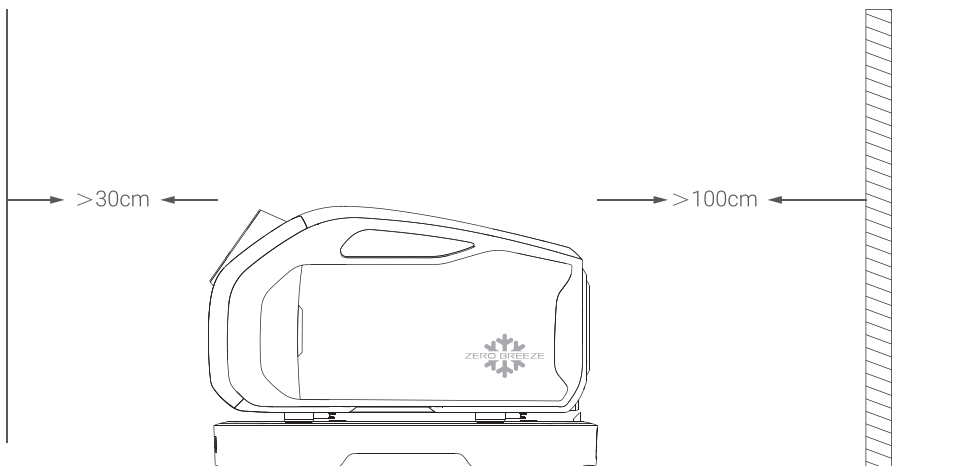

PLACEMENT TIPS

Conventional tent / tent with air conditioning interface

Suggestions:

- Pay attention to tent insulation. If the tent is poorly insulated, cover the tent with an insulated mat.
- Pay attention to the tightness of the tent. For tents with vents, close or cover the vents.
- Pay attention to shade the tent, it is recommended to use it in the shade.
- If it is a large tent, beyond the cooling range of Mark 2, please add one or more air conditioners, or create a small cooling space with a cloth partition in the tent.



WINDOW ACCESSORY INSTALLATION

Tools Needed

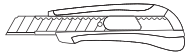

Knife

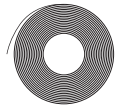

Duct tape

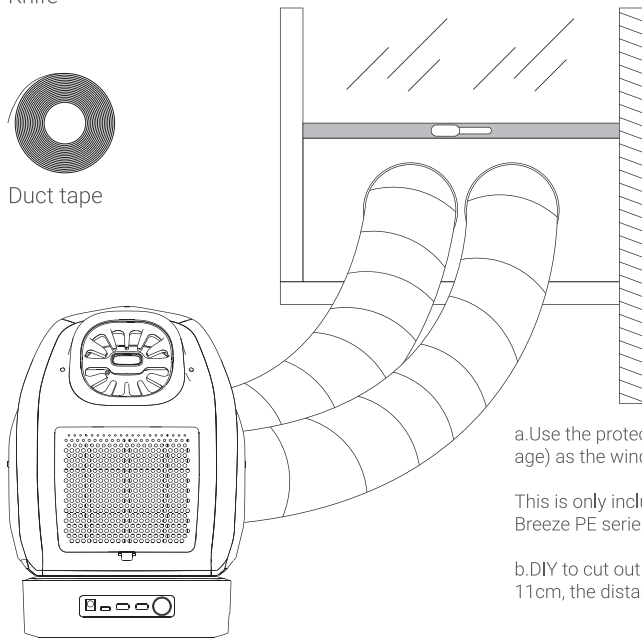
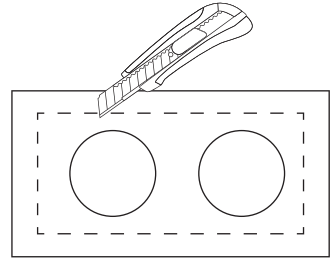
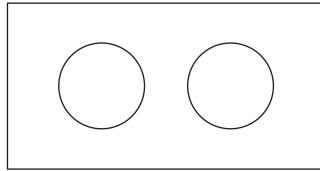

a. Use the protection panel (in the Mark 2 battery package) as the window baffle.

This is only included in Zero Breeze Plus and Zero Breeze PE series.

b. DIY to cut out two circular holes with a diameter of 11cm, the distance of 15cm between each hole.

Use a utility knife to remove the excess. If the width is not enough, cut out some other foam and stitch it together. Choose the right angle and place it on the window. Close the window and insert the two exhaust pipes into the round holes.

Cautions When Placing Exhaust Hoses

- To ensure proper functioning, do not extend or bend the hose excessively.
- Make sure there are no obstacles around the exhaust hose outlet (within 500mm) for the exhaust system to work properly.
- All illustrations in this manual are for illustration only. Your air conditioner may be slightly different depending on the actual product.

COLD AIR EXTENSION PIPE INSTALLATION

* (Not all models include this accessory)

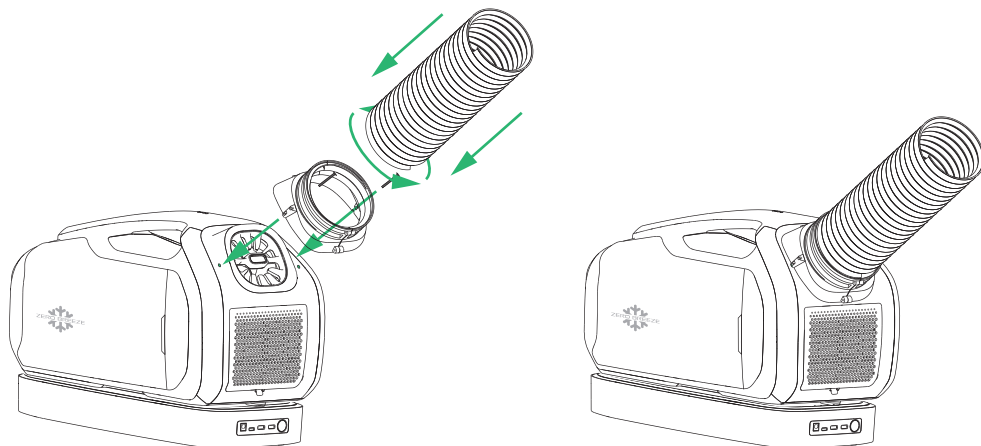

This accessory can be used in some environments, such as the cab, where it is not convenient to place the Mark 2 for cold air to reach the position we want. Remove the 2 rubber plugs on the front panel of Mark 2 and align the adapter with Mark 2. Tighten the two screws, hold the adapter with one hand, and pull the air duct to the desired position.



- When adjusting the position of the cold air pipe, press the extension adapter with the other hand
- Not all models include this accessory

AIR FILTER CLEANING TIPS

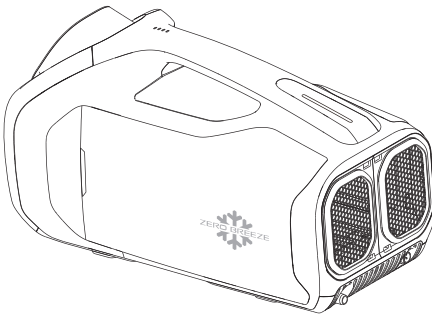
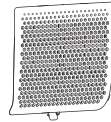
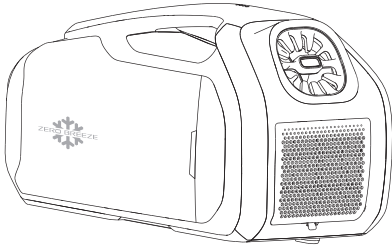

Care and Cleaning

- Always unplug the unit before cleaning or servicing.
- DO NOT use flammable liquids or chemicals to clean the unit.
- DO NOT wash the unit under running water. Doing so causes electrical danger.
- DO NOT operate the machine if the power supply was damaged during cleaning. A damaged power cord must be replaced with a new cord from the manufacturer.
- Always clean the unit using a damp, lint-free cloth and mild detergent. Dry the unit with a dry, lint-free cloth.
- Drain the unit's water collection tray by tilting the machine backwards.
- After draining the water run the unit on FAN mode for 12 hours in a warm room to dry it and prevent mold.
- Turn off the unit and unplug it.
- Clean the air filter . Always reinstall the clean, dry filter before storing.

MALFUNCTION DIAGNOSIS

Trouble Shooting Tips

Symptom	Possible Cause	Solution
Unit does not cool well	The air conditioner doesn't work at COOL or STRONG mode.	Set the working mode to COOL or STRONG mode.
	The air filter is blocked with dust or animal hair.	Turn off the unit and clean the filter according to instructions.
	Exhaust hose is not connected or is blocked.	Turn off the unit, disconnect the hose, check for blockage and reconnect the hose.
	The unit is low on refrigerant.	Contact the consumer service.
	The windows and doors in the room are open.	Make sure all windows and doors are closed.
	The room area is too large.	Double-check the cooling area.
	There are heat sources inside the room.	Remove the heat sources if possible.
	The floor is not level.	Place the unit on a flat, level surface.
The unit is noisy and vibrates too much	The air filter is blocked with dust or animal hair.	Turn off the unit and clean the filter according to instructions.
The unit makes a gurgling sound	This sound is caused by the flow of refrigerant inside the unit.	This is normal.
Unit stops frequently	The exhaust hose is blocked, extended or otherwise restricted.	Remove the exhaust hose to see if the unit continues to operate. If yes, shorten the extension, reduce the number of bends or eliminate restriction.

Fault error code and handling

Except E02 and E03 will be auto displayed, it needs you to long press the Fan mode key and the Wind Speed - key for 2 seconds to query for the following error code, and long press the Fan mode key and the Wind Speed - key again for 2 seconds to exit displaying the code.

Error Code	Error Description	Troubleshooting	Solution
E00	Drive Board Communication Failure	Unit shuts off	Contact the consumer service.
E01	Temperature Sensor Faulty	The air conditioner will continue to run, but the temperature will not be displayed, and "--" will be displayed instead.	Contact the consumer service.
E02	Over Voltage Protection	Unit shuts off, buzzer alarms, and tail LED light flashes, when the power source is over 31.5V.	Use the power source with input voltage less than 31.5V.
E03	Low Voltage Protection	Unit shuts off, buzzer alarms, and tail LED light flashes. The battery runs out. And in normal mode: the output voltage is lower than 18.6V; in vehicle mode: the output voltage is lower than 22.3V.	Charge the battery to make the output voltage meet the input requirement of the Mark 2 AC.
E04	Phase protection	Unit shuts off	Contact the consumer service.
E05	Stalling Protection	Unit shuts off	Contact the consumer service.
E06	Abnormal Phase Current Protection	Unit shuts off	Contact the consumer service.
E07	Over Current Protection in Software	Unit shuts off and continue to run after troubleshooting	Contact the consumer service.
E08	Over Current Protection in Hardware	Unit shuts off	Contact the consumer service.

Fault error code and handling

Except E02 and E03 will be auto displayed, it needs you to long press the Fan mode key and the Wind Speed - key for 2 seconds to query for the following error code, and long press the Fan mode key and the Wind Speed - key again for 2 seconds to exit displaying the code.

Error Code	Error Description	Troubleshooting	Solution
E09	Tilting Switch Protection	Unit shuts off and continue to run after troubleshooting	Contact the consumer service.
E10	Rear Fan Feedback Failure	Abnormal feedback for 20 consecutive seconds, stop for 5 seconds, and then start; Stop trying to start after 3 times.	Contact the consumer service.
E11	Front Fan Feedback Failure	Abnormal feedback for 20 consecutive seconds, stop for 5 seconds, and then start; Stop trying to start after 3 times.	Contact the consumer service

SPECIFICATION

Air Conditioner Specification

Working Mode	Cool, Fan(4 level), Sleep, Super Cold
Wind Speed Level	4
Sound Level	52dB(A)
Cooling Capacity	650W
Climate Type	T1
Cooling Rated Input:	240W
Rated Voltage:	24V DC
Unit Size	20"L x 10"W x 11"H
Weight	16.5lb
Moisture Protection	IPX4
Vent Hose Exhaust Configuration	Dual Hose

WHAT'S IN THE BOX

Check that all of the following items are in your package. If any items are missing, please contact Zero Breeze™ or your local dealer.

Zero Breeze Mark 2 Air Conditioner x 1

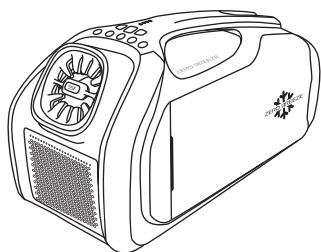

24V output 240W Power Adapter x 1

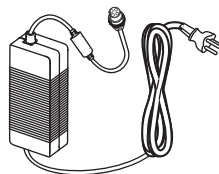

80cm Drainage Pipe x 1



80cm Front Air Outlet Duct x 1

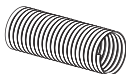

Front Air Outlet Duct Connection Adapter x 1



120cm Venting Hose x 2

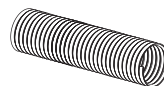

Venting Hose Connection Adapter x 1

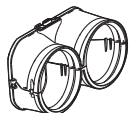

IR Remote Controller x 1



Zero Breeze Mark 2 User guide X 1



Screw for Front Air Outlet Duct Connection Adapter X 2



ZERO BREEZE is a trademark of Zero Breeze.
Copyright©2020 Zero Breeze All Rights Reserved.

Printed in China.



Video Tutorial

Visit our official website to watch a video tutorial at www.zerobreeze.com

Warning: Before using this product, please read this manual carefully and keep it for future reference.

The design and specifications are subject to change without prior notice for product improvement.

Consult with your dealer or manufacturer for details.