

2

1



**Hole Identification**

1/4 - 20 TYP x 2 (A)

5/16 - 18 TYP x 2 (B)

3/8 - 16 TYP x 2 (C)

Unthreaded: 2.66 thru, .4375 counterbore x10 (D)

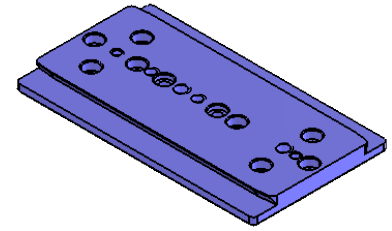

B

B

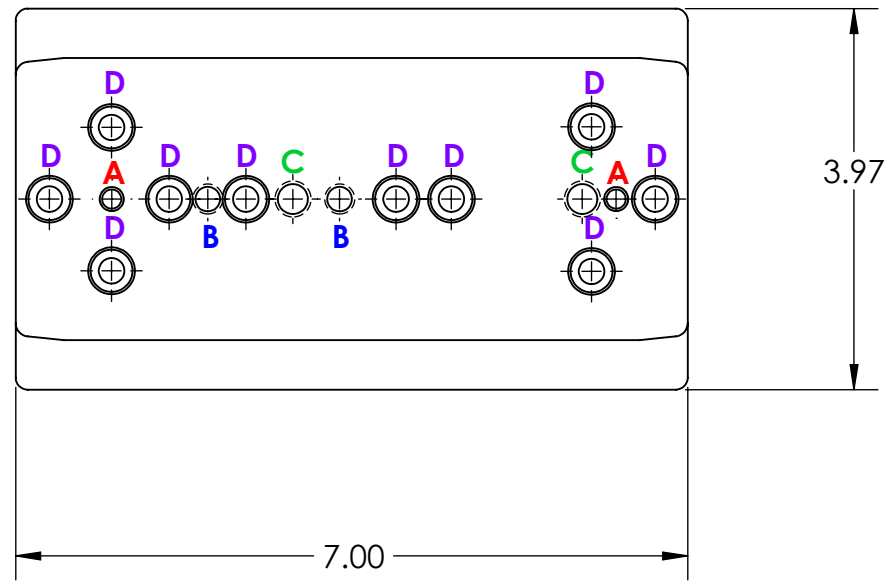

A

A



FDUPS

2

1

2

1



1/4-20 Hole Spacing

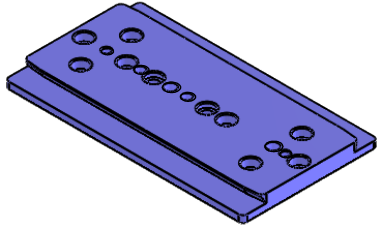

B

B

1.00in  
25.4mm

5.26in  
133.5mm

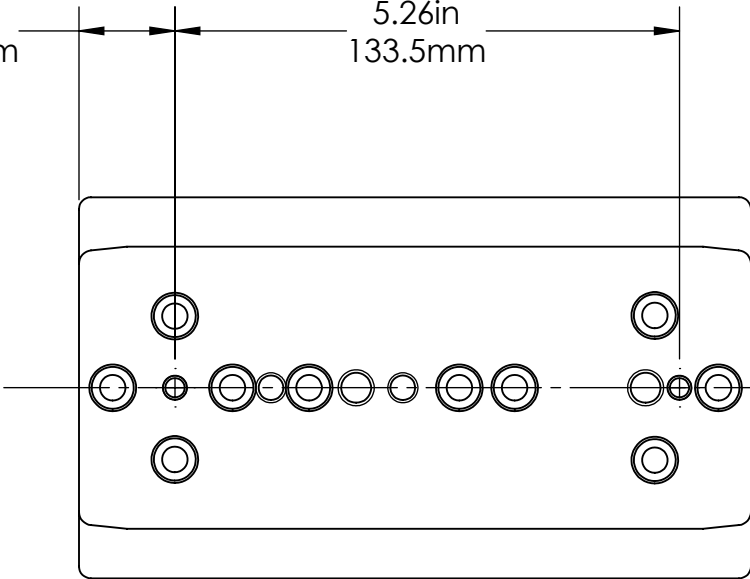

A

A



FDUPS

2

1

2

1



5/16-18 Hole Spacing

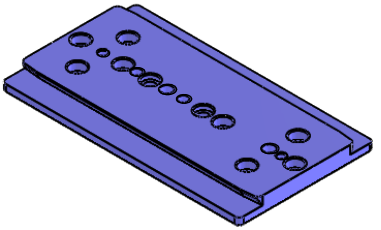

B

B

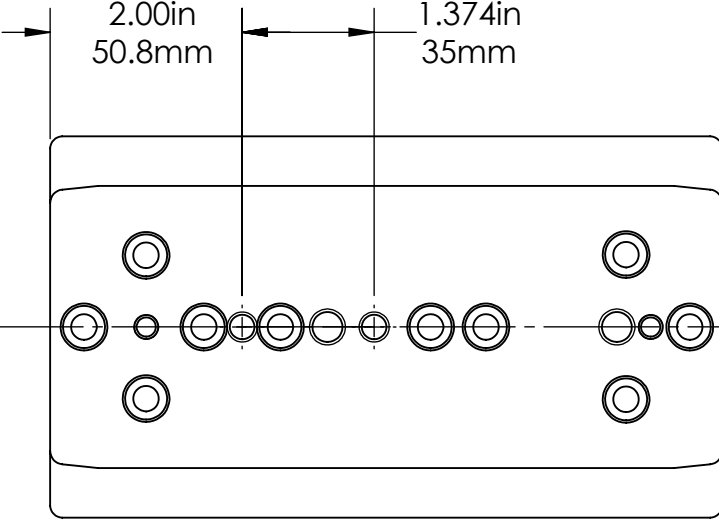

A

A



FDUPS

2

1

2

1



3/8-16 Hole Spacing

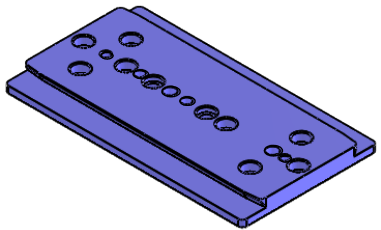

B

B

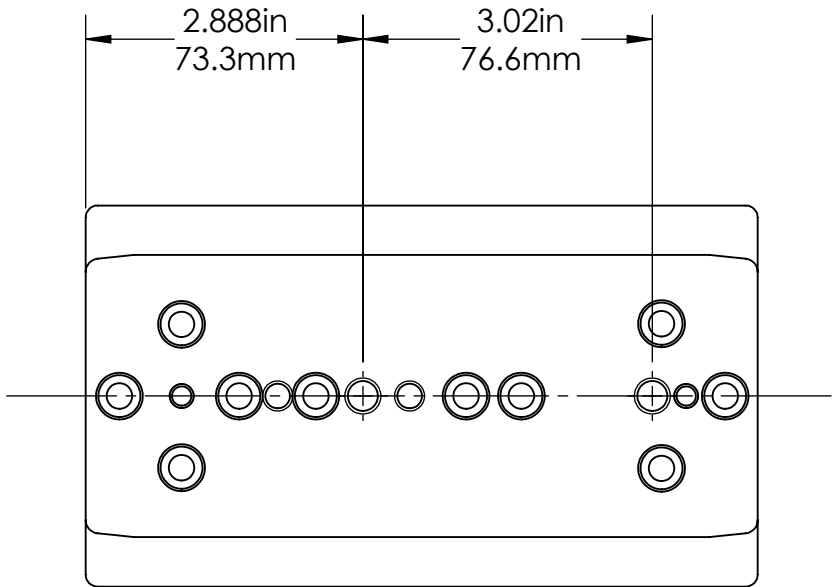

A

A



FDUPS

2

1

2

1



Unthreaded Hole Spacing

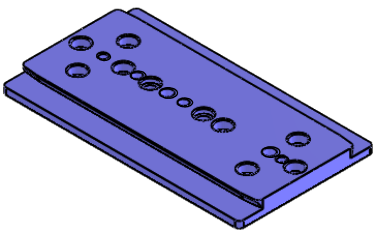

B

B

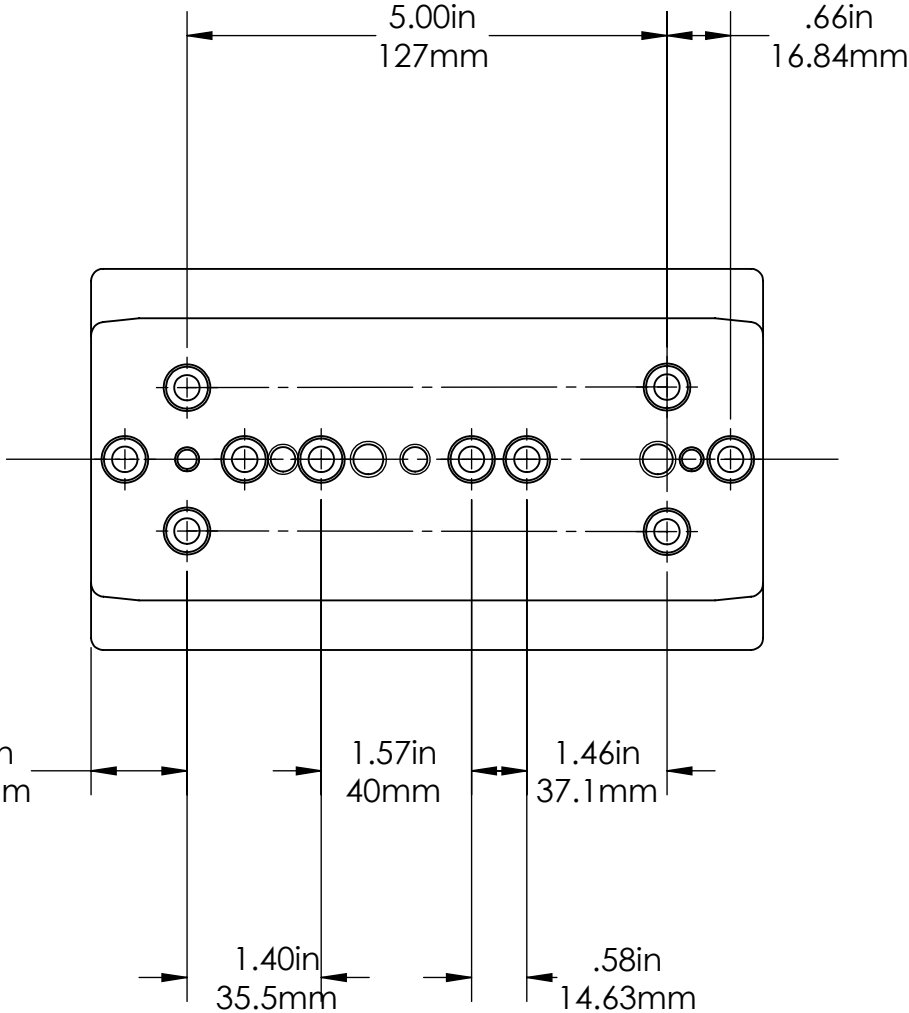

A

A



FDUPS

2

1