



www.petlibro.com



Model: PLWF005

USER MANUAL

Dockstream Automatic Pet Water Fountain

DOCKSTREAM

Automatic Pet Water Fountain

Model: PLWF005

©Libro Corp. All Rights Reserved.

Manufacturer: Shenzhen Libro Technology Co., Ltd.

Address: 12/F, Tower B, GALAXY WORLD, Yabao Road,
Longgang District, Shenzhen, China

JP Importer: 株式会社神州

Made in China

PLWF005_V1.0

IC: 28987-PLWF005

FCC-ID: 2A3DE-PLWF005

CAN ICES-3 (B)/NMB-3(B)



This device complies with Part 15 of the FCC Rules. Operation is subject to the following two conditions: (1) this device may not cause harmful interference, and (2) this device must accept any interference received, including interference that may cause undesired operation.

Before using the product, please read this manual thoroughly and retain it for future reference.

CONTENTS

SAFETY PRECAUTIONS	01
WARRANTY	04
PRODUCT OVERVIEW	05
HOW TO USE	07
CARE INSTRUCTIONS	10
TROUBLESHOOTING	11
SPECIFICATIONS	12

SAFETY PRECAUTIONS

! Warning

- Dispose of all packaging materials properly. Keep the polybags away from children and pets as these bags could cause suffocation.
- Do NOT allow children to play with, in or around the pet water fountain.
- To avoid injury, please keep close supervision when the appliance is used near children.
- Do NOT use the water fountain with pets not able to reach the water tray or with any physical disability.
- Do NOT place any foreign object in the water tank.
- Do NOT disassemble the pet fountain other than components as instructed in this User Manual.
- Do NOT use the pet fountain for anything other than its intended use.
- Only use attachments recommended or sold by the manufacturer. The use of attachments not recommended or sold by the manufacturer may cause an unsafe condition. Do NOT modify the pet fountain.
- Do NOT operate any appliance if the unit is malfunctioning or has been damaged. Do not attempt repairs on the device yourself. Contact our customer service immediately for further instructions.
- Be sure to disconnect the power supply for safety when the appliance is not in use.
- Please disconnect the power supply before maintaining and cleaning the machine.
- Always unplug the appliance when not in use; or before putting on or taking off parts and before cleaning.
- The power adapter and wire plug must not be flooded during cleaning.

- This product is for indoor use only.
- This product is not allowed to run without water.
- Never pull the electrical power cord to remove the plug from the wall outlet.
- If the plug of this device gets wet, turn off the electricity of that wall outlet. Do NOT attempt to unplug.
- Check the device after installation. Do NOT plug in if there is water on the contact points or plug.
- To avoid tripping, always position the power cord out of the way of foot traffic.
- Do not use the appliance in the bathroom.
- Replace the filter at least once every 2 weeks or when the flow rate has noticeably reduced. For two or more cats, you may need to replace the filters more regularly if it becomes blocked.
- Do not put any parts of the whole machine into the dishwasher, otherwise, there is a risk of deformation.

CAUTION

- Do NOT allow pets to chew on or swallow any parts. If you are concerned about the power cord, purchase a cord conduit (a hard-plastic protector) at any hardware store to protect the power cord.
- If an extension cord is necessary, one unit with a proper rating should be used.
- Do NOT install or store the pet water fountain where it will be exposed to weather or temperatures below 0° C / 40°F.
- Read and observe all important notices listed on the pet water fountain and in the packaging.

This device complies with Part 15 of the FCC Rules. Operation is subject to the following two conditions:

- (1) this device may not cause harmful interference, and
- (2) this device must accept any interference received, including interference that may cause undesired operation.

Changes or modifications to this unit not expressly approved by the party responsible for compliance could void the user's authority to operate the equipment.

NOTE:

This equipment has been tested and found to comply with the limits for a Class B digital device, pursuant to Part 15 of the FCC Rules. These limits are designed to provide reasonable protection against harmful interference in a residential installation. This equipment generates, uses and can radiate radio frequency energy and, if not installed and used in accordance with the instructions, may cause harmful interference to radio communications. However, there is no guarantee that interference will not occur in a particular installation. If this equipment does cause harmful interference to radio or television reception, which can be determined by turning the equipment off and on, the user is encouraged to try to correct the interference by one or more of the following measures:

- Reorient or relocate the receiving antenna.
- Increase the separation between the equipment and receiver.
- Connect the equipment into an outlet on a circuit different from that to which the receiver is connected.
- Consult the dealer or an experienced radio/TV technician for help.

This device and its antenna(s) must not be co-located or operation in conjunction with any other antenna or transmitter.

Radiation Exposure Statement

To maintain compliance with FCC's RF Exposure guidelines, This equipment should be installed and operated with minimum distance of 20cm from your body.

WARRANTY

- 1-year warranty
- Lifetime support

For guidance on product use and warranty extension, please contact our brand after-sales staff via email: **support@petlibro.com**

If any questions related to orders, please contact the seller through the shopping platform.

PRODUCT OVERVIEW

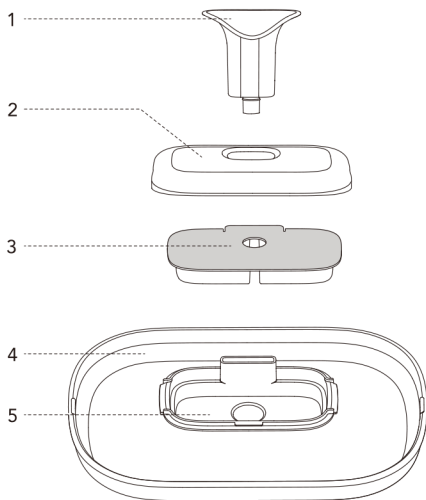

- 1. Spout
- 2. Filter Lid
- 3. Filter
- 4. Water Tray
- 5. Filter Tray

Note: Components 4 and 5 are integrated and cannot be detachable.

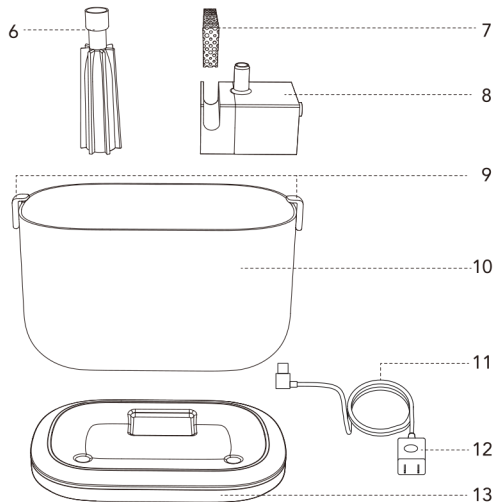

- 6. Water Pipe
- 7. Foam Filter
- 8. Wireless Water Pump
- 9. Snap Lids
- 10. Water Tank
- 11. Power Cord
- 12. Power Adapter
- 13. Tank Base

Note: Components 9 and 10 are integrated and cannot be detachable.

HOW TO USE

1. Soak the filter in a clean bowl for 5 minutes, then rinse the filter thoroughly with tap water.

Notes:

1)The filter must be fully soaked before the fountain is turned on; otherwise, the water may not flow through the filter smoothly and cause spillage.

2)Do not soak the filter in the water tank of the fountain in case of any surface dust.

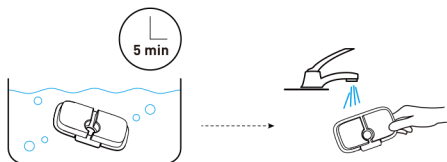

2. Insert the foam filter into the groove of the water pump. Position the pump according to the bottom slot shape.

Note: Please pay attention to aligning the recessed part of the pump with the protruding part of the water tank, otherwise the pump cannot be installed firmly.

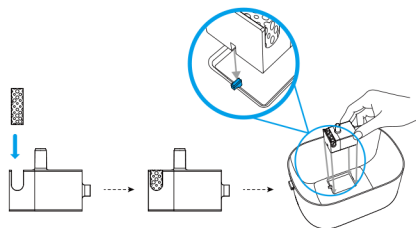

3. Install the silicone pipe on the pump. Add water to the tank.

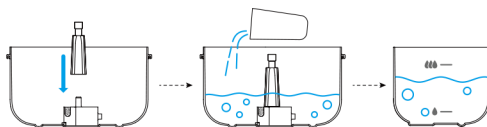

4. Install the water tray and fasten the snap lids.

Note: Pass the water pipe through the hole of the water tray, and the snap lids of the water tray need to be fastened, otherwise it will loosen.

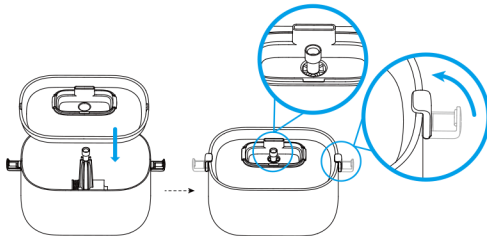

5. Install the soaked filter.

Note: Please make sure the hole of the water pipe passes through the hole of the filter.

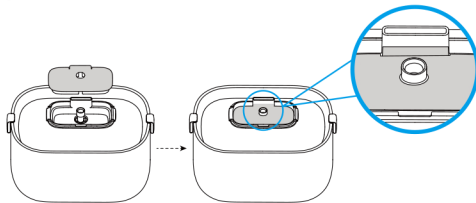

6. Install the filter lid. Whether to install the spout depends on your pet's drinking preference.

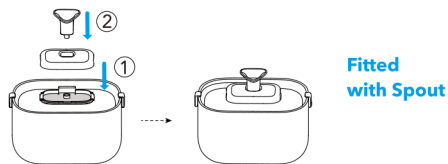
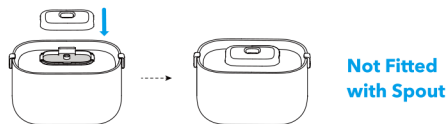

7. Connect the power adapter.

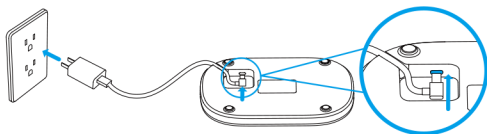

8. Install the water tank with the tank base by aligning the protruding hole of the water tank with the tank base.

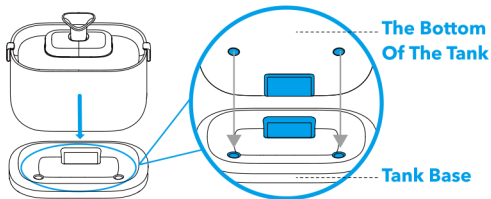

CARE INSTRUCTIONS

1. Replace the filter and the foam filter at least once every 2 weeks.
2. Clean the pump and fountain at least once every 2 weeks.

How to clean the pump

1. Remove the foam filter, pump cover and impeller cover in sequence.

Note:

The foam filter affects the water yield very much, so please clean it frequently and replace it in time when cleaning the pump.

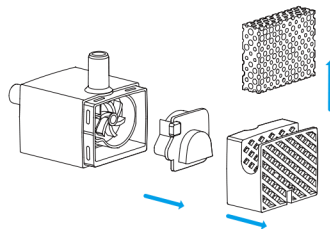

2. Remove the impeller by the brush hook.

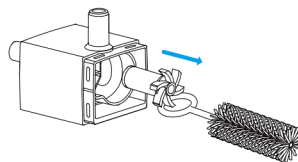

3. Use the brush to clean the parts with water.

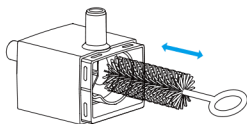

Tip: The brush can also be used to clean the spout. Recommended to clean the spout every 2 weeks.

TROUBLESHOOTING

Problem	Solution
Water keeps spilling out of the water tray.	The filter may not be fully soaked. Please soak the filter in a clean bowl (not in the water tank) for 5 minutes before the first use.
The pump stops working.	1) Fill in water between MIN and MAX. The pump will fail if it runs dry. 2) Clean the pump, water tank, and drinking basin. 3) If the above solutions don't work, please contact us at support@petlibro.com
How often should I change the filters? Where to get them?	Please replace the filter at least once every 2 weeks. support@petlibro.com to purchase new filters.
Why do I need to soak the filter before first use?	The filters absorb more water (and therefore clean more water) when they're wet and expanded. Soaking the filter removes particulate matter that may have settled on the filter.
Water output speed slows down.	1) For the first use (or reuse after long-time storage), the water pump needs to discharge air, it's normal if the water output speed slows down.

Problem	Solution
Water output speed slows down.	2) It is dirt in the pump, please refer to "How to Clean the Pump" in the manual to clean it.
No water after installation	This product adopts a wireless pump, and the power supply mode of the water pump is induction power supply. Please ensure that the power supply is connected, the water tank and base are installed correctly, and the water pump and water tank are installed correctly. Please refer to the "How to Use" section of the manual.
Black residues and dirt appear in the water tank and on the filter element	1) Please ensure that clean water sources are replaced regularly. 2) Please make sure to soak and wash the filter element in advance.

SPECIFICATIONS

Model	PLWF005
Power Adapter	Input: 100-240V 50/60Hz Output: 5V/1A
Material	ABS / stainless steel
Water Tank Capacity	2.5 L
Dimensions	232x177x161 mm / 9.1x7x6.3 inch
Net Weight	756g / 26.7oz