

# INSTALLATION INSTRUCTIONS

# Joie™

## gemm™

MODEL I 0911 F

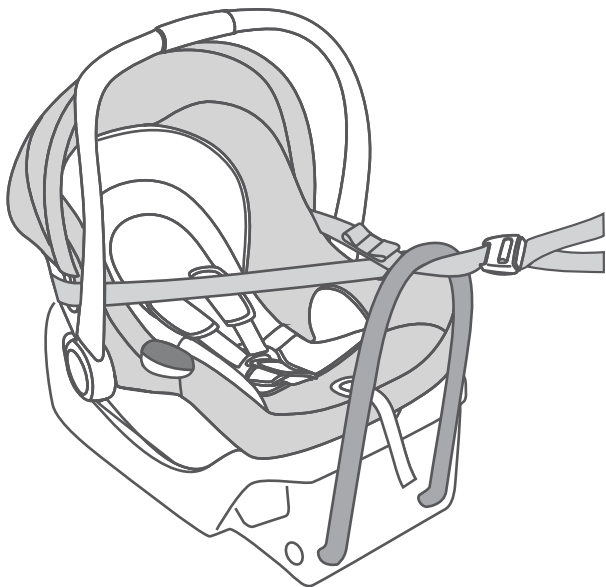

**IMPORTANT: KEEP THIS INSTRUCTION BOOKLET IN  
THE PLACE PROVIDED ON THE CHILD RESTRAINT**

This Child Restraint is suitable for children up to approximately 6 months of age.



Before installation and use of this child restraint check that it is suitable for the size of your child. See pages 7 & 8 of the USE Instructions for more information.

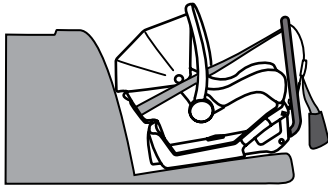

**This is a rear facing child restraint. Do not face forward.**

Distributed by Nuna Baby Australia Pty. Ltd.

ACN: 642 240 140

Unit 1, 35 Lyn Parade Prestons, NSW Australia 2170

For after-sales & warranty service, contact:

1800 951 070 [customerservice@nunababy.com.au](mailto:customerservice@nunababy.com.au)

Keep these Instructions for future reference.

# Contents

Quick Reference .....	2
<b>WARNINGS</b> .....	3
<b>Additional Warnings</b> .....	4 & 5
Features .....	6
Installation - General .....	7 & 8
Installation - Vehicle Belts .....	9 - 11
<b>Checklist</b> - Vehicle Belt Installation .....	11
Fitting Restraint to Base.....	12
<b>WARNINGS</b> – Tether Strap .....	13
How to use the Tether Strap .....	14 - 16
<b>Checklist</b> - Tether Strap .....	17
Installation – Tether Anchorage.....	18 - 20
Use with Strollers .....	21
Cleaning and Maintenance .....	22

**DO NOT USE THIS CHILD RESTRAINT UNTIL YOU HAVE READ AND UNDERSTOOD THE INSTRUCTIONS IN THIS USER GUIDE AND IN YOUR VEHICLE OWNERS MANUAL**

# Quick Reference

**IMPORTANT:** Also read the following instructions carefully

## Tether Strap

must always be used when the restraint is installed in a vehicle. Store end of tether in bag. See pages 14 - 16

## Carry Handle

must always be locked into position.

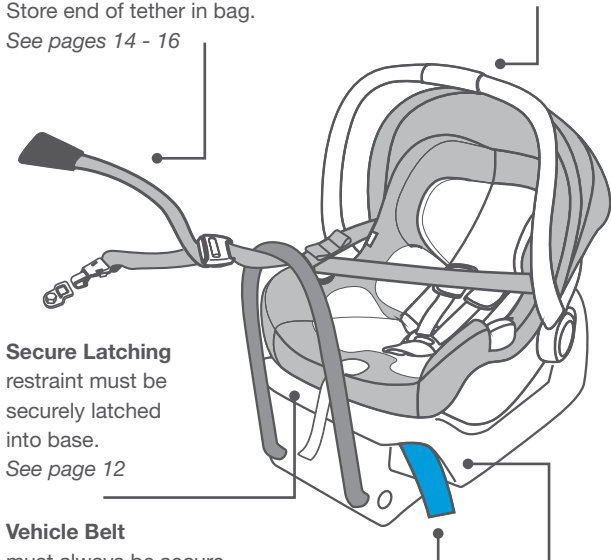

## Secure Latching

restraint must be securely latched into base. See page 12

## Vehicle Belt

must always be secure and pulled tight. See pages 10 & 11

## Base Recline Adjustment

base must be reclined correctly See pages 7 & 8

Read the whole of these instructions carefully and if there is any doubt about the method of installation, consult the child restraint manufacturer or agent, or a child restraint fitting station authorized by the relevant transport authority, or in New Zealand an agent for the vehicle.

## **⚠** WARNINGS

- Use the restraint exactly as shown in the instructions.
- Fit the restraint firmly to the car seat.
- A loose harness or restraint is dangerous.
- Destroy the restraint if it has been in a severe crash, even if no damage is visible.
- Do not alter or modify this restraint.
- Repairs must only be done by the manufacturer or agent.
- This child restraint is not approved for use with any connectors that connect to the car's ISOFIX low anchorages.
- **DO NOT USE A REAR FACING CHILD RESTRAINT WHERE AN AIRBAG IS FITTED IN FRONT OF THE SEATING POSITION.**
- Only use this restraint with the base it was supplied with. If a second or replacement base is required it must be a matching model number.

**NOTE:** The warnings on these pages are those required by the Australian and New Zealand Standard AS/NZS 1754 for this type of child restraint. Other warnings specific to this particular child restraint will be found throughout these instructions.

## ADDITIONAL WARNINGS

TO BE USED WITH A LAP-SASH/LAP ONLY SEATBELT IN THE BACK OF MOST CARS WITH FORWARD FACING SEATS.

This restraint is 700 mm long, 440 mm wide and 480 mm high (with the handle down). Check the measurement between the front of the seat back of the rear seat and all front seats in the car in which the restraint is intended to be used to ensure the space available is sufficient.

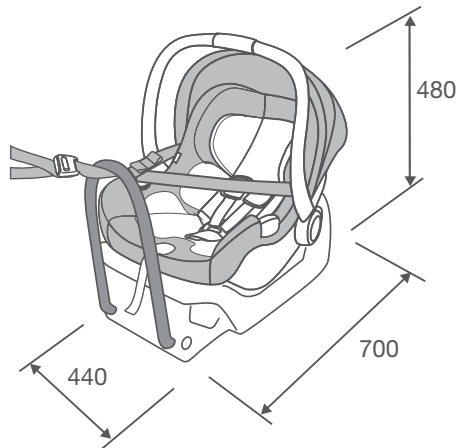

Seat belt extenders are not recommended if the car seat belt is too short to secure the child restraint. If the car seat belt is too short get advice from a child restraint fitter regarding use of these.

## ADDITIONAL WARNINGS

Only install child restraint in a forward facing vehicle seat. Never install in a seat that faces the rear or the side of the vehicle.

This is a rearward facing child restraint. Do not install facing the side or forwards.

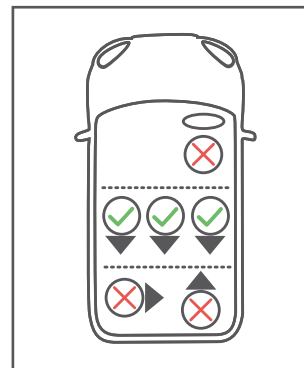

Never install the Child Restraint in a seat with a front airbag. DEATH or SERIOUS INJURY may occur. Refer to your vehicle Owners Manual for airbag warnings and information.



Always check child restraint to base connection.

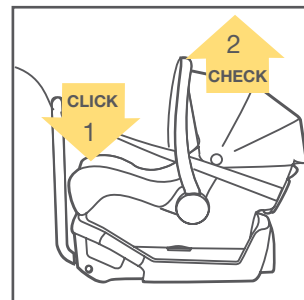

# Features

- 1 Tether Strap
- 2 Child Restraint Release Lever
- 3 Snap Hook
- 4 Tether Strap Anchorage
- 5 Tether end storage
- 6 Rebound Bar
- 7 Vehicle Belt Lock-Off
- 8 Bubble Level Indicator
- 9 Instruction Manual Storage
- 10 Recline Foot
- 11 Recline Foot Fold Latch

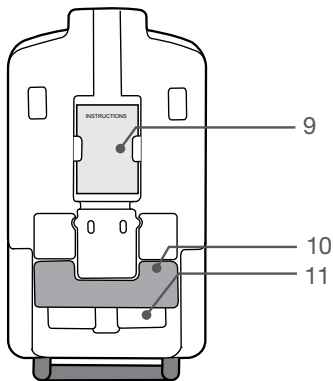
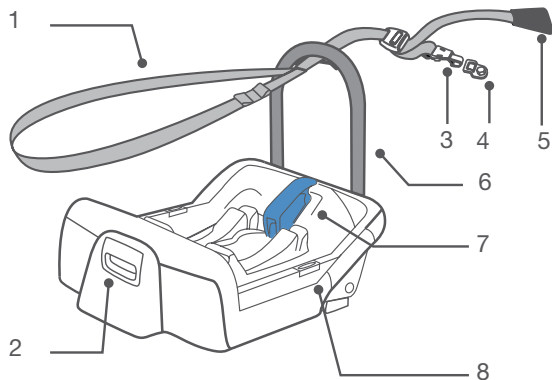

# Installation - General

## Where to install the child restraint?

Only install the child restraint in a forward facing vehicle seat.

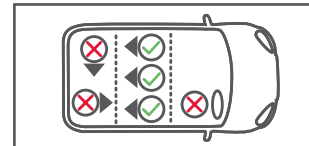

Do not install in a seat that faces the rear or the side of the vehicle.

Install in the rear seat, the safest place is normally the centre.

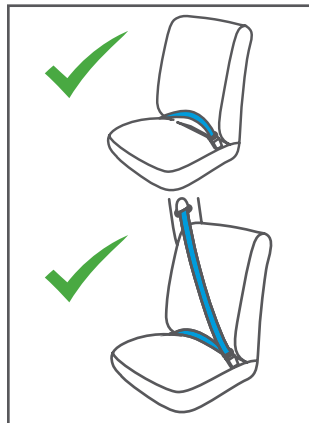

The base can be installed on vehicle seats fitted with either a lap belt or a lap/sash belt.

To install correctly the vehicle must be on a level surface.

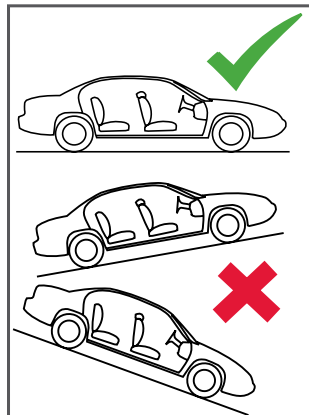

**IMPORTANT:**  
Correct position and installation is essential for your child's safety.

# Installation - General

- 1 Position base on a forward facing vehicle seat.

Adjust base so bubble is between the black patches.

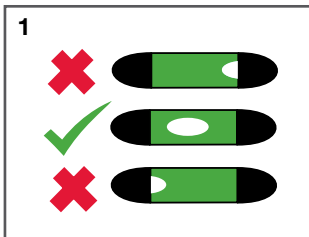

- 2 Use recline adjustment, if needed, to achieve correct angle for installation.

Recline adjustment foot snaps into position.

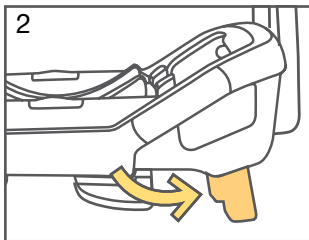

- 3 If the recline adjustment foot does not give sufficient recline, add a folded towel or similar firm padding.

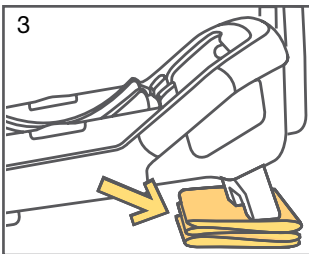

## IMPORTANT:

Any extra padding placed under the base must be firmly folded so that when the vehicle belts are pulled up tight, the base is secure.

Always secure the base with a vehicle belt, even when the restraint is not fitted to it.

An unsecured base may be dangerous in an accident or sudden stop.

# Installation — Vehicle Belts

Use the Belt Path labels as a guide for correct belt placement.



## REARWARD-FACING BELT PATH

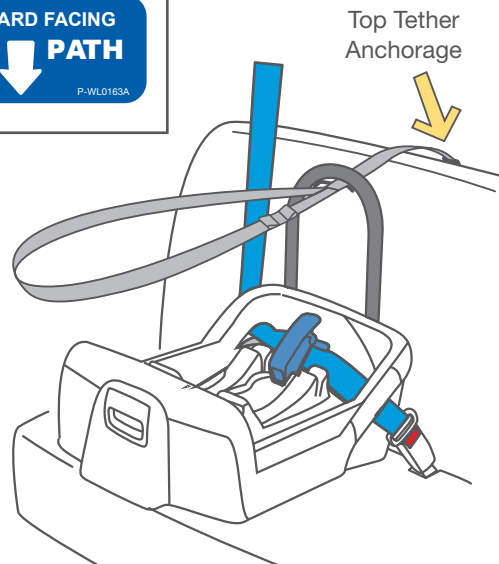

INSTALLED BASE

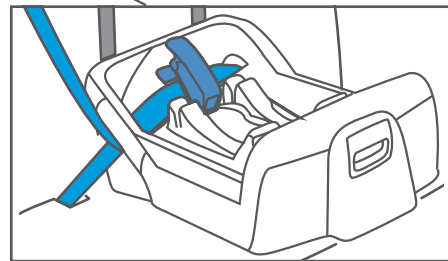

# Installation — Vehicle Belts

Place the base on the vehicle seat in line with a top tether anchorage point.

1. Open the belt lockoff.

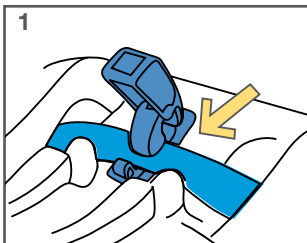

2. Pass the vehicle belt through the openings in the base labeled 'BELT PATH'

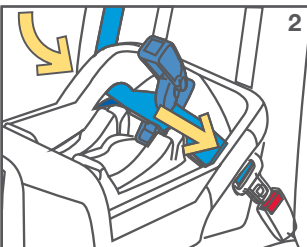

3. Buckle the vehicle belt.

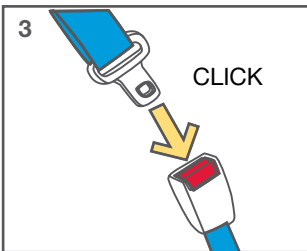

4. Push the base into the vehicle seat firmly **A** and pull the vehicle belts tight **B**.

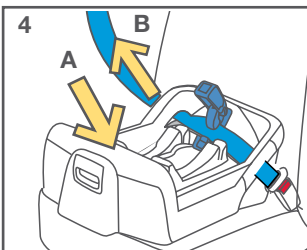

**IMPORTANT**  
Belts must not be twisted.

5. Hold vehicle belts tight and engage the belt lockoff.

**BELTS MUST BE TIGHT.**  
**LOOSE BELTS ARE DANGEROUS.**

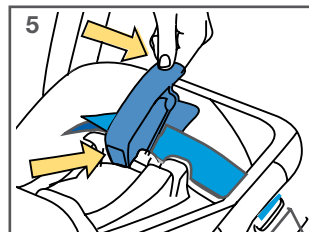

## Checklist — Vehicle Belt Installation

1. Vehicle Buckle engaged.

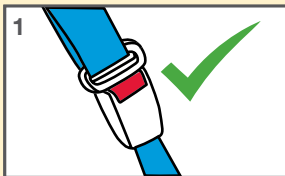

2. Vehicle belt is tight.

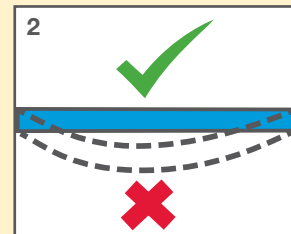

3. Vehicle belt is not twisted.

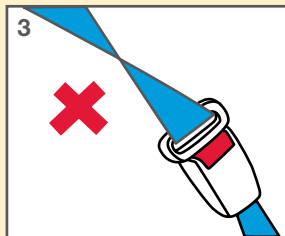

4. Level indicator bubble is fully in the clear area.

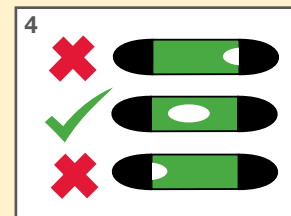

# Fitting Restraint to Base

## To Install

First make sure there is nothing in or on the base (blankets, toys etc).

These may stop the restraint from latching securely.

Lower the restraint down into the base. Listen for a "CLICK" from the latches in the base.

Pull up on the restraint to ensure it is securely latched.

## To Release

Lift the restraint with one hand while pulling up on the release latch at the back of the base.

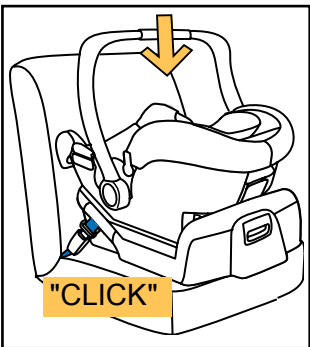
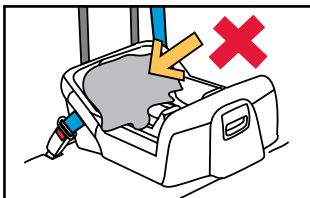

## ⚠ WARNINGS

### TETHER STRAP

THIS RESTRAINT MUST BE ATTACHED TO A CHILD RESTRAINT UPPER ANCHORAGE POINT IN THE CAR.

REFER TO CAR OWNERS HANDBOOK FOR LOCATION OF ANCHORAGE POINTS.

REFER TO A CHILD RESTRAINT FITTING STATION IF NO ANCHORAGE POINTS ARE IN THE MOTOR CAR.

THIS RESTRAINT IS NOT SUITABLE FOR USE WHERE THE TOP TETHER STRAP MAY FALL INTO A SPLIT IN THE SEAT BACK OR OFF THE SIDE OF THE SEAT.

Always secure the loose end of the top tether strap to prevent it hanging out of the car or being accessible by the child. It should be stored in the bag provided on the end of the strap.

Do not use the child restraint where this strap may fall into a split in the seat back or off the side of the seat.

ALWAYS ATTACH HOOK AND REMOVE SLACK.

**CAUTION: CHILDREN CAN BE INJURED OR RESTRAINTS AND TOP TETHER STRAP DAMAGED BY UNSECURED CARGO IN A COLLISION. SECURE OR REMOVE HAZARDOUS CARGO BEFORE USING THIS CHILD RESTRAINT.**



## How to use the Tether Strap

Always use the tether strap.

Connect the tether strap to the built-in anchorage fitting in the vehicle, or if there is not one available, install the anchor fitting supplied with this restraint.

Store the extra webbing in the bag attached to the end of the tether.

**NOTE:** the tether strap wraps around the sides of the restraint, not over the top.  
If the canopy is fitted the tether passes outside it.

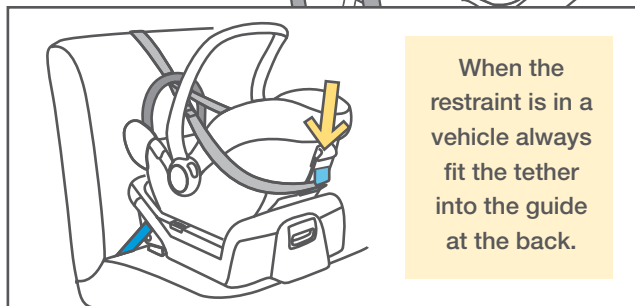
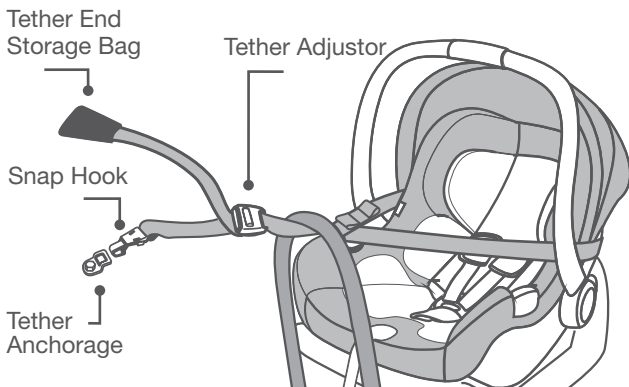

When the restraint is in a vehicle always fit the tether into the guide at the back.

## How to use the Tether Strap

1. Connect the snap hook securely to the anchorage fitting.

Note: there are several different looking types of anchorage, yours may not look like this.

Check the vehicle owners manual.

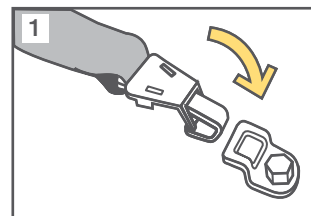

**DO NOT** attach the hook to a parcel tie down point.

2. To increase webbing tension pull upper strap through adjustor.

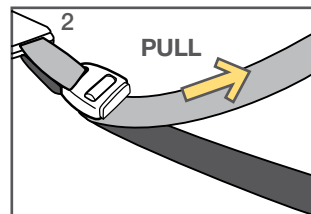

3. To release webbing tension press adjustor button and pull lower strap.

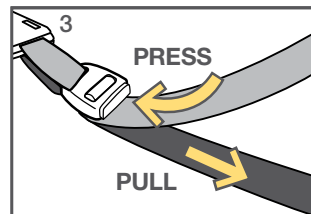

# How to use the Tether Strap

4. Do not adjust so tight that it lifts the child restraint off the vehicle seat.



5. Store unused web in bag on end of tether.

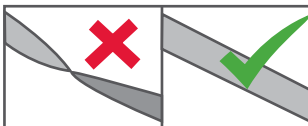
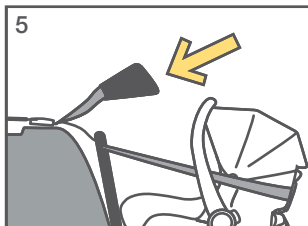

Straps must not be twisted

# Checklist — Tether Strap

1. Is snap hook securely attached to tether anchorage?

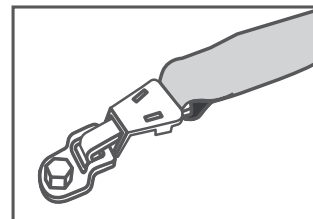

2. Is tether strap correctly tensioned?

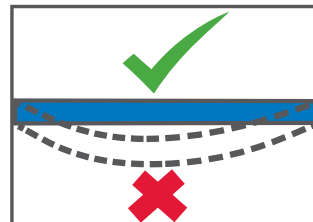

3. Is tether strap twisted?

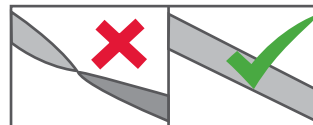

4. Is loose end of tether stored in bag?

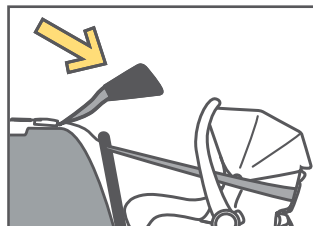

In some vehicles without a fixed parcel shelf an extension tether strap may be required. These are available in several different lengths and can be obtained from child restraint retail outlets.

## Installation – Tether Anchorage

Most cars have several threaded holes to fit the tether anchorage to.

Refer to the vehicle owners handbook for information on the location of these points.

Using the bolt provided to attach the anchor fitting to the mounting point behind where the child restraint is to be installed.

See more detailed information on the next page.

The anchor fitting must be aligned as shown unless stated otherwise in the vehicle owners handbook.

If drilling a new hole, select a position on the centre line of the seating position, and no closer than 100 mm from the front edge of the parcel shelf.

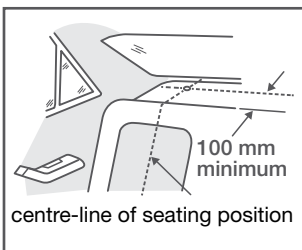
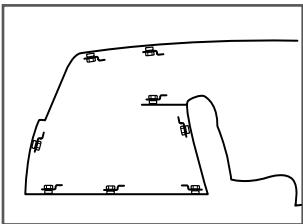
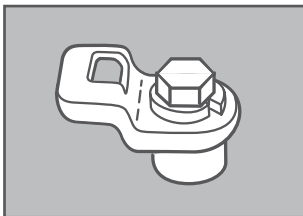

## Installation – Tether Anchorage

If the car is fitted with a child restraint anchorage point:

Locate the anchorage point behind the rear seating position (consult the vehicle owners handbook for location of the anchorage point). Remove the thread plug from the parcel shelf/floor/roof and install the attachment bolt as shown opposite.

CAUTION:  
DO NOT OVERTIGHTEN THE ATTACHMENT BOLT.  
MAXIMUM TORQUE 20Nm.

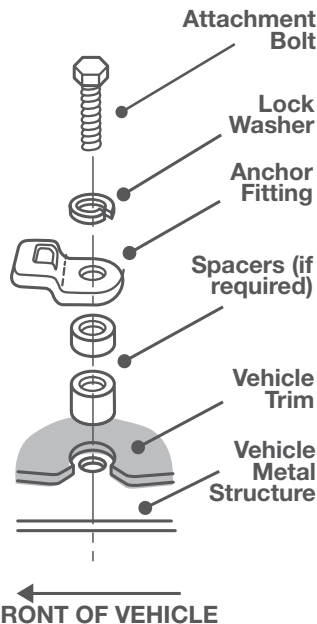

### **! WARNING**

CHILD RESTRAINTS MUST NOT BE ATTACHED TO UNSOUND METAL OR WOOD OR SYNTHETIC STRUCTURES. WHEN DRILLING THE 9 MM HOLE DO NOT DRILL THROUGH FUEL LINES, FUEL TANKS, ELECTRICAL WIRING, OR RADIO SPEAKERS. WEBBING STRAPS MUST BE PROTECTED FROM SHARP CORNERS AND EDGES.

THE ANCHOR FITTING MUST BE USED ONLY AS DESCRIBED ABOVE. IT MUST NOT BE HOOKED ONTO ANY OTHER OBJECT.

## Installation – Tether Anchorage

If the car is not fitted with a child restraint anchorage point:

For sedans only - drill a 9 mm hole in the parcel shelf on the centre line of the seating position as shown on page 22.

Install the anchor bolt as shown opposite.

It is recommended that this installation be carried out by a child restraint fitting station or licenced motor mechanic.

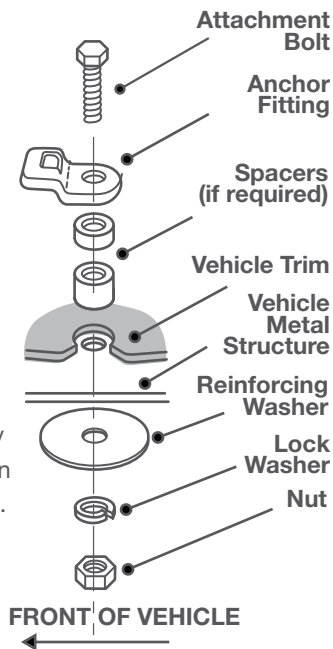

For vehicles other than sedans - In Australia, consult your nearest child restraint fitting station or traffic authority for vehicle inspection to find the best, correct position for the placement of the anchorage point, and for the correct attachment bolt length and use of spacers.

In New Zealand, consult the agent for the vehicle.

## Use with Strollers

This Joie™ child restraint can attach to Joie strollers using adapters. Instructions are included with the adapters, which are sold separately.

# Cleaning and Maintenance

## Seat Cover

Wash with cold water and mild detergent.

Do not iron.

Do not bleach or dry clean.

Do not twist the soft goods to dry with great force. It may leave the seat cover with wrinkles.

Hang dry the seat cover in the shade.

## Plastic and Metal Parts

Use only mild detergent, water and a soft cloth to clean the car seat shell, handle and harness straps. Air dry.

Do not use undiluted detergent, or other solvents to clean - these may cause damage.

## Harness Buckle

To clean the buckle: rinse using warm water. DO NOT use any soaps, solvents or lubricants. Using anything other than water can cause the buckle to malfunction. Air dry.

When the buckle is operating correctly the tongues will push in easily and will CLICK when they latch into place.

If the buckle does not appear to be working correctly get it checked or replaced by contacting the retailer from where it was purchased.

## Harness Straps

Shoulder harness straps are not removeable.  
Clean with mild detergent, water and a soft cloth only.

## Storage

Remove the child restraint from the vehicle seat if not in use for a long period of time. Put the child restraint in a cool, dry place and somewhere your child cannot access it.

# Cleaning and Maintenance

## Seat Cover

Wash with cold water and mild detergent.

Do not iron.

Do not bleach or dry clean.

Do not twist the soft goods to dry with great force. It may

leave the seat cover with wrinkles.

Hang dry the seat cover in the shade.

## Plastic and Metal Parts

Use only mild detergent, water and a soft cloth to clean the car seat shell, handle and harness straps. Air dry.

Do not use undiluted detergent, or other solvents to clean - these may cause damage.

## Harness Buckle

To clean the buckle: rinse using warm water. DO NOT use

any soaps, solvents or lubricants. Using anything other than water can cause the buckle to malfunction. Air dry.

When the buckle is operating correctly the tongues will push in easily and will CLICK when they latch into place.

If the buckle does not appear to be working correctly get it checked or replaced by contacting the retailer from where it

was purchased.

## Harness Straps

Shoulder harness straps are not removeable.

Clean with mild detergent, water and a soft cloth only.

## Storage

Remove the child restraint from the vehicle seat if not in use for a long period of time. Put the child restraint in a cool, dry place and somewhere your child cannot access it.

## The Next Restraint

This restraint is suitable for a baby up to approximately 6 months of age.

When the baby's shoulders are level with the shoulder height marker (see page 7) they should move to a bigger restraint.

The next category of restraint is forward facing and has a six point harness and will be suitable for the child until they are approximately 4 years of age.

### IMPORTANT

If the baby's neck muscles are unable to support their head, they should remain rear facing.

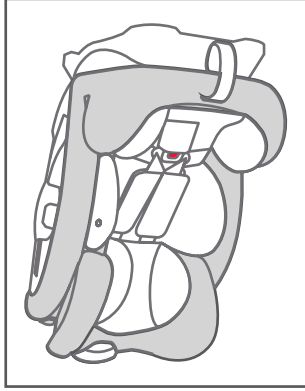

## Use with Strollers

This child restraint can attach to Joie strollers using adapters. Instructions are included with the adapters, which are sold separately.

## Extra Padding

Shoulder pads and crotch strap pad are removable and are not necessary for safety.

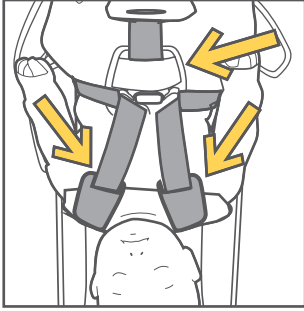

## Accessories

DO NOT add accessories, toys, padding or other items to the child restraint unless provided by Jole.

Aftermarket accessories (i.e. items not provided in the box with the child restraint), may not have been tested for use with this child restraint and if used, may lower the level of protection offered possibly leading to injury or death.

Any aftermarket accessory used should be compliant with AS/NZS 8005 (Accessories for child restraints for use in motor vehicles) and stated as suitable for use with this child restraint.

## Carry Handle Use

The carry handle can be adjusted to 3 positions.

1 To adjust the handle position, squeeze handle buttons on both sides and rotate.

2 Rotate handle until it clicks into any of the 3 positions.

The carry handle can be used in a vehicle in any locked position.

**IMPORTANT**  
Be sure handle is locked in the carry position before lifting the restraint.

An unlocked handle could allow the restraint to move unexpectedly, causing injury to the child.

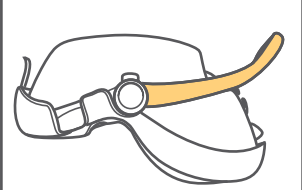
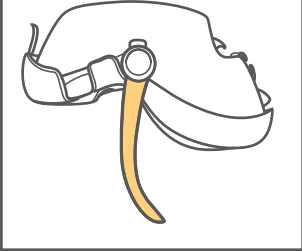
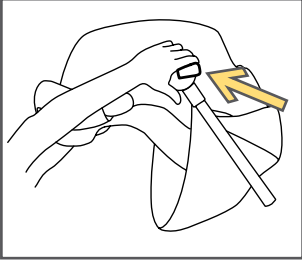

# Seat Cover Removal

1 Pull the plastic fastening pieces out from underneath the edge of the seat.

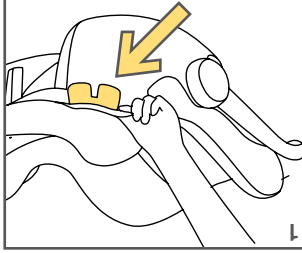

2 Pull the seat cover away from the adjustment button.

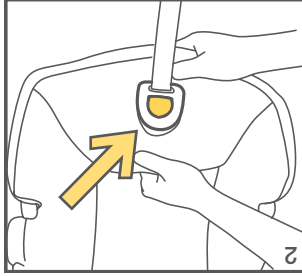

3 Remove the seat cover from the stroller release buttons.

Lift cover off seat, starting from the back.



**VERY IMPORTANT:** Only replace the cover with a Joie supplied replacement cover or a replacement cover meeting AS/NZS 8005.

# Infant Liner

The infant liner can be used to provide a snug fit for smaller babies.

In the back of the liner is an extra foam pad intended for use with low birth weight or very small babies.

This pad always faces to the back.  
Remove it when the baby is bigger.

Do not use the infant liner once the baby is bigger and the liner is restricting movement.

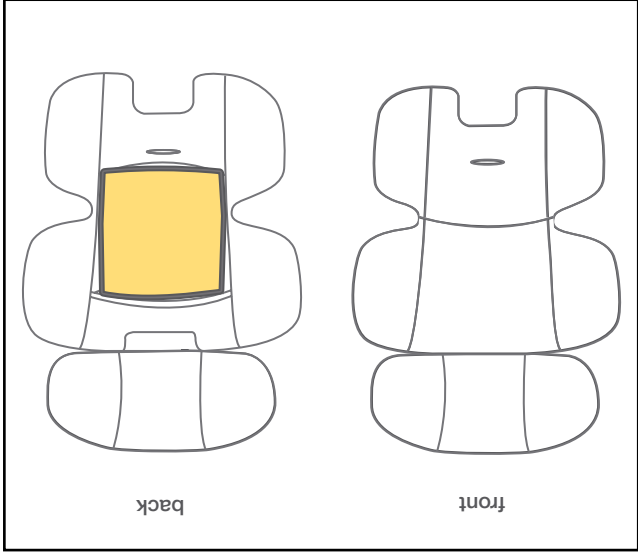
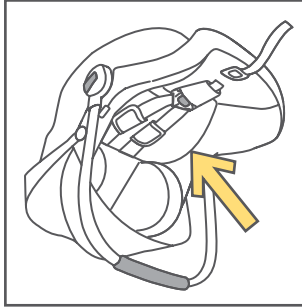



- Are buckle tongues securely fastened in buckle housing?

- Strap tension: put finger under strap and pull out.

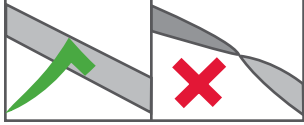
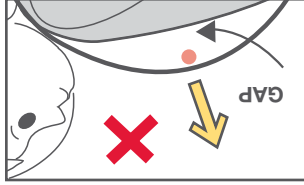
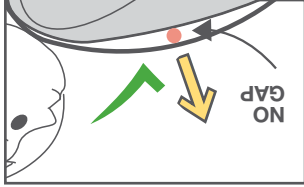
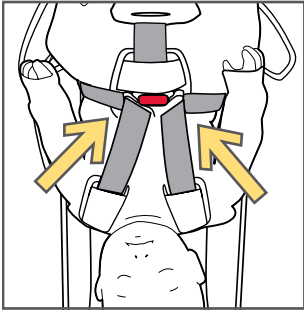

- Shoulder Straps must not be twisted.

## Canopy Removal

To remove the canopy, release the press studs, and press the buttons in the canopy mounts. Then pull the canopy bow out. To replace simply plug the canopy bows in until they click. Then fasten the press studs.

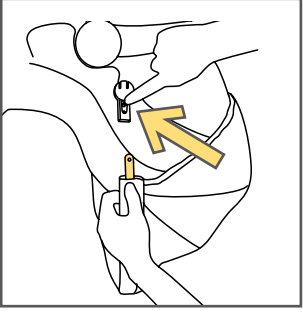

### IMPORTANT

Child must be dressed in clothing that allows the harness to firmly secure them.

### Blankets

Never use blankets or clothing that interfere with the harness. A poorly secured child can come out of the restraint during a crash. Only place blankets over child AFTER harness has been properly tightened.

### Swaddling

Infants need to be securely held by the harness. An infant wrapped in a blanket or swaddled will not be securely held and may be ejected and killed in an accident. Do not bind or wrap the infants arms or legs together.

# Securing Child in the Restraint

First check shoulder strap height and adjust if necessary. See pages 8 & 9.

1 Loosen harness by pressing on adjuster button while pulling on the harness straps.

2 Press button to open the quick release buckle (A).

Spread harness straps apart (B).

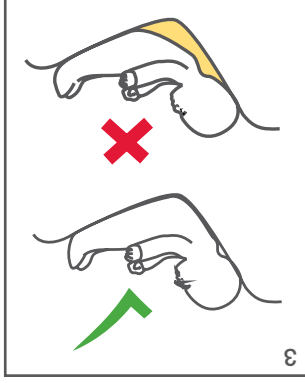
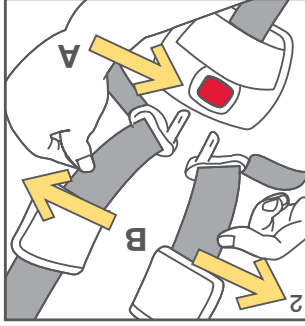
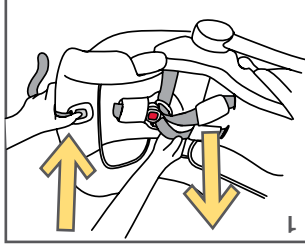

3 Place child in restraint in seated position. Child's back must be firmly against both the back and bottom of the restraint.

4 Place buckle tongues into the quick release buckle. IMPORTANT: Both buckle tongues should "CLICK" into place.

If they do not click, try again or try cleaning the buckle. See page 21.

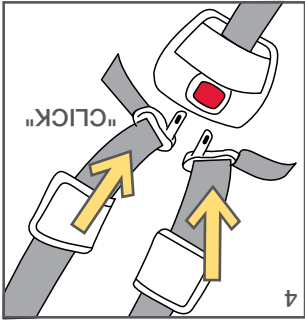

5 Tighten harness by pulling on the adjuster strap at the front of the restraint (B).

Note: you may need to pull excess shoulder strap upward through the Quick Release Buckle Tongues toward the child's shoulder (A) and then pull on the adjuster strap (B).

This may need to be repeated several times to get the webbing fitting snugly.

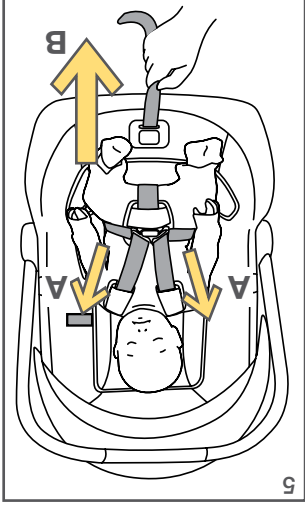

**DO NOT LEAVE CHILDREN UNATTENDED IN THE CAR**

**WARNING**

Shoulder Straps at correct height.

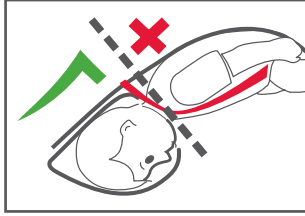

Shoulder Straps level.

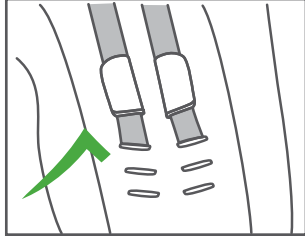

Shoulder Straps must not be twisted.

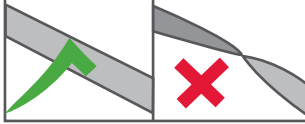

Shoulder Straps securely attached to the splitter plate.

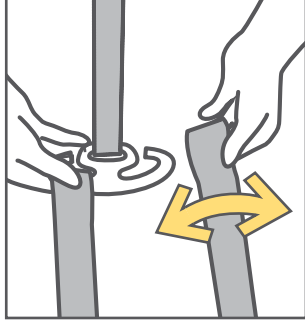

## Crotch Strap Position

There are two positions available for the crotch strap.  
The rear position is recommended for normal use and the front position for a bigger child.

### TO ADJUST:

With child removed, turn steel buckle outwards and reposition as required.

**IMPORTANT:** After changing the strap position pull firmly upward on the crotch strap to check the buckle is securely fitted.

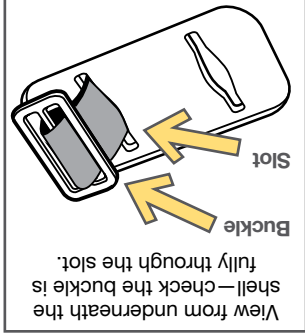
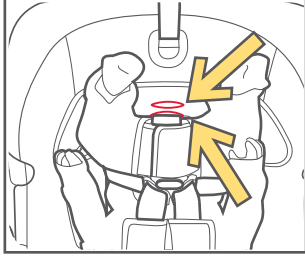

View from underneath the shell—check the buckle is fully through the slot.

# Correct Shoulder Strap Height

Correct positioning of the shoulder straps is essential for your baby's safety.

**Requirement:**  
The shoulder straps must be in the slots that are nearest to the child's shoulders, but not lower than the child's shoulders.

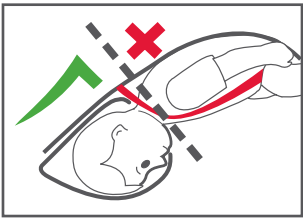

## TO CHECK:

1 With child placed in the restraint, note where the shoulder straps enter the slots in the backrest.

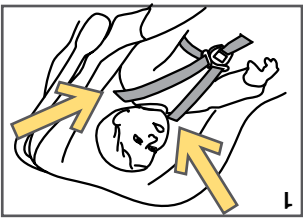

If adjustment is needed follow the next steps.

## Splitter Plate

The shoulder straps are connected to the adjuster strap with a steel plate. Remove the shoulder straps from this plate to change their height. When connected the straps must be securely in the slots in the steel plate at all times.

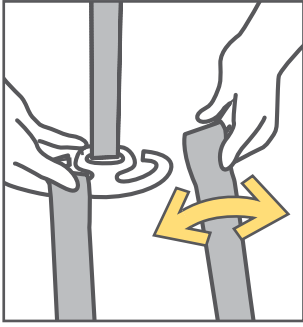

## TO ADJUST:

2 With child removed, loosen harness. Turn restraint over and remove one shoulder strap harness loop from the metal splitter plate.

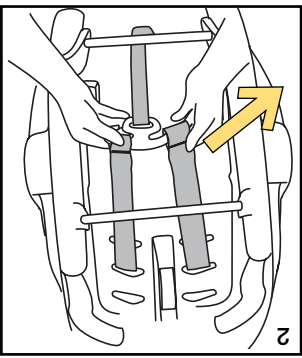

3 Pull loose end of harness loop out through slot and replace in new slot.

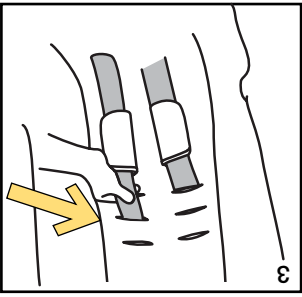

4 Re-attach shoulder strap to splitter plate.

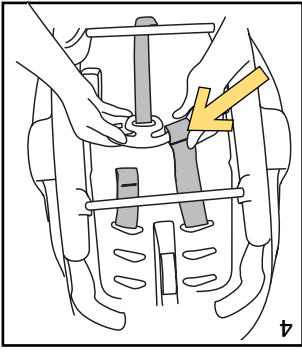

5 Repeat with the other shoulder strap.

Check the straps are at the same height.

**IMPORTANT:** Always adjust the height of the shoulder straps as the child grows

## Features

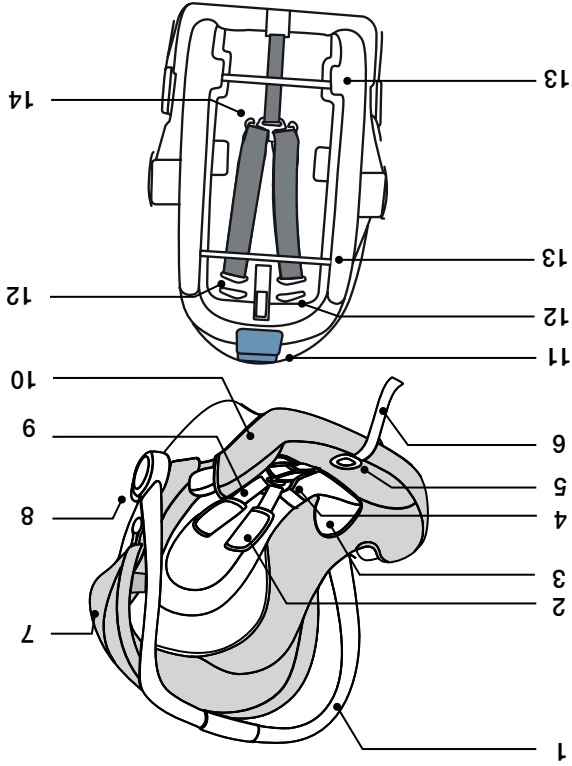

- 1 Carry Handle
- 2 Shoulder Pads
- 3 Infant Insert
- 4 Buckle and Crotch Belt
- 5 Harness Adjuster Button
- 6 Harness Adjuster Strap
- 7 Canopy
- 8 Carry Handle Lock
- 9 Harness Straps
- 10 Seat Cover
- 11 Stroller Release Handle
- 12 Shoulder Strap Slots
- 13 Base Attachment Bars
- 14 Splitter Plate

## Correct Child Size

This restraint has a shoulder height level label. Use this to know when your child is too big for the restraint.



When your child's shoulders reach the dotted line change to a bigger restraint. See page 20.

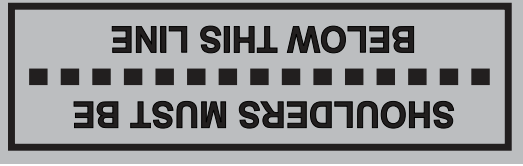
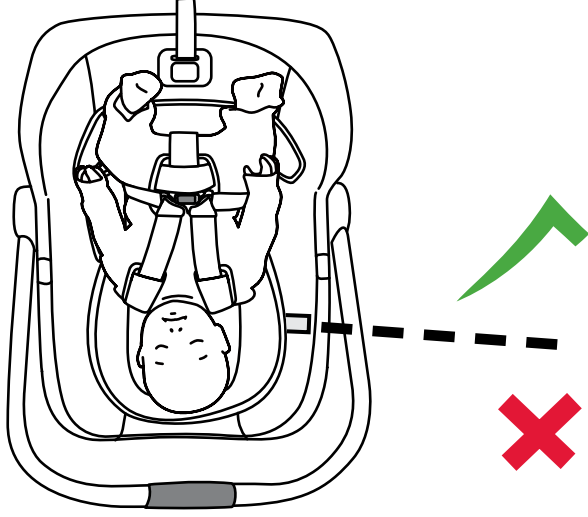

## ADDITIONAL WARNINGS

This Child Restraint is:  
To be used only in a rearward-facing position until the infant's shoulders reach the shoulder height marker (approximately 6 months of age).

Continue to use this infant restraint until the child reaches this limit.

Infants are at risk of serious injury if they face forward too early.

Ensure that children have adequate ventilation and shade when in the vehicle.

Aftermarket accessories (i.e. items not provided in the box with the child restraint), may not have been tested for use with this child restraint and if used, may lower the level of protection offered possibly leading to injury or death.

Any aftermarket accessory used should be compliant with AS/NZS 8005 (Accessories for child restraints for use in motor vehicles) and stated as suitable for use with this

child restraint.

Always check child restraint to base connection.

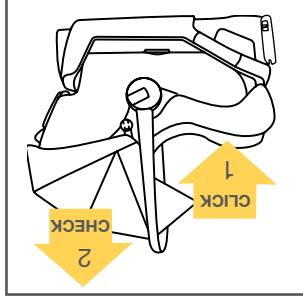

## ADDITIONAL WARNINGS

When baby is in the restraint, ALWAYS secure the harness and adjust to a firm fit.

Always check buckle and other parts for hot surfaces. A child restraint left uncovered in the sun could burn a child. Cover with blanket if leaving in car.

**Fall hazard:** Child's movement can slide carrier. NEVER place child restraint near edges of countertops, tables or other high surfaces. Always stay within arms reach whenever child restraint is not on floor/ground.

**Suffocation hazard:** child restraint can roll over on soft surfaces and suffocate child. Never place child restraint on beds, sofas, or other soft surfaces.

**Strangulation hazard:** Child can strangle in loose child restraint straps. Always use harness. Never leave child in the child restraint when straps are loose or undone.

Never place the child restraint on top of a shopping cart. The child restraint will not be properly secured and could fall.

Do not use the child restraint if it is damaged or broken.

Only use with Joie strollers or appropriate Joie adapters designed for use with other strollers.

## Quick Reference

**IMPORTANT:** After reading this Quick Reference read the following instructions carefully.

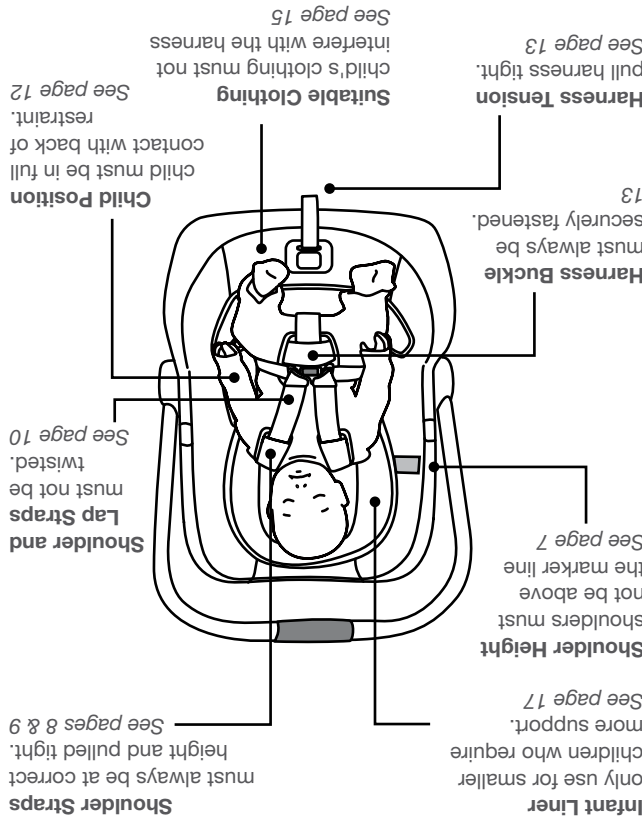

This Child Restraint is suitable for children up to approximately 6 months of age. See page 4 for more detailed information.

## ⚠️ WARNINGS

- Use the restraint exactly as shown in the instructions.
- Supervision of children is needed because they may be able to undo buckles.
- To ensure that baby's back is evenly supported, do not put more than one nappy on the baby and make sure the nappy is not folded thickly at the back.
- Fit the harness firmly to the child.
- A loose harness or restraint is dangerous.
- Do not harness an infant wrapped in a blanket or swaddled. Any blanket or wrap must only be placed over the harness and infant.
- Do not allow the restraint to come into contact with poles, hes, oils, bleach and other chemicals.
- Only use this restraint with the base it was supplied with. If a second or replacement base is required it must be a matching model number.
- DO NOT USE THIS RESTRAINT WITHOUT THE COVER.
- DO NOT USE A REAR FACING CHILD RESTRAINT WHERE AN AIRBAG IS FITTED IN FRONT OF THE SEATING POSITION.

## ⚠️ DO NOT LEAVE CHILDREN UNATTENDED IN THE CAR

NOTE: The warnings on these pages are those required by the Australian and New Zealand Standard AS/NZS 1754 for this type of child restraint. Other warnings specific to this particular child restraint will be found throughout these instructions.

This Child Restraint is suitable for children up to approximately 6 months of age.

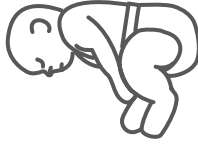

Before installation and use of this child restraint check that it is suitable for the size of your child. See pages 7 & 8 for more information.

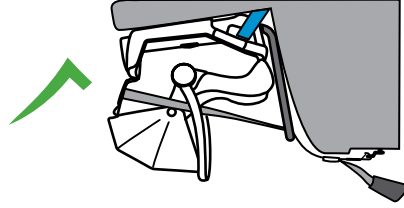

**This is a rear facing child restraint. Do not face forward.**

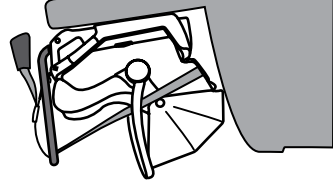

Distributed by Nuna Baby Australia Pty. Ltd.

ACN: 642 240 140

Unit 1, 35 Lyn Parade Prestons, NSW Australia 2170

For after-sales & warranty service, contact:

1800 951 070 customer@nunababy.com.au

Keep these instructions for future reference.

# Contents

2	Quick Reference
3	<b>WARNINGS</b>
4 & 5	<b>Additional Warnings</b>
6	Restraint Features
7	Correct Child Size
8 & 9	Correct Shoulder Strap Height
10	<b>Checklist</b>
11	Crotch Strap Position
12 & 13	Securing Child in the Restraint
14	<b>Checklist</b>
15	Canopy Removal
16	Seat Cover Removal
17	Infant Liner
18	Extra Padding & Accessories
19	Carry Handle Use
20	The Next Restraint
21	Use with Strollers
22	Cleaning and Maintenance

**DO NOT USE THIS CHILD RESTRAINT UNTIL YOU HAVE READ AND UNDERSTOOD THE INSTRUCTIONS IN THIS USER GUIDE AND IN YOUR VEHICLE OWNERS MANUAL**



IMPORTANT: KEEP THIS INSTRUCTION BOOKLET IN THE PLACE PROVIDED ON THE CHILD RESTRAINT

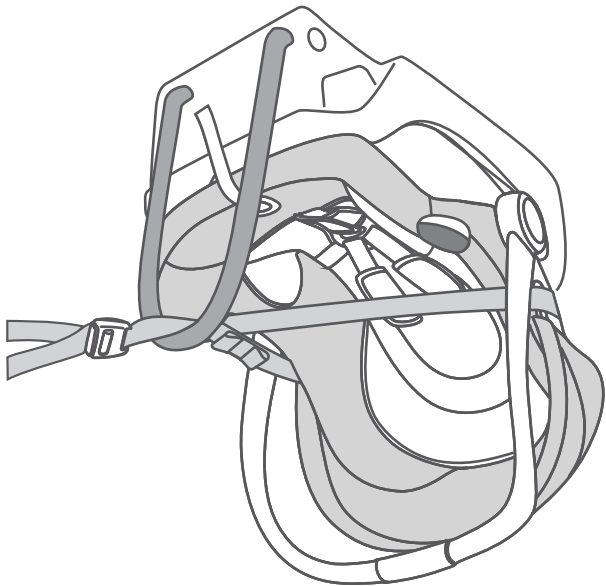

MODEL I 0911 F

gemm™

jole™

USE  
INSTRUCTIONS