

ENGLISH

**iCare** HOME2



# Instruction Manual

**icare**

Rx Only (U.S.)

The information in this document is subject to change without prior notice. Should a conflict situation arise concerning a translated document, the English language version shall prevail.



Copyright © 2022 Icare Finland Oy. All rights reserved. iCare is a registered trademark of Icare Finland Oy, all other trademarks are the property of their respective owners. Made in Finland.

Android is a registered trademark or trademark of Google Inc. Google Play is a trademark of Google LLC. App Store is a trademark of Apple Inc.

The Bluetooth® word mark and logos are registered trademarks owned by Bluetooth SIG, Inc. and any use of such marks by Icare Finland Oy is under license. Other trademarks and trade names are those of their respective owners.



**Icare Finland Oy**

Äyritie 22, FI-01510 Vantaa, Finland

Tel. +358 9 8775 1150

[www.icare-world.com](http://www.icare-world.com), [info@icare-world.com](mailto:info@icare-world.com)

# Contents

1	Safety information .....	5
1.1	For healthcare professionals .....	5
1.2	For patients and healthcare professionals.....	5
2	Intended use .....	8
3	Clinical benefits .....	8
4	Essential performance.....	8
5	Restrictions of use.....	9
5.1	Contraindications .....	9
5.2	Environmental restrictions.....	9
6	Introduction .....	10
6.1	Information on intraocular pressure.....	11
6.2	Support materials .....	11
6.3	Sales package contents.....	12
6.4	Buttons and parts .....	13
7	Get started .....	14
7.1	Insert the batteries .....	14
8	Take a measurement.....	15
8.1	Insert the probe.....	15
8.2	Switch on the tonometer .....	17
8.3	Find the correct measurement position.....	17
8.4	Adjust the supports and position the tonometer .....	18
8.5	Measure your eye pressure .....	20
8.6	Measure your eye pressure in the supine position.....	22
8.7	Errors during the measurement .....	23
8.8	Check the measurement quality .....	24
8.9	View information on your previous measurements.....	24
9	Switch off the tonometer and dispose of the probe.....	25
10	Tonometer modes.....	25
10.1	Practice mode.....	25
10.2	Rental mode .....	26
11	Tonometer settings.....	26
11.1	Language settings .....	27
11.2	Time settings.....	27
11.3	Date settings .....	27
11.4	Volume settings .....	27
11.5	Probe base light settings.....	28
11.6	Display brightness settings .....	28
11.7	Tonometer's serial number and firmware version .....	28
12	iCare software system .....	28
12.1	Compliance standards.....	29
12.2	Install the software.....	29

12.3	Transfer measurement data to iCare CLINIC or iCare CLOUD ..	30
12.4	Bluetooth notifications and errors .....	31
13	Troubleshooting.....	32
14	Maintenance.....	33
14.1	Replace the probe base.....	33
14.2	Clean and disinfect the tonometer.....	34
14.3	Lifetime .....	35
14.4	Return the tonometer for service or repair.....	35
14.5	Recycle .....	35
15	Glossary .....	36
16	Accessories, parts, and other supplies.....	36
17	Technical information .....	37
17.1	Technical description .....	37
17.2	System requirements for iCare CLINIC .....	37
17.3	IT network specifications .....	38
17.4	Intended information flow .....	38
17.5	Potential hazardous situations resulting from the failure of the IT network .....	38
17.6	Required characteristics of the IT network.....	39
17.7	Performance data.....	39
17.8	Symbols and trademarks .....	40
17.9	Information for the user regarding the radio communication part of the tonometer.....	41
17.10	Bluetooth module information.....	42
17.11	Statement of compliance.....	42
17.12	Electromagnetic declaration.....	43

# 1 Safety information

## 1.1 For healthcare professionals



**WARNING!** Federal law (U.S.) restricts this device to sale by or on the order of a physician or properly licensed practitioner.



**WARNING!** Healthcare professionals must inform patients not to modify or discontinue their treatment plan without receiving instructions from the healthcare professional.



**WARNING!** When reading the measurement data in a clinic or hospital environment, make sure the tonometer and the computer or mobile device which are not medical equipment are located outside of the patient environment, i.e. 1.5 m (5 feet) from the patient.



**WARNING!** Connection of the tonometer to IT networks including other equipment could result in previously unidentified risks to patients, operators, or third parties.



**WARNING!** The responsible organization should identify, analyze, evaluate, and control any additional risks resulting from the tonometer connected to IT networks, including other equipment.



**PRECAUTION!** Certain microbiological agents (for example, bacteria) can be transmitted from the forehead or cheek support. To prevent this, clean the forehead and cheek supports with disinfectant for each new patient.



**PRECAUTION!** Changes to the IT network could introduce new risks requiring additional analysis by the responsible organization. The changes include:

- changes in the IT network configuration
- connection of additional items to the IT network
- disconnecting items from the IT network
- update or upgrade of equipment connected to the IT network

## 1.2 For patients and healthcare professionals



**WARNING!** The tonometer is intended for personal use only. Measuring other people, animals, or objects is forbidden.



**WARNING!** Do not use the tonometer in the restricted environments defined in chapter “5.2 Environmental restrictions” of this manual.



**WARNING!** Patients must not modify or discontinue their treatment plan without receiving guidance from a healthcare professional.



**WARNING!** The tonometer must not be dropped. To avoid dropping the tonometer and to ensure safe handling, always use the wrist strap to keep the tonometer attached to your wrist when in use. If the tonometer is dropped and the tonometer casing opens, press the casing to close the openings.



**WARNING!** Removing, covering, or defacing any label or sign on the tonometer voids all the responsibilities and liabilities of the manufacturer concerning the safety and effectiveness of the tonometer.



**WARNING!** Remove the batteries from the tonometer if it is not likely to be used for some time.



**WARNING!** Only probes are intended for contacting the eye. Avoid touching the eye with other parts of the tonometer. Do not push the tonometer into the eye.



**WARNING!** If you need help in using the iCare HOME2 tonometer, contact your healthcare professional.



**WARNING!** Use of eye drops right before the measurement or topical anesthesia may affect the measurement result.



**WARNING!** Do not use probes without a plastic tip. Do not use deformed probes. Contact the manufacturer or local distributor if you notice faulty probes or probe packages.

























**WARNING!** Use only original and certified probes made by the manufacturer. The probes are for single use (single pair of measurement sequences) only. Each session is defined by one successful measurement in both eyes, but in case either eye is inflamed or infected, measure the healthy eye first.



**WARNING!** Use probes taken only from an intact, original packaging. The manufacturer cannot guarantee the sterility of the probe once the seal is compromised. Re-sterilization or re-use of the probe could result in incorrect measurement values, breakdown of the probe, cross-contamination of bacteria or viruses, and infection of the eye. Re-sterilization or re-use will void all the responsibilities and liabilities of the manufacturer concerning the safety and effectiveness of the tonometer.



**WARNING!** To prevent contamination, keep unused probes in their box. Do not touch a bare probe. Do not use a probe if it touches a non-sterile surface such as a table or a floor.

-  **WARNING!** Shorten the cheek and forehead supports of the tonometer only slightly at a time to prevent the tonometer from getting too close to your eye.
-  **WARNING!** Do not connect anything to the tonometer's USB port but the USB cable supplied with the tonometer.
-  **WARNING!** Keep the USB cable out of the reach of children and pets due to the risk of strangulation.
-  **WARNING!** The tonometer's batteries are not rechargeable. Do not try to charge the tonometer with USB chargers connected to a mains voltage.
-  **WARNING!** Do not connect the USB cable to the tonometer's USB port except when uploading patient measurement data. Do not take any measurements when the USB cable is connected.
-  **WARNING!** The tonometer should only be opened by qualified iCare service personnel. The tonometer does not contain any user-serviceable parts, apart from the batteries and the probe base. The tonometer does not require any routine servicing or calibration other than changing the batteries at least annually and the probe base every six months. If there is a reason to believe that the servicing of the tonometer is necessary, contact the manufacturer or local distributor.
-  **WARNING!** The tonometer must not be repaired or re-assembled by any other than the manufacturer or its authorized service center. If the tonometer is broken, do not use it. Take it to an authorized iCare service center for repair.
-  **WARNING!** To avoid possible damage, keep the tonometer out of the reach of children and pets. The probe base, battery cover, screws, collar, and probes are small objects and may be accidentally swallowed.
-  **WARNING!** Do not change the batteries or the probe base when the USB cable is connected.
-  **WARNING!** Servicing or maintenance actions must not be performed while the tonometer is in use.
-  **WARNING!** The tonometer must be switched off when the probe base is changed.
-  **WARNING!** The probe base must be changed, not cleaned.
-  **WARNING!** Never immerse the tonometer in liquid. Do not spray, pour, or spill liquid on the tonometer, its accessories, connectors, switches, or openings in the cover. Immediately remove any liquid from the surface of the tonometer.
-  **WARNING!** Do not modify the tonometer in any way. Changes or modifications not expressly approved by the manufacturer could void the user's authority to operate the tonometer.
-  **WARNING!** Use of this equipment adjacent to or stacked with other equipment should be avoided because it could result in improper operation. If such use is necessary, this equipment and the other equipment should be observed to verify that they are operating normally.
-  **WARNING!** Use of accessories, transducers, and cables other than those specified or provided by the manufacturer of this equipment could result in increased electromagnetic emissions or decreased electromagnetic immunity of this equipment and result in improper operation.
-  **WARNING!** Interference may occur in the vicinity of equipment marked with the non-ionizing radiation symbol.
-  **WARNING!** Sources of power frequency magnetic field should be used no closer than 15 cm (6 inches) to any part of the tonometer, including the cables specified by the manufacturer, to avoid the degradation of performance.
-  **WARNING!** Portable RF communications equipment (including peripherals such as antenna cables and external antennas) should be used no closer than 30 cm (12 inches) to any part of the tonometer, including the cables specified by the manufacturer, to avoid the degradation of performance.
-  **PRECAUTION!** Read this manual carefully, as it contains important information about using and servicing the tonometer.
-  **PRECAUTION!** Use the tonometer only for measuring intraocular pressure. Any other use is improper. The manufacturer is not liable for any damage arising from improper use, or for the consequences of such use.
-  **PRECAUTION!** Do not use the tonometer near inflammable substances, including inflammable anesthetic agents.
-  **PRECAUTION!** Report any serious incidents related to the tonometer to your competent health authority and the manufacturer or the manufacturer's representative.



**PRECAUTION!** When removing the tonometer from its packaging, and each time before use, visually inspect the tonometer for any external damage, particularly for possible damage to the tonometer casing. If you suspect damage to the tonometer, contact the manufacturer or the distributor of the tonometer.



**PRECAUTION!** Use only the battery type specified in the technical specification section of this manual. Do not use rechargeable batteries, as they do not have sufficient voltage.



**PRECAUTION!** The tonometer switches off the display when it has not detected any movement for 15 seconds. The tonometer switches off automatically if it has not been used for 3 minutes.



**PRECAUTION!** Before taking measurements, update the tonometer's time to your local time manually from the tonometer's settings or automatically by connecting the tonometer to the iCare PATIENT2 application or to the iCare EXPORT software.



**PRECAUTION!** Do not cover the eye recognition transmitters or sensor during the measurement, for example with your fingers. Keep your hand, hair, and objects such as pillows away from the temple side of your eye, as they produce an infrared reflection that causes an error.



**PRECAUTION!** Eye detection is based on the difference of infrared reflections received from the transmitters: the nose side reflects more than the temple side. If the transmitters become dirty, the recognition may be interfered.



**PRECAUTION!** To ensure the correct functioning of the tonometer, change the probe base every six months.



**PRECAUTION!** Non-ME equipment (computer or mobile device) used in the system for transferring data must comply with the electromagnetic emission and immunity requirements for multimedia equipment: CISPR 32 and CISPR 35.



**PRECAUTION!** The measurement method of the tonometer is based on a magnetically induced motion of a probe and therefore an external magnetic or radiated RF electromagnetic field disturbing the probe may prevent the measurement. In such a case the tonometer continuously displays error messages during measurement and asks you to repeat the measurement. Situation can be solved either by removing the source of interference from the vicinity of the tonometer or by performing the measurement in different location with no such interference.



**PRECAUTION!** The measurement data transfer may be interrupted during electromagnetic disturbance. In such case, reconnect the tonometer to the computer or mobile device. If this does not solve the issue, perform the data transfer in other location with no such interference. The measurement data will not be deleted from the tonometer before the data is transferred successfully.



**PRECAUTION!** Portable and mobile RF communications equipment can affect the tonometer.



**PRECAUTION!** Although the tonometer's own electromagnetic emissions are well below the levels permitted by the relevant standards, they may cause interference in other nearby devices, for example sensitive sensors.

## 2 Intended use

The iCare HOME2 tonometer is a prescription device intended as an adjunct to the routine clinical monitoring of intraocular pressure (IOP) of adult patients.

## 3 Clinical benefits

With the iCare HOME2 tonometer, you can measure your eye pressure at various times during the day and night. These measurements taken outside your clinic visits may help your doctor better understand your eye pressure. High-peak and mean eye pressure as well as large eye pressure fluctuations are risk factors for glaucoma progression (1, 2). There may be eye pressure peaks and fluctuations outside of office hours and those would remain undetected without home eye pressure monitoring (3,4,5). Diurnal eye pressure data helps in treatment decisions, for example, when evaluating the success of a pressure-lowering procedure or the effect of topical medication (6,7).

This eye pressure measurement tool is an adjunct to the standard of care and does not replace the conventional methods used to diagnose and manage patients, nor should it alter the follow-up schedule otherwise indicated for a particular patient.

## 4 Essential performance

The essential performance of the iCare HOME2 tonometer is to measure intraocular pressure with specified accuracy, to display the measurement result or error conditions, and to transfer the data into the iCare software system.

If the essential performance of the tonometer is lost or degraded due to electromagnetic disturbances, the tonometer continuously displays error messages during the measurement and asks you to repeat the measurement. See chapter “17.12 Electromagnetic declaration” for instructions on proper electromagnetic environment.

---

1) Asrani et al., “Large diurnal fluctuations in intraocular pressure are an independent risk factor in patients with glaucoma.” *J. Glaucoma* 2000;9(2):134-142.

2) Cvenkel et al., “Self-monitoring of intraocular pressure using iCare HOME tonometry in clinical practice.” *Clin Ophthalmol* 13, 841-847 2019 May 10.

3) Barkana et al., “Clinical utility of Intraocular pressure monitoring outside of normal office hours in patients with glaucoma.” *Arch. Ophthalmol.* 2006;124(6):793-797.

4) Nakakura et al., “Relation between office intraocular pressure and 24-hour intraocular pressure in patients with primary open-angle glaucoma treated with a combination of topical antiglaucoma eye drops.” *J Glaucoma* 2007 Mar;16(2):201-4.

5) Hughes E et al., “24-hour monitoring of intraocular pressure in glaucoma management: A retrospective review.” *J Glaucoma* 2003;12(3):232-236.

6) Awadalla et al., “Using Icare HOME tonometry for follow-up of patients with open-angle glaucoma before and after selective laser trabeculoplasty.” *Clinical & experimental ophthalmology* vol. 48,3 (2020): 328-333.

7) Astakhov et al., “The role of self-dependent tonometry in improving diagnostics and treatment of patients with open angle glaucoma.” *Ophthalmology Journal.* 2019;12(2):41-46.



## 5 Restrictions of use



**WARNING!** The tonometer is intended for personal use only. Measuring other people, animals, or objects is forbidden.



**WARNING!** Do not use the tonometer in the restricted environments defined in chapter “5.2 Environmental restrictions” of this manual.



**PRECAUTION!** Use the tonometer only for measuring intraocular pressure. Any other use is improper. The manufacturer is not liable for any damage arising from improper use, or for the consequences of such use.



**PRECAUTION!** Do not use the tonometer near inflammable substances, including inflammable anesthetic agents.

### 5.1 Contraindications

#### **You should not use the iCare HOME2 tonometer if you:**

- have an active ocular infection (for example, pink eye or infectious conjunctivitis)
- have had a recent trauma to your eye including corneal laceration or corneal or scleral perforation
- have disabling arthritis or difficulty handling the tonometer
- have severe difficulty with opening your eyes, including abnormal contractions or twitches of the eyelid (blepharospasm)
- have involuntary, rapid, and repetitive movement of the eyes (nystagmus)

#### **You may not be eligible for use of the iCare HOME2 tonometer if you:**

- have poor uncorrected near vision of 20/200 or worse
- have only one working eye
- have poor or off-center visual fixation
- have poor hearing without an aid or communicate using sign language
- use contact lenses
- have dry eyes
- have keratoconus (a corneal disorder)
- have a congenitally (from birth) small eye (microphthalmos)
- have an enlarged eye from childhood glaucoma (buphthalmos)
- have significant glaucomatous central field loss

#### **The safety and effectiveness of the iCare HOME2 tonometer has not been evaluated for patients with:**

- high corneal astigmatism (>3d)
- history of prior invasive glaucoma surgery or corneal surgery including corneal laser surgery (for example, LASIK)
- corneal scarring
- very thick or very thin corneas (central corneal thickness greater than 600  $\mu\text{m}$  or less than 500  $\mu\text{m}$ )
- whom it is already difficult to obtain clinical intraocular measurements (for example, due to eyelid squeezing or tremor)
- cataract extraction within the last 2 months

### 5.2 Environmental restrictions

The iCare HOME2 tonometer should not be used in medical vehicles or similar environments where the vibration or noise levels are so high that the user cannot hear error signals.

See chapter “17.12 Electromagnetic declaration” for the correct electromagnetic use environment.

**NOTE!** When not in use, keep the tonometer in the carrying case to protect it from dirt and direct sunlight that might cause damage to the tonometer.

## 6 Introduction



**WARNING!** Healthcare professionals must inform patients not to modify or discontinue their treatment plan without receiving instructions from the healthcare professional.



**WARNING!** Patients must not modify or discontinue their treatment plan without receiving guidance from a healthcare professional.



**WARNING!** The tonometer is intended for personal use only and measuring other people, animals, or objects is forbidden.



**WARNING!** If you need help in using the iCare HOME2 tonometer, contact your healthcare professional.



**WARNING!** Federal law (U.S.) restricts this device to sale by or on the order of a physician or properly licensed practitioner.



**PRECAUTION!** Do not cover the eye recognition transmitters or sensor during the measurement, for example with your fingers. Keep your hand, hair, and objects such as pillows away from the temple side of your eye, as they produce an infrared reflection that causes an error.



**PRECAUTION!** Read this manual carefully, as it contains important information about using and servicing the tonometer.



**PRECAUTION!** Report any serious incidents related to the tonometer to your competent health authority and the manufacturer or the manufacturer's representative.

### The iCare software system consists of the following:

- iCare HOME2 tonometer
- iCare CLINIC, a browser-based software service with which the healthcare professional and patient can view the measurement data
- iCare CLINIC On-premises, a version of iCare CLINIC that can be installed on a hospital's or clinic's own server. With iCare CLINIC On-premises, the measurements cannot be viewed from outside of the hospital's network or clinic.
- iCare PATIENT2 mobile application with which the patient and healthcare professionals can view measurement data and transfer it to the iCare CLINIC cloud service or to iCare CLOUD
- iCare EXPORT computer software with which the patients and healthcare professionals can transfer the measurement data into the iCare CLINIC cloud service or iCare CLINIC On-premises or iCare CLOUD

See chapter "12 iCare software system" for details.

If a patient's tonometer is not registered to a healthcare professional's iCare CLINIC account, the patient can store their measurement data to a private account in the iCare CLOUD service. For information on how to set up a private account, read the Getting started guide in the tonometer's carrying case.

If the iCare CLOUD or iCare CLINIC cloud services are unavailable, the measurement results remain stored in HOME2 tonometer's memory. The measurement results can be transferred when the cloud service becomes available again. iCare HOME2 tonometer can also be used on its own without the iCare CLOUD and iCare CLINIC cloud services.

With the iCare HOME2 tonometer, you can measure your eye pressure. During the measurement, the tonometer's probe gently touches your eye six times. After the six successful measurements, the tonometer calculates your eye pressure and stores it in the tonometer's memory. The device history shows the 100 most recent measurement results.

If your healthcare professional instructed you to measure both eyes, you can

use the same probe for both. After you have taken the measurements, place the probe back in its container and dispose of it in a mixed waste bin. Use a new, unused probe when you take a measurement the next time.

You can measure your eye pressure when you are sitting, standing, or lying down (supine position). The tonometer includes infrared eye recognition sensors to identify which eye, right or left, you are measuring.

After the measurement, you can transfer the measurement data to iCare CLINIC or iCare CLOUD using your computer or mobile device.

Familiarize yourself thoroughly with the tonometer, software, and the operational procedures before use.

## 6.1 Information on intraocular pressure

The normal eye pressure ranges from 10 to 20 mmHg (1). The risk for glaucoma increases if the eye pressure is above this range. In normal tension glaucoma, the optic nerve is damaged even though the eye pressure is not very high. The optimal target pressure in glaucoma and ocular hypertension needs to be defined case by case. Ask your healthcare professional for your target eye pressures. Agree when you need to contact your healthcare professional about your eye pressure measurement results.

Follow your healthcare professional's instructions on the frequency of measurements. Unless otherwise instructed, the recommended frequency of measurements is 3-6 times a day. Keep a record of your eye pressure for your healthcare professional. A single measurement does not provide accurate information on your eye pressure level. You need to take and record several measurements over time. Try to measure your eye pressure at the same times each day for consistency.

An elevated eye pressure as well as fluctuations in the eye pressure are underlying risk factors for glaucoma (2,3). When you measure your eye pressure in a variety of situations and at different times of the day, you and your healthcare professional get a comprehensive view of the changes in your eye pressure and the effectiveness of your medication.

## 6.2 Support materials

To learn to use the tonometer, read this manual carefully. The USB stick provided in the tonometer's sales package contains a quick guide, this instruction manual, and a training video to help you get started with the tonometer. If you have problems using the tonometer, contact the organization from which you obtained the tonometer or Icare USA.

You can find contact information for Icare USA at <https://www.icare-world.com/us/>.

---

1) Dan T. Gudgel, "Eye Pressure." American Academy of Ophthalmology, 2018 [<https://www.aaopt.org/eye-health/anatomy/eye-pressure>]

2) Asrani et al., "Large diurnal fluctuations in intraocular pressure are an independent risk factor in patients with glaucoma." J. Glaucoma 2000;9(2):134-142.

3) Cvenkel et al., "Self-monitoring of intraocular pressure using iCare HOME tonometry in clinical practice." Clin Ophthalmol 13, 841-847 2019 May 10.

### 6.3 Sales package contents

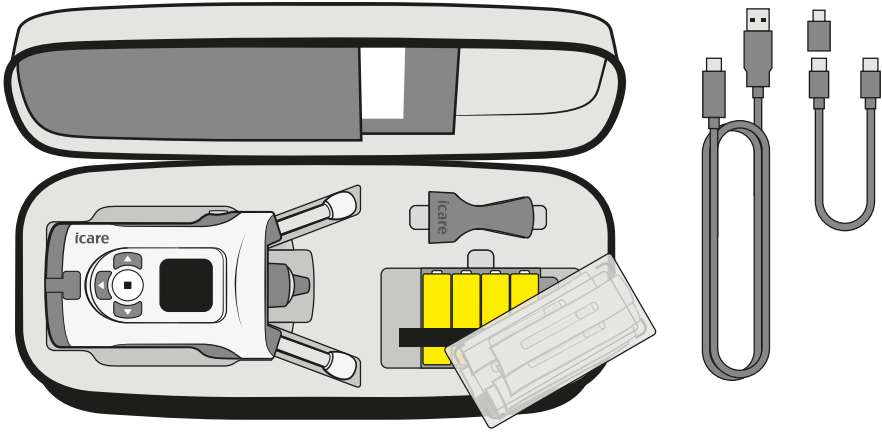

The iCare HOME2 sales package contains:

- iCare HOME2 tonometer
- Carrying case
- Instruction Manuals
- Probe applicator
- Quick Guides
- Screwdriver Torx TX8
- Spare probe base
- Sterilized single-use probes
- USB-C to Micro-USB B adapter
- USB cable for PC connection (USB-C to USB-A)
- USB cable for mobile device connection (USB-C to USB-C)
- USB stick with instruction materials
- Warranty card
- Wrist strap
- 4 x AA 1.5 V Alkaline batteries

## 6.4 Buttons and parts



**WARNING!** Removing, covering, or defacing any label or sign on the tonometer voids all the responsibilities and liabilities of the manufacturer concerning the safety and effectiveness of the tonometer.

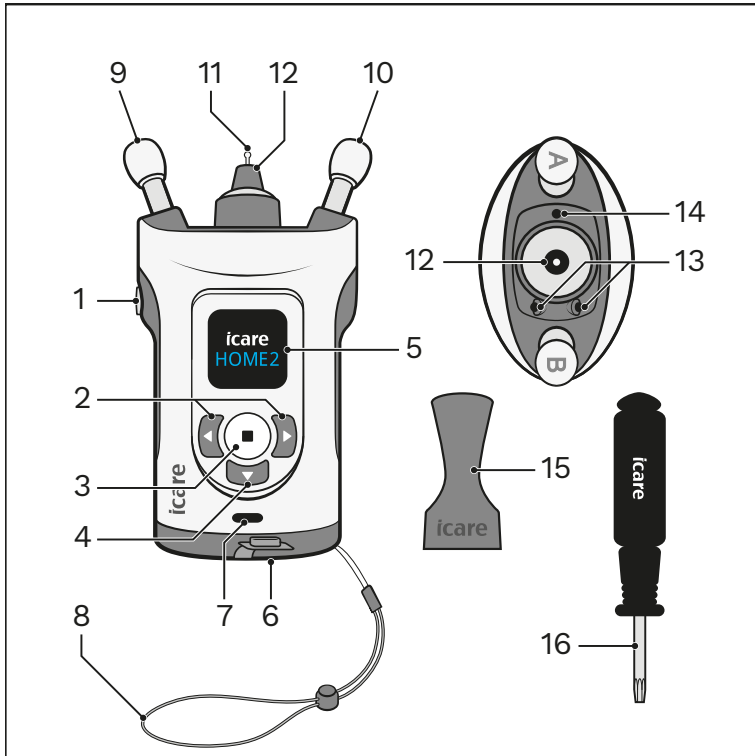

- |                             |                               |
|-----------------------------|-------------------------------|
| 1. Measure button           | 11. Probe                     |
| 2. Navigation buttons       | 12. Probe base                |
| 3. Select button            | 13. Infrared LED transmitters |
| 4. Return button            | 14. Infrared LED sensor       |
| 5. Display                  | 15. Probe applicator          |
| 6. Battery cover            | 16. Screwdriver               |
| 7. USB-C port and USB cover |                               |
| 8. Wrist strap              |                               |
| 9. Forehead support         |                               |
| 10. Cheek support           |                               |

## 7 Get started



**WARNING!** The tonometer must not be dropped. To avoid dropping the tonometer and to ensure safe handling, always use the wrist strap to keep the tonometer attached to your wrist when in use. If the tonometer is dropped and the tonometer casing opens, press the casing to close the openings.



**PRECAUTION!** When removing the tonometer from its packaging, and each time before use, visually inspect the tonometer for any external damage, particularly for possible damage to the tonometer casing. If you suspect damage to the tonometer, contact the manufacturer or the distributor of the tonometer.

### 7.1 Insert the batteries



**WARNING!** Remove the batteries from the tonometer if it is not likely to be used for some time.



**PRECAUTION!** Use only the battery type specified in the technical specification section of this manual. Do not use rechargeable batteries, as they do not have sufficient voltage.

**NOTE!** The quality of the batteries affects the number of measurements that can be taken with a single set of batteries.

**NOTE!** Replace all batteries with new ones at the same time.

#### 1. Use the screwdriver to open the battery cover and open it up.

The batteries are in the tonometer carrying case under the box of probes.

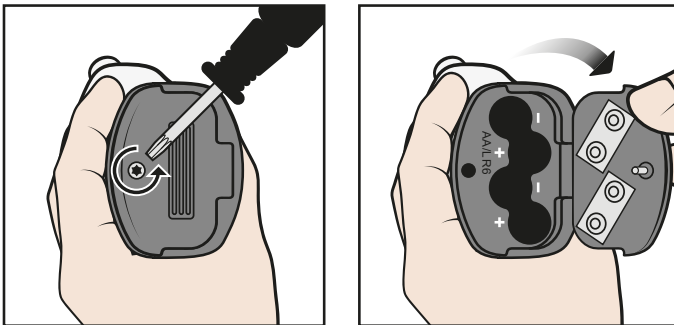
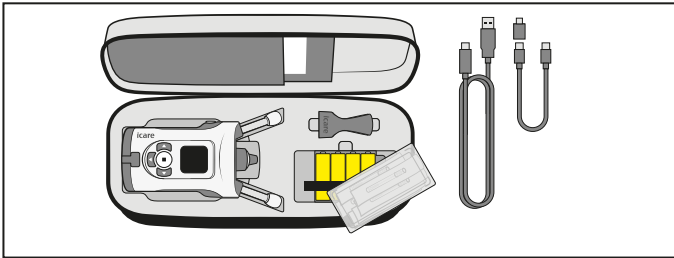

#### 2. Insert the batteries according to the markings inside the battery compartment.

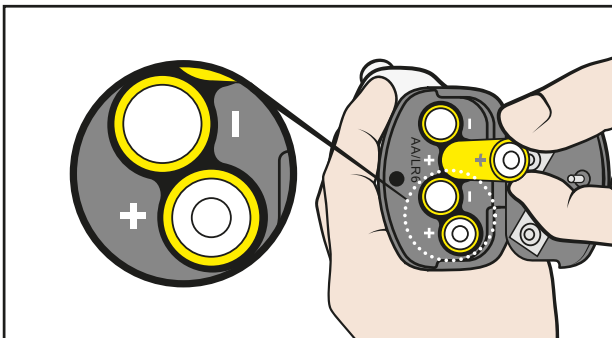

### 3. Close the battery cover and lock the cover with the screwdriver.

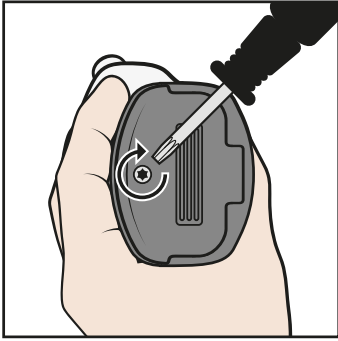

**NOTE!** The battery charge level is shown when you switch the tonometer on:



## 8 Take a measurement



**WARNING!** Only probes are intended for contacting the eye. Avoid touching the eye with other parts of the tonometer. Do not push the tonometer into the eye.



**WARNING!** Use of eye drops right before the measurement or topical anesthesia may affect the measurement result.



**PRECAUTION!** Before taking measurements, update the tonometer's time to your local time manually from the tonometer's settings or automatically by connecting the tonometer to the iCare PATIENT2 application or to the iCare EXPORT software.

To ensure a reliable measurement result:

- Take the measurement in a quiet place
- Remain still and avoid talking and looking around during the measurement

If you feel unsure about taking the measurement, practice the measurement in the practice mode of the tonometer. See chapter “10.1 Practice mode”.

### 8.1 Insert the probe



**WARNING!** Do not use probes without a plastic tip. Do not use deformed probes. Contact the manufacturer or local distributor if you notice faulty probes or probe packages.



**WARNING!** Use only original and certified probes made by the manufacturer. The probes are for single use (single pair of measurement sequences) only. Each session is defined by one successful measurement in both eyes, but in case either eye is inflamed or infected, measure the healthy eye first.



**WARNING!** Use probes taken only from an intact, original packaging. The manufacturer cannot guarantee the sterility of the probe once the seal is compromised. Re-sterilization or re-use of the probe could result in incorrect measurement values, breakdown of the probe, cross-contamination of bacteria or viruses, and infection of the eye. Re-sterilization or re-use will void all the responsibilities and liabilities of the manufacturer concerning the safety and effectiveness of the tonometer.



**WARNING!** To prevent contamination, keep unused probes in their box. Do not touch a bare probe. Do not use a probe if it touches a non-sterile surface such as a table or a floor.

#### 1. Do not use a probe if it has touched your hand, a table, or other non-sterile surface.

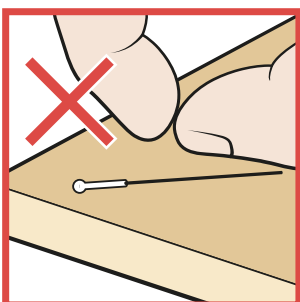

2. Place the probe applicator over the probe base.

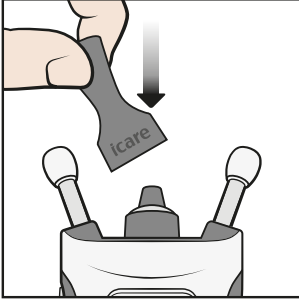

3. Open the packaging.

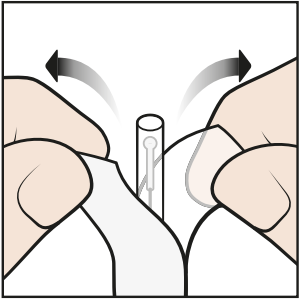

4. Remove the cap.

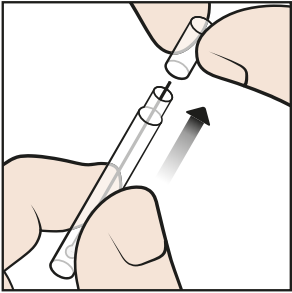

5. Drop the probe from the container to the probe applicator.

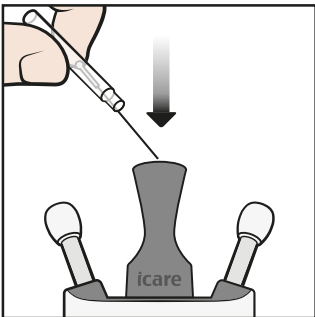

6. Remove the probe applicator.

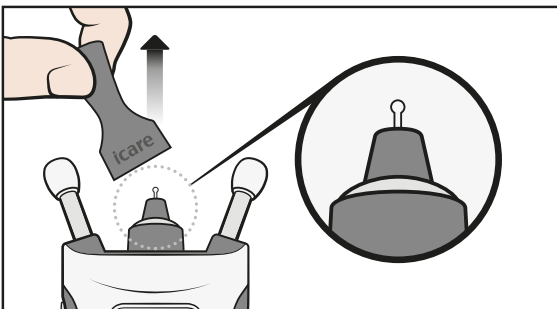



## 8.2 Switch on the tonometer



**PRECAUTION!** The tonometer switches off the display when it has not detected any movement for 15 seconds. The tonometer switches off automatically if it has not been used for 3 minutes.

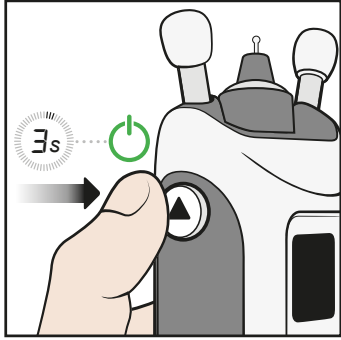

Make sure that the date and time shown on the display are correct. If they are incorrect, update them from the tonometer's settings or by connecting the tonometer to the iCare PATIENT2 application or to the iCare EXPORT software.

Press down  until you hear a beep. The text “Start” is shown on the display.

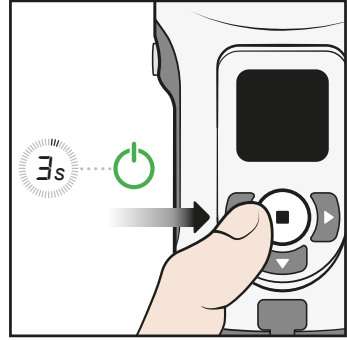

OR



**Alternatively,** press down  until you hear a beep. Then press  again to enter the measurement mode. The text “Start” is shown on the display.

## 8.3 Find the correct measurement position

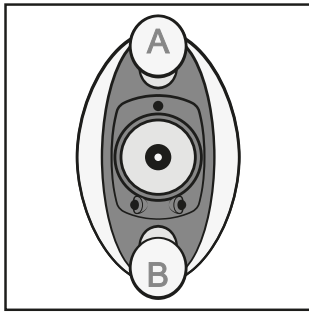

The forehead support A rests on your forehead and the cheek support B rests on your cheek.

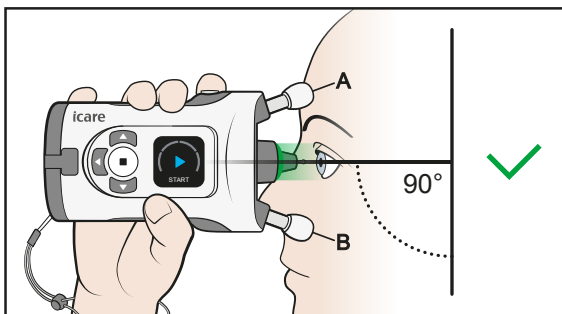



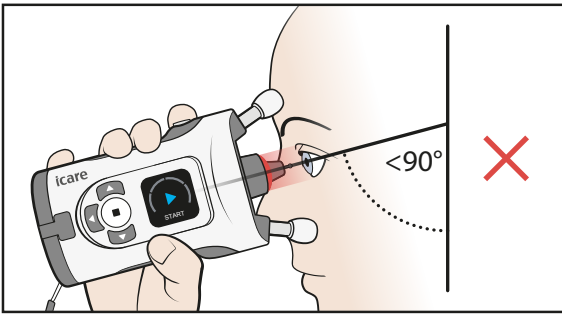

Look straight ahead and the tonometer is at a 90-degree angle to your face. The probe is about 5 mm (3/16 inches) from your eye and points perpendicularly to the center of your eye.

**NOTE:** The tonometer measuring button should point upwards.



If you see a red light in the probe base, the tonometer is tilted too much downwards. You should straighten your posture and lift your chin.

### 8.4 Adjust the supports and position the tonometer

-  **WARNING!** Only probes are intended for contacting the eye. Avoid touching the eye with other parts of the tonometer. Do not push the tonometer into the eye.
-  **WARNING!** Shorten the cheek and forehead supports of the tonometer only slightly at a time to prevent the tonometer from getting too close to your eye.
-  **PRECAUTION!** Eye detection is based on the difference of infrared reflections received from the transmitters: the nose side reflects more than the temple side. If the transmitters become dirty, the recognition may be interfered.
-  **PRECAUTION!** Do not cover the eye recognition transmitters or sensor during the measurement, for example with your fingers. Keep your hand, hair, and objects such as pillows away from the temple side of your eye, as they produce an infrared reflection that causes an error.

1. **Before the measurement, adjust the forehead and cheek supports to the correct length. Start with the supports at the maximum length.**

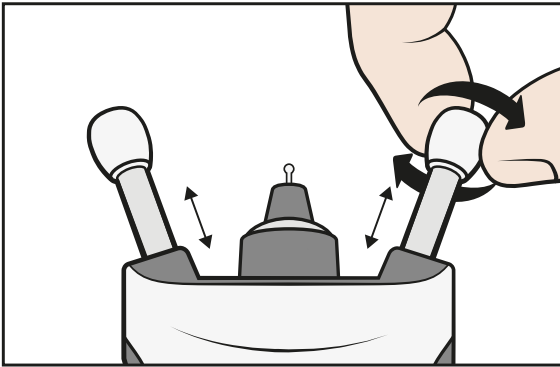

You can take the measurement sitting, standing, or lying down (supine position).

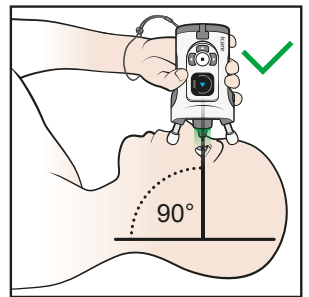
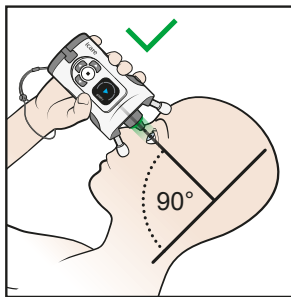
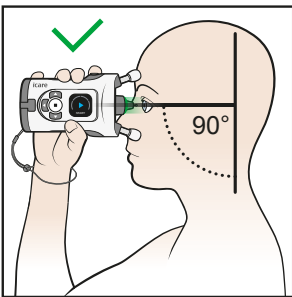

You can hold the device with one or both hands.

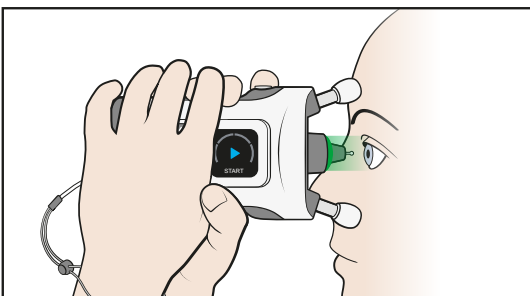

2. Shorten the supports two clicks at a time to prevent the tonometer from getting too close to your eye.

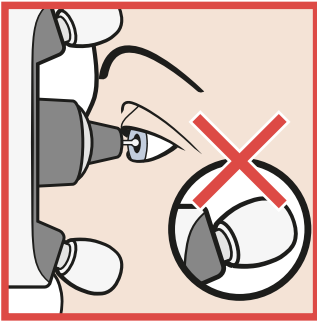

3. Place the tonometer against your face and look into the probe base.

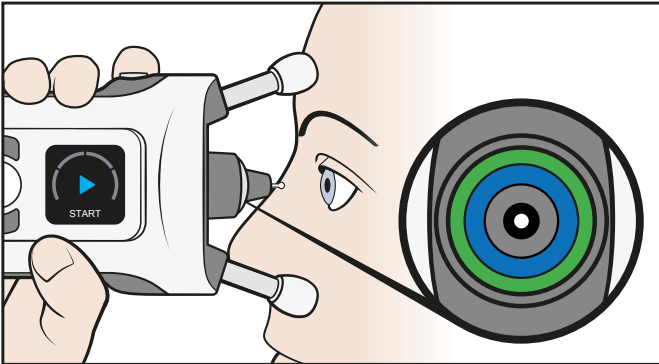

The probe points perpendicularly to the center of your eye when the blue and green rings in the probe base are symmetrical.

4. If the rings are not symmetrical, the probe does not point perpendicularly to the center of your eye. Correct the position of the tonometer.

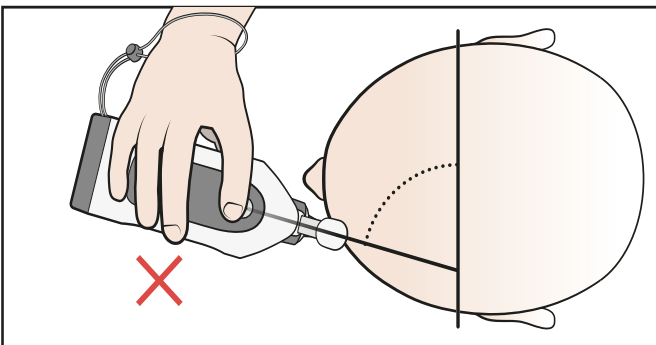
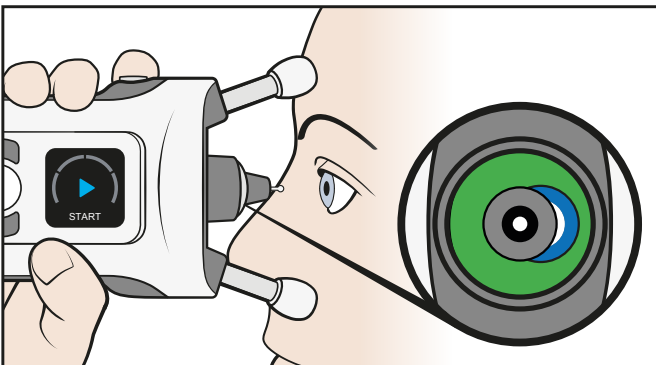

5. Keep both eyes open. Covering the eye not being tested may help you see the rings more clearly.

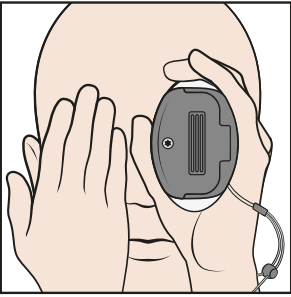

6. Shorten the supports by rotating them clockwise two clicks at a time until you only see a symmetrical green ring. The tonometer is now at the correct distance from your eye.

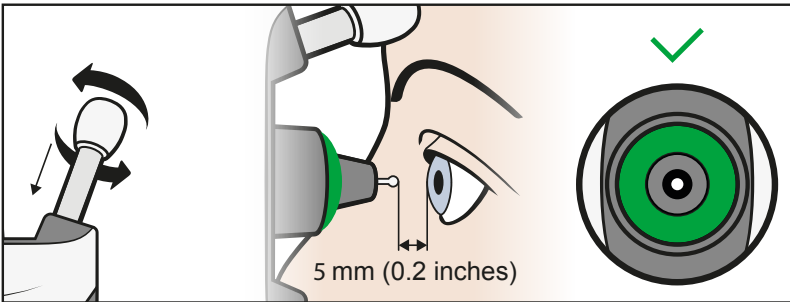

## 8.5 Measure your eye pressure

1. Start the measurement when you see only a symmetrical green ring. Press the Measure button  once. The probe gently touches your eye.

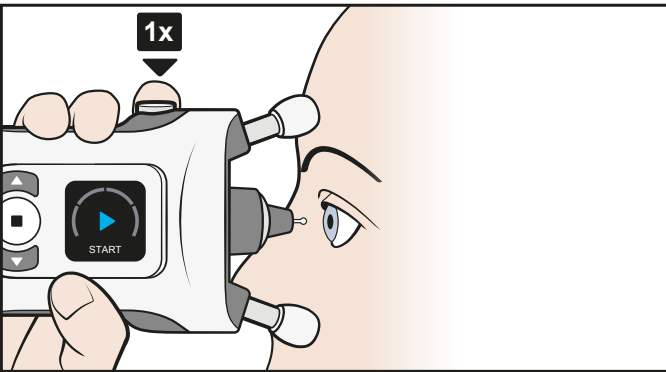

2. A single beep indicates a successful measurement. Continue taking measurements, until you hear a long beep and the light in the probe base turns off.

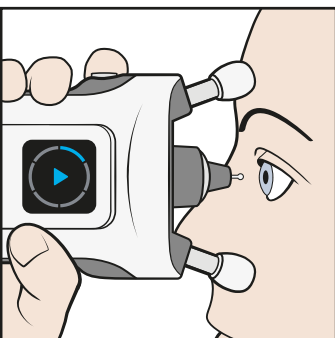

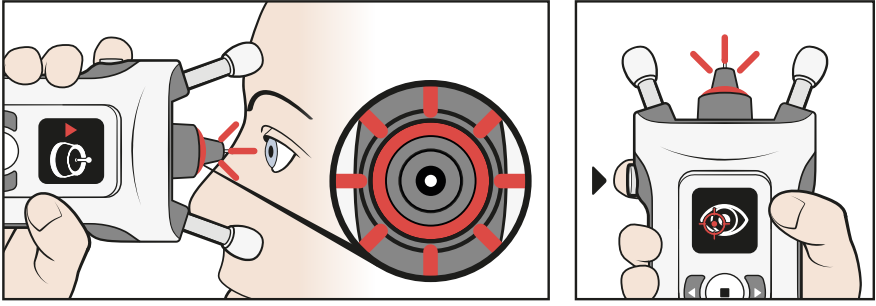

3. If the probe base flashes red and you hear multiple beeps, the measurement was not successful. The display and sounds indicate the source of the error.

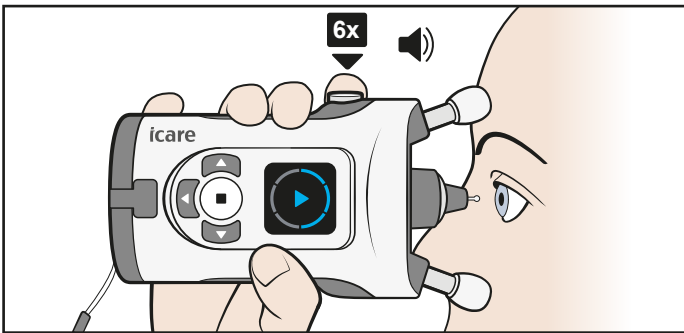

Look at the display and press  to acknowledge the error. Make the necessary corrections and repeat the measurement. The errors and corrective actions are explained in chapter “8.7 Errors during the measurement”.

4. A measurement sequence consists of six measurements.



**NOTE!** You can also take the measurement sequence by pressing and holding the Measure button  down until all six measurements have been taken.

5. When all six measurements have been successfully taken, you hear a longer beep. The display shows the measurement quality.

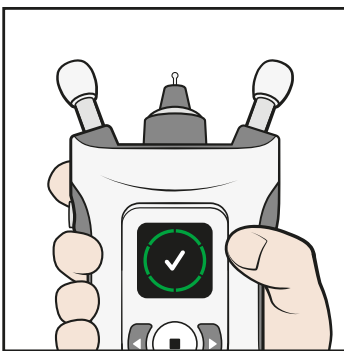

The measurement quality is explained in chapter “8.8 Check the measurement quality”.

**NOTE!** If you suspect that the probe missed the center of your eye or contacted your eyelid, repeat the measurement.

6. Press  and repeat the measurement on your other eye, if needed.

## 8.6 Measure your eye pressure in the supine position

Before measuring, lie down (supine position) for a moment.

1. **Take a comfortable position on your back with a pillow behind your neck. Look straight ahead.**

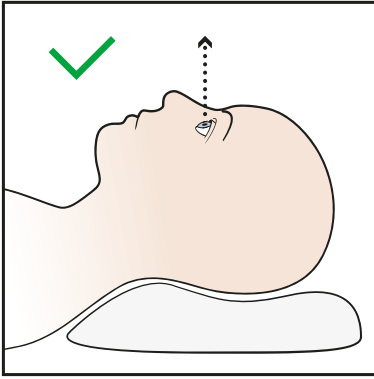

Avoid bending your head and neck backwards.

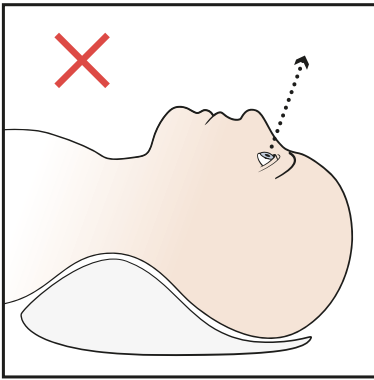

2. **Place the tonometer at a 90 degrees angle on your face and take the measurement as as instructed in 8.5 Measure your eye pressure.**

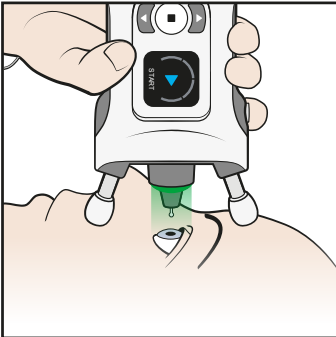





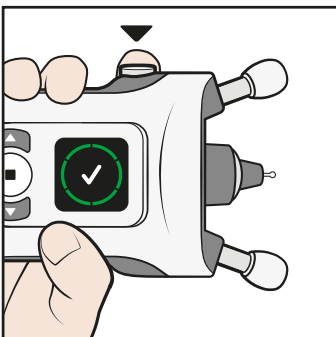









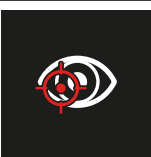





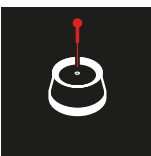

**NOTE!** Before measuring, the forehead and cheek supports may need to be adjusted to be slightly shorter.

3. **After a successful measurement, press the Measure button (▶) once. Repeat the measurement on your other eye.**

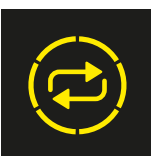

## 8.7 Errors during the measurement

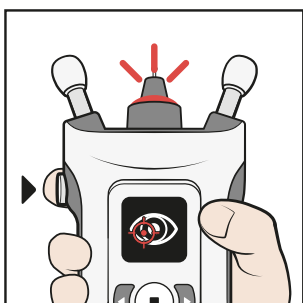

Screen	Text	Sound	Description	Actions
	TOO FAR	3 long beeps 	The measurement was taken too far from the eye. The probe did not touch the eye.	Press the Measure button  once to acknowledge the error. Turn the supports clockwise until the probe is about 5 mm (0.2 inches) from your eye and you see a green light ring.
	TOO NEAR	5 short beeps 	The measurement was taken too close to the eye.	Press the Measure button  once to acknowledge the error. Turn the supports counterclockwise until the probe is about 5 mm (0.2 inches) from your eye.
	INCORRECT ALIGNMENT	2 short beeps 	The probe was not perpendicular to the cornea or the probe hit an eyelid or eyelashes.	Press the Measure button  once to acknowledge the error. Position the tonometer so that the probe points perpendicularly to the center of your eye. Keep your eye properly open.
	REPEAT	2 short beeps 	The probe did not move properly or did not make a clean contact with the cornea.	Press the Measure button  once to acknowledge the error. Measure again or change the probe.
	CHANGE	2 short beeps 	The probe did not move.	Press the Measure button  once to acknowledge the error. Change to a new probe.
	DETECTION ERROR	2 short beeps 	The sensor could not detect which eye was being measured (right or left).	Collect your hair from your temple to behind your ear. Make sure your face is fully uncovered. Press  , then press  until the correct eye (right or left) is shown on the display. Press  to confirm, or press the return button to cancel the measurement.
	REPEAT	2 short beeps 	The variation in the measurements was too high.	Press the Measure button  once to acknowledge the error. Repeat the measurement.

Press  to acknowledge the error and to continue measuring.



## 8.8 Check the measurement quality







After a successful measurement, the quality of the measurement is shown on the display. It is indicated with a color:

	Green: good measurement quality
	Yellow: acceptable measurement quality
	The variation between the measurements was too high. Repeat the measurement.

The tonometer stores the calculated eye pressure reading in mmHg, the time and date of the measurement, information on which eye was measured and the quality of the measurement. You can view your eye pressure readings using a mobile phone or a computer. For more information, see chapter “12 iCare software system”.

The measurement quality is an indication of how much variation there was between the six individual measurement results. The measurement quality indication (green or yellow) is not related to the level of eye pressure

## 8.9 View information on your previous measurements

1. Press  after you have seen the quality of the measurement on the display..
2. Press  until you see **HISTORY** on the display.
3. Press .
4. Press  and  to view to view the time and date of the measurement. The tonometer shows the last 100 measurement results.
5. To exit the view, press .

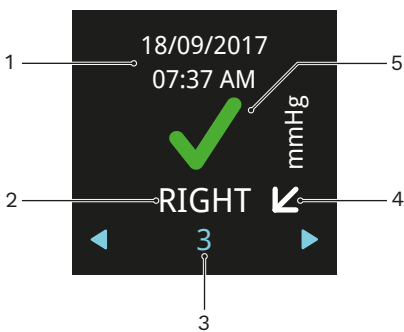

1–Date and time of the measurement

2–Measured eye

3–Measurement ordinal

4–Horizontal arrow indicates that you were standing or sitting during the measurement, diagonal arrow indicates tilted position, and vertical arrow



indicates that you were lying down (supine position)

5–Green result means good measurement quality, yellow means acceptable quality.

See chapter “12.3 Transfer measurement data to iCare CLINIC or iCare CLOUD” for advice on how to transfer your measurement results to the iCare CLINIC or the iCare CLOUD.

## 9 Switch off the tonometer and dispose of the probe

To switch off the tonometer, press and hold down  until you hear 3 beeps and the display turns off. The tonometer turns off if you don't use it for three minutes.

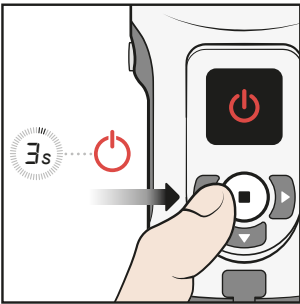

Remove the probe and put it back to the probe container.

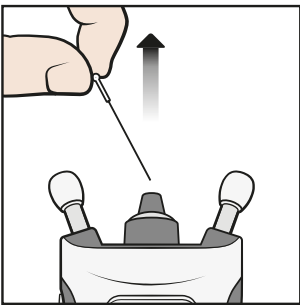

Dispose of the probe and container in a mixed waste bin.



## 10 Tonometer modes

### 10.1 Practice mode

If you want to practice with the tonometer before taking a measurement, use the practice mode. In the practice mode, you take 10 measurements, and the display shows if a measurement was successful: the blue segments on the circle are successful measurements and the red ones unsuccessful. These measurement results are not stored on the tonometer's memory.

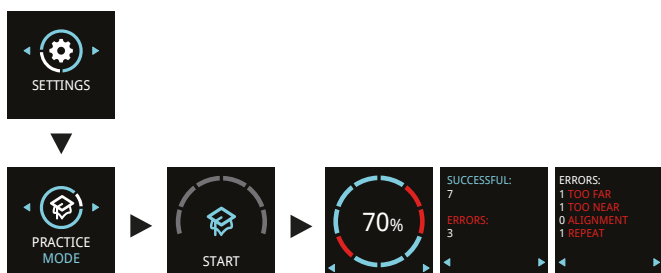

1. Press and hold down to switch on the tonometer.
2. Press until you see **SETTINGS** on the display.
3. Press .
4. Press until you see **PRACTICE MODE** on the display.
5. Press .
6. Insert the probe to the tonometer.
7. Press .
8. Adjust the tonometer to your face and press 10 times.

When the tonometer shows your success rate, press the navigation buttons to see what kind of errors occurred during the practice measurements. To measure again, press , or press to return to the settings.

## 10.2 Rental mode

With the iCare CLINIC software, the healthcare professional can set the tonometer to the rental mode which allows the healthcare professional to set a rental time for the tonometer. During the rental time, the patient can take measurements with the tonometer. Once the rental time expires, the patient can no longer take measurements with the tonometer.

For instructions on setting the rental mode, see the iCare CLINIC, EXPORT and PATIENT2 Instruction Manual for Healthcare Professionals.



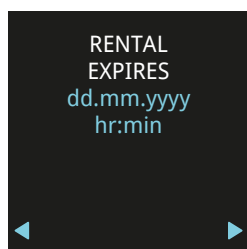

To see when the rental expires:

1. Press and hold down to switch on the tonometer.
2. Press until you see **INFO**.
3. Press .
4. Press .
5. To exit the view, press .







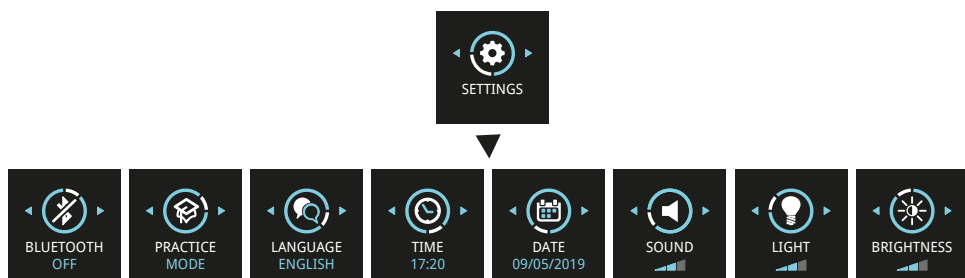

## 11 Tonometer settings

1. Press and hold down to switch on the tonometer.
2. Press until you see **SETTINGS** on the display.















3. Press .
4. Press  or  to move between the various settings.
5. To select a setting, press .
6. To exit the settings, press .

















## 11.1 Language settings

1. To change the language, press  or  until you see **LANGUAGE**.
2. Press .
3. Press  or  until you see the language you want, and press .
4. To go back to the settings, press .







## 11.2 Time settings

1. To change the time, press  or  until you see **TIME**.
2. Press .
3. Press  or  until you see the time format you want, and press .
4. Press  or  until you see the time zone you want, and press .
5. Press  or  until you see the hour you want, and press .
6. Press  or  until you see the minutes you want, and press .







## 11.3 Date settings

1. To change the date, press  or  until you see **DATE**.
2. Press .
3. Press  or  until you see the date format you want, and press .
4. Press  or  until you see the year you want, and press .
5. Press  or  until you see the month you want, and press .
6. Press  or  until you see the day you want, and press .







## 11.4 Volume settings

1. To change the volume level, press  or  until you see **SOUND**.
2. Press .
3. Press  or  until you hear the volume level you want, and press .





## 11.5 Probe base light settings

1. To change the brightness of the probe base light, press  or  until you see **LIGHT**.
2. Press .
3. Press  or  until you see the brightness level you want, and press .

## 11.6 Display brightness settings

1. To change the brightness of the display, press  or  until you see **BRIGHTNESS**.
2. Press .
3. Press  or  until you see the brightness level you want, and press .

## 11.7 Tonometer's serial number and firmware version

1. Press and hold  to switch on the tonometer.
2. Press  until you see **INFO** on the display.
3. Press .
4. To exit the view, press .

**NOTE!** The serial number is also printed on the label at the back of the tonometer.

## 12 iCare software system



**WARNING!** When reading the measurement data in a clinic or hospital environment, make sure the tonometer and the computer or mobile device which are not medical equipment are located outside of the patient environment, i.e. 1.5 m (5 feet) from the patient.

The iCare software system consists of the following:

- iCare HOME2 tonometer
- iCare CLINIC, a browser-based software service with which the healthcare professionals and patients can view the measurement data
- iCare PATIENT2 mobile application with which the patients and healthcare professionals can view measurement data and transfer it to the iCare CLINIC cloud service or to the iCare CLOUD
- iCare EXPORT computer software with which the patients and healthcare professionals can transfer measurement results into the iCare CLINIC cloud service, iCare CLINIC On-premises or iCare CLOUD

Patients can store their measurement data to a private account in the iCare CLOUD service, if their tonometer is not registered to a healthcare professional's iCare CLINIC account. For information on how to set up a private account, read the labelling material in the tonometer's carrying case.

You can transfer data from the tonometer using a USB cable connection or Bluetooth®.

Note that if you transfer the measurement results using iCare EXPORT, once you have transferred the results, they will be automatically deleted from the tonometer's memory.

For instructions on using the software system, see the iCare CLINIC, EXPORT and PATIENT Instruction Manual for Healthcare Professionals or the iCare CLINIC, EXPORT and PATIENT Instruction Manual for Patients.

For instructions on using the iCare PATIENT2 app, see iCare PATIENT2 Instruction Manuals (for Android and iOS).

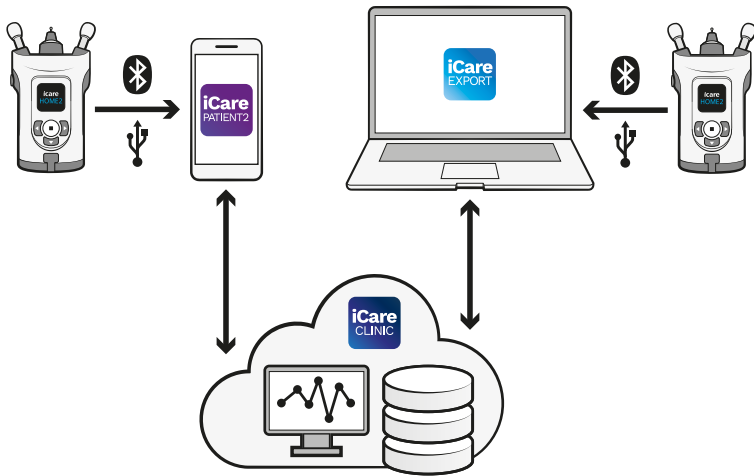

## 12.1 Compliancy standards

The mobile device or computer connected to the iCare HOME2 tonometer within the patient environment must be compliant with IEC 60601-1.

Equipment not complying to IEC 60601-1 must be kept outside the patient environment and must comply to IEC 60950-1 or IEC 62368-1 or a similar safety standard.

Any person who connects a mobile device or a computer to the iCare HOME2 tonometer has formed a Medical Electrical System according to the definition of IEC 60601-1 and is therefore responsible for the system to comply with the requirements of IEC 60601-1. If in doubt, contact Icare USA.

For more information on the iCare software, go to

**<https://www.icare-world.com/us/>**.

The technical specification for the IT network is in chapter “17.3 IT network specifications”.

## 12.2 Install the software

- Before the healthcare professional or the patient can start transferring data from the tonometer to the iCare CLINIC cloud service, the healthcare professional needs to subscribe to iCare CLINIC at **<https://icaremhome.com/>**.
- To install iCare EXPORT on a computer, download the software from the Help menu of iCare CLINIC or at **<https://www.icare-world.com/export/>**.
- To install iCare PATIENT2 on a mobile device, open Google Play (for Android) or App Store (for iOS) on the mobile device and search for iCare PATIENT2. Follow the installation instructions shown on the display.

For information on how to set up a private account to the iCare CLOUD, read the Getting started guide in the tonometer’s carrying case.

The iCare HOME2 tonometer can be connected to either iCare CLINIC or iCare CLOUD, but not both. Patients can store their measurement data to a private account in iCare CLOUD, if their tonometer is not registered to a healthcare professional’s iCare CLINIC account.

## 12.3 Transfer measurement data to iCare CLINIC or iCare CLOUD

### 12.3.1 Use a USB connection



**WARNING!** Do not connect anything to the tonometer's USB port but the USB cable supplied with the tonometer.



**WARNING!** Keep the USB cable out of the reach of children and pets due to the risk of strangulation.



**WARNING!** Do not connect the USB cable to the tonometer's USB port except when uploading patient measurement data. Do not take any measurements when the USB cable is connected.







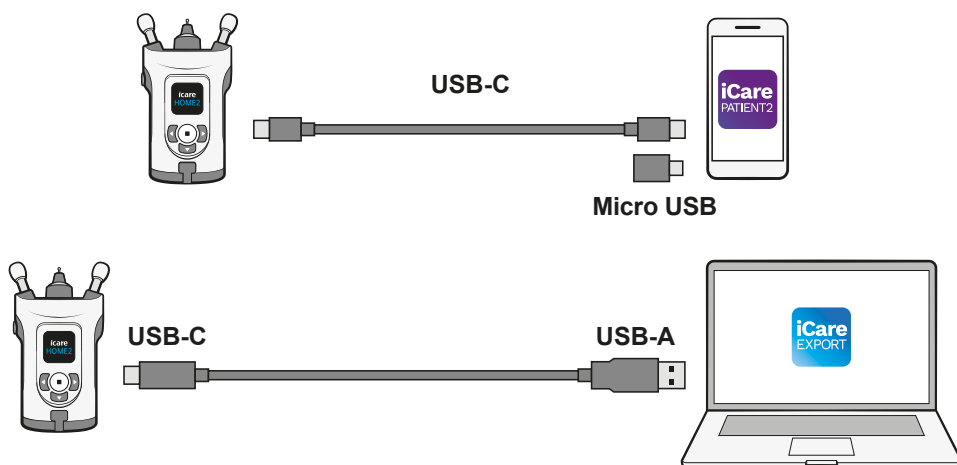

**WARNING!** The tonometer's batteries are not rechargeable. Do not try to charge the tonometer with USB chargers connected to a mains voltage.

**NOTE!** If you have an iPhone, you cannot use the USB connection. Use the Bluetooth connection instead.



1. Open the iCare EXPORT software on your computer, or the iCare PATIENT2 application on your mobile device.
2. Connect the tonometer to your mobile device or computer with the USB cable provided in the tonometer's sales package. If your mobile device has a micro-USB port, use the adapter provided in the sales box.
3. Follow the instructions shown on your mobile device or computer.
4. After removing the USB cable, put the USB cover on the tonometer's USB port.

### 12.3.2 Use a Bluetooth connection

1. Open the iCare EXPORT software on your computer, or the iCare PATIENT2 application on your mobile device.
2. Press and hold  to switch on the tonometer.
3. Press  until you see **SETTINGS** on the display.
4. Press .
5. Press  until you see **BLUETOOTH**, and press .
6. Press  and press .

- On your mobile device or computer, go to the device list, and select the tonometer from the drop-down list. Make sure that the serial number of the tonometer matches with the one at the back of the tonometer.





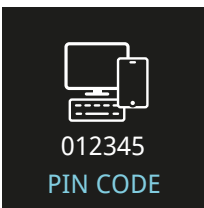

- Once the software prompts you for a PIN code, enter the PIN code you see on the tonometer's display.







If you enter a wrong code, the pairing stops and you need to start it from the beginning.



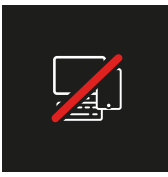

- When you see **BLUETOOTH CONNECTED** on the tonometer display, press .
- Follow the instructions shown on your mobile device or computer.

## 12.4 Bluetooth notifications and errors

Screen	Text	Description	Actions
	BLUETOOTH ON	Bluetooth is on.	
	BLUETOOTH OFF	Bluetooth is off.	
	000000 PIN CODE	Bluetooth PIN code for pairing the tonometer with iCare EXPORT or iCare PATIENT2.	Enter the PIN code on your mobile device or computer.
	BLUETOOTH CONNECTED	Tonometer is connected to iCare EXPORT or iCare PATIENT2.	Press  to acknowledge the notification.

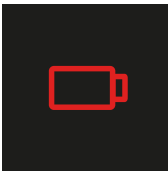
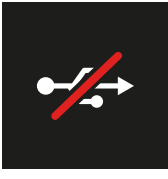
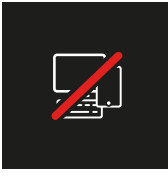
Screen	Text	Description	Actions
	PAIRING CANCELLED	Pairing stopped.	Press  to acknowledge the notification, and repeat the pairing process from the start, if needed.
	BLUETOOTH ERROR	PIN code was incorrect, or iCare EXPORT or iCare PATIENT2 removed the pairing.	Press  to acknowledge the notification, and repeat the pairing process from the start.

## 13 Troubleshooting

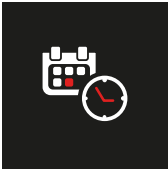
Screen	Text	Description	Actions
	CHANGE	Batteries are empty.	Insert new batteries.
		USB connection error.	Remove the USB cable from the tonometer and connect it again.
	BLUETOOTH ERROR	PIN code was incorrect, or iCare EXPORT or iCare PATIENT2 removed the pairing.	Press  to acknowledge the notification, and repeat the pairing process from the start.
	SERVICE ID	Internal error.	Write down the service ID shown on the display. Switch off the tonometer. Contact the organization from which you obtained the tonometer or Icare USA to arrange service for the tonometer. See chapter “14.4 Return the tonometer for service or repair”.
		Force shutdown error. The tonometer displays the error code (NN) for 3 seconds and shuts down.	Switch the tonometer on. If the error occurs repeatedly, contact the organization from which you obtained the tonometer or Icare USA to arrange service for the tonometer.
	RENTAL EXPIRED	Tonometer’s rental time has expired, and measuring is disabled.	Return the rented tonometer to the clinic or discuss extending your rental period with the clinic.



## 14 Maintenance



**WARNING!** The tonometer should only be opened by qualified iCare service personnel. The tonometer does not contain any user-serviceable parts, apart from the batteries and the probe base. The tonometer does not require any routine servicing or calibration other than changing the batteries at least annually and the probe base every six months. If there is a reason to believe that the servicing of the tonometer is necessary, contact the manufacturer or local distributor.



**WARNING!** The tonometer must not be repaired or re-assembled by any other than the manufacturer or its authorized service center. If the tonometer is broken, do not use it. Take it to an authorized iCare service center for repair.



**WARNING!** To avoid possible damage, keep the tonometer out of the reach of children and pets. The probe base, battery cover, screws, collar, and probes are small objects and may be accidentally swallowed.



**WARNING!** Do not change the batteries or the probe base when the USB cable is connected.



**WARNING!** Servicing or maintenance actions must not be performed while the tonometer is in use.

### 14.1 Replace the probe base



**WARNING!** The tonometer must be switched off when the probe base is changed.



**WARNING!** The probe base must be changed, not cleaned.



**PRECAUTION!** To ensure the correct functioning of the tonometer, change the probe base every six months.

**NOTE!** Change the probe base if the tonometer constantly prompts REPEAT or CHANGE and changing the probe does not resolve the issue.

The probe base may function improperly if dirt or liquid gets inside it.

1. **Switch off the tonometer.**
2. **Turn the probe base collar counterclockwise until it becomes loose.**

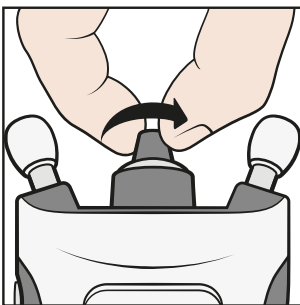

3. **Lift the collar off the tonometer.**

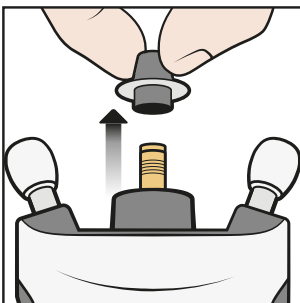

4. Pull the probe base off.

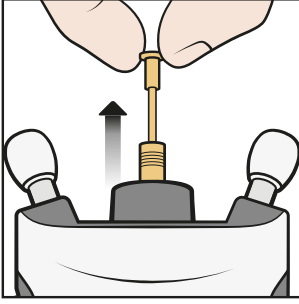

5. Insert a new probe base into the tonometer.

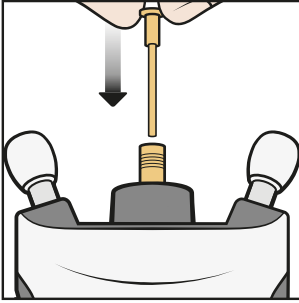

6. Put the collar back to the tonometer.

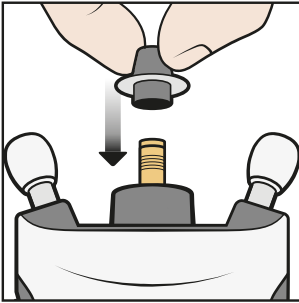

7. Turn the collar clockwise until it is firmly in place. Do not use excess force.

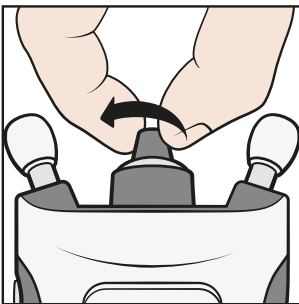

Dispose of the used probe base. To order new probes or probe bases, contact the organization from which you obtained the tonometer or Icare USA.

## 14.2 Clean and disinfect the tonometer



**WARNING!** Never immerse the tonometer in liquid. Do not spray, pour, or spill liquid on the tonometer, its accessories, connectors, switches, or openings in the cover. Immediately remove any liquid from the surface of the tonometer.



**WARNING!** The probe base must be changed, not cleaned.



**PRECAUTION!** Certain microbiological agents (for example, bacteria) can be transmitted from the forehead or cheek support. To prevent this, clean the forehead and cheek supports with disinfectant for each new patient.

To prevent cross-contamination, the healthcare professional must disinfect the outer surfaces of the tonometer using 70%-100% isopropyl alcohol or 70% ethanol before lending the tonometer to patients. If the tonometer gets dirty during use, the patient should clean it with a cloth or paper towel dampened with water.

To clean the applicator, wipe it with 70% ethanol or 70%-100% isopropyl alcohol or rinse it with sterile purified water and then make sure that it is completely dry before use.

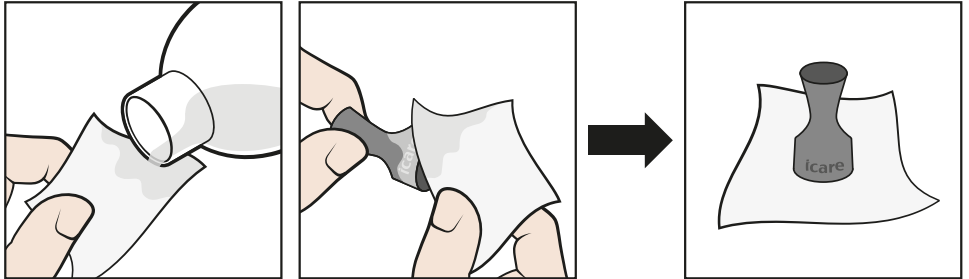

### 14.3 Lifetime

The expected service life of the tonometer is 5 years. The maintenance procedures described in this manual are required during the expected service life.

The shelf life of the probes in their intact original packaging is 3 years. Check the expiry date from the probe package label.

Inspect the tonometer for mechanical and functional damage and the safety labels for legibility and integrity annually. Contact the manufacturer or local distributor if you detect any damage or deterioration.

A set of batteries is expected to last over 1000 measurements in normal use. The performance of the batteries may vary depending on the battery brand and model.

### 14.4 Return the tonometer for service or repair

**NOTE!** Before contacting for service, write down the serial number of your tonometer, the LOT number of the probe package in use and, if applicable, the service ID number from the tonometer display.

Contact the organization from which you obtained the tonometer or Icare USA's technical services department (go to <https://www.icare-world.com/us/>) for shipping instructions. Unless otherwise instructed by Icare USA, there is no need to ship any accessories with the tonometer. Use a suitable cardboard or similar box with the appropriate packaging material to protect the tonometer during shipment. Return the tonometer using any shipping method that includes a proof of dispatch and delivery.

**NOTE!** For assistance in setting up, using, or maintaining the tonometer or to report unexpected operation or events, contact the manufacturer or manufacturer's representative.

### 14.5 Recycle



Do not dispose of the tonometer with household waste. Send it to an appropriate facility for recovery and recycling. The tonometer should be recycled as electronic waste.

The separate collection and recycling of your product or its battery at the

time of disposal help conserve natural resources and ensure that it is recycled in a manner that protects human health and the environment.

The sales package and the probe boxes are carton and can be recycled. Waste carton generally includes paper, carton, and cardboard packages. Recycle according to local laws and regulations.

Put the probes back to their containers and dispose of as mixed waste.



The plastic probe boxes are of polypropylene. Dispose or recycle them as plastic according to local laws and regulations.

## 15 Glossary

- Cornea: the eye's outermost dome-shaped clear layer
- Expected service life: expected lifetime before replacement
- Forehead/cheek supports: the tonometer's adjustable supports
- GAT: Goldmann applanation tonometry, the standard eye test that can detect your eye pressure
- Intraocular pressure: eye pressure
- IOP: intraocular pressure
- mmHg: the unit of measurement for the eye pressure
- Probe: the tonometer's single-use item that lightly touches your eye
- Probe base: a replaceable part that guides the probe's movement during measurements
- Probe base light: colored light rings or a solid light help you place the tonometer correctly on your face
- Shelf life: the time that the probe remains sterile in its intact packaging
- Supine position: lying on your back with your face upwards

## 16 Accessories, parts, and other supplies

SKU	Product description	Weight (in pounds)	Dimensions WxHxL (in inches)
<b>Accessories</b>			
114	Probe iCare TP022, 20 pcs/box	50 g (0.11 lbs)	31 mm x 53 mm x 103 mm (1.2" x 2.1" x 4.1")
113	Probe iCare TP022, 50 pcs/box	56 g (0.12 lbs)	35 mm x 82 mm x 195 mm (1.4" x 3.2" x 7.7")
<b>Parts</b>			
540	Probe base	4 g (0.008 lbs)	7 mm x 38 mm (0.3" x 1.5")
559	Wrist strap with lock	4 g (0.008 lbs)	10 mm x 10 mm x 270 mm (0.4" x 0.4" x 10.7")
551	Probe applicator	6 g (0.01 lbs)	28 mm x 51 mm (1.1" x 2.0")
<b>Other supplies</b>			
7214	Probe base collar, iCare HOME2	2 g (0.004 lbs)	19.5mm x 19.5mm (0.8" x 0.8")
577F	USB manual, iCare HOME2		
575B	USB cable for PC connection- Type C male to A male	30 g (0.07 lbs)	1 m (39.4")
648B	USB cable-Type C male to C male+USB C to B adapter	6 g (0.01 lbs)	20 cm (7.9")
528	Carrying case for iCare HOME2	310 g (0.68 lbs)	88 mm x 145 mm x 315 mm (3.5" x 5.7" x 12.4")

SKU	Product description	Weight (in pounds)	Dimensions WxHxL (in inches)
548B	Screwdriver Torx TX8	15 g (0.03 lbs)	16 mm x 90 mm (0.6" x 3.5")

## 17 Technical information

### 17.1 Technical description



**WARNING!** Do not modify the tonometer in any way. Changes or modifications not expressly approved by the manufacturer could void the user's authority to operate the tonometer.

**NOTE!** A separate service manual is available for service personnel.

**Type:** TA023

**Dimensions (WxHxL):** 50 mm x 94 mm x 152 mm (supports extended to maximum) / 2.0" x 3.7" x 6.0" (supports extended to maximum)

**Weight:** 205 g (without batteries) / 0.45 lbs (without batteries), 300 g (with 4 x AA batteries) / 0.66 lbs (with 4 x AA batteries)

**Power supply:** 4 x 1.5 V, AA, non-rechargeable batteries, alkaline LR6

**Measurement range:** 7 – 50 mmHg

**Accuracy:**  $\pm 1.2$  mmHg ( $\leq 20$  mmHg) and  $\pm 2.2$  mmHg ( $> 20$  mmHg)

**Repeatability (coefficient of variation):**  $< 8\%$

**Precision of display:** 1 mmHg

**Display unit:** millimeters of mercury (mmHg)

#### Operation environment:

**Temperature:** +10 °C to +35 °C (50 °F to 95 °F)

**Relative humidity:** 30 % to 90 %

**Atmospheric pressure:** 800 hPa to 1,060 hPa

#### Storage environment:

**Temperature:** -10 °C to +55 °C (14 °F to 131 °F)

**Relative humidity:** 10 % to 95 %

**Atmospheric pressure:** 700 hPa to 1,060 hPa

#### Transport environment:

**Temperature:** -40 °C to +70 °C (-40 °F to 158 °F)

**Relative humidity:** 10 % to 95 %

**Atmospheric pressure:** 500 hPa-1,060 hPa

**NOTE!** It is recommended to let the tonometer temperature stabilize for about an hour to room temperature before taking the tonometer to use after transport or storage.

The tonometer and its materials are compliant with RoHS Directive 2011/65/EU. The tonometer and its parts are not made of natural rubber latex.

Method of sterilization of the probes: gamma-irradiation

Mode of operation: continuous

The serial number is located on the back of the tonometer. The LOT number of the probes is on the side of the probe box and the blister packing. There are no electrical connections from the tonometer to the patient. All the parts of the tonometer are applied parts and the tonometer has BF-type electric shock protection.

### 17.2 System requirements for iCare CLINIC

- Internet connection
- Minimum web browser versions: IE 11, Chrome (v 58), Firefox (v 53) and Safari (5.1.7)

## 17.2.1 Minimum computer requirements for iCare EXPORT

- x86 or x64 1 GHz Pentium processor or equivalent
- 512 MB RAM
- 512 MB of hard disk space (in addition, 4.5 GB if .NET not already installed)
- USB 2.0 connection
- 800 x 600 resolution display with 256 colors
- DirectX 9 compatible graphics card
- .NET Framework 4.6.1 or greater
- Operating System: Windows 10
- Internet connection
- Using Bluetooth requires a computer with Windows 10 version 1703 or newer and Bluetooth BLE card / chip.

## 17.2.2 Minimum system requirements for iCare PATIENT2

- Android smart phone or tablet with USB OTG support, operating system v6.0 or newer or iPhone with operating system iOS 12 or newer
- USB OTG C male – C male cable, supplied with the tonometer
- Internet connection

To verify the required USB OTG support in the smart phone or tablet, use the **OTG?** application available on Google Play or another application providing similar functionality.

## 17.3 IT network specifications



**WARNING!** Connection of the tonometer to IT networks including other equipment could result in previously unidentified risks to patients, operators, or third parties.



**WARNING!** The responsible organization should identify, analyze, evaluate, and control any additional risks resulting from the tonometer connected to IT networks including other equipment.



**PRECAUTION!** Changes to the IT network could introduce new risks requiring additional analysis by the responsible organization. The changes include:

- changes in the IT network configuration
- connection of additional items to the IT network
- disconnecting items from the IT network
- update or upgrade of equipment connected to the IT network

To transfer the measurement data from the tonometer to a mobile device or a computer, the tonometer must be connected via Bluetooth or USB. The mobile device or computer must be connected to the internet or the hospital's IT network. The tonometer can be used as a stand-alone without a Bluetooth or USB connection. The tonometer is designed in such a way that network failures do not prevent the tonometer from working normally.

## 17.4 Intended information flow

The iCare HOME2 tonometer collects measurement data. This data is sent via Bluetooth or USB connection to a computer (Bluetooth Low Energy, BLE) which has the iCare EXPORT software installed or to a mobile device with the iCare PATIENT2 application installed.

iCare EXPORT or iCare PATIENT2 transfers the data into the iCare CLINIC software. You can access the data online using the iCare CLINIC software with a web browser.

## 17.5 Potential hazardous situations resulting from the failure of the IT network

If the IT network connection is lost during the data transfer, no data is lost

from the tonometer. The measurement data can still be found from the tonometer memory and transferred once the connection is re-established.

Failure or misconfiguration of the IT network may result in data not being transferred.

## 17.6 Required characteristics of the IT network

The responsible organization is strongly recommended to maintain virus protection up to date on the computers and mobile devices used. The responsible organization is also recommended to install security updates to the used web browsers, computers, and mobile devices when available.

## 17.7 Performance data

### 17.7.1 Clinical performance data

A clinical study was conducted to analyze the variability of the intraocular pressure (IOP) self-measurements with the iCare HOME2 tonometer in comparison to the variability of the IOP measurements with the reference tonometer (iCare IC200, ANSI Z80.10-2014 compliant) over a wide range of IOP measurement values.

The performance data was obtained from a clinical study. The study was performed at East West Eye Institute, CA 90013, USA, and included 47 patients. All patients were found to be eligible for analysis. All the patients were either diagnosed glaucoma patients or 'glaucoma-suspects'. A random eye was selected as the study eye for each patient.

**Safety:** No adverse events (including corneal abrasions) were recorded in the study population.

**Results:** The mean paired difference and standard deviation (iCare HOME2 - iCare IC200) were 0.55 mmHg and 2.69 mmHg.

The iCare HOME2's variability (difference of repeat measurements) for each patient was ~7.9% for all the IOP ranges.

### Summary of study results (sitting and supine positions)

Group	N	HOME2	Reference, IC200	Difference	95% CI for Mean Difference	95% LOA for Mean Difference
		Mean (SD)	Mean (SD)	Mean (SD)		
≤ 16 mmHg	24	15.78 (2.86)	14.86 (2.9)	-0.93 (2.75)	-1.38, -0.48	-6.32, 4.46
>16 to <23 mmHg	13	20.17 (2.28)	19.56 (2.75)	-0.6 (2.66)	-1.2, -0.00	-5.81, 4.61
≥ 23 mmHg	10	23.88 (2.34)	24.33 (2.42)	0.44 (2.36)	-0.17, 1.05	-4.19, 5.07
Overall	47	18.72 (4.17)	18.17 (4.67)	0.55 (2.69)	-0.86, -0.23	-5.82, 4.72



**PRECAUTION!** Please be advised that the measurement results may vary between an IOP self-measurement and an IOP measurement performed by a healthcare professional.

In a clinical trial, the mean difference between the measurements performed by a healthcare professional and an IOP self-measurement was -1.45 mmHg for sitting position and 0.71 mmHg for supine position. The overall mean difference between self-measured IOP values and healthcare professional measured IOP values was 0.55 mmHg.

### 17.7.2 Bench test results

Repeatability of iCare HOME2 tonometer was assessed in bench tests. The tests were done by measuring a manometrically controlled artificial cornea. The test pressures (7, 10, 20, 30, 40, and 50 mmHg) covered the specified measurement range of iCare HOME2 tonometer. To assess repeatability, 10 measurements were performed with the iCare HOME2 tonometer at three different measurement angles (the probe pointing at the artificial cornea at 0, 45, and 90 degrees to the horizontal).











iCare HOME2 tonometer demonstrated agreement with the true manometric pressures, R-squared values being at least 99.7%, regardless of the angle of measurement (0, 45 or 90 degrees). On average, the iCare HOME2 tonometer underestimated the pressure by 0.04 mmHg with respect to the true manometric pressures with standard deviation of 0.37 mmHg.

Reproducibility was assessed by a test in which two operators performed three measurements with three different iCare HOME2 tonometers. Three different pressure levels (7, 10, 20, 30, 40 and 50 mmHg) and three different angles (0, 45, and 90 degrees) were used. The mean difference between the operators was 0.14 mmHg with a standard deviation of 1.21 mmHg. The R-squared value in regression analysis was 99.4%, which indicates high reproducibility across the operators and the iCare HOME2 tonometers.













Please be advised that bench testing conditions do not cover all the error sources within a clinical setting and thus higher variability is expected in clinical use.

Due to the controlled test environment, the standard deviation of the bench tests do not reflect the measurement variability that can be expected in actual home use.

### 17.8 Symbols and trademarks

	Caution		Batch code LOT number
	Consult instructions for use		Date of manufacture
	Serial number		Sterilized using irradiation
	Single use Do not re-use		Keep dry
	Use by		Non-ionizing electromagnetic radiation



<b>IP22</b>	Protected against access to hazardous parts with a finger. Protected against solid foreign objects of 12,5 mm Ø and greater. Protected against vertically falling water drops when enclosure tilted up to 15°.		Manufacturer
	Type BF applied part		EU WEEE (European Union Directive for Waste of Electronic and Electrical Equipment) symbol.  Do not dispose of this product with household waste. Send to appropriate facility for recovery and recycling.
<b>Rx Only (U.S.)</b>	Federal law (U.S.) restricts this device to sale by or on the order of a physician or properly licensed practitioner.		Bluetooth communication
	The Regulatory Compliance Mark (RCM), in Australia and New Zealand		Technical conformity mark and certification number of the Ministry of Internal Affairs and Communications of Japan (MIC)
	Refer to the instruction manual		Product is a medical device
	Temperature limit		Humidity limitation
	Atmospheric pressure limitation		Recyclable package material
	CE mark		

## 17.9 Information for the user regarding the radio communication part of the tonometer

The iCare HOME2 tonometer contains a Bluetooth transmitter working at frequencies between 2.402 GHz and 2.480 GHz. Due to the limited physical size of the tonometer, many of the relevant approval markings are found in this document.

## 17.10 Bluetooth module information

Item	Specification
Bluetooth module	RN4678 Bluetooth 4.2 Dual Mode
Communication	Bluetooth Low Energy (LE)
Radio Frequency (RF) range	2.402 GHz – 2.480 GHz
Output power	< 2.5 mW (4 dBm), Class 2
Antenna gain	1.63 dBi
Effective radiated power	< 2.2 mW (3.4dBm)
Transmitting distance	10 meters (30 feet)

FCC ID: A8TBM78ABCDEFGH

IC: 12246A-BM78SPPS5M2

MIC: 202-SMD070

### 17.11 Statement of compliance

This device complies with Part 15 of the FCC rules and RSS-210 of Industry Canada. Operation is subject to the following two conditions:

- This device may not cause harmful interference,
- This device must accept any interference received, including interference that may cause undesired operation

Changes or modifications not expressly approved by Icare USA could void the user's authority to operate the equipment.

This equipment has been tested and found to comply with the limits for a Class B digital device, pursuant to part 15 of the FCC Rules. These limits are designed to provide reasonable protection against harmful interference in a residential installation. This equipment generates, uses and can radiate radio frequency energy, and if not installed and used in accordance with the instructions, may cause harmful interference to radio communications. However, there is no guarantee that interference will not occur in a particular installation. If this equipment does cause harmful interference to radio or television reception, which can be determined by turning the equipment off and on, the user is encouraged to try to correct the interference by one or more of the following measures:

- Reorient or relocate the receiving antenna.
- Increase the separation between the equipment and receiver.
- Connect the equipment into an outlet on a circuit different from that to which the receiver is connected.
- Consult the dealer or an experienced radio/TV technician for help.



This Product operates in the unlicensed ISM band at 2.4GHz. In case this Product is used around the other wireless devices including microwave and wireless LAN, which operate same frequency band of this Product, there is a possibility that interference occurs between this Product and such other devices. If such interference occurs, please stop

the operation of other devices or relocate this Product before using this Product or do not use this product around the other wireless devices

## 17.12 Electromagnetic declaration



**WARNING!** Use of this equipment adjacent to or stacked with other equipment should be avoided because it could result in improper operation. If such use is necessary, this equipment and the other equipment should be observed to verify that they are operating normally.



**WARNING!** Use of accessories, transducers and cables other than those specified or provided by the manufacturer of this equipment could result in increased electromagnetic emissions or decreased electromagnetic immunity of this equipment and result in improper operation.



**WARNING!** Interference may occur in the vicinity of equipment marked with the non-ionizing radiation symbol.



**PRECAUTION!** Non-ME equipment (computer or mobile device) used in the system for transferring data must comply with the electromagnetic emission and immunity requirements for multimedia equipment: CISPR 32 and CISPR 35.



**PRECAUTION!** The measurement method of the tonometer is based on a magnetically induced motion of a probe and therefore an external magnetic or radiated RF electromagnetic field disturbing the probe may prevent the measurement. In such a case the tonometer continuously displays error messages during measurement and asks you to repeat the measurement. Situation can be solved either by removing the source of interference from the vicinity of the device or by performing the measurement in different location with no such interference.



**PRECAUTION!** The measurement data transfer may be interrupted during electromagnetic disturbance. In such case, reconnect the tonometer to the computer or mobile device. If this does not solve the issue, perform the data transfer in other location with no such interference. The measurement data will not be deleted from the device before the data is transferred successfully.



**PRECAUTION!** Portable and mobile RF communications equipment can affect the tonometer.



**PRECAUTION!** Although the tonometer's own electromagnetic emissions are well below the levels permitted by the relevant standards, they may cause interference in other, nearby devices, for example sensitive sensors.

The iCare HOME2 tonometer is a class B equipment and needs special precautions regarding EMC and needs to be installed and put into service according to EMC information provided in following tables.

<b>Guidance and Manufacturer's Declaration IEC 60601-1-2:2014; Edition 4.0</b>		
<b>Electromagnetic Emissions</b>		
iCare HOME2 tonometer (TA023) is intended for use in a home healthcare environment with electromagnetic characteristics specified below. The user of the iCare HOME2 tonometer (TA023) should assure that it is used in such an environment.		
RF emissions CISPR 11	Group 1	iCare HOME2 (TA023) is battery-operated and uses RF energy only for its internal function. Therefore, its RF emissions are low and are not likely to cause any interference in nearby equipment.
RF emissions CISPR 11	Class B	iCare HOME2 (TA023) is suitable for use in all establishments, including domestic establishments and those directly connected to public low-voltage power supply network that supplies buildings used for domestic purposes
Harmonic emissions IEC 61000-3-2	NOT APPLICABLE	NOT APPLICABLE
Voltage fluctuations flickering emissions IEC 61000-3-3	NOT APPLICABLE	NOT APPLICABLE

**Guidance and Manufacturer's Declaration IEC 60601-1-2:2014; Edition 4.0**

**Electromagnetic Immunity**



iCare HOME2 tonometer (TA023) is intended for use in a home healthcare environment with electromagnetic characteristics specified below. The user of the iCare HOME2 tonometer (TA023) should assure that it is used in such an environment.

<b>Immunity test</b>	<b>IEC 60601 Test level</b>	<b>Compliance level</b>	<b>Electromagnetic environment-Guidance</b>
Electrostatic discharge (ESD) IEC 61000-4-2	± 8 kV contact ± 15 kV air	± 8 kV contact ± 15 kV air	Floors should be wood, concrete, or ceramic tile. If floors are covered with synthetic material, the relative humidity should be at least 30%
Electrical fast Transients / burst IEC 61000-4-4	± 2 kV 100 kHz repetition frequency	NOT APPLICABLE	NOT APPLICABLE
Surge IEC 61000-4-5	±1 kV for line(s) to line(s) ±2 kV for line(s) to earth	NOT APPLICABLE	NOT APPLICABLE
Voltage dips, short interruption and voltage variations on power supply lines IEC 61000-4-11	0 % UT for 0.5 cycle (1 phase) 0 % UT for 1 cycle 70 % UT for 25/30 cycles (50/60 Hz) 0 % UT for 250/300 cycles (50/60 Hz)	NOT APPLICABLE	NOT APPLICABLE
Power frequency (50/60 Hz) magnetic field IEC 61000-4-8	30 A/m	30 A/m	Power frequency magnetic fields should be at levels characteristic of a typical location in a typical commercial or hospital environment.   <b>WARNING!</b> Sources of power frequency magnetic field should be used no closer than 15 cm (6 inches) to any part of iCare HOME2 (TA023), including cables specified by the manufacturer, to avoid the degradation of performance.

**Guidance and Manufacturer's Declaration IEC 60601-1-2:2014; Edition 4.0**

**Electromagnetic Immunity**



iCare HOME2 tonometer (TA023) is intended for use in a home healthcare environment with electromagnetic characteristics specified below. The user of the iCare HOME2 tonometer (TA023) should assure that it is used in such an environment.

Immunity test	IEC 60601 test level	Compliance level	Electromagnetic environment-Guidance
Conducted disturbances induced by RF fields IEC 61000-4-6	3 V 0,15 MHz – 80 MHz  6 V in ISM and amateur radio bands between 0,15 MHz and 80 MHz  80 % AM at 1 kHz	3 V  6 V	 <b>WARNING!</b>  Portable RF communications equipment (including peripherals such as antenna cables and external antennas) should be used no closer than 30 cm (12 inches) to any part of the iCare HOME2 (TA023), including cables specified by the manufacturer, to avoid the degradation of performance.
Radiated RF IEC 61000-4-3	10 V/m 80 MHz – 2,7 GHz	10 V/m	 <b>WARNING!</b>  Portable RF communications equipment (including peripherals such as antenna cables and external antennas) should be used no closer than 30 cm (12 inches) to any part of the iCare HOME2 (TA023) including cables specified by the manufacturer, to avoid the degradation of performance. Interference may occur in the vicinity of equipment marked with the following symbol:  

**Guidance and Manufacturer's Declaration IEC 60601-1-2:2014; Edition 4.0**

**Electromagnetic Immunity**

iCare HOME2 tonometer (TA023) is intended for use in a home healthcare environment with electromagnetic characteristics specified below. The user of the iCare HOME2 tonometer (TA023) should assure that it is used in such an environment.

Immunity test	IEC 60601 test level	Compliance level	Electromagnetic environment-Guidance
Proximity fields from RF wireless communications equipment IEC 61000-4-3	380 - 390 MHz 27 V/m; PM 50%; 18 Hz	27 V/m	 <b>WARNING!</b> Portable RF communications equipment (including peripherals such as antenna cables and external antennas) should be used no closer than 30 cm (12 inches) to any part of the iCare HOME2 (TA023) including cables specified by the manufacturer, to avoid the degradation of performance. Interference may occur in the vicinity of equipment marked with the following symbol: 
	430 - 470 MHz 28 V/m; (FM ±5 kHz, 1 kHz sine) PM; 18 Hz	28 V/m	
	704 - 787 MHz 9 V/m; PM 50%; 217 Hz	9 V/m	
	800 - 960 MHz 28 V/m; PM 50%; 18 Hz	28 V/m	
	1700 - 1990 MHz 28 V/m; PM 50%; 217 Hz	28 V/m	
	2400 - 2570 MHz 28 V/m; PM 50%; 217 Hz	28 V/m	
	5100 - 5800 MHz 9 V/m; PM 50%; 217 Hz	9 V/m	





**Icare Finland Oy**

Äyritie 22

01510 Vantaa, Finland

Ph. +358 0 9775 1150

info@icare-world.com

**Icare USA, Inc.**

4700 Falls of Neuse Rd. Ste 245

Raleigh, NC. 27609

Ph. +1 888.422.7313

Fax +1 877.477.5485

infoUSA@icare-world.com

[www.icare-world.com](http://www.icare-world.com)

**icare**

iCare is a registered trademark of Icare Finland oy, Centervue S.p.A, Icare Finland Oy, and Icare USA Inc. are parts of Revenio Group and represent the brand iCare. Not all products, services or offers referenced in this brochure are approved or offered in every market and approved labeling and instructions may vary from one country to another. Product specifications are subject to change in design and scope of delivery and as a result of ongoing technical developments.