



Global Version

Continuous-Wave Fiber Laser

User Guide

RFL-C12000S-CE

Wuhan Raycus Fiber Laser Technologies Co., Ltd

TABLE OF CONTENTS

1 Safety Information.....	4
1.1 Symbols Used in this User Guide	4
1.2 Laser Classification	4
1.3 Safety Labels	4
1.4 Optical Safety	6
1.5 Electrical Safety	6
1.6 Other Safety Rules	6
2 Product Description.....	7
2.1 Features	7
2.2 Package Contents	7
2.3 Unpacking and Inspection	7
2.4 Operation Environment	8
2.5 Precautions for Use	9
2.6 Specifications	10
3 Installation.....	12
3.1 Dimensions	12
3.2 Output Head and Installation	13
3.3 Cooling Requirements	13
3.4 Installation Procedure	16
4 Using the Product	18
4.1 Front Panel	18
4.2 Rear Panel	19
4.3 Power Connection	20
4.4 Interface Definitions	20
4.5 Steps of Installation	25
4.6 Steps of Starting	25
4.7 Functions of the clientware	25
4.8 Control Modes	35
4.9 Guide laser control	38
4.10 The Programming Mode (Waveform Editing)	39
4.11 Laser timing diagram	47
4.12 Modulation signal requirements	47
4.13 Steps of shutting down	47
5 Alarms and Solutions.....	47
5.1 Alarms Display	47
5.2 Alarm solutions	48
6 Warranty, Return and Maintenance.....	50
6.1 General Warranty	50
6.2 Limitations of Warranty	50
6.3 Service and Repair	50

1 Safety Information

Thank you for choosing Raycus fiber laser. This User Guide provides important safety, operation, warranty and other information. Please read it carefully before you use this product. In order to ensure safe operation and optimal performance of the product, please follow the warnings, cautions, operating procedures and other instructions accordingly.

1.1 Symbols Used in this User Guide

	WARNING: Refers to a potential hazard that may lead to a personal injury or death.
---	---

	CAUTION: Refers to potential a hazard that may lead to general personal injury or product damage.
---	--

1.2 Laser Classification

This series of lasers are classified as a high power Class 4 laser instrument according to the European Community standards EN 60825- 1, clause 9. This product emits invisible laser radiation at or around a wavelength of 1080 nm, and the total power radiated from the laser is greater than 12000W (depending on model). Direct or indirect exposure of this level of light intensity may cause damage to the eyes or skin. Despite the radiation being invisible, the beam may cause irreversible damage to the retina and/or cornea. Appropriate and approved laser safety eyewear must be worn all the time while the laser is operating.

	WARNING: You must use appropriate laser safety eyewear when this device is operating. The laser safety eyewear is selected according to the range of wavelengths emitted from this product. The end user must ensure that the laser safety eyewear being used protects against light emitted by the device over its entire range of wavelengths. Please verify that the personal protective equipment (e.g. enclosures, viewing windows or viewports, eyewear, etc.) being utilized is adequate for the output power and wavelength ranges listed on the product.
---	--

1.3 Safety Labels

The position of the safety labels on products varies depending on the model of the continuous-wave fiber laser, as shown in Figure 1:

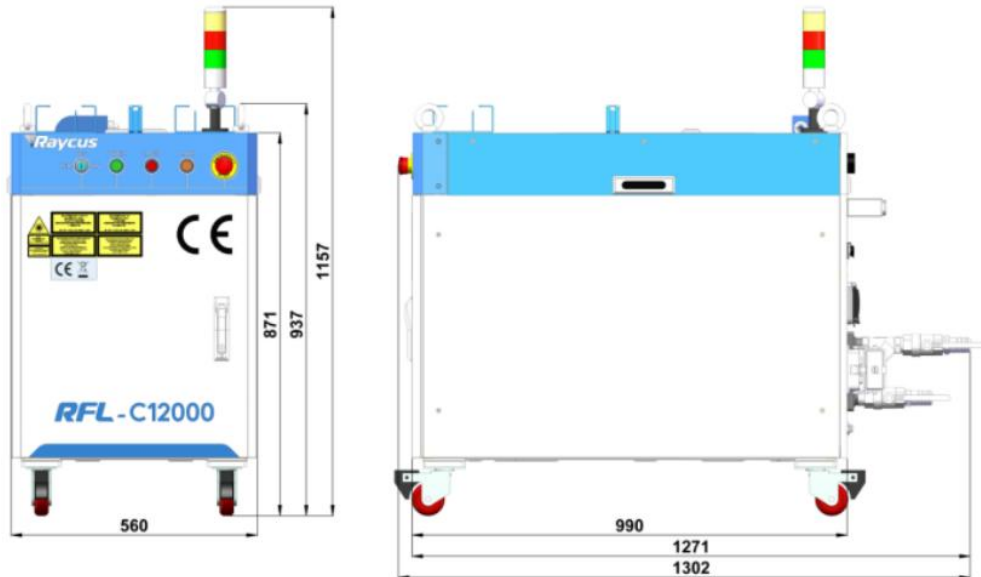











Figure 1: Safety Label Locations of RFL-C12000S-CE

These safety labels include warning labels, apertures through which laser radiation is emitted and labels of certification and identification, etc. Specifications of these labels are as follows:

Table 1: Specifications of Safety Labels

<div style="text-align: center;">  <p>English label</p>  <p>Chinese label</p> </div>	<div style="text-align: center;">  <p>English label(Take 500W for example)</p>  <p>English label (Take 500W for example)</p> </div>	<div style="text-align: center;">  <p>English label</p>  <p>Chinese label</p> </div>
<p>1.Aperture Label</p>	<p>2.Class 4 Laser Product</p>	<p>3.Class 2M Laser Product Label for Guide Laser</p>
<div style="text-align: center;">  </div>	<div style="text-align: center;">  </div>	<div style="text-align: center;">  </div>
<p>4. CE Compliance</p>	<p>5. Identification Plate</p>	<p>6.Laser Radiation Hazard Label</p>

		
7.Electrical Hazard		

1.4 Optical Safety

Any dust on the end of the collimator assembly can burn the lens and damage the laser.

	<p>CAUTION: If the output of the device is delivered through a lens with an anti-reflection coating, make sure that the lens is of good quality and clean.</p>
---	---

1.5 Electrical Safety

- a) Make sure your product is grounded through the PE line of the AC power cord. The grounding must be firm and reliable.

	<p>WARNING: Any interruption from the protective earth will electrify the enclosure, which may result in personal injury.</p>
---	--

- b) Make sure that the correct voltage of the AC power source is used.

	<p>CAUTION: Failure to connect the correct voltage could damage the product.</p>
---	---

1.6 Other Safety Rules

- a) Never look directly into the laser output port when power is supplied to the laser.
- b) Avoid using the laser in a dim or darkened environment.
- c) If this device is used in a manner not specified in this document, the protection provided by the device may be impaired and the warranty will be voided.
- d) There are no operator serviceable parts inside, and all maintenance must be performed in Raycus or by qualified Raycus personnel. Do not try to remove covers, or electrical shock may be caused, and warranty will be void.

2 Product Description

2.1 Features

Compared with traditional lasers, Raycus CW fiber laser has higher efficiency electric-optical conversion, lower power consumption and excellent beam quality. The fiber laser is compact and ready to use. It can be used as a stand-alone unit or easily inserted into user's apparatus.

Main Features:

- a) Excellent beam quality
- b) High quality fiber output
- c) High Power Stability
- d) Continuously tunable output power, quick switching response
- e) Slow rise and slow fall, Waveform editing
- f) Maintenance free operation
- g) High wall plug efficiency

Applications:

- a) Cutting, Welding
- b) 3D Printing
- c) Scientific research

2.2 Package Contents

Please refer to the packing list accompanying the shipment to check actual items included.

2.3 Unpacking and Inspection

Raycus CW fiber laser is shipped in a package designed to provide maximum protection. Upon delivery, please inspect all packaging for evidence of mishandling or damage. If you find any evidence of mishandling, please save the damaged material and contact the shipping agent and Raycus immediately.

Remove all the contents from the packing case. Take extra care when removing the unit out of the packing case to ensure that the fiber optic cable is not twisted, hauled or damaged. A comprehensive packing list is included with the system documentation. Check all items against the list and contact Raycus immediately if there is any missing item or evident damage to the unit. DO NOT attempt to install or operate the laser, if there is any evident or suspected damage to the unit.

It is recommended to keep the packing materials, as they will be necessary if you ever need to ship the unit back for service at a later date.



CAUTION:The fiber optic cable and output head is precise optic instrument, any vibration or impact to the output head, and twist or excessive bend to the cable will damage the instrument.

2.4 Operation Environment

The basic operation conditions are listed in the table below:

Table 2 Basic Operation Conditions for the Laser

Model	RFL-C12000S-CE
Supply Voltage(V)	380± 15%Vac , 50/60Hz
Supply Capacity(kW)	>33
Installation Requirements	Install on flat surface, no vibration or impact
Ambient Temperature(°C)	10~40
Relative Humidity(%)	30~70

Warning:

- a) Ensure reliable grounded before using the laser.
- b) The laser output is connected to the output cable. Please check the laser output carefully to prevent dust or other contamination. Use special paper when cleaning the laser output lens.
- c) If the laser is used in accordance without the method specified in this manual, the laser may be in abnormal working state and cause damage.
- d) It is strictly forbidden to install the laser output when the laser is in operation.
- e) Do not look directly into the laser output. Be sure to wear protective glasses when operating the laser.



- ◆ Do not expose this product to high humidity (>95%)
- ◆ Do not let this product work below the ambient dew point temperature.(see Table 3)

Table 3 TheConstant Dew Point Table

AMBIENT DEW POINT									
Room Temperature(C)	Maximum Relative humidity								
	20%	30%	40%	50%	60%	70%	80%	90%	95%
20	-3.5	2	6	9	12	14.5	16.5	18	19
25	0.5	6	10.5	14	16.5	19	21	23	24
30	4.6	10.5	15	18.5	21.5	24	26	28	29
35	8.5	15	19.5	23	26	28.5	31	33	34
40	13	20	24	27.5	31	33.5	36	38	39
Laser operating temperature range									

	<ul style="list-style-type: none"> ◆ Green area: The dew point temperature is 22Cthat is lower than the laser cooling water temperature, which can be used safely; ◆ Red area: If the dew point temperature is higher than 22C and exceeds the laser cooling water temperature by 22C, there must bedew condensation, and measures must be taken. <p>Measure 1: Connecting clean and dry air from CDA port to reduce relative humidity, works for 10- 15 minutes in standby mode;</p> <p>Measure 2: Installing cabinet air conditioner to reduce ambient temperature.</p>
---	--

2.5 Precautions for Use

- a) Before supplying the power to the device, make sure that the correct voltage of the AC power source is used. Failure to connect power source correctly will damage the device.
- b) Failure to follow the instructions may cause malfunction and damage to the device, such damage is not covered by warranty.
- c) It is very important to ensure the cleanness of the calibrated laser output head, otherwise it will cause irreparable damage to the laser.
- d) Please inspect the output head carefully for dust or other contaminations. Use appropriate lens paper to clean it if necessary. Do not touch the output lens at any time;

as well as remember to cap the output head when it is not in use, and make sure the cap is clean.

- e) Failure to follow the specified instructions may result in the loss of laser power, and such loss will not be covered by the warranty.

2.6 Specifications

Table 4 Specifications

Number	Index	Condition	Minimum value	Standard value	Maximum value	Unit
Fiber technical index						
1	Operation Mode	Nominal Output Power	Continuous Wave / Modulated			
2	Nominal Output Power	Water Temperature 22± 1C	12000	12100	12200	W
3	Emission Power Range	Nominal Output Power	10		100	%
4	Emission Wavelength	Nominal Output Power	1075	1080	1085	nm
5	3dB Spectral width	Nominal Output Power		4	6	nm
6	Long-term power stability	Nominal Output Power			± 1.5	%
7	Modulation Frequency	Nominal Output Power	1		5000	Hz
8	Duty ratio Range	Nominal Output Power	1		100	%
9	Red Guide Laser Power	/	0.5		1	mW

QBH Optical index of output optical cable						
10	Fiber Core Diameter	/		50		μm
		/		100		μm
11	Beam Quality (BPP)	75μm Fiber Core	2		3	mm×mrad
		100μm Fiber Core	3		4	mm×mrad
12	Fiber NA	75/ 100μm Fiber Core		0.2		/
13	Fiber Delivery Cable Length	75μm Fiber Core		20	20	m
		100μm Fiber Core		30	30	m
Other technical indicators						
14	Operating Voltage	Nominal Output Power	Three-phase four-wire system 50/60Hz , 380± 15%			VAC
15	Way to Control	/	AD/RS-232/Ethernet			
16	Power Consumption	Nominal Output Power	28	30	32	kW
17	Water flow requirement	Nominal Output Power		100		L/min
18	Water Temperature requirement	Nominal Output Power	21	22	23	C
19	Dimension	W×D×H	560×990×1100			mm
20	Weight			260	280	kg
21	Operating Ambient Temperature	/	10~40			C
22	Operating Ambient Humidity	/	30~90			%
23	Storage Temperature	/	- 10~60			C

3 Installation

3.1 Dimensions

Figure 2 shows dimensions of RFL-C12000S-CE.

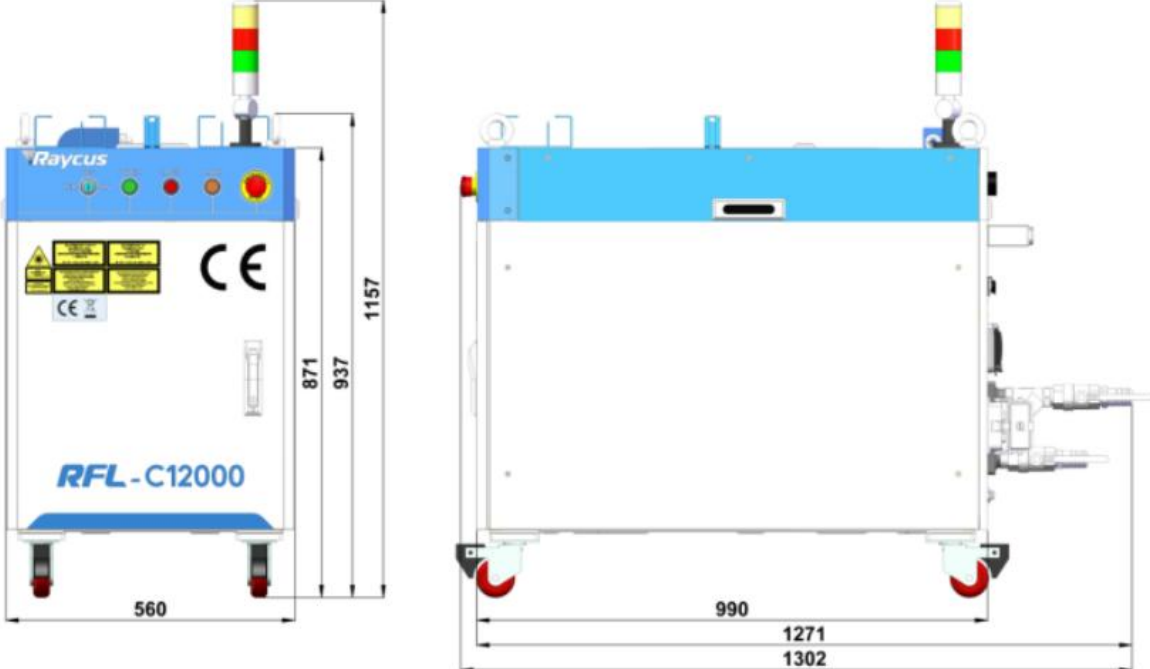

Figure 2a) Front and Rear panel view(unit: mm)

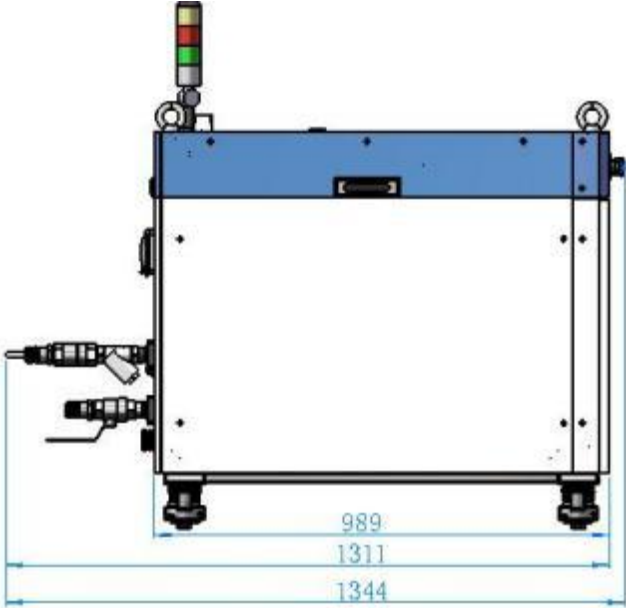

Figure 2b) Top and Side view(unit: mm)

3.2 Output Head and Installation

The laser output head of RFL-C12000S-CE is the standard QD interface. The specific appearance and dimensions are shown in Figure 3 above. Compared with other models, the size of the protective end cap of the fiber delivery cable of this model is lengthened.

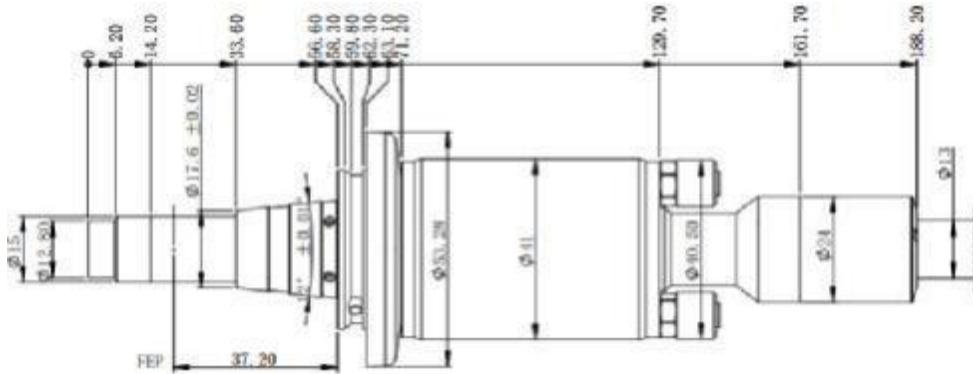

Figure 3 Dimensions of the QD fiber delivery cable (unit:mm)

	<p>CAUTIONS:</p> <ul style="list-style-type: none"> ◆ Inspect the output lens before installing the output head to the processing head. Clean the output lens if necessary. ◆ It is strictly prohibited to disassemble the output head by personnel not approved by Raycus, or the warranty is void.
--	---

3.3 Cooling Requirements

Table 5 Cooling Requirements

Model	RFL-C12000S-CE
Cooling Capability(W)	>30000
Minimum Flow(L/min)	80
Maximum Pressure(Bar)	7
Pipe Inner Diameter(mm)	32
Water temperature of cooling system(C)	22± 1C

a) The water temperature setting of cooling system:

$$22 \pm 1C$$

b) Cooling system filter access requirements:

When the water quality of the laser cooling system is poor (more impurities), the laser water path is easy to be blocked, causing flow alarm or high temperature alarm, resulting in laser shutdown. In serious cases, the laser waterway will be scrapped. Therefore, RFL-C12000S-CE laser is equipped with water inlet filter module, as shown in Figure 4.



Figure 4 The inlet filter module

When the laser is installed and used, firstly connecting the water inlet filter module with the water outlet of the customer's on-site cooling water system according to the water flow direction indicated by the arrow in Figure 4, and then connect the water inlet filter module with the water inlet of the RFL-C12000S-CE laser, as shown in Figure 5.

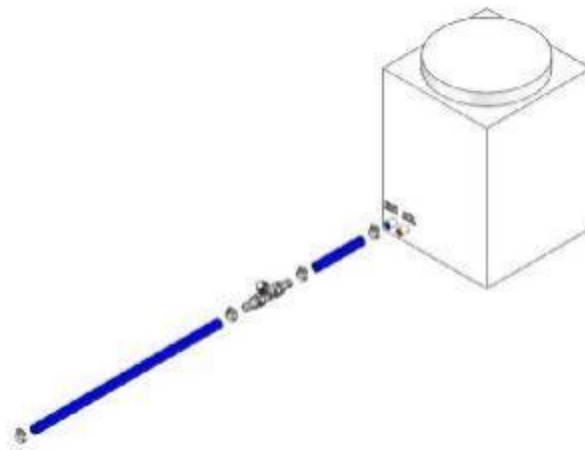



Figure 5 The water inlet filtration module is connected to the water cooling system

When the laser is in use, cleaning the Y-type filter of the inlet water filter module periodically according to the water quality of the cooling water system (opening the nut cover of the Y-type filter, taking out the filter screen, cleaning it, reinstall it, and tightening the nut cover), it is recommended that the cleaning frequency be no less than once a week.

c) Cooling water requirements:



- 1) It is recommended to use purified water.
- 2) In order to prevent mould growing that may lead to pipe blockage, we recommend to add alcohol about 10% of the total volume.
- 3) If the product is used in an environment that ambient temperature is between - 10C and 0C, we recommend to use 30% alcohol, and replace it every two months.

- 4) If the product is used in an environment that ambient temperature is below - 10 C, please to use dual-system chillers (with heating function) and ensure uninterrupted operation of the cooling system.
- d) Requirements for output cable cooling system:
- 1) Rate of liquid flow: 1.7-2.0 L/min;
 - 2) Pressure of liquid flow: < 0.6 MPa at the inflow;
 - 3) Type of liquid exchangejunction: SMC MS-5H-6;
 - 4) Type of tube: outer diameter6; inner diameter4;
 - 5) Direction of cooling liquid: unidirectional; connect the tube with the water-pipe strictly according to direction shown on the layer of the tube;
 - 6) Type of liquid: de-ionized water, condensed water, pure water;
 - 7) PH value of liquid: 5.5-9;
 - 8) Filter is needed for the cooling system, and the size of the solid residual practical should be within 100um;
 - 9) Maximum temperature of liquid: 45C;
 - 10) Minimum temperature of liquid: greater than the saturated dew-point 5C;
 - 11) Additive to the liquid: satisfies the requirements of PH value and size of solid residual practical as above;
 - 12) Radius of the bending of the armored pipe: off-work state (i.e. transportation and reservation): minimum radius of bending ≥ 20 cm; in-work state: minimum radius of bending ≥ 30 cm;
 - 13) Long-term vibration < 2 G; Impact action < 10 G.
- e) Other requirements for chiller:
- 1) When starting the cooling system for the first time, check the entire water system and the joint for water leakage. The external water pipe must be installed and connected according to the inlet (IN) and outlet (OUT) by the laser. Otherwise, the laser may not work properly.
 - 2) If you will not use the laser for a long time, water must be emptied from the product, and then both the inlet and outlet must be blocked with the nuts we provide. Failure to do so may lead to permanent equipment damage.

	<p>CAUTION: Please set the water temperature in strictly accordance with the requirements above. Too low temperature may lead to condensation on the laser module and the output cable. This can cause serious damage to the equipment.</p> <p>CAUTION: Please clean the water inlet filter module in time. If the water inlet filter module is blocked, the laser flow alarm or high temperature alarm will be triggered.</p>
	<p>CAUTION: Make sure that the water temperature reaches the set point and the cooling system is working well before you start the laser.</p> <p>〔summer: 22± 1C; winter : 22± 1C〕</p>

3.4 Installation Procedure

- a) Place the product in a still and stable position.
- b) Check if the power supply has the correct voltage (See Table 4 for the laser model and corresponding input voltage), and the earth line is connected, make sure it is firm and reliable.
- c) Connect the power cable and control cable to the product when power supply is OFF.
- d) Insert the water pipes into the inlet and outlet.
- e) Check the output head and clean it if necessary. This procedure must be performed by personnel of Raycus or authorized by Raycus. Make sure the environment is clean, or the output cable may be contaminated.
- f) Prevent the delivery cable from treading, pinching or excessive bending during installation.
- g) During the installation and disassembly process, please take care to handle the laser output head gently, avoiding any shock.
- h) In the installation of laser output cable and output head process, please make sure that the surrounding environment is clean, otherwise it may pollute the output head (do not use fans, which actually may bring more dust).
- i) The minimum bending radius of the output fiber cable of the laser should not be less than 20 cm under the non-working conditions, and the minimum bending radius should not be less than 30 cm when the laser is working.

	<p>CAUTION:</p> <ul style="list-style-type: none">◆ All the cables can only be connected when power supply is OFF. Hot plug may damage the laser.
	<p>CAUTION:</p> <ul style="list-style-type: none">◆ The laser output optical cable should be kept as natural as possible and not be distorted.◆ The too small bending radius of the output fiber cable will damage the laser.
	<p>CAUTION:</p> <ul style="list-style-type: none">◆ Make sure the aperture and the cavity of the processing head is clean.◆ Keep the protective cap properly, prevent it from contamination; Or the aperture will be contaminated when capped.

4 Using the Product



Please use the correct the latest PC software and the relevant manual.

4.1 Front Panel

Figure 6 shows the front panel of RFL-C12000S-CE:



Figure 6 Front Panel of RFL-C12000S-CE

- a) **REM/OFF/ON:** Key switch, the control system power switch of the laser. Insert the key; either turning the key clockwise to the 'ON' position or counterclockwise to 'REM' position (short-connect the Pin 8 and Pin 9 of Table 7) will power on the laser control system. Then the laser will enter a control mode depending on your previous setup on the 'CTRL-INTERFACE'. You can refer to **【4.8 Control Mode】** for more details.
- b) **POWER:** The control system power, GREEN, indicates that the control system is switched on.
- c) **LASER:** Laser emission indicator, RED, illuminates when laser emission is on.
- d) **ALARM:** Alarm indicator, YELLOW, indicates an error condition.
- e) **EMERGENCY STOP:** Press it down to stop the laser immediately. When the button is in the 'down' position, turn it clockwise to release, but the laser cannot start before it's powered on with key switch for a second time.

4.2 Rear Panel

Figure 7 shows the rear panel of RFL-C12000S-CE:

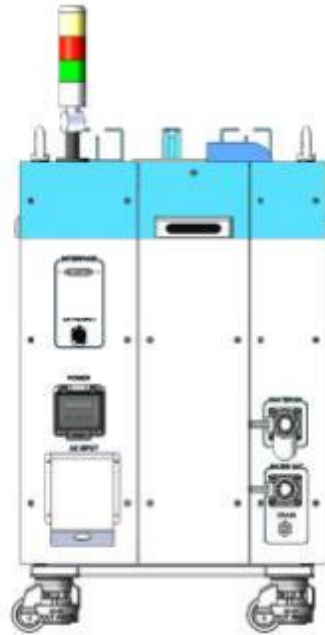

Figure 7 Rear Panel of RFL-C12000S-CE

- a) **AC INPUT:** The socket for supply source input that can only be mated with the plug on the power cord we provided (See Table 4 product technical parameters for laser model and corresponding input voltage). Please use only the enclosed power cord provided by Raycus.
- b) **POWER:** Air switch to control the switching of AC.
- c) **CTRL-INTERFACE:** Control interface, CTRL-INTERFACE interface (DB-25), multi-function multiplex interface, users can set control mode, input analog voltage signal, modulate 24V signal, and it is also an alarm signal output interface.
- d) **WATER:** Pipe connectors, the inlet and outlet for cooling water to flow in and return. (See Table 5 for the laser model and corresponding water pipe size for cooling system requirements)
- e) **ETHERNET:** Ethernet interface. It can provide remote control and storage alarm information for the laser.
- f) **DRAIN :** The built-in dehumidifier has a drainage interface, the built-in dehumidifier works to condense the water and moisture inside the cabinet into water droplets for discharge.

4.3 Power Connection



	<p>CAUTION: Before connecting the product to AC supply source, you must check for sure that the AC supply you will apply is in accordance with the specifications provided in Table 2 or 4.</p>
---	--

Table 6 Power Connection Requirements

Model	RFL-C12000S-CE
Supply Source	380± 15% V AC 50/60Hz
Power Cord	
One End of Power Cord	<p>8 wires, each 2 wires are multiplexed, and the diameter of single wire is 6mm², Four wires labeled L1 , L2 , L3 and PE</p>
Sign Description	<p>L1 , L2 , L3-> Phase Line, PE-> Protective Earth</p>
Note	<p>One end of the power cord is a plug, insert it into the socket 'AC INPUT' on the rear panel. Notice that the plug is wrong-side preventing. After inserting it, lock it with the lever.</p>

4.4 Interface Definitions

4.4.1 CTRL-INTERFACE Definitions

The CTRL-INTERFACE(DB-25) is for laser control, the designation and definition is below:

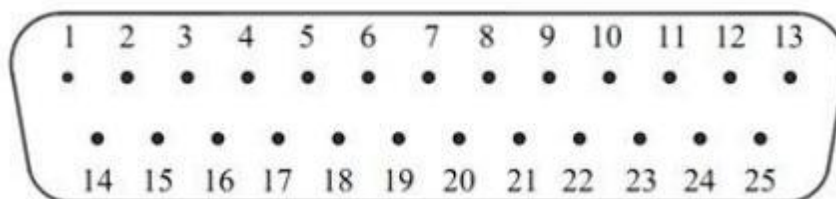

Figure 8 Diagram of CTRL-INTERFACE

Table 7 Definitions of 24 pin Ctrl Interface

Pin No.	Name	LineMark	Type	Level	Drive Current	Typical Response Time	Description
1	Interlock2A	ITL-2A	Contact Closure Input	24Vdc	<1A	<500ms	“EN954- 1” or”ISO13849- 1 Cat.3PLD”. Passive contact, not connected to external voltage or grounding.
2	Interlock 1A	ITL- 1A					
3	Interlock 1B	ITL- 1B					
4	Interlock2B	ITL-2B					
5	RS232Tx	TX	---	---	---	120ms	Transmit Data
6	RS232Rx	RX	---	---	---		Receive Data
7	RS232Com	GND	Return	---	---		RS-232 Return
8	Remote Key Switch	RPA	Contact Closure Input	24Vdc	---	20s	Activates the internal control system power supply in REM mode. Passive contact, not connected to external voltage or grounding.
9		RPB					
10	Remote Start Button	START-A	Instantaneous Contact Closure Input	24Vdc	---	1s	In REM mode, start the laser main power supply. Passive contact, not connected to external voltage or grounding.
11		START-B					
12	Analog Input to Control Current	1- 10V	Analog Input	1- 10 Vdc	1 mA	100μs	Analog Input 1- 10 VDC= 10 – 100% Setpoint
13	Analog Output Power Monitor	AOUT	Analog Output	0-8.0 Vdc	11mA	20μs	Analog Output 0-8VDC (Refer to factory inspection report for details)
14	Isolated Analog Com	GND1	Return	---	---	---	Return for signals on pins 12, 13
15	Modulation+	MOD+	Digital Input	5-24Vdc	6 mA	20μs	5 -24 VDC Input

16	Modulation-	MOD-	Return	---	---	---	Return for signal on pin 15
17	Guided Laser Control	RED-LASER	Digital Input	5-24Vdc	6 mA	120ms	Positive edge activates emission in REM mode
18	Emission Enable	LAS-C	Digital Input	5-24VdC	6 mA	120ms	Positive edge activates emission in REM mode
19	READY	READY	Digital output	24VdC	100mA	120ms	High=Laser is ready
20	System Common	GND2	Return	---	---	---	Return for pin 17 、 18、 19 、 21 、 22 、 23 、 24
21	Error RESET	RESET	Digital Input	5-24VdC	6 mA	120ms	Rising edge reset (the resettable alarm)
22	Laser Alarm	S-ERR	Digital output	24VdC	100mA	120ms	High=Alarm status
23	Power started	POWER	Digital output	24VdC	100mA	120ms	High= The main power supply is started
24	Laser emission	LASER	Digital output	24VdC	100mA	100ms	High=Laser is emission



◆ Caution: Please check the control voltage level and ensure that the level is in accordance with the requirements. Over voltage and voltage ripple may damage the product.

The Service Security Interface is pin 2-3 and pin 1-4 of CTRL-INTERFACE. If the pin 2-3 and pin 1-4 are disconnected, the laser will immediately stop emitting light, and the laser Ready signal output will change to low level. Be sure to short-circuit pin 2-3 and pin 1-4 before using the laser. If it is not short-circuited, the laser will display InterLock alarm after power-on.



◆ Interlock interface must not be connected to active signal, otherwise it will cause interface damage and laser alarm.

4.4.2 TCP/IP Interface Configuration

The default IP address of this product is 192.168.0.10, only supporting UDP communication. The laser listens for connection on port is 8098, and the command must be sent in a single data string.

Table 8 The pin definitions of Ethernet interface

PIN	FUNCTION	DESCRIPTION
1	TX+	TRANSMIT+
2	TX-	TRANSMIT-
3	RX+	RECEIVE+
4	N/C	NONE
5	N/C	NONE
6	RX-	RECEIVE-
7	N/C	NONE
8	N/C	NONE

For better communication stability, recommend to use this interface first.

Table 9 The default IP address of the laser

The default IP address of the laser	
IP address	192.168.0.10
Subnet mask	255.255.255.0

Steps of Ethernet connection:

- a) **Open “Local Connection” on your computer, and then click “property” ;**
- b) Select "Internet Protocol Version 4 (TCP/IP 4);
- c) **Click the “Property” ;**
- d) **Check “Use the following IP address:” to manually assign an IP address;**
- e) Manually assign an IP address is 192.168.0. x (x cannot be 10, because 192.168.0.10 has been assigned to the laser) , and assign a subnet mask address. The default is 255.255.255.0;
- f) Click the "OK" button to confirm the settings and exit. The IP address is different from the default gateway, see Figure 9.

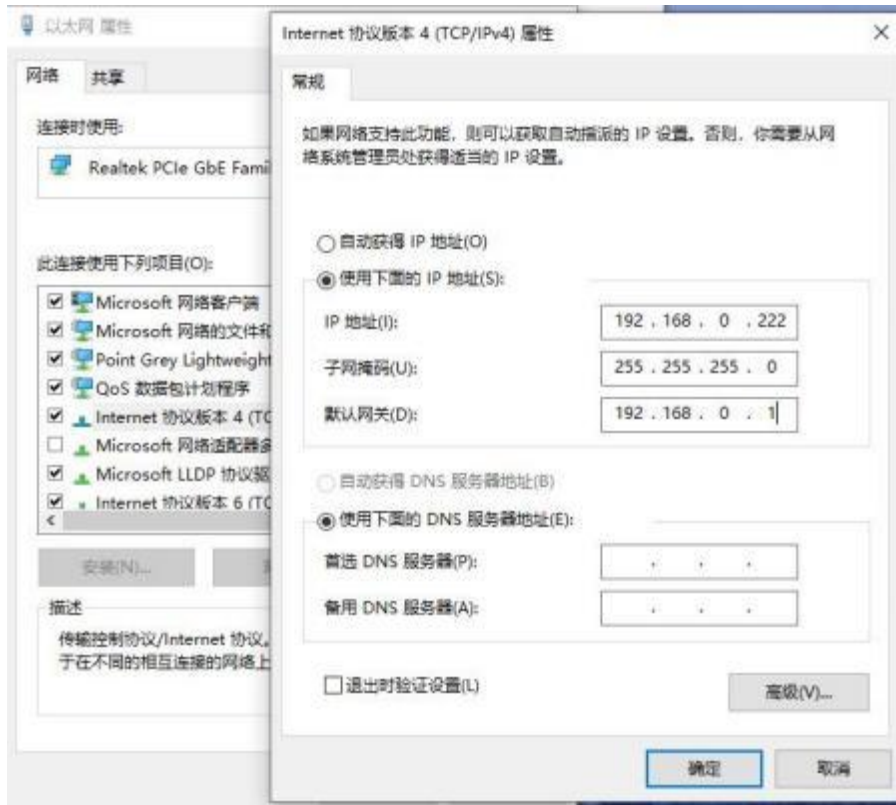

Figure 9 Steps of Ethernet Connection

When the IP setting is completed, turn on the host computer, and the connection status in the corresponding text box on the host computer interface displays: connected, indicating that the microcontroller program is running normally and the communication connection is normal. The display interface is shown in Figure 10 below.



Figure 10 The main interface is displayed when the communication connection is normal

4.5 Steps of Installation

- a) Carefully takeout the laser from the box and move it to the installing position and then lock the casters;
- b) Remove the output cable protective cap and check the output lens for dust with strong light and clean it ifnecessary, then cover the output cable protective cap;
- c) Install the output cable on the processing equipment according to the actual situation (install the output head cooling water pipe at the same time), pay attention to the output cable and head,then remove the protective cap andconfirm that the output lens is clean and install the output head;
- d) Connect cooling water pipe;
- e) Connect the control line and power according to the control mode.

4.6 Steps of Starting

Make sure the air switch is OFF and the emergency stop button (STOP) on the front panel of the laser has been pressed down;

- a) Make sure that the pins the 24-pin are closed;
- b) Turn on the chiller and check leakage. If there is no water leakage, turn off the chiller and wait for the laser to turn on;
- c) Turn on the air switch and release the emergency stop switch;
- d) Let the chiller work;
- e) Turn on the key switch and start the laser.

4.7 Functions of the clientware

The RFL-C12000S-CE clientware communicates with the main control board through UDP when it is working. Through the background program running in the software and the human-computer interaction operation, the laser parameters are read and set and the control functions are realized. The interface displayed by the software is divided according to functional categories, including control, alarm, about, language selection, authorization, working mode selection and other pages.



Figure 11 Theclientware interface

4.7.1 The control interface

The control interface is the content displayed on the first page after opening the clientware, including the user's most commonly used status signal, laser parameter setting and laser control related functions.

Control the main power: turn on or off the main power. After turning on or off the main power, the software will change the status of the main power.

Control abnormal laser reset: Click the reset button to run the abnormal laser reset command.

Guide laser: the guide laser is turned on or off in the internal control state of guide laser. After the guide laser is turned on or off, there will be changes in the guide laser state on the software.

Guide laser external control: turn on the guide laser external control or turn off the guide laser external control. After turning on and turn off the guide laser external control, there will be changes of the guide laser external control state in the software.If the current red external control state, then disable the red control button.

Read and set the parameters of rise time and fall time: The rise time and fall time can be set separately and must be an integer ranging from 0 to 61000.

Read and Set Program Number: The program number is displayed in the drop-down list box. When you click the drop-down list box, the program number saved on the main control board is loaded. Only the valid program number is displayed. The default value is "Not set", corresponding to the program number "0". When you click Read, the current program number is read from the main control board. If the read program number is "0" and "unset" is displayed, otherwise, the read program number is displayed. When you click "Set", if "Not set" is selected, the program number is set to "0", indicating that the program mode is not currently used; otherwise, the program number is set to the currently selected program number. When the software is started, the program number set on the current main control board is automatically read and displayed.

Control laser parameters: Optical output parameters include power, frequency, pulse width, and duty cycle. The communication between the software and the main control board requires only power, frequency, and pulsewidth. The duty cycle can be calculated from the pulse width and frequency, and the pulse width can also be calculated from the duty cycle and frequency. During the software operation, the frequency and duty cycle will be changed synchronously with the pulse width, and the duty cycle will also be changed synchronously with the frequency and duty cycle. The output power can be an integer in the range of [0,100]. The frequency can be set to a decimal in the range of [0,1000]. The duty cycle can be set to a decimal in the range of [0,100].

Control light emission mode: light emission related modes include AD mode, external enable, external modulation mode, and internal modulation mode. You can individually control the opening and closing of each mode, and display the current status of each mode. After the AD mode is turned on, the optical power is controlled by an external signal, and the power setting function of the software should be set to a disabled state. When the external modulation mode is turned on, the frequency, pulse width and duty cycle are controlled by the external modulation signal, and the function of the software to set the frequency, pulse width and duty cycle should be set to the disabled state.

Control the light: control to turn on or off the laser emission or laser enable. Only when the laser has a ready signal, can it be controlled normally, otherwise the buttons for turning on and off the laser are set to the disabled state. When the external control light enable is turned off, and the external modulation mode or internal modulation mode is turned on, the "laser enable" is displayed, otherwise, the "laser emission" is displayed.

Status display: Including emergency stop, laser enable, Interlock logic normal, Interlock1 closed, Interlock2 closed, power ramp up and down, program mode, program execution, program

execution completed, program execution abnormal and other most commonly used laser states, and machine Internal ambient temperature, internal ambient humidity, dew point, external 0- 10V, light output frequency, light output duty cycle, light pulse width, laser water flow, output optical cable water flow and other data. These status and data refresh time intervals should not exceed 300ms.

Laser usage time display: including today's turn-on time, today's light-emitting time, cumulative turn-on time, and cumulative light-emitting time.

4.7.2 The alarm interface

All the alarm information of the current laser is displayed on the alarm interface, and the alarm information is updated in real time.



Figure 12 The alarm interface

4.7.3 About

The laser time, model, serial number, master control serial number, key version number and system information are displayed in the interface , when the about interface is opened, the upper computer software reads them from the master control module once.



Figure 13 The about interface

4.7.4 Language Selection

In the language selection interface, you can set the language used by the software. After selecting the language and clicking OK, you do not need to restart the software, automatically convert the content displayed in the software into a language, save the currently selected language to the configuration file, and display it according to the last set language when starting the software next time.

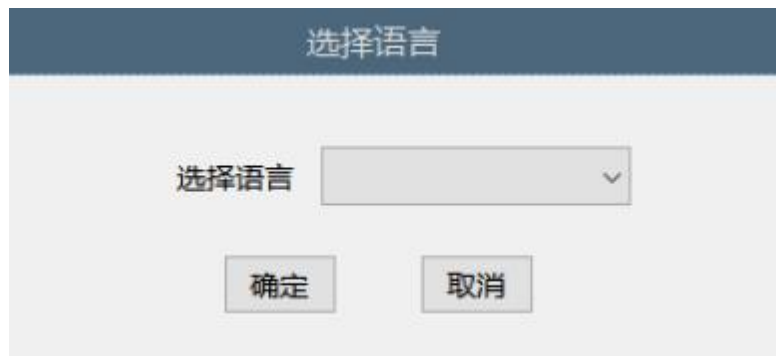

Figure 14 Language selection interface

4.7.5 Authorization

The authorization interface is used to control the limited time lock of the laser, when the authorization interface is opened, the machine code, laser lock time and lock time are loaded once, the laser lock time is Raycus's limited time lock for integrators, and the lock time is for the integrator to end customers. Limited time lock. In the authorization interface, only Raycus' authorization code can be set, and the function of calculating the authorization code is implemented in the server and has nothing to do with the host computer software. The authorization code used by the integrator can be generated in the authorization interface.



Figure 15 Authorization interface

4.7.6 The Mode Selection function

Select the operating mode of the software, including monitor mode, control mode, diagnostic mode, and debug mode.

Monitor mode: **The monitor mode is selected by default when the software is opened.** The most commonly used and concerned information is displayed on the software interface to avoid the interference of too much information to the user. The monitor mode can be used without password.

Control mode: The control mode adds the function of operational control interface on the basis of monitor mode. You need a password to enter the control mode. The initial password is 81338818 (the password can be changed).

Debug mode: On the basis of diagnostic mode, the parameter setting interface is added. Only Raycus debug engineers can enter the encryption mode.

Diagnostic mode: When a fault occurs in the laser and the user needs to diagnose the fault remotely or learn more about the status of the laser, the user can enter the diagnostic mode. The diagnostic mode adds the status and alarm information of **the master module, slave module, ACDC module and DCDC module** on the basis of the observation mode. You need a password to enter the diagnostic mode. The initial password is 81338818 (password can be changed).

4.7.7 Main control module

The main control module contains all the status, alarms and system parameters of the main control module. The status and alarm information are automatically refreshed. The refresh interval does not exceed 100ms. Only when the currently selected page is in the main control module, the upper computer software will automatically read it. Get and refresh status and alarm information, reduce communication frequency, and avoid occupying too many resources of the main control module.



Figure 16 Main control module status information interface



Figure 17 Alarm information interface of main control module

Connect the network through the system parameter interface of the main control module:

AP mode: the laser is a WiFi hotspot (the hotspot name and password can be configured). After the mobile phone is connected to the laser WiFi hotspot, you can use Ruike's mobile app to view the real-time status of the laser;

STA mode: the laser can automatically connect to the mobile phone hotspot or wireless router (the hotspot name and password can be configured). The laser establishes a connection to Ruike's cloud server through WiFi and sends real-time data, which can realize the functions of remote viewing and parameter setting.



Figure 18 Main control module system parameter interface

4.7.8 Slave control module

The slave control module contains all the status, alarm and optical status of the slave control module, 4 ACDC modules at most. The status and alarm information are automatically refreshed. The refresh interval does not exceed 100ms. The data of the slave control module needs to be forwarded by the master control module, so there is only the currently selected page. In the slave control module, the upper computer software will automatically read and refresh the status and alarm information, reduce the communication frequency, and avoid occupying too many resources of the master control module.



Figure 19 Slave control module status information interface

4.7.9 ACDC module

The ACDC module page contains the relevant status information of the ACDC module. It supports up to 12 ACDC modules. The refresh interval of the status information does not exceed 100ms. The data of the ACDC module needs to be forwarded by the main control module, so only the currently selected page is in the ACDC module. The upper computer software will automatically read and refresh the status information, reduce the communication frequency, and avoid occupying too many resources of the main control module.



Figure 20 ACDC module interface

4.8 Control Modes

The laser has two control modes, namely ON mode and REM mode. The user can select the mode to enter through the key ON the front panel. In ON mode, you can only set the power percentage, control the light output and light off. In REM mode, you can select AD mode, enable external control, internal modulation mode, and external modulation mode.

4.8.1 REM mode

AD mode

Table 10 AD mode setup

AD mode	Laser power
ON	12, 14 pin analog voltage 0~10V 0V——0% 10——100%
OFF	The host computer sets the power percentage

External enabled

Table 11 The setup of External enabled

External enabled	Laser enablement.	
ON	18, 21 foot rising edge of INTERFACE 24	
OFF	External modulation and internal modulation OFF	It is automatically enabled after the main power is powered on
	External modulation or internal modulation ON	The laser enable button in the upper computer software

4.8.2 The wiring diagram

4.8.2.1 Internal control in ON mode

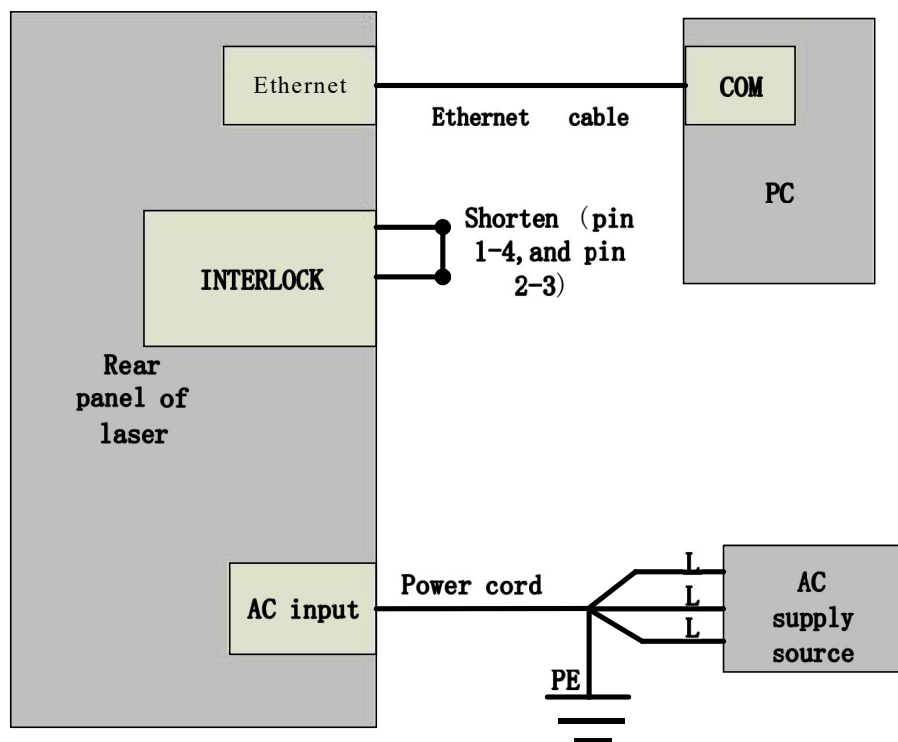

Figure 21 Internal control wiring diagram in key switch "ON" and clientware mode

Operation method:

- Spring the "ESTOP" knob on the front panel;
- Key turning "ON";
- Open the laser clientware;
- Click "the guide laser ON" button to view the guide laser;
- Disabling the AD mode\external enable\internal modulation mode and external modulation mode;
- Click ON "the main power ON";
- Waiting "Ready";
- Setting laser parameters;

- i) Click “laser ON” .

4.8.2.2 Internal/external modulation modes for power and communication in REM mode

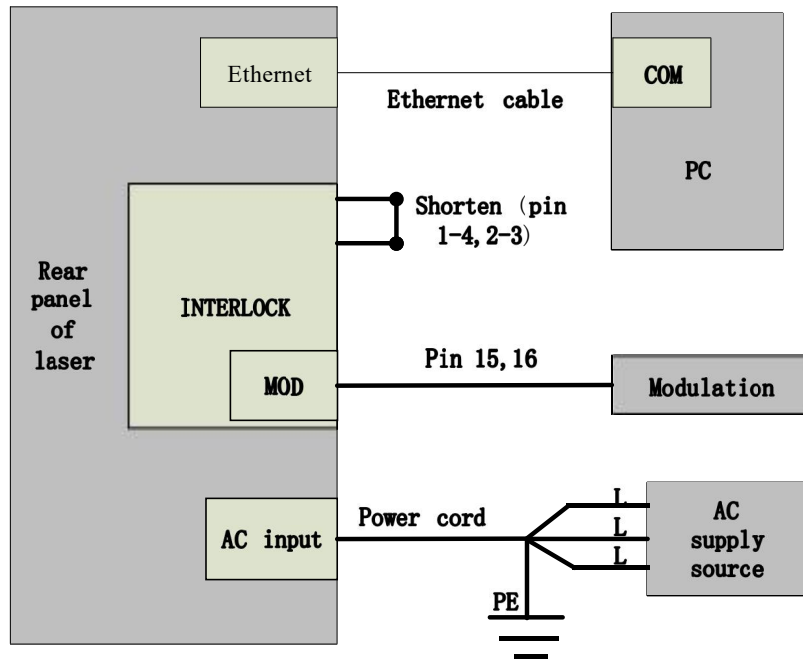

Figure 22 Wiring diagram of internal power control and external signal control in REM mode

Operation method:

- a) Spring the “ESTOP” knob on the front panel;
- b) Key turning “ON”;
- c) Shortconnect the 8 and 9 pins on the INTERFACE 24 pins (the control board is powered on);
- d) Open the laser clientware;
- e) Click “the guide laser ON” button to view the guide laser;
- f) Disabling the AD mode and the external enable, and opening the internal modulation mode or external modulation mode;
- g) Click ON “the main power ON”;
- h) Waiting “Ready”;
- i) Setting laser power parameters;
- j) When the duty cycle of the internal output frequency of the laser is set, set the output frequency/duty cycle/pulse width; (the output light is determined by the modulation signal of pin 15.16 and the output frequency and duty cycle set by the upper computer software); the internal output frequency of the laser is not required When the duty cycle is used, the default setting parameters are that the frequency is 100Hz and the duty cycle is 100%.
- k) Modulation signal (15, and 16-pin) provide a high level to turn on the laser.

4.8.2.3 The internal/external modulation mode of the analog in REM mode

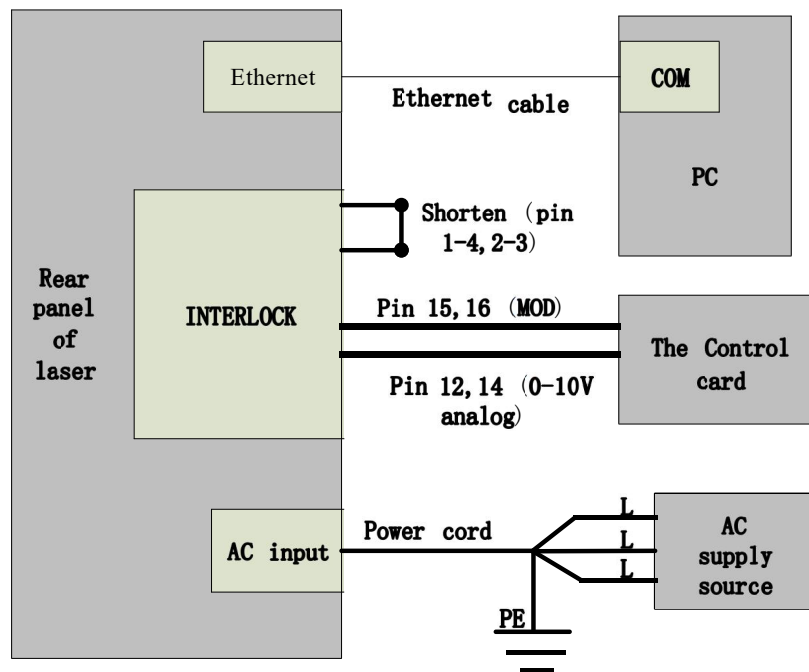

Figure 23 The power and laser are externally controlled wiring diagram in REM mode
Operation method:

- a) Spring the “ESTOP” knob on the front panel;
- b) Key turning “REM”;
- c) Shortconnect the 8 and 9 pins on the INTERFACE 24 pins (the control board is powered on);
- d) Open the laser clientware;
- e) Click “the guide laser ON” button to view the guide laser;
- f) Open the AD mode, turn off the external enable, and opening the internal modulation mode or external modulation mode;
- g) Click ON “the main power ON”;
- h) Waiting “Ready”;
- i) When the duty cycle of the internal output frequency of the laser is set, set the output frequency/duty cycle/pulse width; (the output light is determined by the modulation signal of pin 15.16 and the output frequency and duty cycle set by the host computer software); the internal output frequency of the laser is not required When the duty cycle is used, the default setting parameters are that the frequency is 100Hz and the duty cycle is 100%;
- j) Modulation analog quantities (12 and 14 pins)and signal (15, and 16-pin) turn on the laser.

4.9 Guide laser control

"Guide laser external control" can be selected in both ON and REM modes.

Table12 The setup of Guide laser external control

Guide laser external control	
ON	17 pin of INTERFACE Rising edge -- turns on guide laser; Falling edge -- turns on guide laser.
OFF	The clientware: Red ON -- turns ON guide laser; Red OFF -- Turns OFF guide laser.

4.10 The Programming Mode (Waveform Editing)

4.10.1 The Programming Mode enable method

In the Programming Mode, the laser has the functions of waveform editing, storing and calling. The Programming Mode can be used in the external modulation mode in both ON and REM modes.

Note: The Programming Mode function is used in REM mode, only the external modulation mode can be selected, and the internal modulation mode cannot be selected.

Table13 The setup of Programming Mode

Programming Mode	The laser is determined by the edit waveform	
Open: The current program number is not 0.	ON mode	Laser ON -- Start the program to execute Laser OFF -- Terminate the program
	External modulated modes in REM mode	INTERFACE24 pin 15, 16 pin voltage: Rising time -- Start the program to execute Falling time -- Terminates program running
Close: The current program number is 0	Do not execute a programming program	

When the current program number of the laser is not 0, the laser runs in Program Mode. Please use the software of Raycus to edit the waveform, and select the program number of pre-run. The output waveform of laser is determined by the edited waveform. Under the condition that all working conditions are met, the relation diagram of laser and programming waveform in programming mode is as follows:

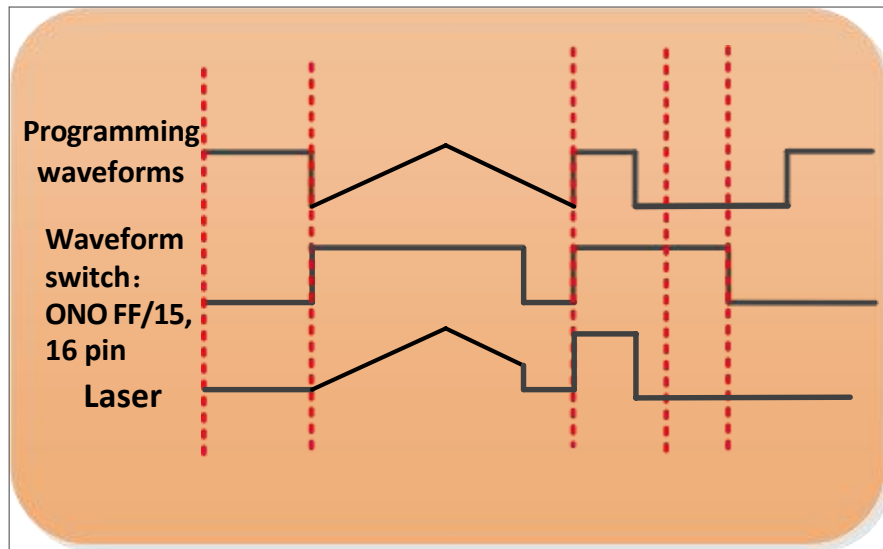

Figure 24 Relationship between laser and programming waveform in programming mode

4.10.2 The Programming Setup Interface (Waveform editing)

Select "Show programming mode" in "Mode Selection" on the clientware of the laser, as shown in Figure 25. The "Program Setting" option appears on the display interface of the clientware, as shown in Figure 26. Click "Program Setting" to enter the program setting interface, as shown in Figure 27.



Figure 25 Selecting "Show programming mode" in "Mode Selection"



Figure 26 Programming mode interface



Figure 27 Interface diagram of programming setting

4.10.3 Checking the number of saved waveforms



Figure 28 Checking the number of saved waveforms

Click the "Refresh List" button, and the software will automatically list the number of saved waveforms, green indicates that the bar has a program, and white indicates that the bar is empty.

4.10.4 Checking the waveforms



Figure 29 Check the waveforms

Select the waveform number, the program will automatically list the original waveform list.

4.10.5 Waveform Clearing



Figure 30 Clearing waveform

Click the program number to be cleared, click "clear", and then click "write laser", and the software will clear the waveform stored in the current laser.

4.10.6 Waveform editing

Select click the pre-edited waveform number:



Figure 31 Waveform editing

Select the command under command type, write the command and click



"Add".

Figure 32 Selecting the command

After editing all the commands, click "Write laser".



Figure 32 waveform writing success

Click "Refresh List" again, and the new waveform number will turn green, indicating that writing is successful:



Figure 34 Symbol for writing success



Figure35 Symbol for writing success

4.10.7 The Waveform Command Definition

Table 14 The waveform convenient command word detailed

Command code (1 byte)	Parameter 1 (2 bytes)	Parameter 2 (4 bytes)	Instructions
1 STOP	null	null	Program end command, which must be the last command of each program
2 SPT	0-65000 (ms)	0-65000(W)	It takes parameter 1 time to change the power to parameter 2
3 SPR	0-65000 (W/ms)	0-65000(W)	Change the power to parameter 2 at the rate of power change of parameter 1
4 WAIT	1 latency time	0-65000ms(int)	
5 GOTO	0-99 line	0- 10000	The number of times to jump to this line
6 EXTPower	1 0- 10V		

4.11 Modulation signal requirements

The modulation frequency range of the RFL-C12000S-CE laser is 1-5000Hz, and the minimum pulse width of the laser must be greater than or equal to 100μs, reference value of laser frequency and duty cycle setting is shown in Table 11.

4.12 Steps of shutting down

Please turn off the laser in the order below:

- a) Turn off the emission;
- b) Turn the key switch to the "OFF" position and release “START” button;
- c) Turn off the chiller;
- d) Disconnect the air switch;
- e) Cover the output head protection cap;

5 Alarms and Solutions

5.1 Alarms Display

Connect the computer and open the host computer software, after the laser and the client software establish normal communication. All alarm states of the laser can be displayed on the host computer software interface, as shown in Figure 36. When the internal temperature of the laser is abnormal, the power is abnormal, the scattered light is abnormal, the power supply is abnormal, the condensation is abnormal, the flow rate is abnormal, etc., the laser will alarm.

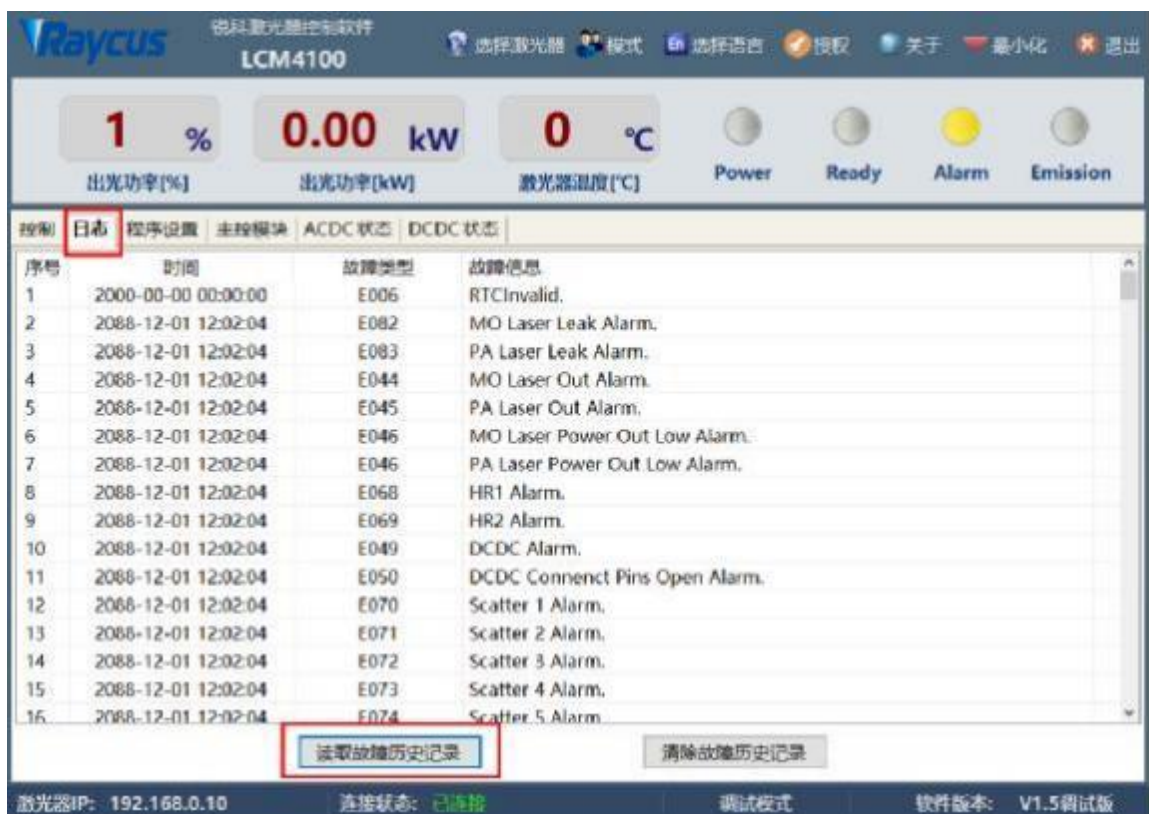

Figure36 Thehomepage of the clientware

If any alarm occurs (except for Interlock alarm) when the laser is running, the clientware will display the alarm that occurs, and the ALARM light (yellow) on the front panel of the laser will light up, the laser will stop emitting and lock.

When the Interlock is abnormal, the output of Ready signal is low, and the Interlock state is abnormal in the clientware, but the laser is not locked, and the ALARM light (yellow) is not lit. The output of Ready signal is on high level when the Interlock is normal.

5.2 Alarm solutions

The instructions and solutions of alarms are as follows:

Table 15 Instructions and solutions for alarms of laser

Alarm name	Alarm instructions and solutions
T1/T2 Alarm	<p>Instruction: Low temperature/high temperature alarm of the laser. The sensor in the laser detects an abnormal temperature inside the laser. A high-temperature / low-temperature error occurs when the temperature at the monitoring point exceeds the set upper / lower limit.</p> <p>Solution: High temperature alarm, please check if the water-cooling system is normally working, the water temperature is set correctly, and the water connection is correct. When the water cooling system works normally and the water temperature drops below 30°C, restart the laser. Low temperature alarm, please check if the actual water temperature of the water is too low. In addition, a low ambient temperature may also cause a low temperature alarm when the laser is cold. Please wait until the water temperature of the water rises above 10°C.</p>
Hum Alarm	<p>Instruction: There is a condensation alarm inside the laser. The dew point temperature inside the laser is less than 22°C, and there is a condensation risk.</p> <p>Solution: Immediately stop using the laser. Measure 1: Connecting clean and dry air from CDA port to reduce relative humidity. Measure 2: Installing cabinet air conditioner to reduce ambient temperature.</p>
Laser Water flow	<p>Instruction: The water flow rate of the laser alarms. The current water flow rate detected inside the laser is lower than the required value, and there is a safety risk.</p> <p>Solution:</p>

	<p>Stop using the laser immediately. Please check the output model and working status of the laser water cooler and clean the laser water filter module according to the laser operation requirements in the section 3.3 cooling System Installation and Requirements. It is recommended to clean the water cooler and the water inlet filter assembly regularly, and replace the cooling water.</p>
<p>Scattered Light Alarm</p>	<p>Instruction: Scattering light alarm, when the intensity of ambient light inside the laser exceeds the set value, the scattering light alarm will be generated, and the laser emission function will be locked (cannot be unlocked). The scattered light alarm only occurs when the laser emission.</p> <p>Solution: Please restart the laser, check the guide laser state of the laser, and through the clientware "from the control module" reading the scattered light monitoring voltage value, and contact Raycus.</p>
<p>Laser Power Alarm</p>	<p>Instruction: The alarm is generated when the emission of the laser cannot reach the set value. Power error occurs only when the laser is emitting.</p> <p>Solution: Please restart the laser, check the red light state of the laser, and contact Raycus.</p>
<p>ACDC Alarm</p>	<p>Instruction: ACDC Error, failure of the laser power supply or sudden power failure of the power supply system may cause an alarm.</p> <p>Solution: Check if the input AC voltage is normal. Restart the laser, if this error continues to occur, please contact Raycus.</p>
<p>Current Driver Alarm</p>	<p>Instruction: Current Driver Alarm, this error occurs when the constant current driver board inside the laser is abnormal.</p> <p>Solution: Restart the laser, If this error continues to occur, please contact Raycus</p>

In addition to the above, if there are any questions or errors in using of the laser, you can contact Raycus to get help.

6 Warranty, Return and Maintenance

6.1 General Warranty

Raycus warrants that all Raycus fiber laser products are conformed to applicable product specifications under normal use and are free from defects in materials and workmanship. The warranties start on the date of shipment from Raycus for a period of time as set forth in the applicable purchase contracts or product specifications. Raycus has the right to choose to repair or replace any product that proves to be defective in materials and workmanship selectively during the warranty period. Only products with particular defects are under warranty. Raycus reserves the right to issue a credit note for any defective products produced in normal conditions.

6.2 Limitations of Warranty

The warranty does not cover the maintenance or reimbursement of our product of which the problem results from tampering, disassembling, misuse, accident, modification, unsuitable physical or operating environment, improper maintenance, damages caused by those who are not from Raycus due to excessive use or not following the instructions. Customer has the responsibility to understand and follow this instruction to use the device. Any damage caused by fault operating is not warranted. Accessories and fiber connectors are excluded from this warranty.

According to the warranty, client should write to us within 31 days after the defect is discovered. This warranty does not involve any other party, including specified buyer, end-user or customer and any parts, equipment or other products produced by other companies.



◆ It is the customer's responsibility to understand and follow operating instructions in this UserGuide and specifications prior to operation-failure to do so may void this warranty. Accessories and fiber connectors are not covered by this warranty.

6.3 Service and Repair

- a) Do not open the device. There are no user serviceable parts, equipment or assemblies for user in this product. All service and maintenance shall be performed by qualified Raycus personnel.
- b) Please contact Raycus as soon as possible when problems under warranty about maintenance happened to the product.
- c) The product returned with permission should be placed in a suitable container.

- d) If any damage happened to the product, please notify the carrier in document immediately.

We reserve the right to make changes in design or constructions of any of our products at anytime without incurring any obligation to make changes or install the same on units previously purchased.

All the items about warranty and service above provided by Raycus are for user's reference; formal contents about warranty and service are subject to the contract.

© 2021 Wuhan Raycus Fiber Laser technologies Co. Ltd, All Rights Reserved.