



**Aqua Pulse
Spas**

CONTACT DETAILS

EMAIL: sales@aquapulsespas.com.au

WEB: www.aquapulsespas.com.au

PHONE: (07) 3208 4625

BRONTE DELUXE

PLATINUM SPA

USER MANUAL

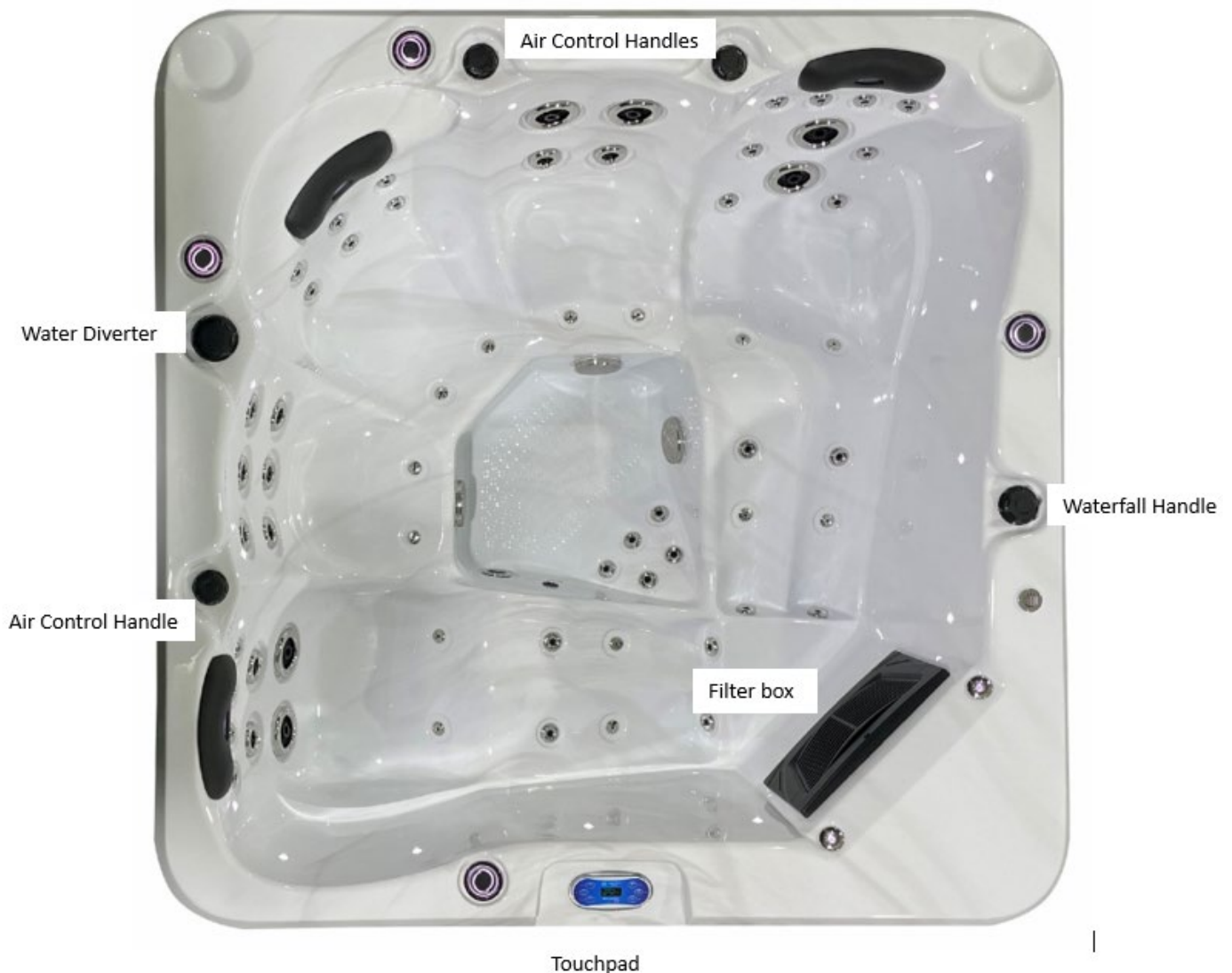

Contents:

3	Important safety instructions
3	Warnings
4	Hyperthermia
4	Considerations required for the location of your spa
4	Spa foundation
4	Water supply
5	Electrical safety
5	Electrical installation
5	Electrical connection point location
6	Wiring diagram
6	Important usage warnings – non warranty faults
7	Water treatment
8	How to remove your spas filter
8	Weekly filter cleaning
8	Filling your spa with water – avoiding air locks
9	Vinyl cover Installation
9	Vinyl cover use & care
9	Cabinet care
9	Acrylic shell care
10	Empty spa warning
10	Draining the spa – using the drain fitting
11	Opening & closing water jets
11	Waterfall handle
11	Air control handle
11	Diverter handle
11	Frost prevention system
11	Ozonator
12-26	Touchpad Instructions

IMPORTANT SAFETY INSTRUCTIONS

Your physiological response to hot water is very subjective and depends on your age, health and medical history. If you don't know your tolerance to hot water or experience dizziness, headaches, or nausea you should exit the spa immediately and cool down.

WARNINGS

Children in and around the spa should be supervised at all times by a responsible adult.

- Use caution when entering or exiting the spa, where practical install a safety grab bar or handrail and set of stairs with non-slip tape on the stair treads (cease use of the stairs immediately if the non-slip tape is not intact). Turn off all the jets before entering or exiting the spa to improve visibility while entering or exiting the spa. Remember that wet surfaces can be slippery.
- Do not allow anyone to submerge their head under the water.
- Do not use the spa unless all suction guards are installed to prevent body and hair entrapment. Do not sit in front of or on top of the suction fittings or skimmer. This will obstruct proper circulation of the water and may result in personal injury.
- Never operate the spa pumps without having all suction and return lines open.
- Always keep the vinyl cover installed and locked when the spa is not in use.
- Never allow anyone to sit or stand on the vinyl cover.
- People using medications and or having any adverse medical history should consult a physician before using the spa.
- People with infectious diseases should not use the spa.
- Do not use the spa if you are under the influence of alcohol or drugs.
- Do not consume alcohol or drugs while using the spa.
- Pregnant women should consult a physician before using the spa.
- As prolonged immersion in water temperatures more than 38°C (100°F) may damage your health, we recommend measuring the water temperature with an accurate thermometer before entering the spa. We also recommend establishing lower temperatures and shorter periods of use for users who may be affected by hot water temperature.
- To avoid the possibility of hyperthermia (heat stress) occurring it is recommended that the average temperature of spa-pool water should not exceed 38°.
- Do not use the spa immediately following strenuous exercise.
- You must use a Licenced Electrical Contractor to connect the spa to power.
- The power must be supplied through a residual current device (RCD) to Australian Standards.
- If your power supply cable is damaged switch the spa off at the residual current device inside yourhouses meter box, contact a Licenced Electrical Contractor to replace the cable.
- Live parts and connections must be inaccessible to any person in the spa.
- Earthed appliances must be permanently connected to fixed wiring.
- Do not permit or use electric appliances (such as lighting, telephone, radios, televisions etc.) within 2 meters of the spa.
- Test the GFCI (Ground Fault Circuit Interrupter) or residual current device (RCD) monthly.
- If water is leaking from the spa stop using the spa and turn it off at the residual current device (RCD) in the meter box until a qualified technician has resolved the problem.
- In daylight hours do not leave the spa empty or partially empty of water for any period of time, this can cause terminal damage to the spa fibreglass shell & acrylic layer.
- Post emergency phone numbers for Police, Fire Department and Ambulance at the nearest phone.
- Install a CPR Resuscitation chart within easy view of the spa.
- Check with your local council to see if you require a building & fencing permit for your spa.

HYPERTHERMIA

Since your spa can be set to reach temperatures of 40°C (104°F) users should be aware that extended submersion in water that exceeds normal body temperature can lead to hyperthermia. Hyperthermia occurs when the internal temperature of the body reaches several degrees above the normal body temperature of 37°C (98.6°F). The symptoms of hyperthermia include drowsiness, lethargy, and an increase in the internal temperature of the body. The effects of hyperthermia include:

- Unawareness of impending hazard.
- Failure to perceive heat.
- Failure to recognize the need to exit the spa.
- Physical inability to exit the spa.
- Foetal damage in pregnant woman.
- Unconsciousness resulting in the danger of drowning.

If you feel any of the symptoms of hyperthermia safely exit the spa immediately. Please note that the use of Alcohol, Drugs or Medication can significantly increase the risk of Hyperthermia.

CONSIDERATIONS REQUIRED FOR THE LOCATION OF YOUR SPA

Contact your local council to determine if a building permit is necessary and for information on applicable bylaws (distance from property lines, buildings, fencing requirements etc.). If you are doing any excavating contact Dial before You Dig on 1100 to ensure that there are no underground lines.

Locate the spa where possible within close distance of a door to the house, this will maximize potential winter use. If possible, locate the spa where you will enjoy some privacy. Make sure your spa is positioned so that access to all cabinet panels will not be blocked. Blocking access to any cabinet panel on the spa will render the spa unserviceable, you must have 900mm of clear uninterrupted space on all sides of the spa for a service technician to have space to make repairs. Service technicians will not move your spa to gain access to a cabinet panel which has been blocked in. Decking in your spa is not recommended you may render your spa unserviceable if the entire deck is not easily removable. Our technicians will not remove your deck to service your spa.

SPA FOUNDATION

Your spa needs a good solid foundation supporting the whole base of the spa. The foundation on which your spa sits must be able to support the weight of the spa the water in it and the weight of its users. If the foundation is inadequate the spa may shift, this will cause stress to the spa shell which may lead to the shell cracking. Damage caused by an inadequate or improper foundation is not covered under this warranty. It is the responsibility of the spa owner to provide a proper foundation for the spa. A spa containing both water and people is extremely heavy, if you are installing the spa onto decking or any other elevated structure you must consult a structural engineer to ensure that the structure will support the weight of the spa. Ideally the spa should be installed onto a concrete base at least 4" thick with reinforcing steel inside the concrete. If you are installing your spa indoors ensure that your choice of flooring is impermeable to water. Ensure that water drains away from the spa protecting the cabinet and electrical components from water damage. Do not place any item underneath the spas base to level the spa this will cause stress to the spa shell which may lead to the shell cracking. Damage caused by packing under the spas fibreglass base is not covered under this warranty.

WATER SUPPLY

Spas do not require a permanent water supply however there must be a water supply and hose within reach to fill the spa.

ELECTRICAL SAFETY

Do not place your spa within 3 metres of overhead power lines.

In case of an emergency, you must have an accessible power shut off point within 3 meters of the spa.

ELECTRICAL INSTALLATION

NEVER CONNECT POWER TO THE SPA USING AN EXTENSION LEAD.

The use of an extension lead will void your spas warranty.

You will need a suitable electrical supply to run the spa.

The Bronte Deluxe Platinum Spa requires a 10Amp Residual Current Device Protected Dedicated Power Connection. Your Licenced Electrical Contractor can hardwire the spa straight to the meter box in your house or they can install a 10Amp residual current device protected dedicated single power plug.

It is the responsibility of your Licenced Electrical Contractor to ensure the Residual Current Device is installed at the correct mA required by the law.

When appointing an electrician to prepare your spas electrics check that they are suitably qualified and licenced to do so. Do not attempt to install the spas electrics yourself if you are not a fully Licenced Electrical Contractor.

If your spa is being hardwired, we recommend you install a Rotary Isolation Switch so that the spa can be isolated from the power supply in an emergency or for service work. This is simply a rotary on/off switch but should be sited more than 2 metres away from the spa so that users cannot be in the spa whilst operating the switch.

3 Pin Plug



Rotary Isolation Switch

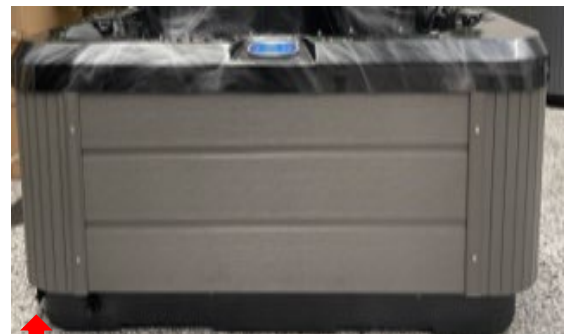

ELECTRICAL CONNECTION POINT LOCATION

If you have chosen to hardwire the spa your Licenced Electrical Contractor will locate the electrical connection point here, unscrew and remove the cabinet panels directly underneath the spas touch pad.

Once the spa has power connected to it and it is filled with water your electrician can turn the power on. Never turn the spa on if you do not have it filled with water.

While your electrician is still on site press the jets button you should now have water movement within the spa.

If you have no water movement at this stage have your electrician, contact the store while they are still onsite.

Wiring Diagram

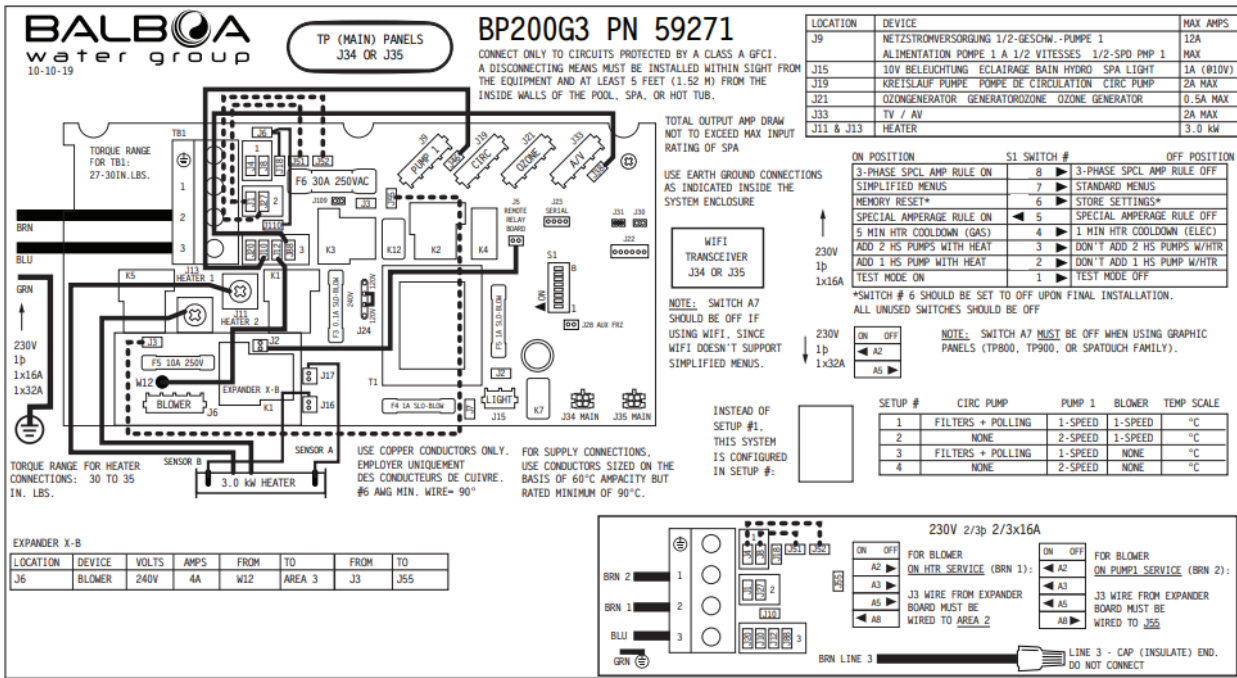

IMPORTANT USAGE WARNINGS – NON WARRANTY FAULTS

Spas are extremely delicate products and require regular maintenance. Below we will list a number of common causes of problems which are not covered under this warranty. Should we ever need to visit you to repair your spa you will be charged the full cost of a repair if we found that the cause was the result of poor maintenance or customer negligence. Paying full attention to the issues below will help to reduce the risk of damage to your spa.

WATER TREATMENT

The most crucial aspects of spa maintenance is water treatment. Improper water balance will cause damage to the spas fibreglass shell, acrylic shell, pumps, jets, heater, headrests, vinyl cover and fittings. If we find improper water balance in your spa, these parts will not be covered under this warranty.

Please note that your spas headrests and filter box face are sensitive to chemical exposure, they will eventually discolour and turn white. If you over sanitize the water or allow them to float in the water, this can happen immediately. Discoloured headrests and filter box faces will not be covered under this warranty. Do not clean the spas headrests or filter box face with the spas water only use fresh tap water to clean the headrests and filter box faces.

We recommend that you have the spa water tested weekly at a professional pool or spa store to gain accurate results of the water chemistry. When you test at other pool or spas stores, you can use the test results they give you to calculate any adjustments you need to make using our how to balance the water instructions. You do need to be careful to not just apply the amounts of chemical that they tell you to apply. The reason for this is that they might set the parameters differently to what your spa requires.

Water chemistry test history from a professional pool or spa store showing results for Free chlorine, Total chlorine, pH, Alkalinity, Calcium hardness, Cyanuric acid & Salt must be kept as a dated once-a-month digital reference as part of your warranty terms. This test history will be required in the event of a warranty claim. Your warranty will be made void if you cannot show these results, or these results show you have used chemicals with ingredients we have asked you not to use or the results show you have not maintained the water to the ideal readings we have provided you with.

CHEMICALS WITH ANY OF THESE INGREDIANTS CANNOT BE USED IN YOUR SPA.

Bromine, Granular chlorine calcium, Trichlor chlorine, Dichlor chlorine, Stabilised chlorine, Cyanuric acid, Liquid pool chlorine, Hydrochloric acid, Magnesium, Epsom salt, Hydrogen peroxide chlorine free, Phlihexanide hydrochloride chlorine free, Polyhexamethylene biguanide chlorine free.

THESE CHEMICALS ARE ALL KNOWN TO CAUSE SOME FORM OF DAMAGE TO FIBREGLASS - ACRYLIC SPAS.

SOME OF THESE CHEMICALS WILL BREAK DOWN THE BONDS OF THE FIBREGLASS – ACRYLIC SHELL WHICH ALLOWS THE FIBREGLASS – ACRYLIC SHELL TO BE RE SHAPPED. THE WEIGHT OF THE WATER WILL PUSH DOWN ON THE FIBREGLASS – ACRYLIC SHELL AND RESHAPE IT OVER THE STAINLESS-STEEL STRUCTURAL FRAME CAUSING THE STRUCTURAL FRAME TO BECOME VISABLE THROUGH THE SHELL. SOME OF THESE CHEMICALS WILL BREAK DOWN THE ACRYLIC SHELL CAUSING BUBBLES & HOLES IN THE ACRYLIC SHELL.

THESE ISSUES ARE IRREVERSABLE.

Your warranty will be made void if you use any of these chemicals, even if you only used it once.

If your monthly water test results show any amounts of these chemicals in your water, please contact your store of purchase immediately for advice.

HOW TO REMOVE YOUR SPAS FILTERS

Remove the flat head screw in the filter box face and dispose of it.
DO NOT REINSTALL THE SCREW.

1. Slide the face plate on the filter box vertically upwards until it separates away from the filter box.
2. Remove the leaf catcher by sliding it horizontally towards the centre of the spa.
3. To remove the filters, turn the handle on the top of each filter anti-clockwise until you can lift each filter out of the filter box.
4. To install the filters, place each filter inside the filter box and turn the handle on the top of each filter clockwise. Do not turn the filters with force just gently screw them in. Tightening the filters to firmly will break the thread on the filters.
5. To install the leaf tray slide it horizontally into the filter box, make sure the tray sits in the middle of the locating grooves. The filter face plate will not install if you have the leaf tray outside of the locating grooves.
6. To install the face plate on the filter box slide the face plate vertically downwards.



Note: The black filter box face is sensitive to chemical exposure, it will eventually discolour and turn white. If you over sanitize the water this can happen immediately.

WEEKLY FILTERS CLEANING

Once a week remove the filters from the spa and wash thoroughly with a garden hose, then place the filters in a bucket of cold water and add 125ml of Filter Cleaner & Degreaser #9 or Filter Cleaner & Degreaser 1Litre Bottle. Agitate the water and leave the filters submerged to soak for 24 hours. After 24 hours remove the filters, wash them thoroughly and allow them to completely dry out in an area exposed to the sun or wind. It is recommended to purchase spare filters and alternate between the filters each week to make the cleaning process easier. Filters which are not cleaned weekly can cause your spa to stop cleaning & heating. You filter needs to be replaced every twelve months, however if you are rotating between two sets of filters this will require replacement every two years.

To order your replacement filter <https://www.aquapulsespas.com.au/products/universal-cartridge-filter-2>

FILLING YOUR SPA WITH WATER – AVOIDING AIR LOCKS

The correct way to fill your spa with water is to remove the spas filters and place your hose inside the filter box. Be sure to remove the fitting off the hose to prevent it from falling into the spas plumbing.

Placing the hose inside the spas main seating area may cause a build-up of air inside the plumbing creating an air lock. Air locks can stop the pumps and heater from working.

To help avoid this problem ensure you fill the spa through the filter box. You can tell if you have an air lock by turning on the pumps, if no water appears to circulate through the system, it is very likely that you have an air lock. To resolve this problem, turn the pump off and loosen the unions at the side of the suction end of the pump until water begins to flow through, then retighten the union and try turning the pump on again. Alternatively contact the store of purchase for advice on other ways to remove an air lock.



Note:

Please ensure the drain fitting is closed before filling the spa with water, see instructions on page 10.

VINYL COVER INSTALLATION

Locate the screws and keys, which are packaged inside the vinyl cover.

Place the vinyl cover on top of the spa. Your vinyl cover is not square, you may need to rotate it to fit the spa.

On each strap of the vinyl cover there is a black plastic lock. Press the two prongs on each lock together and gently pull downwards to remove the section of the lock which you will need to screw onto the spas cabinet. With the section of the lock you have in your hand place it behind the prongs which are attached to the vinyl cover strap lined up so that the bottom of each part is flush. Now raise the section of the lock you have in your hand towards the top of the spa by 2cm and mark the position of the two holes on each lock onto the spas cabinet. Using the screws supplied screw each lock onto the spas cabinet. Do not pre-drill holes the screws will self-tap in, if using a drill stop before the screw is completely tight and finish tightening the screw by hand, if you over tighten the lock you will crack the plastic.

VINYL COVER USE & CARE

To lift the vinyl cover, place your hand underneath the valance and lift the vinyl cover itself. The handles & valance on the vinyl cover are not for lifting or pulling the vinyl cover, lifting or pulling on the handles or valance will tear the vinyl & stitching. Never stand, sit, or apply any weight to the vinyl cover this will bend or break the vinyl cover. Do not open the zippers on your vinyl cover they can be extremely difficult to close and may not close at all. To clean your vinyl cover wipe both the top vinyl and underside over with a damp fresh tap water cloth. Do not use the spas water to wipe the vinyl cover this will leave chemical stains on the vinyl. To extend the life expectancy of your vinyl cover apply 303 aerospace protectant to the vinyl side of your vinyl cover every 30 days and balance your spas water weekly as per the chemical instructions we have supplied you with. Poorly balanced water can blister your vinyl cover, breakdown the stitching & leave algae stains on the cover.

Your vinyl cover must always be locked to the spas cabinet when the spa is not in use. Leaving the vinyl cover off exposes your spa to the elements which can cause permanent damage to the spas acrylic shell and fittings, it also allows leaves, dust etc. to enter your spa. Debris in the spa can cause blockages or damage to the equipment.

CABINET CARE

Do not use any chemicals to clean your cabinet. The best way to clean your cabinet is to regularly wipe it down with a micro fibre cloth and fresh tap water. Where possible try to keep the cabinet from being exposed to the sun as this causes colour fade in the cabinet and can also cause the cabinet to warp.

ACRYLIC SHELL CARE

Once a week use a chemical free micro fibre cloth and wipe down the acrylic spa shell in and above the water line. The acrylic will show scratches, crazing and chaffing marks, this is unavoidable and is not a manufacturing fault it's normal wear and tear for acrylic.

EMPTY SPA WARNING

An empty or partially empty spa of water during daylight hours can cause deforming, changes to the shape of the shell, melting, crazing, discolouration, blisters or holes in the spa's fiberglass, acrylic and fittings, this can happen within minutes of the spa being emptied or partially empty. Your warranty does not cover deforming, changes to the shape of the shell, melting, crazing, discolouration, blisters or holes in the spa's acrylic and fittings, so it is especially important your vinyl cover is on the spa when not in use and the spa is filled with water at all times during daylight hours.

DRAINING THE SPA - USING THE DRAIN FITTING WARNING:

Never drain or partially drain your spa of water in daylight hours.

Always drain your spa at night time & fully refill your spa with water the same night.

An empty or partially empty spa of water during daylight hours can cause deforming, changes to the shape of the shell, melting, crazing, discolouration, blisters or holes in the spa's fiberglass, acrylic and fittings, this can happen within minutes of the spa being emptied or partially empty. Your warranty does not cover deforming, changes to the shape of the shell, melting, crazing, discolouration, blisters or holes in the spa's acrylic and fittings, so it is especially important your vinyl cover is on the spa when not in use and the spa is filled with water at all times during daylight hours.



LOCATION OF DRAIN FITTING

To locate your drain fitting it will be found on the touchpad side of the spa in the left-hand corner of the black fibreglass base.

To operate the drain fitting turn the larger black round section of the fitting to the left. Now unscrew & remove the smaller black cap by turning it to the left, this will expose a thread which you can now screw the supplied garden hose fitting onto, turn the hose fitting to the right to screw it on. Now connect your garden hose to the hose fitting and gently pull the garden hose away from the spa this will open the valve to allow the spa to drain. Once drained remove the garden hose and garden hose fitting. Reinstall the smaller black cap, screw it on by turning it to the right, then push the smaller black cap towards the fibreglass base of the spa to close the valve from draining. Now turn the larger black round section of the fitting to the right, this will prevent it from opening and leaking water on refilling the spa.

OPENING & CLOSING WATER JETS

The larger water jets in your spa can be manually turned on or off.

Turning the stainless-steel jet face clockwise will turn the jet on which will allow the water to flow through the jet. Turning the stainless-steel jet face anticlockwise will turn the jet off slowing the water from flowing through the jet. The smaller stainless-steel jets in your spa can not be opened & closed, they will always remain open.

WATERFALL HANDLE

Your waterfall handle can be located on the spa image on page one.

To run your waterfalls, turn on a water pump and turn the waterfall handle to the left.

To turn the waterfalls off turn the waterfall handle to the right.

Do not apply force to the handle at the fully open or fully closed positions you will break it if you do, turn it softly.

The waterfall handle must be in the closed position when the spa has its vinyl cover on.

AIR CONTROL HANDLES

The air control handles can be located on the spa image on page one.

These handles control the amount of air pressure the jets receive.

Turning the handle to the left will increase the water jets pressure.

Turning the handle to the right will decrease the water jets pressure.

WATER DIVERTER

The diverter handle can be located on the spa image on page one.

This handle is used to move where the water is delivered within the spa.

When you turn the handle to different positions the water pressure will change and move location within the spa. When the pumps are running this handle will make loud noise from the water pressure flowing through the handle, the noise level will vary depending on where the handle is positioned.

Do not turn this handle while the pumps are running and do not apply force to the handle at the fully open or fully closed positions you will break it if you do, to make adjustments turn the handle softly when the pumps are turned off.

MY SPA IS TOO HOT IN SUMMER, THE TEMPERATURE OF THE WATER IS HIGHER THAN I HAVE SET

During summer there may be times when the spas water exceeds the set temperature. This is not a fault in the spa it is simply the ambient air temperature causing this. To combat this problem, you can use ice to cool down the water.

FROST PREVENTION SYSTEM

If the temperature of the spas water drops below 5°C the spa will switch on the heater until the spa reaches the temperature of 8°C.

OZONATOR

The spas ozonator will automatically turns itself on when the spa is running filter cycles, there are no adjustments you are able to make. When the ozonator is running, the bubbles you see and the noise level you hear will vary. Sometimes you will see less bubbles and hear less noise, sometimes you will see more bubbles and hear more noise, this is normal operation and is not cause for concern.

TP500 and TP500S Control Panels

User Guide for Simplified Menu

System Model: All BP series systems that support Simplified Menus

Panel Model: TP500 and TP500S Series

Panel Software Version: All versions



TP500S



TP500

Display Icons



- | | | |
|-----------------------------|-------------------|--------------------------------------|
| A - Heat | F - Light | K - Auxiliary (Jets 3 or MICROSilk®) |
| B - Ready Mode | G - Cleanup Cycle | L - Temperature Range (High / Low) |
| C - Rest Mode | H - Jets 1 | M - Set (Programming) |
| D - bba™2 On | I - Jets 2 | N - Filter Cycle (1 or 2 or Both) |
| E - WiFi (Cloud Connection) | J - Blower | |

MicroSilk® is a registered trademark of Jason International.

Manufactured under one or more of these patents. U.S. Patents: 5332944, 5361215, 5550753, 559720, 5,881,450, 6253227, 6282370, 6590188, 6979052, 6965815, 7030343, 7,417,834 b2, Canadian Patent: 2342914, Australian patent: 2373248 other patents both foreign and domestic applied for and pending. All material copyright of Balboa Water Group.



Main Menu

Navigation

Navigating the entire menu structure is done with 2 or 3 buttons on the control panel.



Some panels have separate WARM (Up) and COOL (Down) buttons, while others have a single Temperature button. In the navigation diagrams Temperature buttons are indicated by a single button icon. Panels that have two Temperature buttons (Warm and Cool) can use both of them to simplify navigation and programming where a single Temperature icon is shown.





The MENU/SELECT Button is used to choose the various menus and navigate each section.

Typical use of the Temperature button(s) allows changing the Set Temperature while the numbers are flashing in the LCD. The menus can be exited with certain button presses. Simply waiting for a few seconds will return the panel operation to normal.

Power-up Screens

Each time the System powers up, a series of numbers is displayed. After the startup sequence of numbers, the system will enter Priming Mode (See Page 3).

Key

-  Indicates Flashing or Changing Segment
-  Indicates Alternating or Progressive Message - every 1/2 second
-  A temperature button, used for "Action"
-  Menu/Select button
- ***** Waiting time that keeps the last change to a menu item.
- ***** Waiting time (depends on menu item) that reverts to original setting and ignores any change to that menu item.

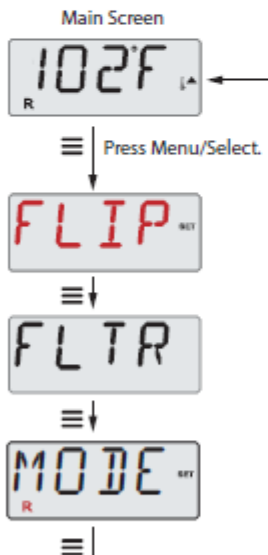

Waiting a few seconds in the Main Menu will allow the display to revert to the Main Screen. Most changes are not saved unless Menu/Select is pressed. Refer to key above.

Manufactured under one or more of these patents. U.S. Patents: 5332944, 5361215, 5550753, 5550720, 5,883,459, 6253227, 6282370, 6590188, 6979052, 6955815, 7030343, 7,417,834 BC, Canadian Patent: 2342614, Australian patent: 2373248 other patents both foreign and domestic applied for and pending. All material copyright of Balboa Water Group.

BALBOA
water group

Fill it up!

Preparation and Filling

Fill the spa to its correct operating level. Be sure to open all valves and jets in the plumbing system before filling to allow as much air as possible to escape from the plumbing and the control system during the filling process.

After turning the power on at the main power panel, the top-side panel display will go through specific sequences. These sequences are normal and display a variety of information regarding the configuration of the hot tub control.

Priming Mode

This mode will last for 4-5 minutes or you can manually exit the priming mode after the pump(s) have primed.

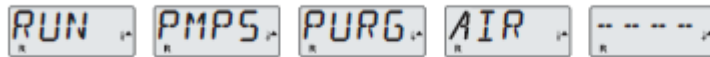

Regardless of whether the priming mode ends automatically or you manually exit the priming mode, the system will automatically start normal heating and filtering at the end of the priming mode. During the priming mode, the heater is disabled to allow the priming process to be completed without the possibility of energizing the heater under low-flow or no-flow conditions. Nothing comes on automatically, but the pump(s) can be energized by pushing the "Jets" or "Aux" buttons.

If the spa has a Circ Pump, it can be activated by pressing the "Light" button during Priming Mode.

Priming the Pumps

As soon as the above display appears on the panel, push the "Jets" button once to start Pump 1 in low-speed and then again to switch to high-speed. Also, push the "Jets 2" or "Aux" button, if you have a 2nd pump, to turn it on. The pumps will now be running in high-speed to facilitate priming. If the pumps have not primed after 2 minutes, and water is not flowing from the jets in the spa, do not allow the pumps to continue to run. Turn off the pumps and repeat the process. Note: Turning the power off and back on again will initiate a new pump priming session. Sometimes momentarily turning the pump off and on will help it to prime. Do not do this more than 5 times. If the pump(s) will not prime, shut off the power to the spa and call for service.

Important: A pump should not be allowed to run without priming for more than 2 minutes. Under NO circumstances should a pump be allowed to run without priming beyond the end of the 4-5 minute priming mode. Doing so may cause damage to the pump and cause the system to energize the heater and go into an overheat condition.

Exiting Priming Mode

You can manually exit Priming Mode by pressing the "Warm" or "Cool" button. Note that if you do not manually exit the priming mode as described above, the priming mode will be automatically terminated after 4-5 minutes. Be sure that the pump(s) have been primed by this time.

Once the system has exited Priming Mode, the top-side panel will momentarily display the set temperature but the display will not show the water temperature yet, as shown below.

This is because the system requires approximately 1 minute of water flowing through the heater to determine the water temperature and display it.



Manufactured under one or more of these patents. U.S. Patents: 5332944, 5361215, 5550753, 5559720, 5,983,459, 6253227, 6282370, 6590188, 6978052, 6955815, 7030343, 7,417,834 b2, Canadian Patent: 2342814, Australian patent: 2373348 other patents both foreign and domestic applied for and pending. All materials copyright of Balboa Water Group.

BALBOA
water group

Spa Behavior

Pumps

Press the "Jets" button once to turn pump 1 on or off, and to shift between low and high speeds if equipped. If left running, the pump will turn off after a time-out period.

On non-circ systems, the low-speed of pump 1 runs when the blower or any other pump is on. If the spa is in Ready Mode (See page 6), Pump 1 low may also activate once in a while for at least 1 minute to detect the spa temperature (polling) and then to heat to the set temperature if needed. When the low-speed turns on automatically, it cannot be deactivated from the panel, however the high speed may be started.

Circulation Pump Modes

If the system is equipped with a circ pump, it will be configured to work in one of three different ways:

- 1, The circ pump operates continuously (24 hours) with the exception of turning off for 30 minutes at a time when the water temperature reaches 3°F (1.5°C) above the set temperature (most likely to happen in very hot climates).
- 2, The circ pump stays on continuously, regardless of water temperature.
- 3, A programmable circ pump will come on when the system is checking temperature (polling), during filter cycles, during freeze conditions, or when another pump or blower is on.

The specific Circulation Mode that is used has been determined by the Manufacturer and cannot be changed in the field.

Filtration and Ozone

On non-circ systems, Pump 1 low and the ozone generator will run during filtration. On circ systems, the ozone will run with the circ pump.

Most spas have one filter cycle per day, but some spas have two filter cycles per day. The first filter cycle occurs 6 minutes after power-up and then every 24 hours. The second filter cycle, if there is one, occurs 12 hours after the first one. The filter duration is programmable. (See page 7.)

At the start of each filter cycle, all water devices (other than the primary pump) will run briefly to purge the plumbing to maintain good water quality. The term "water devices" includes the Blower.

Freeze Protection

If the temperature sensors within the heater detect a low enough temperature, then the pump(s) and the blower automatically activate to provide freeze protection. The pump(s) and blower will run either continuously or periodically depending on conditions.

In colder climates, an optional freeze sensor may be added to protect against freeze conditions that may not be sensed by the standard sensors. Auxiliary freeze sensor protection acts similarly except with the temperature thresholds determined by the switch. See your dealer for details.

Clean-up Cycle (optional)

When a pump or blower is turned on by a button press, a clean-up cycle begins 30 minutes after the pump or blower is turned off or times out. The pump and the ozone generator will run for 30 minutes or more, depending on the system.

Manufactured under one or more of these patents. U.S. Patents: 5332944, 5361215, 5590753, 5590720, 5,883,459, 6253227, 6282370, 6590188, 6979052, 6955815, 7030343, 7,417,834 bc. Canadian Patent: 2342614, Australian patent: 2373248 other patents both foreign and domestic applied for and pending. All material copyright of Balboa Water Group.

BALBOA
water group

Temperature

Adjusting the Set Temperature

When using a panel with Up and Down buttons (Temperature buttons), pressing Up or Down will cause the temperature to flash. Pressing a temperature button again will adjust the set temperature in the direction indicated on the button. When the LCD stops flashing, the spa will heat to the new set temperature when required.

If the panel has a single temperature button, pressing the button will cause the temperature to flash. Pressing the button again will cause the temperature to change in one direction (e.g. UP). After allowing the display to stop flashing, pressing the Temperature Button will cause the temperature to flash and the next press will change the temperature in the opposite direction (e.g. DOWN).

Press-and-Hold

If a Temperature button is pressed and held when the temperature is flashing, the temperature will continue to change until the button is released. If only one temperature button is available and the limit of the Temperature Range is reached when the button is being held, the progression will reverse direction.

Manufactured under one or more of these patents. U.S. Patents: 5332044, 5361215, 5550753, 5559720, 5,883,459, 6253227, 6282370, 6590188, 6979052, 6965815, 7030343, 7,417,834 b2, Canadian Patent: 2342014, Australian patent: 2373248 other patents both foreign and domestic applied for and pending. All material copyright of Balboa Water Group.

BALBOA
water group

Mode – Ready and Rest

In order for the spa to heat, a pump needs to circulate water through the heater. The pump that performs this function is known as the "primary pump."

The primary pump can be either a 2-Speed Pump 1 or a circulation pump.

If the primary pump is a 2-Speed Pump 1, Ready Mode (indicated by **R**) will circulate water periodically, using Pump 1 Low, in order to maintain a constant water temperature, heat as needed, and refresh the temperature display. This is known as "polling."

Rest Mode (indicated by **⏸**) will only allow heating during programmed filter cycles. Since polling does not occur, the temperature display may not show a current temperature until the primary pump has been running for a minute or two.

Circulation Mode (See Page 4, under Pumps, for other circulation modes)

If the spa is configured for 24HR circulation, the primary pump generally runs continuously. Since the primary pump is always running, the spa will maintain set temperature and heat as needed in Ready Mode, without polling.

In Rest Mode, the spa will only heat to set temperature during programmed filter times, even though the water is being filtered constantly when in Circulation Mode.

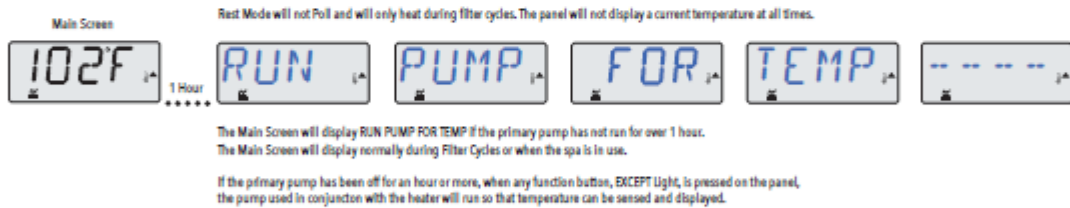
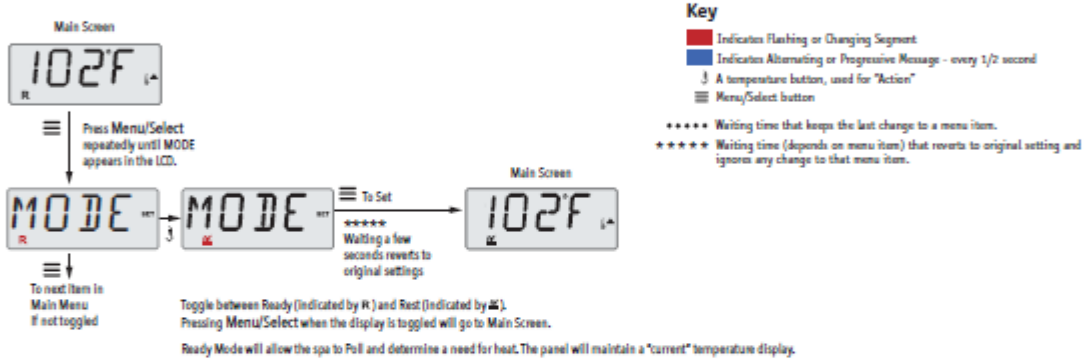

Ready-in-Rest Mode

R ⏸ appears in the display if the spa is in Rest Mode and "Jets" is pressed. It is assumed that the spa is being used and will heat to set temperature. The primary pump will run until set temperature is reached, or 1 hour has passed. After 1 hour, the System will revert to Rest Mode. This mode can also be reset by entering the Mode Menu and changing the Mode.

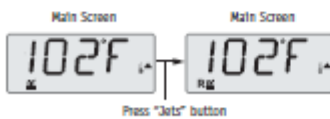

Manufactured under one or more of these patents. U.S. Patents: 5332944, 5361215, 5550753, 5596720, 5,883,459, 6253227, 6282370, 6590188, 6976052, 6965815, 7030343, 7,417,834 b2, Canadian Patent: 2342614, Australian patent: 2373248 other patents both foreign and domestic applied for and pending. All materials copyright of Balboa Water Group.

BALBOA
water group

Flip (Invert Display)

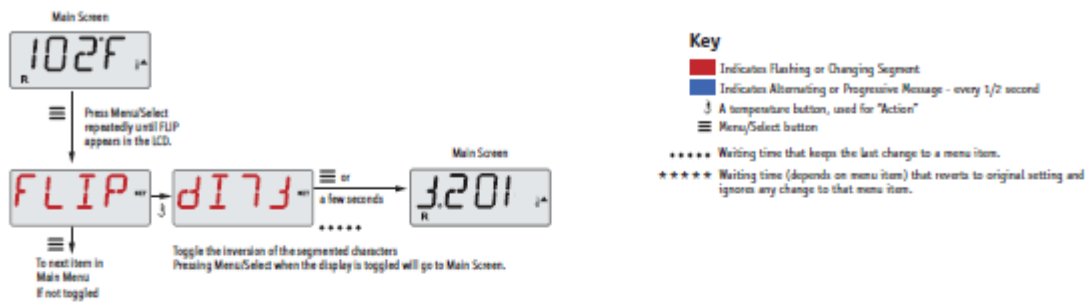

Adjusting Filtration

Main Filtration

Filter cycles are set using a duration. The filter duration setting can be adjusted in 1-hour increments. Filter Cycle 1 and Filter Cycle 2 (if enabled) are set to the same duration.

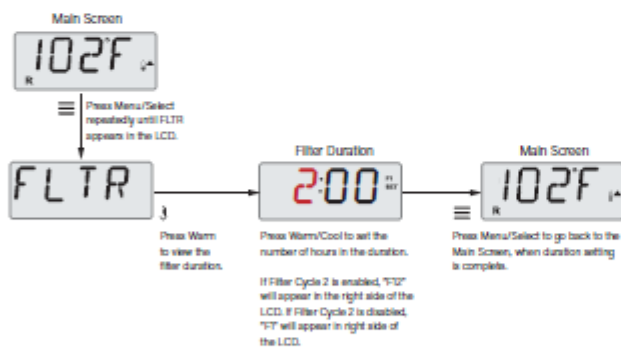

Purge Cycles

In order to maintain sanitary conditions, secondary Pumps and/or a Blower will purge water from their respective plumbing by running briefly at the beginning of each filter cycle.

Manufactured under one or more of these patents: U.S. Patents: 5332944, 5361215, 5590753, 5599720, 5,883,459, 6253227, 6282370, 6590188, 6976032, 6995815, 7030343, 7,417,834 b2, Canadian Patent: 2342614, Australian patent: 2373248 other patents both foreign and domestic applied for and pending. All material copyright of Balboa Water Group.

BALBOA
water group

General Messages

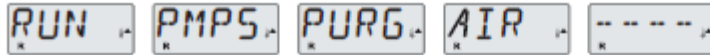

Priming Mode

Each time the spa is powered up, it will enter Priming Mode. The purpose of Priming Mode is to allow the user to run each pump and manually verify that the pumps are primed (air is purged) and water is flowing. This typically requires observing the output of each pump separately, and is generally not possible in normal operation. Priming Mode lasts 4 minutes, but you can exit it earlier by pressing any Temp button. The heater is not allowed to run during Priming Mode.

NOTE: If your spa has a Circ Pump, it will turn on with "Light" in Priming Mode. The Circ Pump will run by itself when Priming Mode is exited.



Water Temperature is Unknown

After the pump has been running for 1 minute, the temperature will be displayed.

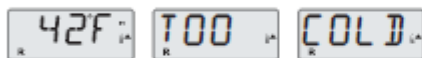

Too Cold - Freeze Protection

A potential freeze condition has been detected, or the Aux Freeze Switch has closed, and all pumps and blower are activated, either one at a time, or all at once, depending on how your system was built. All pumps and blower are ON for at least 4 minutes after the potential freeze condition has ended, or when the aux freeze switch opens.

In some cases, pumps may turn on and off and the heater may operate during Freeze Protection.

This is an operational message, not an error indication.

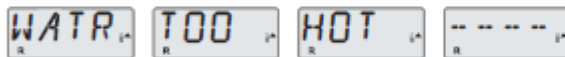

Water is too Hot (OHS)

One of the water temp sensors has detected spa water temp 110°F (43.3°C) and spa functions are disabled. System will auto reset when the spa water temp is below 108°F (42.2°C). Check for extended pump operation or high ambient temp.

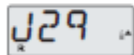

J29 Warning

J29 is typically used as a Heater Disable input. As such, it should not typically be shorted at power-up. This message appears if J29 is shorted at power-up.

* This message can be reset from the topside panel with any button press.

Manufactured under one or more of these patents. U.S. Patents: 5332044, 5361215, 5550753, 5559720, 5,883,450, 6253227, 6282370, 6590186, 6970052, 6965815, 7030343, 7,417,834 b2, Canadian Patent: 2342614, Australian patent: 2373248 other patents both foreign and domestic applied for and pending. All materials copyright of Balboa Water Group.

BALBOA
water group

Heater-Related Messages



Heater Flow is Reduced (HFL)

There may not be enough water flow through the heater to carry the heat away from the heating element. Heater start up will begin again after about 1 min. See "Flow Related Checks" below.



Heater Flow is Reduced (LF)*

There is not enough water flow through the heater to carry the heat away from the heating element and the heater has been disabled. See "Flow Related Checks" below. After the problem has been resolved, you must press any button to reset and begin heater start up.

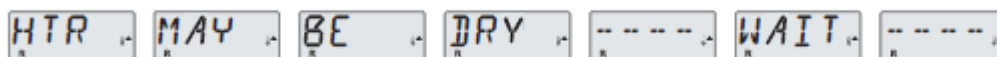

Heater may be Dry (dr)*

Possible dry heater, or not enough water in the heater to start it. The spa is shut down for 15 min. Press any button to reset the heater start-up. See "Flow Related Checks" below.

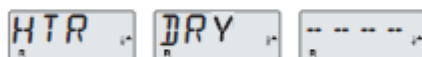

Heater is Dry*

There is not enough water in the heater to start it. The spa is shut down. After the problem has been resolved, you must press any button to reset and restart heater start up. See "Flow Related Checks" below.



Heater is too Hot (OHH)*

One of the water temp sensors has detected 118°F (47.8°C) in the heater and the spa is shut down. You must press any button to reset when water is below 108°F (42.2°C). See "Flow Related Checks" below.

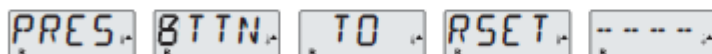

A Reset Message may Appear with other Messages.

Some errors may require power to be removed and restored.

Flow-Related Checks

Check for low water level, suction flow restrictions, closed valves, trapped air, too many closed jets and pump prime.

On some systems even when spa is shut down, some equipment may occasionally turn on to continue monitoring temperature or if freeze protection is needed.

* This message can be reset from the topside panel with any button press.

Manufactured under one or more of these patents. U.S. Patents: 5332944, 5361215, 5550753, 5559720, 5,863,459, 6253227, 6282370, 6590186, 6978052, 6955815, 7030343, 7,417,834 bc, Canadian Patent: 2342614, Australian patent: 2373248 other patents both foreign and domestic applied for and pending. All materials copyright of Balboa Water Group.

BALBOA
water group

Sensor-Related Messages

102°F SNSR BAL ANCE

Sensor Balance is Poor

The temperature sensors MAY be out of sync by or 3°F. Call for Service.

SNSR SYNC -- -- -- CALL FOR SRVC -- -- --

Sensor Balance is Poor*

The temperature sensors ARE out of sync. The Sensor Balance is Poor fault has been established for at least 1 hour. Call for Service.

SNSR A -- -- -- CALL FOR SRVC -- -- --
B

Sensor Failure – Sensor A, Sensor B

A temperature sensor or sensor circuit has failed. Call for Service.

Miscellaneous Messages

NO COMM

No Communications

The control panel is not receiving communication from the System. Call for Service.

BETA VERSION SION -- -- --

Pre-Production Software

The Control System is operating with test software. Call for Service.

102°F

°F or °C is replaced by °T

The Control System is in Test Mode. Call for Service.

* This message can be reset from the topside panel with any button press.

Manufactured under one or more of these patents. U.S. Patents: 5332944, 5361215, 5550753, 5559720, 5883459, 6253227, 6282370, 6590188, 6978052, 6965815, 7030343, 7,417,834 b2, Canadian Patent: 2342614, Australian patent: 2373248 other patents both foreign and domestic applied for and pending. All materials copyright of Balboa Water Group.

BALBOA
water group

System-Related Messages



Memory Failure - Checksum Error*

At Power-Up, the system has failed the Program Checksum Test. This indicates a problem with the firmware (operation program) and requires a service call.



Memory Warning - Persistent Memory Reset*

Appears after any system setup change. Contact your dealer or service organization if this message appears on more than one power-up, or if it appears after the system has been running normally for a period of time.

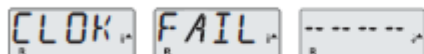

Memory Failure - Clock Error*

Contact your dealer or service organization.

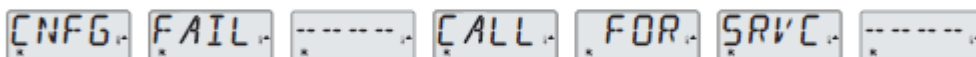

Configuration Error – Spa will not Start Up

Contact your dealer or service organization.



GFCI Failure - System Could Not Test/Trip the GFCI

NORTH AMERICA ONLY. May indicate an unsafe installation. Contact your dealer or service organization.

* This message can be reset from the topside panel with any button press.

Manufactured under one or more of these patents. U.S. Patents: 5332944, 5361215, 5550753, 5559720, 5,883,459, 6253227, 6282370, 6590188, 6979052, 6955815, 7030343, 7,417,834 BC, Canadian Patent: 2342914, Australian patent: 2373248 other patents both foreign and domestic applied for and pending. All materials copyright of Balboa Water Group.

BALBOA
water group

System-Related Messages (Continued)



A Pump Appears to be Stuck ON

Water may be overheated. POWER DOWN THE SPA. DO NOT ENTER THE WATER. Contact your dealer or service organization.

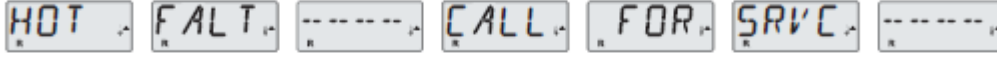

A Pump Appears to have been Stuck ON when spa was last powered

POWER DOWN THE SPA. DO NOT ENTER THE WATER.
Contact your dealer or service organization.



The water level is too low

Some systems have a water level detect, and this message appears if it detects that the water level is too low.

Reminder Messages

General maintenance helps.

The display of Reminder Messages can be suppressed by using the PREF Menu. See Page 12.

Reminder Messages can be chosen individually by the Manufacturer. They may be disabled entirely, or there may be a limited number of reminders on a specific model.

The frequency of each reminder (e.g. 7 days) can be specified by the Manufacturer.

Press a Temperature button to reset a displayed reminder message.



Alternates with temperature or normal display.

Appears on a regular schedule, e.g. every 7 days.

Check pH with a test kit and adjust pH with the appropriate chemicals.



Alternates with temperature or normal display.

Appears on a regular schedule, e.g. every 7 days.

Check sanitizer level and other water chemistry with a test kit and adjust with the appropriate chemicals.

* This message can be reset from the topside panel with any button press.

Manufactured under one or more of these patents. U.S. Patents: 5332944, 5361215, 5590753, 5599720, 5,883,450, 6253227, 6282370, 6590188, 6979052, 6965815, 7030343, 7,417,834 bc, Canadian Patent: 2342614, Australian patent: 2373248 other patents both foreign and domestic applied for and pending. All materials copyright of Balboa Water Group.

BALBOA
water group



Alternates with temperature or normal display.

Appears on a regular schedule, e.g. every 30 days.

Clean the filter media as instructed by the manufacturer. See HOLD on page 9.



Alternates with temperature or normal display.

Appears on a regular schedule, e.g. every 30 days.

The Ground Fault Circuit Interrupter (GFCI) or Residual Current Device (RCD) is an important safety device and must be tested on a regular basis to verify its reliability.

Every user should be trained to safely test the GFCI or RCD associated with the hot tub installation. A GFCI or RCD will have a TEST and RESET button on it that allows a user to verify proper function.

Warning:

If freezing conditions exist, a GFCI or RCD should be reset immediately or spa damage could result. The end user should always be trained to test and reset the GFCI or RCD on a regular basis.



Alternates with temperature or normal display.

Appears on a regular schedule, e.g. every 90 days.

Change the water in the spa on regular basis to maintain proper chemical balance and sanitary conditions.



Alternates with temperature or normal display.

Appears on a regular schedule, e.g. every 180 days.

Vinyl covers should be cleaned and conditioned for maximum life.



Alternates with temperature or normal display.

Appears on a regular schedule, e.g. every 180 days.

Wood skirting and furniture should be cleaned and conditioned per the manufacturers instructions for maximum life.



Alternates with temperature or normal display.

Appears on a regular schedule, e.g. every 365 days.

Filters should be replaced occasionally to maintain proper spa function and sanitary conditions.

Manufactured under one or more of these patents. U.S. Patents: 5332944, 5361215, 5550753, 5559720, 5,883,459, 6253227, 6282370, 6590188, 6979052, 6958115, 7030343, 7,417,834 b2, Canadian Patent: 2342014, Australian patent: 2373248 other patents both foreign and domestic applied for and pending. All material copyright of Balboa Water Group.



Reminder Messages (Continued)

CHNG. CART.

Alternates with temperature or normal display.

As needed.

Install new mineral cartridge.

CHEK. OZ.

Alternates with temperature or normal display.

Appears on a regular schedule, e.g. every 365 days.

Check your ozone and/or UV generator per your spa manufacturer's instructions.

SRVC. CHEK.

Alternates with temperature or normal display.

Appears on a regular schedule, e.g. every 365 days.

Have a service technician do a check-up on your spa per your spa manufacturer's instructions.

Manufactured under one or more of these patents. U.S. Patents: 5332044, 5361215, 5550753, 5559720, 5,883,450, 6253227, 6282370, 6590188, 6970052, 6965815, 7030343, 7,417,834 b2, Canadian Patent: 2342614, Australian patent: 2373248 other patents both foreign and domestic applied for and pending. All material copyright of Balboa Water Group.

BALBOA
water group

Warning! Qualified Technician Required for Service and Installation

Basic Installation and Configuration Guidelines

Use minimum 6AWG copper conductors only.

Torque field connections between 21 and 23 in lbs.

Readily accessible disconnecting means to be provided at time of installation.

Permanently connected.

Connect only to a circuit protected by a Class A Ground Fault Circuit Interrupter (GFCI) or Residual Current Device (RCD) mounted at least 5' (1.52M) from the inside walls of the spa/hot tub and in line of sight from the equipment compartment.

CSA enclosure: Type 2

Refer to Wiring Diagram inside the cover of the control enclosure.

Refer to Installation and Safety Instructions provided by the spa manufacturer.

Warning: People with infectious diseases should not use a spa or hot tub.

Warning: To avoid injury, exercise care when entering or exiting the spa or hot tub.

Warning: Do not use a spa or hot tub immediately following strenuous exercise

Warning: Prolonged immersion in a spa or hot tub may be injurious to your health

Warning: Maintain water chemistry in accordance with the Manufacturer's instructions.

Warning: The equipment and controls shall be located not less than 1.5 meters horizontally from the spa or hot tub.

Warning! GFCI or RCD Protection.

The Owner should test and reset the GFCI or RCD on a regular basis to verify its function.

Warning! Shock Hazard! No User Serviceable Parts.

Do not attempt service of this control system. Contact your dealer or service organization for assistance. Follow all owner's manual power connection instructions. Installation must be performed by a licensed electrician and all grounding connections must be properly installed.

CSA Compliance/Conformité

Caution:

- Test the ground fault circuit interrupter or residual current device before each use of the spa.
- Read the instruction manual.
- Adequate drainage must be provided if the equipment is to be installed in a pit.
- For use only within an enclosure rated CSA Enclosure 3.
- Connect only to a circuit protected by a Class A ground fault circuit interrupter or residual current device.
- To ensure continued protection against shock hazard, use only identical replacement parts when servicing.
- Install a suitably rated suction guard to match the maximum flow rate marked.

Warning:

- Water temperature in excess of 38°C may be injurious to your health.
- Disconnect the electrical power before servicing.

Attention:

- Toujours vérifier l'efficacité du disjoncteur différentiel avant d'utiliser différentiel avant d'utiliser le bain.
- Lire la notice technique.
- Lorsque l'appareillage est installé dans une fosse, on doit assurer un drainage adéquat.
- Employer uniquement à l'intérieur d'une clôture CSA Enclosure 3.
- Connecter uniquement à un circuit protégé par un disjoncteur différentiel de Class A.
- Afin d'assurer une protection permanente contre le danger de choc électrique, lors de l'entretien employer seulement des pièces de rechange identiques.
- Les prises d'aspiration doivent être équipées de grilles convenant au débit maximal indiqué.

Avertissement:

- Des températures de l'eau supérieures à 38°C peuvent présenter un danger pour la santé.
- Déconnecter du circuit d'alimentation électrique avant l'entretien.

Warning/Advertissement:

- Disconnect the electric power before servicing. Keep access door closed.
- Déconnecter du circuit d'alimentation électrique avant l'entretien. Garder la porte fermée.

Manufactured under one or more of these patents: U.S. Patents: 5332944, 5361215, 5590753, 5596720, 5,883,459, 6253227, 6082370, 6590188, 6976052, 6955815, 7030343, 7,417,834 BC, Canadian Patent: 2342814, Australian patent: 2373248 other patents both foreign and domestic applied for and pending. All material copyright of Balboa Water Group.

42355 rev B

15

BALBOA
water group

10/30/20

UNLESS YOU HAVE THE APPROPRIATE ELECTRICAL LICENCE DO NOT OPEN THE SPAS COMPUTER BOX, PLEASE CONTACT THE STORE OF PURCHASE FOR DETAILS OF A LICENCED CONTRACTOR.

If you have any issue with your spa and the troubleshooting does not resolve your issue, please contact the store of purchase before engaging a technician or electrician for help. We will arrange a time for one of our technicians to be available to assist your technician or electrician with phone advice. Failure to do so may lead to your technician or electrician not being able to find or fix the fault leading to further unnecessary call outs to your site.