

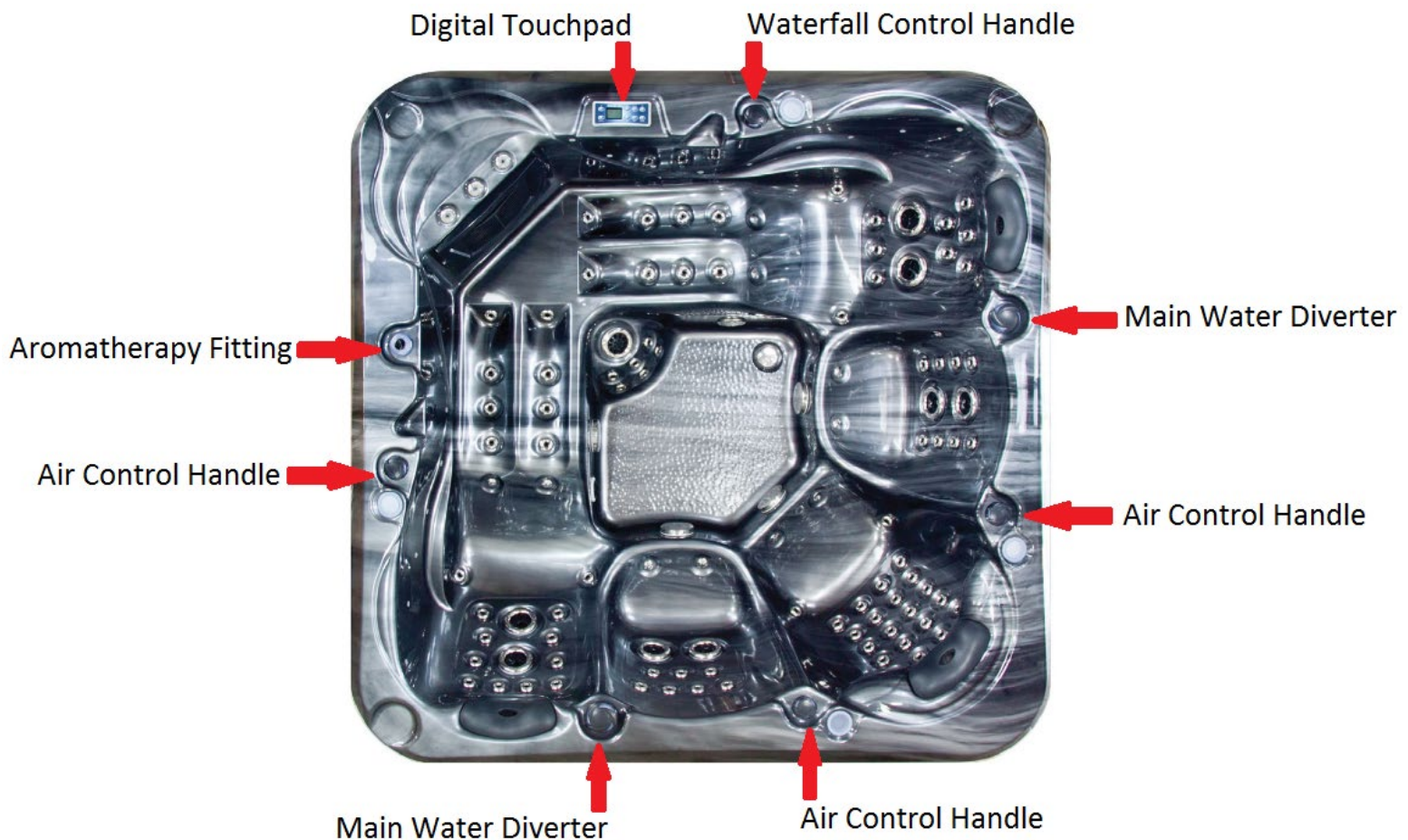

Noosa Luxury Spa

USER MANUAL



Contents:

3	Important safety instructions
3	Warnings
4	Hyperthermia
4	Considerations required for the location of your spa
4	Spa foundation
4	Water supply
5	Electrical safety
5	Electrical installation
5	Electrical connection point location
6-17	GS523DZ Tech Sheet
18	Important usage warnings – non warranty faults
18	Water treatment
19	How to remove your spas filters
19	Weekly filters cleaning
19	Filing your spa with water – avoiding air locks
20	Vinyl cover Installation
20	Vinyl cover use & care
20	Cabinet care
20	Acrylic shell care
21	Empty spa warning
21	Draining the spa – using the drain fitting
22	Turning jets on & off
22	Waterfall control handle
22	Air control handle
22	Main diverter handle
22	Aromatherapy control handle
22	Frost prevention system
22	Ozonator
23	Operating your Noosa Luxury Spa
24	Troubleshooting

IMPORTANT SAFETY INSTRUCTIONS

Your physiological response to hot water is very subjective and depends on your age, health and medical history. If you don't know your tolerance to hot water or experience dizziness, headaches, or nausea you should exit the spa immediately and cool down.

WARNINGS

Children in and around the spa should be supervised at all times by a responsible adult.

- Use caution when entering or exiting the spa, where practical install a safety grab bar or handrail and set of stairs with non-slip tape on the stair treads (cease use of the stairs immediately if the non-slip tape is not intact). Turn off all the jets before entering or exiting the spa to improve visibility while entering or exiting the spa. Remember that wet surfaces can be slippery.
- Do not allow anyone to submerge their head under the water.
- Do not use the spa unless all suction guards are installed to prevent body and hair entrapment. Do not sit in front of or on top of the suction fittings or skimmer. This will obstruct proper circulation of the water and may result in personal injury.
- Never operate the spa pumps without having all suction and return lines open.
- Always keep the vinyl cover installed and locked when the spa is not in use.
- Never allow anyone to sit or stand on the vinyl cover.
- People using medications and or having any adverse medical history should consult a physician before using the spa.
- People with infectious diseases should not use the spa.
- Do not use the spa if you are under the influence of alcohol or drugs.
- Do not consume alcohol or drugs while using the spa.
- Pregnant women should consult a physician before using the spa.
- As prolonged immersion in water temperatures more than 38°C (100°F) may damage your health, we recommend measuring the water temperature with an accurate thermometer before entering the spa. We also recommend establishing lower temperatures and shorter periods of use for users who may be affected by hot water temperature.
- To avoid the possibility of hyperthermia (heat stress) occurring it is recommended that the average temperature of spa-pool water should not exceed 38°.
- Do not use the spa immediately following strenuous exercise.
- You must use a Licenced Electrical Contractor to connect the spa to power.
- The power must be supplied through a residual current device (RCD) to Australian Standards.
- If your power supply cable is damaged switch the spa off at the residual current device inside yourhouses meter box, contact a Licenced Electrical Contractor to replace the cable.
- Live parts and connections must be inaccessible to any person in the spa.
- Earthed appliances must be permanently connected to fixed wiring.
- Do not permit or use electric appliances (such as lighting, telephone, radios, televisions etc.) within 2 meters of the spa.
- Test the GFCI (Ground Fault Circuit Interrupter) or residual current device (RCD) monthly.
- If water is leaking from the spa stop using the spa and turn it off at the residual current device (RCD) in the meter box until a qualified technician has resolved the problem.
- In daylight hours do not leave the spa empty or partially empty of water for any period of time, this can cause terminal damage to the spa fibreglass shell & acrylic layer.
- Post emergency phone numbers for Police, Fire Department and Ambulance at the nearest phone.
- Install a CPR Resuscitation chart within easy view of the spa.
- Check with your local council to see if you require a building & fencing permit for your spa.

HYPERTHERMIA

Since your spa can be set to reach temperatures of 40°C (104°F) users should be aware that extended submersion in water that exceeds normal body temperature can lead to hyperthermia. Hyperthermia occurs when the internal temperature of the body reaches several degrees above the normal body temperature of 37°C (98.6°F). The symptoms of hyperthermia include drowsiness, lethargy, and an increase in the internal temperature of the body. The effects of hyperthermia include:

- Unawareness of impending hazard.
- Failure to perceive heat.
- Failure to recognize the need to exit the spa.
- Physical inability to exit the spa.
- Foetal damage in pregnant woman.
- Unconsciousness resulting in the danger of drowning.

If you feel any of the symptoms of hyperthermia safely exit the spa immediately. Please note that the use of Alcohol, Drugs or Medication can significantly increase the risk of Hyperthermia.

CONSIDERATIONS REQUIRED FOR THE LOCATION OF YOUR SPA

Contact your local council to determine if a building permit is necessary and for information on applicable bylaws (distance from property lines, buildings, fencing requirements etc.). If you are doing any excavating contact Dial before You Dig on 1100 to ensure that there are no underground lines.

Locate the spa where possible within close distance of a door to the house, this will maximize potential winter use. If possible, locate the spa where you will enjoy some privacy. Make sure your spa is positioned so that access to all cabinet panels will not be blocked. Blocking access to any cabinet panel on the spa will render the spa unserviceable, you must have 900mm of clear uninterrupted space on all sides of the spa for a service technician to have space to make repairs. Service technicians will not move your spa to gain access to a cabinet panel which has been blocked in. Decking in your spa is not recommended you may render your spa unserviceable if the entire deck is not easily removable. Our technicians will not remove your deck to service your spa.

SPA FOUNDATION

Your spa needs a good solid foundation supporting the whole base of the spa. The foundation on which your spa sits must be able to support the weight of the spa the water in it and the weight of its users. If the foundation is inadequate the spa may shift, this will cause stress to the spa shell which may lead to the shell cracking. Damage caused by an inadequate or improper foundation is not covered under this warranty. It is the responsibility of the spa owner to provide a proper foundation for the spa. A spa containing both water and people is extremely heavy, if you are installing the spa onto decking or any other elevated structure you must consult a structural engineer to ensure that the structure will support the weight of the spa. Ideally the spa should be installed onto a concrete base at least 4" thick with reinforcing steel inside the concrete. If you are installing your spa indoors ensure that your choice of flooring is impermeable to water. Ensure that water drains away from the spa protecting the cabinet and electrical components from water damage. Do not place any item underneath the spas base to level the spa this will cause stress to the spa shell which may lead to the shell cracking. Damage caused by packing under the spas fibreglass base is not covered under this warranty.

WATER SUPPLY

Spas do not require a permanent water supply however there must be a water supply and hose within reach to fill the spa.

ELECTRICAL SAFETY

Do not place your spa within 3 metres of overhead power lines.

In case of an emergency, you must have an accessible power shut off point within 3 meters of the spa.

ELECTRICAL INSTALLATION

You will need a suitable electrical supply to run the spa. The Noosa Luxury Spa requires a hardwired 32Amp Residual Current Device Protected Dedicated Power Connection. Your Licenced Electrical Contractor can hardwire the spa straight to the meter box in your house or they can install a hardwired 32Amp residual current device protected dedicated isolation switch. Page 8 in this manual listed as “As Manufactured” will show your electrician the wiring required.

ELECTRICIANS PLEASE NOTE: DO NOT CHANGE the DIP switches.

ALL ELECTRICAL CONNECTIONS REQUIRE YOUR LICENCED ELECTRICAL CONTRACTOR TO INSTALL THE APPROPRIATE SIZED RCD IN THE HOUSES METER BOX.

It is the responsibility of your Licenced Electrical Contractor to ensure the Residual Current Device is installed at the correct mA required by the law.

When appointing an electrician to prepare your spas electrics check that they are suitably qualified and licenced to do so. Do not attempt to install the spas electrics yourself if you are not a fully Licenced Electrical Contractor. The spa must be wired on its own fused circuit back to your household meter box. The spa should not be sharing power supply with any other appliances.

We recommend you install a hardwired 32Amp residual current device protected dedicated Rotary Isolation Switch so that the spa can be isolated from the power supply in an emergency or for service work. This is simply a rotary on/off switch but should be sited more than 2 metres away from the spa so that users cannot be in the spa whilst operating the switch.



Rotary Isolation Switch

ELECTRICAL CONNECTION POINT LOCATION



To hardwire the spa your Licenced Electrical Contractor will locate the electrical connection point here, unscrew and remove the cabinet panels directly underneath the spas touch pad. While your electrician is on site make sure all the pumps are running before they leave site.

GS523DZ Tech Sheet

Balboa System PN 54763-01

System Model # GS5-GS523DZ-RCA-3.0

Software Version # 43

EPN # 2808

Base PCBA - PN 55857-01

PCB GS500Z - PN 22015 Rev B

Base Panels

VL801D (Serial Deluxe) – PN 54121

VL802D – PN 54562



Template used: 40599_97_0.pdf 11/08/2008
54763-01_97_D.pdf 03/17/2009

BALBOA
water group

System Revision History

System PN	EPN	Date	Requested By	Changes Made
54763-01	2808	02.10.2009	Balboa	Update software to version 43.
54763-01	2808	03.17.09	Balboa	Update Tech Sheet Electrical Service Config Pages

Basic System Features and Functions

Power Requirements

Single Service [3 wires (line, neutral, ground)]

- 230VAC, 50Hz, 1~, 32A, (Circuit Breaker rating = 40A max.)

Dual Service [5 wires (line 1, neutral 1, line 2, neutral 2, ground)]

- 230VAC, 50Hz, 1~, 2x 16A, (Circuit Breaker rating = 20A max each service.)

3-Phase Service [5 wires (line 1, line 2, line 3, neutral, ground)] **Requires PCB Rev B.**

- 400VAC, 50Hz, 3N~, 16A, (Circuit Breaker rating = 20A max each phase line.)
- **IMPORTANT** - Service must include a neutral wire, with a line to neutral voltage of 230VAC.

System Outputs

Setup 1 (As Manufactured)

- 230V Pump 1, 2-Speed
- 230V Pump 2, 1-Speed
- 230V Pump 3, 1-Speed
- 230V Blower
- 230V Ozone
- 10V Spa Light
- 230V AV (Stereo)
- 3.0kW Heater *

Setup 2

- 230V Pump 1, 2-Speed
- 230V Pump 2, 1-Speed
- 230V Pump 3, 1-Speed
- 230V Blower
- 230V Ozone
- 230V Circ Pump
- 10V Spa Light
- 230V AV (Stereo)
- 3.0kW Heater *

* Heater wattage is rated at 240V.

Additional Options

- Full Feature Dolphin Remote and Spa-only Dolphin Remote
- IR Receiver Module
Connects to terminal J1 or J2
(Must be 8-pin connector)
- MoodEFX Lighting
Connects to Spa Light terminal J20
- FiberEFX Lighting
Connects to Spa Light terminal J20

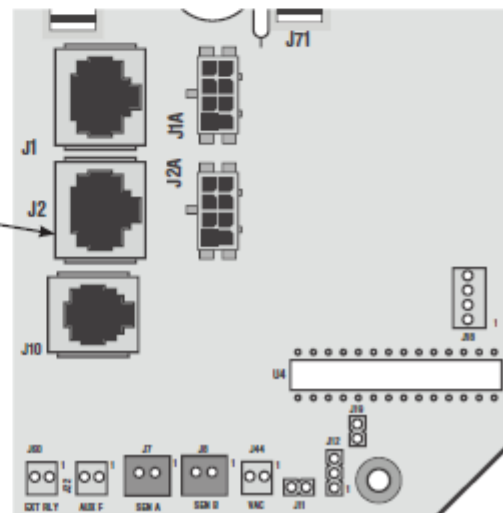

Basic System Features and Functions

Any time you change a DIP Switch, other than A1, you must reset Persistent Memory for your new DIP Switch Settings changes to take effect. If you do not reset Persistent Memory, your system may function improperly.

To reset Persistent Memory:

- Power down by disconnecting power source from spa.
- Put a jumper across J43, covering both pins. (See illustration below)
- Power up by connecting power source to spa.
- Wait until "Pr" is displayed on your panel.
- Power down again.
- Remove jumper from J43 (May also move to cover 1 pin only)
- Power up again.

About Persistent Memory and Time of Day Retention:

This system uses memory that doesn't require a battery to store a variety of settings. What we refer to as Persistent Memory stores the filter settings, the set temperature, and the heat mode.

Persistent Memory is not used for Time of Day. Only models with a Serial Deluxe panel installed (VS5xxDZ and GS5xxDZ) can display the time. However, during power loss to the spa, the system will lose the correct time, and reset to 12:00 PM when power is restored.

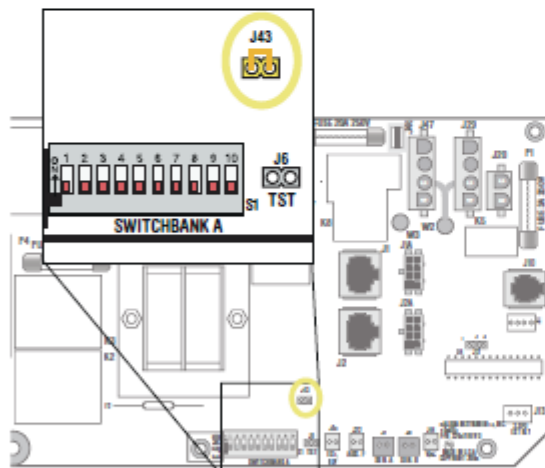

J43 on VS5xxZ and VS300 Series Main Board Shown.

J43 on GS5xxZ Series is located in approximately the same position.

Power Up Display Sequence

Upon power up, you should see the following on the display:

- Three numbers in a row, which are the SSID (the System Software ID). The third display of these numbers is the Software Version, which should match the version of your system. For example, if these three numbers are 100 6 7 38, that is a VS511SZ at version 38.
- Displayed next is: "24" (indicating the system is configured for a heater between 3 and 6 kW) or "12" (indicating the system is configured for a heater effectively* between 1 and 3 kW). "24" should appear for all VS models running at 240VAC. "12" should appear for all VS models running at 120VAC, as well as all GS models. (*A heater which is rated at 4 kW at 240VAC will function as a 1 kW heater at 120VAC.)
- "Pr" will appear to signal the start of Priming Mode.

At this point, the power up sequence is complete. Refer to the Reference Card for the VS or GS System model of your spa for information about how the spa operates from this point on, including how to adjust the Time of Day if using a Serial Deluxe style panel.

Wiring Configuration and DIP Settings

Setup 1 (As Manufactured)

- 230V Pump 1, 2-Speed
- 230V Pump 2, 1-Speed
- 230V Pump 3, 1-Speed
- 230V Blower
- 230V Ozone
- 10V Spa Light
- 230V AV (Stereo)
- 3.0kW Heater
- Deluxe Main Panel

HiPot Testing Note:

Disconnect slip terminal with green wires from J90 prior to performing HiPot test. Failure to disconnect may cause a false failure of the test. Reconnect terminal to J90 after successful completion of HiPot test.

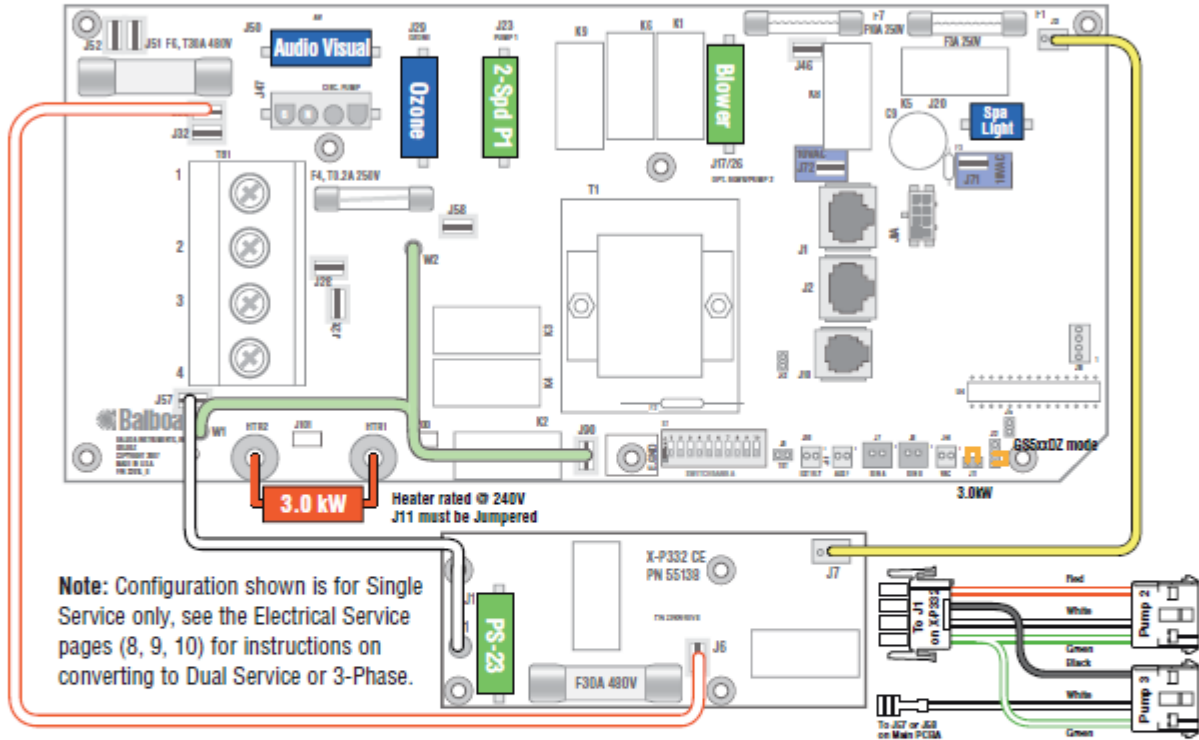

WARNING: Main Power to system should be turned OFF BEFORE adjusting DIP switches.
WARNING: Persistent Memory (J43) must be RESET to allow new DIP switch settings to take effect. (See Persistent Memory page)

SSID # 100 91 43	Switchbank A 	GSS23DZ Software 	Wiring Color Key <ul style="list-style-type: none"> Neutral (Common) AC Connections Special AC Connections Line AC Connections 10 Volt Connections Relay Control Wires
	A1, Test Mode OFF A2, See Table 1 A3, N/A A4, Aux Freeze A5, 2-speed P1 A6, 50 Hz A7, J17/26 Enabled A8, Degrees C A9, Non-Circ Mode A10, See Table 1	J11 3.0kW Heater	
Panel Button Assignments 1=Time 5=Light 2=Mode/Prog 6=Pump 1 3=Temp Up 7=Pump 2 4=Temp Down 8=J17/26	Panel Button Positions 	Board Connector Key 1 Typically Line voltage 2 Typically Line voltage for 2-speed pumps 3 Neutral (Common) 4 Ground Note flat sides in connector	

Wiring Configuration and DIP Settings

Setup 2

- 230V Pump 1, 2-Speed
- 230V Pump 2, 1-Speed
- 230V Pump 3, 1-Speed
- 230V Blower
- 230V Ozone
- 230V Circ Pump
- 10V Spa Light
- 230V AV (Stereo)
- 3.0kW Heater
- Deluxe Main Panel

HiPot Testing Note:

Disconnect slip terminal with green wires from J90 prior to performing HiPot test. Failure to disconnect may cause a false failure of the test. Reconnect terminal to J90 after successful completion of HiPot test.

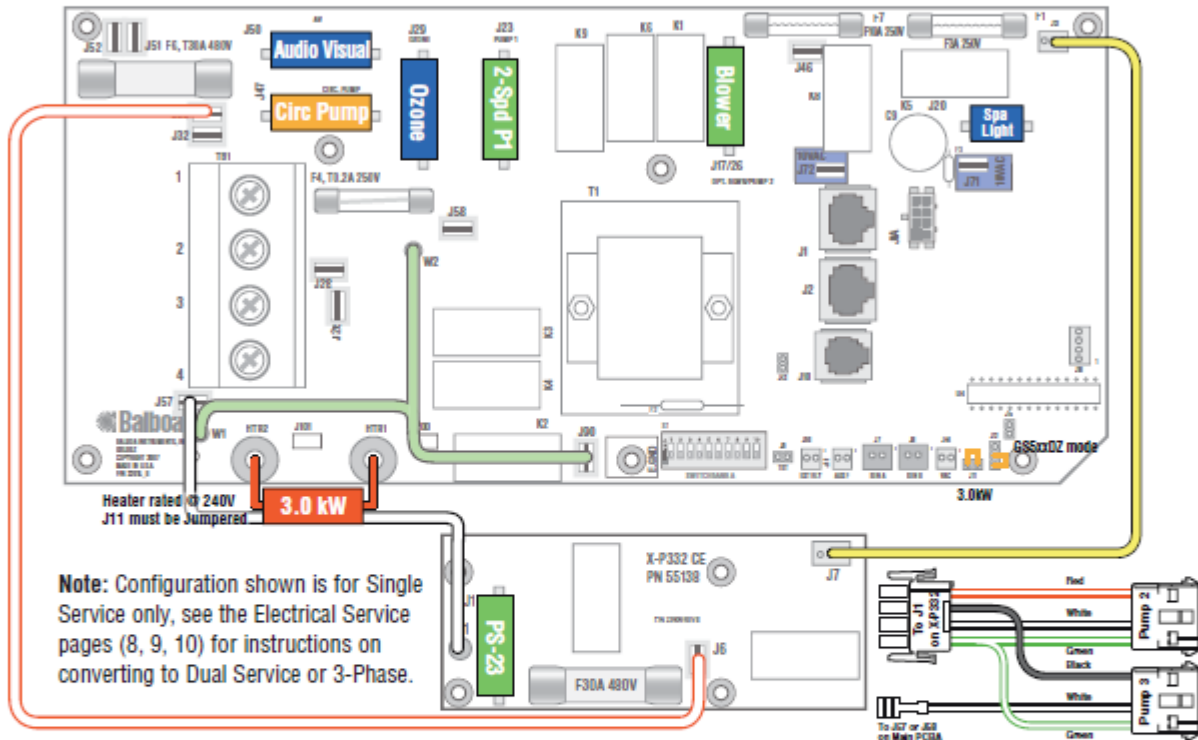

WARNING: Main Power to system should be turned OFF BEFORE adjusting DIP switches.
WARNING: Persistent Memory (J43) must be RESET to allow new DIP switch settings to take effect. (See Persistent Memory page)

SSID #

100
91
43

Switchbank A

A1, Test Mode OFF
A2, See Table 1
A3, N/A
A4, Aux Freeze
A5, 2-speed P1
A6, 50 Hz
A7, J17/26 Enabled
A8, Degrees C
A9, 24 Hour 3°F Circ Pump
A10, See Table 1

Wiring Color Key

- Neutral (Common) AC Connections
- Special AC Connections
- Line AC Connections
- 10 Volt Connections
- Relay Control Wires

Panel Button Assignments

1=Time 5=Light
2=Mode/Prog 6=Pump 1
3=Temp Up 7=Pump 2
4=Temp Down 8=J17/26

Panel Button Positions

Board Connector Key

1 Typically Line voltage
2 Typically Line voltage for 2-speed pumps
3 Neutral (Common)
4 Ground

Note flat sides in connector

DIP Switches and Jumpers Definitions

SSID 100 91 43

Base Model GS523DZ

DIP Switch Key

- A1 Test Mode (normally OFF)
- A2+A10 Control amp draw requirements (See Table 1)
- A3 N/A (must be OFF)
- A4 Aux Freeze (must be OFF)
- A5+A9 Pump 1 speeds and Circ Modes:

A5	A9	Circ Mode	Pump 1 Speed
OFF	OFF	Non-circ	2-speed
ON	OFF	Circ 'acts like Pump 1 low' (filters/polls/ect)	1-speed
OFF	ON	24 hours with 3°F shut-off	1-speed
ON	ON	24 hours with 3°F shut-off	2-speed

- A6 "ON" position: 50Hz operation
"OFF" position: 60Hz operation
- A7 "ON" position: J17/26 Enabled for Blower or 1-speed Pump 4.
"OFF" position: J17/26 Disabled.
- A8 "ON" position: temperature is displayed in degrees Celsius
"OFF" position: temperature is displayed in degrees Fahrenheit

Table 1 # of Hi-Speed Pumps/Blower Before Heat Disabled

A2	A10	
OFF	OFF	0
ON	OFF	1
OFF	ON	2
ON	ON	3

Alert:

Pump 2 and Pump 3 are required, use X-P332 CE expander board with PS-23 splitter cable. To add Blower or 1-speed Pump 4, use J17/26.

Jumper Key

- J11** If using 3kW or higher wattage heater, jumper can be set in either position, but may perform better on Pins 1 and 2. If using 2.5kW or lower wattage heater, jumper must be set on 1 Pin only.
- J12** **Factory set. DO NOT MOVE.**
Jumper must be on Pins 1 and 2 for GS51xZ/GS52xZ/GS5xxSZ/GS5xxDZ software.
Jumper must be on Pins 2 and 3 for GS50xZ software.
- J43** When jumper is placed on 2 pins during power-up, system will reset persistent memory. Leave on 1 pin only to enable persistent memory feature.

WARNING:

- Setting DIP switches incorrectly may cause abnormal system behavior and/or damage to system components.
- Refer to Switchbank illustration on Wiring Configuration page for correct settings for this system.
- Contact Balboa if you require additional configuration pages added to this tech sheet.

Panel Button Positions



Panel Button Assignments

- | | |
|-------------|--------------------------|
| 1=Time | 5=Light |
| 2=Mode/Prog | 6=Pump 1 |
| 3=Temp Up | 7=Pump 2+Pump 3 |
| 4=Temp Down | 8=J17/26 (when A7 is ON) |

Aux Panel Information

Supports 2-button aux panel



Supports 4-button aux panel



Electrical Service Configuration Options

Systems with PCB Rev B Only

AS MANUFACTURED

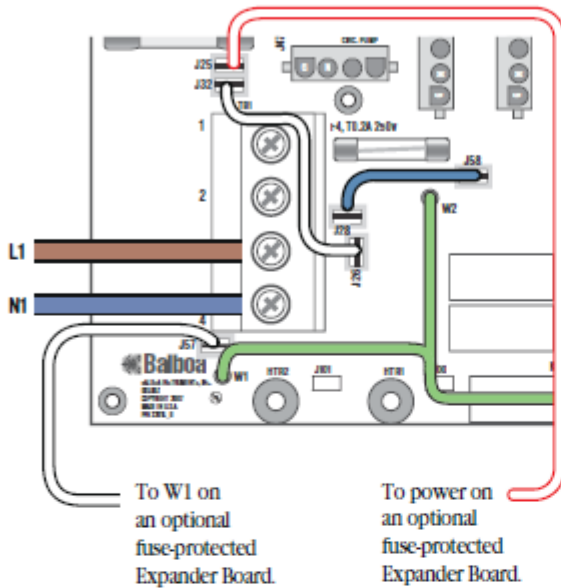

Single Service, TN and TT Electrical Systems (1 x 32 Amp)

3 Wires (1 Line + 1 Neutral + 1 Protective Earth)

Protective Earth wire (Green/Yellow) must be connected to system ground terminal as marked.

This option is configured and shipped as the default.

All equipment (pumps, blower, heater and any expander board) runs on service line L1.

Systems using only 1 DIP switch (A10) for heat disable:
1 x 16 Amp Service is not supported:

For 1 x 32 Amp Service:

Set DIP Switch A10 such that total system amperage draw never exceeds rated service input.

Systems using multiple DIP switches for heat disable:

Refer to system Hot Sheet DIP Switch Definition page

and set the switches shown in Table 1 such that total

system amperage draw never exceeds rated service input.

OPTIONAL

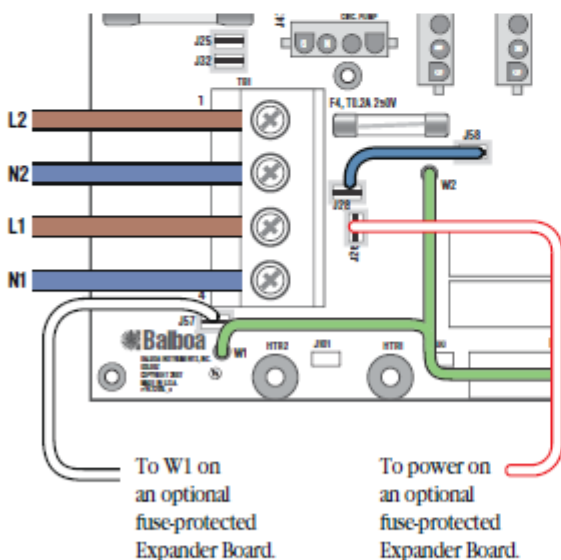

Dual Service, TN and TT Electrical Systems (2 x 16 Amp)

5 Wires (2 Lines + 2 Neutrals + 1 Protective Earth)

Protective Earth wire (Green/Yellow) must be connected to system ground terminal as marked.

The heater and any expander board run on service line L1, while all other equipment, such as pumps and blowers, run on service line L2.

Completely remove the white wire from J26 and J32.

Note: J32 and J25 are electrically identical. The white wire may be attached to either terminal before removal.

Systems using only 1 DIP switch (A10) for heat disable:
DIP Switch A10 must be OFF.

Systems using multiple DIP switches for heat disable:

Refer to system Hot Sheet DIP Switch Definition page

and set both switches shown in Table 1 to ON positions.

If using an Expander Board:

Systems using multiple DIP switches for heat disable:

Refer to system Hot Sheet DIP Switch Definition page

and set both switches shown in Table 1 to OFF positions.

Electrical Service Configuration Options

Systems with PCB Rev B Only

OPTIONAL

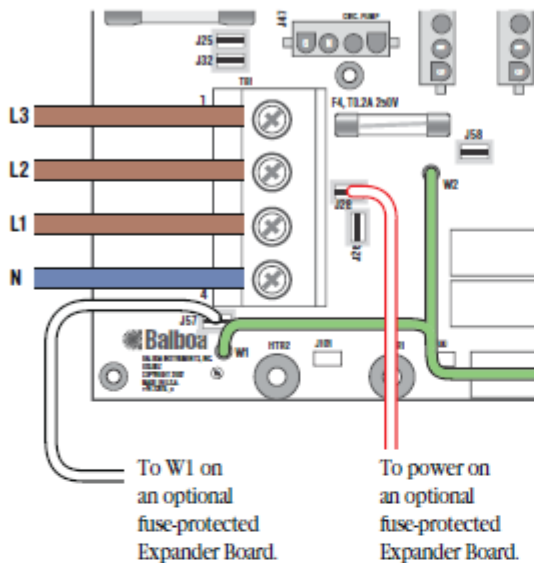

3-Phase Service, TN and TT Electrical Systems 5 Wires (3 Lines + 1 Neutral + 1 Protective Earth)

Protective Earth wire (Green/Yellow) must be connected to system ground terminal as marked.

IMPORTANT - Service **MUST** include a neutral wire, with a line to neutral voltage of 230VAC.

The heater runs on service line L1.

All main-board equipment run on service line L3. Additional equipment, such as expansion boards, run on service line L2.

Completely remove the white wire from J26 and J32, or J25.

Completely remove the blue wire from J28 and J58.

Systems using only 1 DIP switch (A10) for heat disable: DIP Switch A10 must be OFF.

Systems using multiple DIP switches for heat disable:

Refer to system Hot Sheet DIP Switch Definition page and set both switches shown in Table 1 to ON positions.

NOTE:

- Not all GS5xxZ systems can support 3-Phase.
- 3-Phase requires System PCB Rev B.
- If using an expansion board, the board must have fuse-protection.

Electrical Service Application Notes

*This page is specific to the GS523DZ model with 7A max pumps.
(The preceding pages cover all possible GS applications.)*

As manufactured, this system comes configured for Single Service.
See the preceding pages for instructions on moving wires for Dual Service or Three-Phase configurations.

Use the following guidelines for setting DIP Switches appropriately for the particular service configuration chosen.

For 1x16A Service:

Not Supported.

For 1x32A Service:

Switch A2 must be OFF and A10 can be ON.

For 2x16A Service:

Switches A2 and A10 must be OFF (because Pumps 2 and 3 are on the same service as the Heater).

For 3-phase Service (16A per phase):

Pump 1 and blower are on one phase, Pumps 2 and 3 are on another phase, and the Heater is on its own phase. So there are no limitations needed on equipment running together. Thus switches A2 and A10 can both be ON.

Ozone Connections

Note: A special tool is required to remove the pins from the connector body once they are snapped in place. Check with your Balboa Account Manager for information on purchasing a pin-removal tool.

Balboa Ozone connector configuration for 230VAC 50Hz:

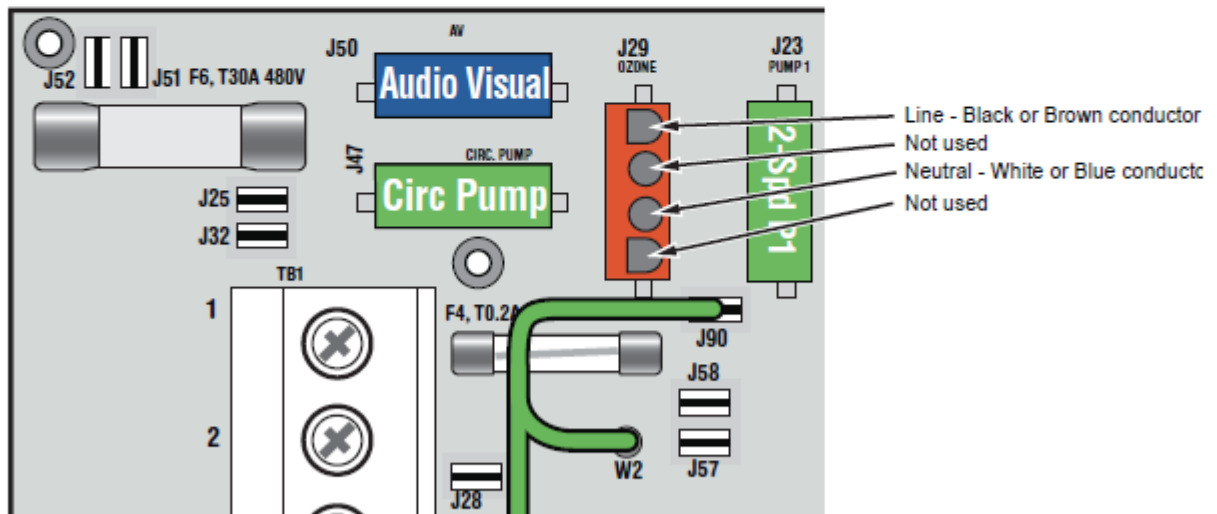
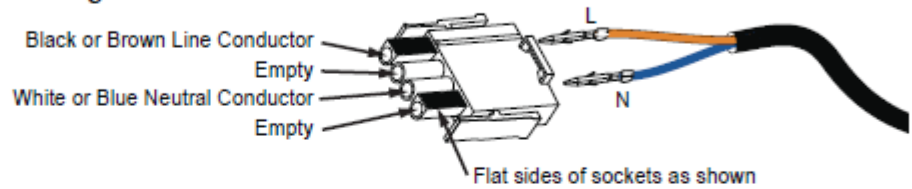

Serial Deluxe Panel Configurations

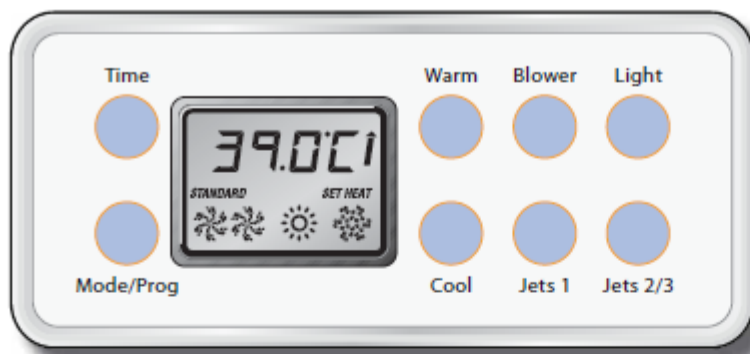

VL801D (Serial Deluxe)

PN 54121 no Overlay

- Connects to Main Board terminal J1 only*

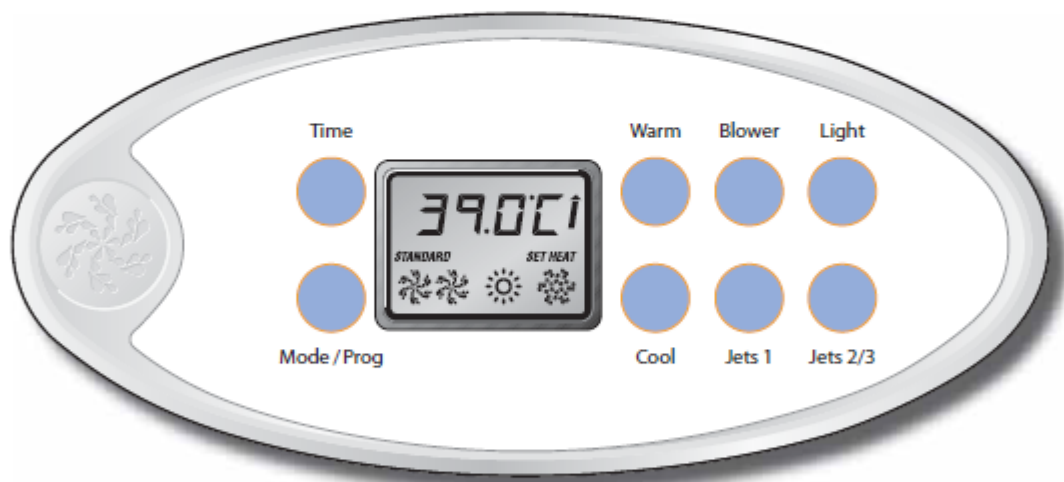

VL802D

PN 54562 no Overlay

- Connects to Main Board terminal J1 only*

* Panels with back-lighting (bulbs installed) should never be plugged into J2. Use J1 only.
If the backlight bulbs are removed, then both J1 and J2 may be used.

IMPORTANT USAGE WARNINGS – NON WARRANTY FAULTS

Spas are extremely delicate products and require regular maintenance. Below we will list a number of common causes of problems which are not covered under this warranty. Should we ever need to visit you to repair your spa you will be charged the full cost of a repair if we found that the cause was the result of poor maintenance or customer negligence. Paying full attention to the issues below will help to reduce the risk of damage to your spa.

WATER TREATMENT

The most crucial aspects of spa maintenance is water treatment. Improper water balance will cause damage to the spas fibreglass shell, acrylic shell, pumps, jets, heater, headrests, vinyl cover and fittings. If we find improper water balance in your spa, these parts will not be covered under this warranty.

Please note that your spas headrests and filter box face are sensitive to chemical exposure, they will eventually discolour and turn white. If you over sanitize the water or allow them to float in the water, this can happen immediately. Discoloured headrests and filter box faces will not be covered under this warranty. Do not clean the spas headrests or filter box face with the spas water only use fresh tap water to clean the headrests and filter box faces.

We recommend that you have the spa water tested weekly at a professional pool or spa store to gain accurate results of the water chemistry. When you test at other pool or spas stores, you can use the test results they give you to calculate any adjustments you need to make using our how to balance the water instructions. You do need to be careful to not just apply the amounts of chemical that they tell you to apply. The reason for this is that they might set the parameters differently to what your spa requires.

Water chemistry test history from a professional pool or spa store showing results for Free chlorine, Total chlorine, pH, Alkalinity, Calcium hardness, Cyanuric acid & Salt must be kept as a dated once-a-month digital reference as part of your warranty terms. This test history will be required in the event of a warranty claim. Your warranty will be made void if you cannot show these results, or these results show you have used chemicals with ingredients we have asked you not to use or the results show you have not maintained the water to the ideal readings we have provided you with.

CHEMICALS WITH ANY OF THESE INGREDIANTS CANNOT BE USED IN YOUR SPA.

Bromine, Granular chlorine calcium, Trichlor chlorine, Dichlor chlorine, Stabilised chlorine, Cyanuric acid, Liquid pool chlorine, Hydrochloric acid, Magnesium, Epsom salt, Hydrogen peroxide chlorine free, Phlihexanide hydrochloride chlorine free, Polyhexamethylene biguanide chlorine free.

THESE CHEMICALS ARE ALL KNOWN TO CAUSE SOME FORM OF DAMAGE TO FIBREGLASS - ACRYLIC SPAS.

SOME OF THESE CHEMICALS WILL BREAK DOWN THE BONDS OF THE FIBREGLASS – ACRYLIC SHELL WHICH ALLOWS THE FIBREGLASS – ACRYLIC SHELL TO BE RE SHAPPED. THE WEIGHT OF THE WATER WILL PUSH DOWN ON THE FIBREGLASS – ACRYLIC SHELL AND RESHAPE IT OVER THE STAINLESS-STEEL STRUCTURAL FRAME CAUSING THE STRUCTURAL FRAME TO BECOME VISABLE THROUGH THE SHELL. SOME OF THESE CHEMICALS WILL BREAK DOWN THE ACRYLIC SHELL CAUSING BUBBLES & HOLES IN THE ACRYLIC SHELL.

THESE ISSUES ARE IRREVERSABLE.

Your warranty will be made void if you use any of these chemicals, even if you only used it once.

If your monthly water test results show any amounts of these chemicals in your water, please contact your store of purchase immediately for advice.

HOW TO REMOVE YOUR SPAS FILTERS

Remove the flat head screw in the filter box face and dispose of it.

DO NOT REINSTALL THE SCREW.

1. Slide the face plate on the filter box vertically upwards until it separates away from the filter box.
2. Remove the leaf catcher by sliding it horizontally towards the centre of the spa.
3. To remove the filter, turn the handle on the top of the filter anti-clockwise until you can lift the filter out of the filter box.
4. To install the filter, place the filter inside the filter box and turn the handle on the top of the filter clockwise. Do not turn the filter with force just gently screw it in so it can be easily removed for weekly cleaning.
5. To install the leaf tray slide it horizontally into the filter box, make sure the tray sits in the middle of the locating grooves. The filter face plate will not install if you have the leaf tray outside of the locating grooves.
6. To install the face plate on the filter box slide the face plate vertically downwards.



Note:

The black filter face will go white where the water and air meets from chemical exposure. This is unpreventable and can occur very quickly if you over sanitize the water.

WEEKLY FILTERS CLEANING

Once a week remove the filters from the spa and wash thoroughly with a garden hose, then place the filters in a bucket of cold water and add 125ml of Filter Cleaner & Degreaser #9 or Filter Cleaner & Degreaser 1Litre Bottle. Agitate the water and leave the filters submerged to soak for 24 hours. After 24hours remove the filters, wash it thoroughly and allow it to completely dry out in an area exposed to the sun or wind.

It is recommended to purchase a spare filters and alternate between the filters each week to make the cleaning process easier. Filters which are not cleaned weekly can cause your spa to stop cleaning & heating. You filter needs to be replaced every twelve months, however if you are rotating between two filters this will require replacement every two years.

To order your replacement filters <https://www.aquapulsespas.com.au/products/universal-cartridge-filter-2>

FILLING YOUR SPA WITH WATER – AVOIDING AIR LOCKS

The correct way to fill your spa with water is to remove the spas filter and place your hose inside the filter box. Be sure to remove the fitting off the hose to prevent it from falling into the spas plumbing.

Placing the hose inside the spas main seating area may cause a build-up of air inside the plumbing creating an air lock. Air locks can stop the pumps and heater from working.

To help avoid this problem ensure you fill up the spa through the filter box. You can tell if you have an air lock by turning on the pumps, if no water appears to circulate through the system, it is very likely that you have an air lock. To resolve this problem, turn the pump off and loosen the unions at the side of the suction end of the pump until water begins to flow through, then retighten the union and try turning the pump on again.

Alternatively contact the store of purchase for advice on other ways to remove an air lock. Avoid over filling your spa with water.

Note:

Please ensure the drain fitting is closed before filling the spa with water, see instructions on page 20.



VINYL COVER INSTALLATION

Locate the screws and keys, which are packaged inside the vinyl cover.

Place the vinyl cover on top of the spa. Your vinyl cover is not square, you may need to rotate it to fit the spa.

On each strap of the vinyl cover there is a black plastic lock. Press the two prongs on each lock together and gently pull downwards to remove the section of the lock which you will need to screw onto the spas cabinet. With the section of the lock you have in your hand place it behind the prongs which are attached to the vinyl cover strap lined up so that the bottom of each part is flush. Now raise the section of the lock you have in your hand towards the top of the spa by 2cm and mark the position of the two holes on each lock onto the spas cabinet. Using the screws supplied screw each lock onto the spas cabinet. Do not pre-drill holes the screws will self-tap in, if using a drill stop before the screw is completely tight and finish tightening the screw by hand, if you over tighten the lock you will crack the plastic.

VINYL COVER USE & CARE

To lift the vinyl cover, place your hand underneath the valance and lift the vinyl cover itself. The handles & valance on the vinyl cover are not for lifting or pulling the vinyl cover, lifting or pulling on the handles or valance will tear the vinyl & stitching. Never stand, sit, or apply any weight to the vinyl cover this will bend or break the vinyl cover. Do not open the zippers on your vinyl cover they can be extremely difficult to close and may not close at all. To clean your vinyl cover wipe both the top vinyl and underside over with a damp fresh tap water cloth. Do not use the spas water to wipe the vinyl cover this will leave chemical stains on the vinyl. To extend the life expectancy of your vinyl cover apply 303 aerospace protectant to the vinyl side of your vinyl cover every 30 days and balance your spas water weekly as per the chemical instructions we have supplied you with. Poorly balanced water can blister your vinyl cover, breakdown the stitching & leave algae stains on the cover.

Your vinyl cover must always be locked to the spas cabinet when the spa is not in use. Leaving the vinyl cover off exposes your spa to the elements which can cause permanent damage to the spas acrylic shell and fittings, it also allows leaves, dust etc. to enter your spa. Debris in the spa can cause blockages or damage to the equipment.

CABINET CARE

Do not use any chemicals to clean your cabinet. The best way to clean your cabinet is to regularly wipe it down with a micro fibre cloth and fresh tap water. Where possible try to keep the cabinet from being exposed to the sun as this causes colour fade in the cabinet and can also cause the cabinet to warp.

ACRYLIC SHELL CARE

Once a week use a chemical free micro fibre cloth and wipe down the acrylic spa shell in and above the water line. The acrylic will show scratches, crazing and chaffing marks, this is unavoidable and is not a manufacturing fault it's normal wear and tear for acrylic.

EMPTY SPA WARNING

An empty or partially empty spa of water during daylight hours can cause deforming, changes to the shape of the shell, melting, crazing, discolouration, blisters or holes in the spa's fiberglass, acrylic and fittings, this can happen within minutes of the spa being emptied or partially empty. Your warranty does not cover deforming, changes to the shape of the shell, melting, crazing, discolouration, blisters or holes in the spa's acrylic and fittings, so it is especially important your vinyl cover is on the spa when not in use and the spa is filled with water at all times during daylight hours.

DRAINING THE SPA - USING THE DRAIN FITTING WARNING:

Never drain or partially drain your spa of water in daylight hours.

Always drain your spa at night time & fully refill your spa with water the same night.

An empty or partially empty spa of water during daylight hours can cause deforming, changes to the shape of the shell, melting, crazing, discolouration, blisters or holes in the spa's fiberglass, acrylic and fittings, this can happen within minutes of the spa being emptied or partially empty. Your warranty does not cover deforming, changes to the shape of the shell, melting, crazing, discolouration, blisters or holes in the spa's acrylic and fittings, so it is especially important your vinyl cover is on the spa when not in use and the spa is filled with water at all times during daylight hours.

To locate your drain fitting it will be found on the touchpad side of the spa in either the left or right hand corner of the black fibreglass base underneath the synthetic cabinet. When you want to operate the drain fitting turn the handle clockwise and at the same time pull the handle away from the spa to release it from the locking keyway. When the drain fitting is pulled fully away from the fibreglass base you can now unscrew and remove the handle by screwing it anticlockwise. With the handle off you can now connect the supplied hose connection and attach your garden hose, now push the drain halfway back in toward the fibreglass base and it will begin draining the spa. Once drained remove the garden hose and garden hose connection. Replace the handle by screwing it on clockwise and push the drain fitting back into the fibreglass base. Once in the fibreglass base slightly turn the handle which will prevent it from coming out when you refill the spa with water.

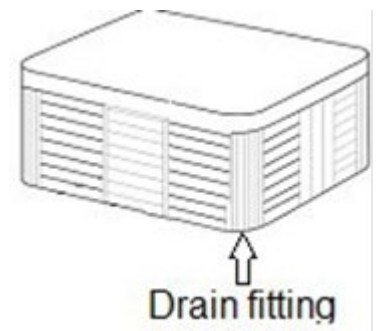

OPENING & CLOSING WATER JETS

The larger water jets in your spa can be manually turned on or off.

Turning the stainless-steel jet face clockwise will turn the jet on which will allow the water to flow through the jet.

Turning the stainless-steel jet face anticlockwise will turn the jet off slowing the water from flowing through the jet.

The smaller stainless-steel jets in your spa can not be opened & closed, they will always remain open.

WATERFALL HANDLE

Your waterfall handle can be located on the spa image on page one.

To run your waterfalls, turn on a water pump and turn the waterfall handle to the left.

To turn the waterfalls off turn the waterfall handle to the right.

Do not apply force to the handle at the fully open or fully closed positions you will break it if you do, turn it softly.

The waterfall handle must be in the closed position when the spa has its vinyl cover on.

AIR CONTROL HANDLES

The air control handles can be located on the spa image on page one.

These handles control the amount of air pressure the jets receive.

Turning the handle to the left will increase the water jets pressure.

Turning the handle to the right will decrease the water jets pressure.

AROMATHERAPY CONTROL HANDLE

Your spa has an inbuilt aroma therapy stick which can be located on the spa image on page one. With all the pumps turned off unscrew the fitting from the spa and take out the stick. Remove the plastic transport cover by unscrewing the blue cap and sliding the opaque cover off to expose the scented stick inside, screw the blue cap back onto the aroma stick leaving the opaque cover off. Reinstall the stick back into the spa, do not overtighten the fitting it only needs to be lightly tightened. Turning the handle clockwise runs the aroma scent when you have the air blower turned on and turning the handle anticlockwise will turn the aroma scent off.

WATER DIVERTER

The diverter handle can be located on the spa image on page one.

This handle is used to move where the water is delivered within the spa.

When you turn the handle to different positions the water pressure will change and move location within the spa.

When the pumps are running this handle will make loud noise from the water pressure flowing through the handle, the noise level will vary depending on where the handle is positioned.

Do not turn this handle while the pumps are running and do not apply force to the handle at the fully open or fully closed positions you will break it if you do, to make adjustments turn the handle softly when the pumps are turned off.

AROMATHERAPY CONTROL HANDLE

Your spa has an inbuilt aroma therapy stick which can be located on the spa image on page one. With all the pumps turned off unscrew the fitting from the spa and take out the stick. Remove the plastic transport cover by unscrewing the blue cap and sliding the opaque cover off to expose the scented stick inside, screw the blue cap back onto the aroma stick leaving the opaque cover off. Reinstall the stick back into the spa, do not overtighten the fitting it only needs to be lightly tightened. Turning the handle clockwise runs the aroma scent when you have the air blower turned on and turning the handle anticlockwise will turn the aroma scent off

MY SPA IS TOO HOT IN SUMMER, THE TEMPERATURE OF THE WATER IS HIGHER THAN I HAVE SET

During summer there may be times when the spas water exceeds the set temperature. This is not a fault in the spa it is simply the ambient air temperature causing this. To combat this problem, you can use ice to cool down the water.

FROST PREVENTION SYSTEM

If the temperature of the spas water drops below 5°C the spa will switch on the heater until the spa reaches the temperature of 8°C.

OZONATOR

The spas ozonator will automatically turns itself on when the spa is running filter cycles, there are no adjustments you are able to make. When the ozonator is running, the bubbles you see and the noise level you hear will vary. Sometimes you will see less bubbles and hear less noise, sometimes you will see more bubbles and hear more noise, this is normal operation and is not cause for concern.

Balboa 500DZ-Series Operation Guide

Initial Start-up

Your spa will enter Priming Mode (**Pr**) when it is energized. During Priming Mode, press “Jets” button(s) repeatedly and be sure all pumps are free of air. Priming Mode lasts less than 5 minutes. Press “Warm” or “Cool” to exit. After Priming Mode, the spa will run in Standard Mode (see Mode/Prog section).

The pump responsible for heating and filtration (pump 1 low-speed on non-circ system, or the circ pump on circ systems) will be referred to simply as the pump.

In multi-button sequences, if the buttons are pressed too quickly in the sequence, they may not register.

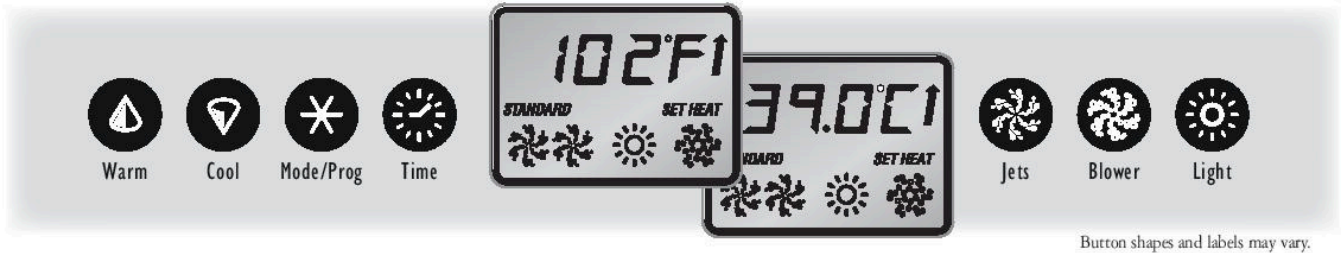

Temp Control (80°F - 104°F / 26.0°C - 40.0°C)

The last measured water temperature is constantly displayed.

The water temperature displayed is current only when the pump has been running for at least 2 minutes.

To display the set temperature, press “Warm” or “Cool” once. To change the set temp, press a temp button again before the display stops flashing. After three seconds, the display will stop flashing and begin to display the current spa temperature.

Jets 1

Press “Jets 1” to turn pump 1 on or off, and to shift between low and high speeds (if equipped). The low-speed will turn off after 4 hours. High-speed will turn off after 15 minutes. Low-speed may run automatically at times, during which it cannot be deactivated from the panel, but high-speed may be operated.

Jets 2/Jets 3/Blower (If equipped)

Press the corresponding button once to turn the device on or off. The device will turn off after 15 minutes. Pump 2 may be two-speed on some systems.

If the panel has a button with 2 devices assigned to it, like Pump 2 and Pump 3, press the button repeatedly to step through the various combinations of On and Off for both devices.

Light

Press “Light” to operate the spa light. Turns off after 4 hours.

Setting the Time of Day

When the spa is first powered up, the words **SET TIME** will flash on the display. Press “Time,” then “Mode/Prog,” then “Warm” or “Cool.” The time will begin changing in one-minute increments. Press “Warm” or “Cool” to stop the time from changing. Press “Time” to confirm.



This document covers VS and GS systems 500DZ through 520DZ with Balboa Panels VL801D or VL802D.
<http://www.balboawatergroup.com/>

Mode/Prog

Mode is changed by pressing “Warm” or “Cool,” then pressing “Mode/Prog” button.

Standard Mode maintains set temperature and the **STANDARD** icon will be displayed.

Economy Mode heats the spa to the set temperature only during filter cycles. **Ecn** will display when water temp is not current, and will alternate with water temp when the pump is running. The **ECONOMY** icon will be displayed.

Sleep Mode heats the spa to within 20°F/10°C of the set temperature only during filter cycles. **SLP** will display when water temp is not current, and will alternate with current water temp when the pump is running.

Preset Filter Cycles

The first preset filter cycle starts at 8:00 AM and ends at 10:00 AM. The second preset filter cycle starts at 8:00 PM and ends at 10:00 PM.

For non-circ systems, low-speed pump 1 and the ozone generator (if installed) run during filtration.

For 24 hour circulation systems, the circ pump and the ozone generator (if installed) run 24 hours. In hot environments, the circ pump may turn off for 30 minute periods, except during filter cycles.

For non-24 hour circulation systems, the circ pump and ozone generator (if installed) run during filtration (and may also run automatically at other times).

At the beginning of each filter cycle all other equipment will run briefly to purge the plumbing.

Optional Filter Cycle Programming

You are not required to change the filter cycles, but if you wish to, press “Time,” “Mode/Prog,” “Mode/Prog” within 3 seconds. **SET START FILTER 1** (AM) will appear. Press “Warm” or “Cool” to reset the filter start time.

Press “Mode/Prog” to see **SET STOP FILTER 1** and adjust the time with “Warm” or “Cool” as done above. Press “Mode/Prog” to see **SET START FILTER 2** (PM) and proceed as above. Press “Mode/Prog” to see **SET STOP FILTER 2** and proceed as above. Press “Mode/Prog” to confirm.

BALBOA
water group

Automatic polling (in Standard Mode only)

The pump will activate for 1 to 2 minutes to check the temperature:

- every 30 minutes
- whenever any other pump or blower is turned on
- whenever the set temperature is raised

Locking the Panel

Press “Time,” “Blower,” and “Warm” within 3 seconds. The Panel is now locked. To unlock the panel, press the “Time,” “Blower,” and “Cool” within 2 seconds.

Locking the Temperature

Press “Warm,” “Time,” “Blower,” and “Warm” within 3 seconds. The “Warm” and “Cool” buttons are now disabled.

To unlock the temperature, press “Time,” “Blower,” and “Cool” within 2 seconds.

Note: On some systems, “Jets 1,” instead of “Blower,” is used in Lock/Unlock sequences.

Diagnostic Messages

Message	Meaning	Action Required
--	No message on display. Power has been cut off to the spa.	The control panel will be disabled until power returns. Spa settings will be preserved until next power up.
OHH	“Overheat” - The spa has shut down.* One of the sensors has detected 118°F/47.8°C at the heater.	DO NOT ENTER THE WATER. Remove the spa cover and allow water to cool. Once the heater has cooled, reset by pushing any button. If spa does not reset, shut off the power to the spa and call your dealer or service organization.
OHS	“Overheat” - The spa has shut down.* One of the sensors has detected that the spa water is 110°F/43.5°C.	DO NOT ENTER THE WATER. Remove the spa cover and allow water to cool. At 107°F/41.7°C, the spa should automatically reset. If spa does not reset, shut off the power to the spa and call your dealer or service organization.
SnA	Spa is shut down.* The sensor that is plugged into the Sensor “A” jack is not working.	If the problem persists, contact your dealer or service organization. (May appear temporarily in an overheat condition).
SnB	Spa is shut down.* The sensor that is plugged into the Sensor “B” jack is not working.	If the problem persists, contact your dealer or service organization. (May appear temporarily in an overheat condition).
SnS	Sensors are out of balance. If alternating with spa temperature, it may just be a temporary condition. If flashing by itself, spa is shut down.*	If the problem persists, contact your dealer or service organization.
HFL	A significant difference between temperature sensors has been detected. This could indicate a flow problem.	If the water level is normal, make sure all pumps have been primed. If problem persists, contact your dealer or service organization.
LF	Persistent low flow problems. (Displays on the fifth occurrence of HFL message within 24 hours.) Heater is shut down, but other spa functions continue to run normally.	Follow action required for HFL message. Heating capability of the spa will not reset automatically; you may press any button to reset.
dr	Possible inadequate water, poor flow, or air bubbles in detected in the heater. Spa is shut down for 15 minutes.	If water level is normal, make sure all pumps have been primed. Press any button to reset. This message will reset within 15 minutes. If problem persists, contact your dealer or service organization.
dry	Inadequate water detected in heater. (Displays on third occurrence of dr message.) Spa is shut down.*	Follow action required for dr message. Spa will not automatically reset. Press any button to reset manually.
ICE	“Ice” - Potential freeze condition detected. * - Even when spa is shut down, some equipment will turn on if freeze protection is needed.	No action required. All equipment will automatically activate regardless of spa status. The equipment stays on 4 minutes after the sensors detect that the spa temperature has risen to 45°F/7.2°C or higher. An optional freeze sensor may be added to protect against extraordinary freeze conditions. Auxiliary freeze sensor protection is advisable in colder climates. See your dealer for details.

Warning! Shock Hazard! No User Serviceable Parts.

Do not attempt service of this control system. Contact your dealer or service organization for assistance. Follow all owner’s manual power connection instructions. Installation must be performed by a licensed electrician and all grounding connections must be properly installed.

P/N 40788_G 09/27/2011



TROUBLESHOOTING

UNLESS YOU HAVE THE APPROPRIATE ELECTRICAL LICENCE DO NOT OPEN THE SPAS COMPUTER BOX, PLEASE CONTACT THE STORE OF PURCHASE FOR DETAILS OF A LICENCED CONTRACTOR.

If you have any issue with your spa and the troubleshooting does not resolve your issue, please contact the store of purchase before engaging a technician or electrician for help. We will arrange a time for one of our technicians to be available to assist your technician or electrician with phone advice. Failure to do so may lead to your technician or electrician not being able to find or fix the fault leading to further unnecessary call outs to your site.