LOW VOLTAGE AC DRIVES

ABB drives for HVAC

ACH580 0.75 to 500 kW



ACH580 series

Leading the way in HVAC drives

Comfort. It's something we take for granted in the buildings we live and work in. But comfort requires efficient systems controlling heating, ventilation, and air conditioning and cooling (HVAC/R) to ensure the air we breathe is pure and the temperature is comfortable. We also need to ensure air quality in the most energy-efficient and cost-effective way – as well as safety – in both normal and mission-critical situations.

For half a century, ABB has been leading the way in optimizing HVAC systems using drive control to ensure that you can take comfort for granted. The new ACH580 series of variable frequency drives (VFDs) provide the quality, reliability, and energy savings you expect, and are easy to use and safe to maintain. All you need to do is to set the drive up, and then focus on what counts.

Contents

004	The next step in HVAC drives
006	Premier air handling
008	Precise water flow control
010	What does all-compatible mean for you?
012	Complete offering, from wall-mounted and cabinet-built drives, to ultra-low harmonic drive variants
014	Overcome challenges of harmonics
016	How to select a drive
017	Technical data
018	Dimensions
020	Ratings, types and voltages
022	Comprehensive connectivity
023	Options
024	Save time, ease troubleshooting and improve drive performance with ABB smartphone apps
025	High protection for operation in harsh environments
025	Flange mounting
025	Advanced cooling
026	du/dt filters
028	Selection guide - IE4 synchronous reluctance motors
030	Ultimate efficiency and reliability to optimize your system's total cost of ownership
031	Choose the motor for you HVAC application
032	Services to match your needs
033	Drives service - Your choice, your future
034	A lifetime of peak performance

The next step in HVAC drives

The new ACH580 drives come with a range of advanced features, such as a new primary settings menu that makes commissioning the drives much easier and faster. Bluetooth connectivity improves the accessibility of drives installed in remote areas and increases safety by giving users the ability to stay out of arc flash zones.

Simple to select, install and use

All the essentials – such as chokes, EMC filters, enclosures from IP21/UL Type 1 to IP55/UL Type 12, cabling clamps, and certified BACnet communication – are built into the drive, simplifying selection, installation, and commissioning.

Safe maintenance

The new packaged disconnect solution provides a mains disconnect switch, which further increases safety for people working on the air-handling unit.

Motor control options to meet your application needs

ACH580 drives can be integrated with virtually any type of AC motor, even high-efficiency PM motors and SynRM. The ability to use these motors can reduce your energy costs even more.



Additional I/O options

Never be without back-up I/O points on the jobsite again taking advantage of the added flexibility and accessibility.



ACH580 drives are ideal for the HVAC fans, pumps, compressors, air-handling units and chillers used in hospitals, data centers, shopping centers, tunnel ventilation, factories, office buildings, and more.



Intuitive Bluetooth® control panel

ABB's new HVAC Bluetooth control panel lets you commission the drive remotely, safely outside the arc flash boundary. You can customize the view so that it only shows the information you need, and it automatically saves a backup of your most recent configuration so that it's always available.



Reliable communication

Modbus RTU and BACnet MS/TP are embedded in every ACH580. In addition, a wide range of optional fieldbus adapters are available to enable connectivity with all major building automation and control systems.

Ultra-low harmonic (ULH) for a clean network

The revolutionary ACH580 ultra-low harmonic drive is designed specifically for the HVAC market, minimizing the effect of harmonics on your system. This all-in-one solution is fully integrated with the ACH580 platform and leverages the same programming tools, user settings, options, and functions, and providing excellent harmonic performance.

Premier air handling

We understand the complexity of air handling systems and the need to produce high levels of comfort, control, and safety. Be assured that, regardless of the season or external conditions, we help to make your system efficient, safe, and informative.

Effortless system startup

The ACH580 ensures a smooth, coordinated start to your HVAC system. Embedded interlock logic enables the drive to confirm that equipment position, such as dampers, and sensor status are correct before operations begin.

Increased energy savings

Achieve increased energy savings by using the appropriate motor and drive combination. The ACH580 drive works with induction motors, PM motors, or SynRMs, which enable high efficiencies.

Improved safety

Built-in safety functionality, such as override mode, enables your system to ignore all non-essential faults during emergencies to maintain air quality in the fire exit paths.

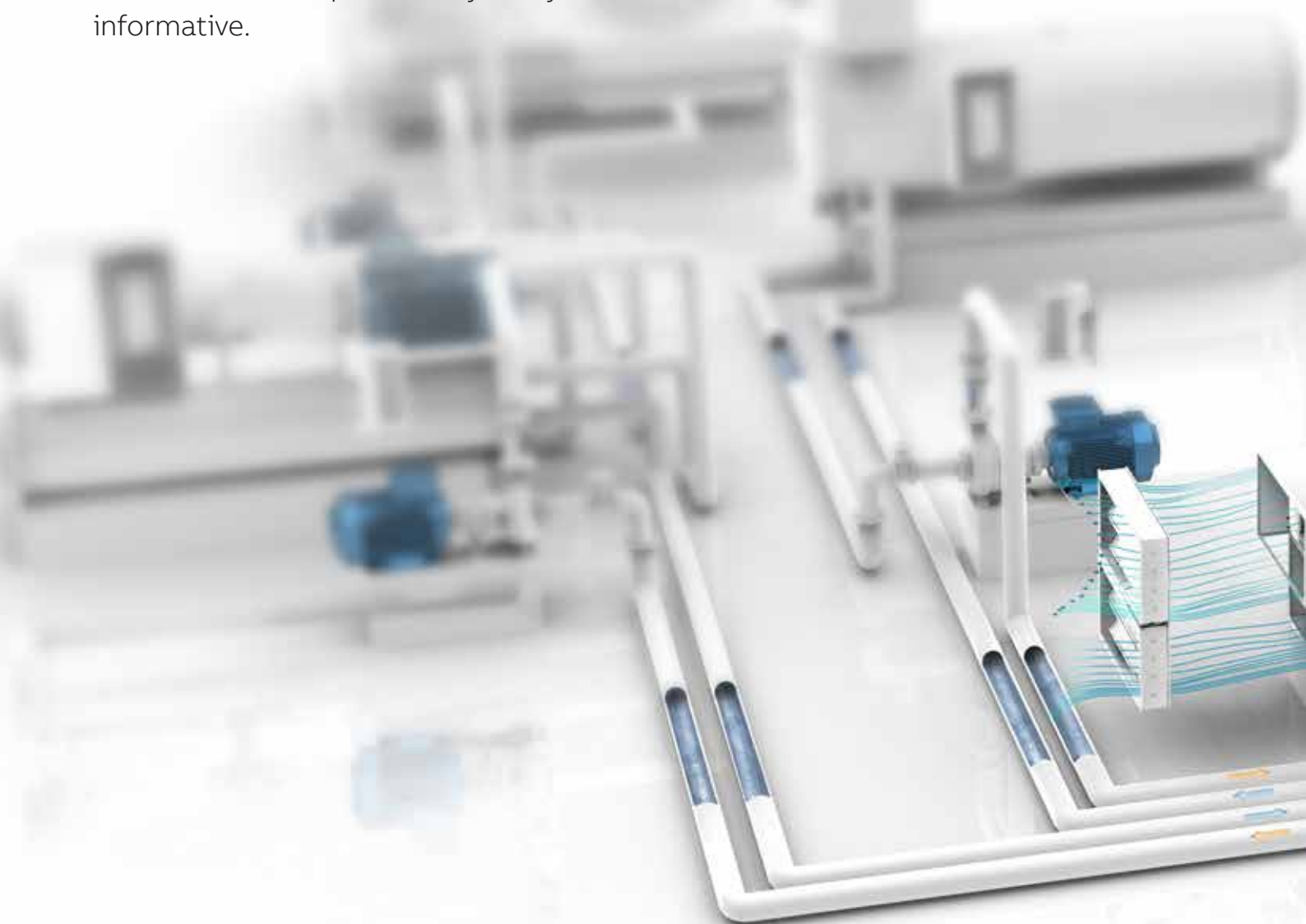

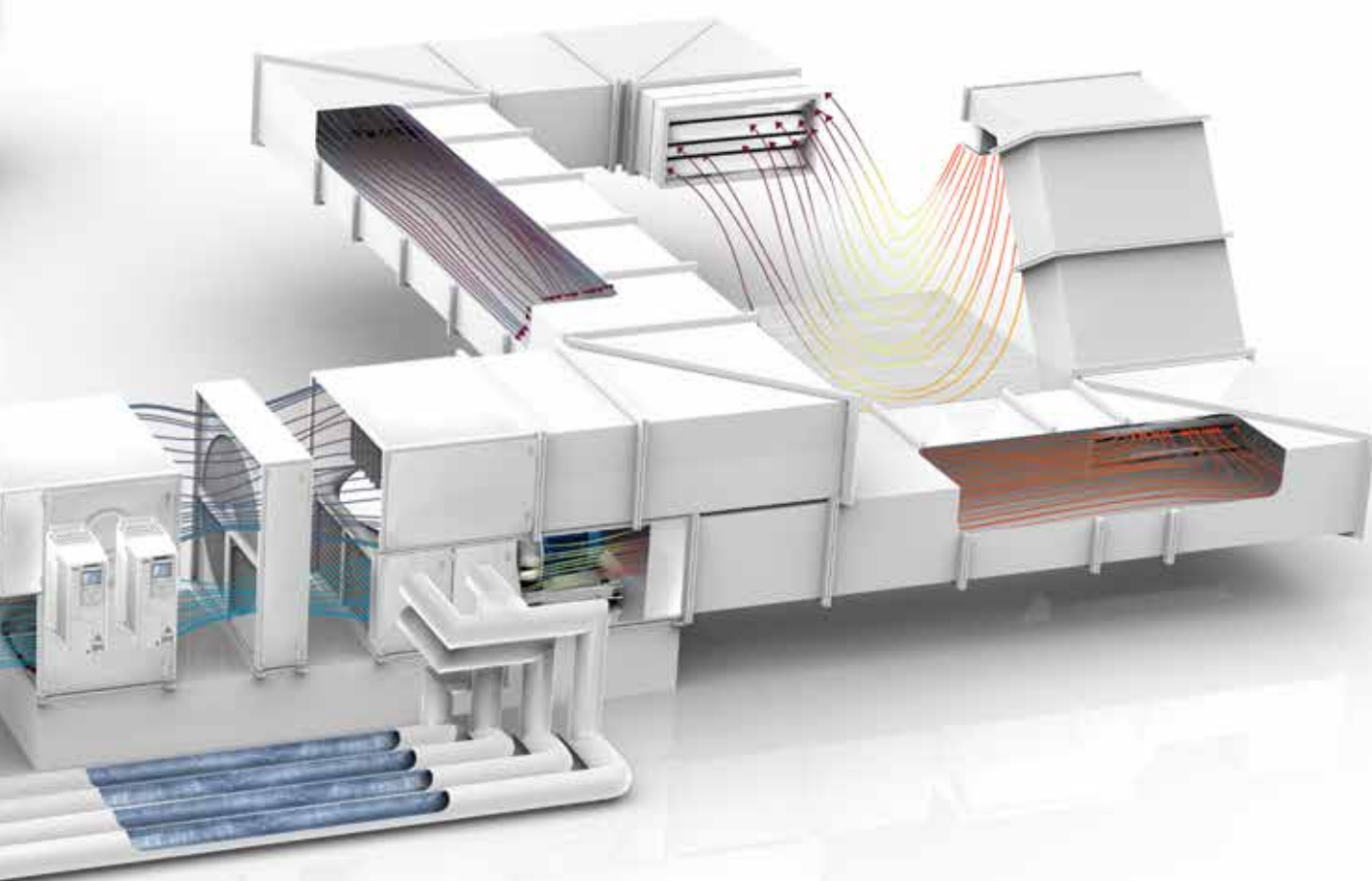
**Reduced costs**

The ACH580 reduces costs, for example, by eliminating dependencies on external controllers. The drive can use its internal PID loops to reach a pressure setpoint by checking the active pressure and adjusting the fan speed accordingly.

Optimal system efficiency

Leverage advanced system monitoring, which controls fans and pumps based on feedback from the drive. Use this information to plan maintenance based on the actual needs of the application. For example, with built-in monitoring, the drive notifies you when it's time to take action when a fan stalls, a belt breaks, a filter clogs, and more.

Precise water flow control

The control of water flows in HVAC systems allows you to regulate temperatures in a building. Pumps, chillers, and cooling towers all need to be coordinated. Your system benefits from motor control that operates as efficiently and simply as possible, with functions designed to keep the flow rate in accordance with current needs.

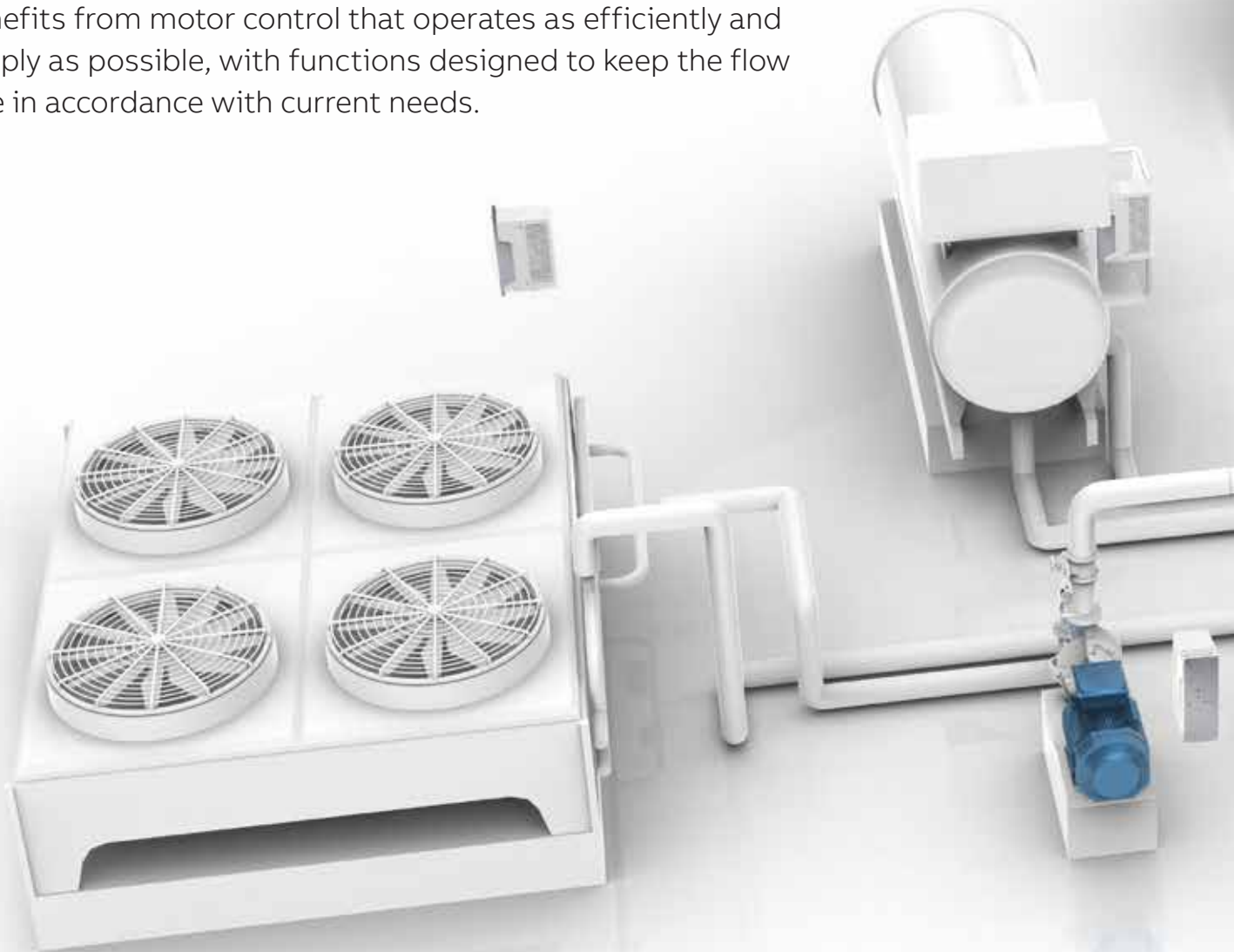

Motor monitoring prevents problems

Protect your investment with onboard monitoring. Monitor and show trends of key attributes for preventative maintenance.

Protect your equipment

Extend equipment life (e. g., pipes, motors, check valves, and pumps) with intelligent motor control. By starting the pumping system smoothly, you protect the system from running without water in the pump, and can manage the flow and the pressure accurately.

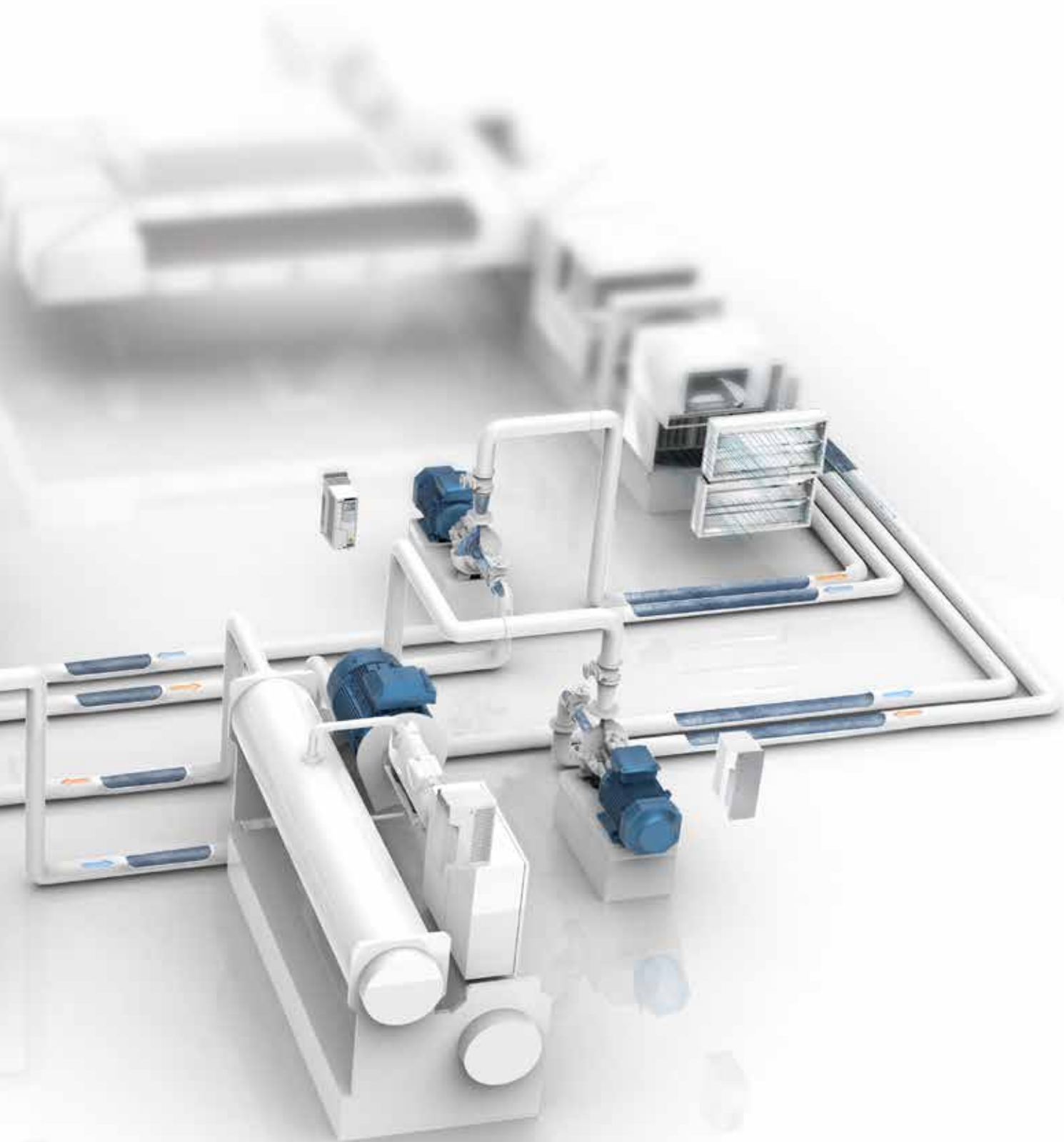

Energy savings through intelligent control

Intelligent motor control replaces throttle or bypass valves, enabling better control of flow, resulting in energy savings. In addition, fewer mechanical parts results in minimizing wear and tear on the system. To gain additional savings, pair drives with premium-efficiency motors and enable energy optimizer functions to reduce operating costs over the lifetime of the pumping system.

System optimization

As demand fluctuates during the day, the system automatically adjusts to the current demand. The ACH580 provides optimal pressure when needed, and goes into sleep mode when it's not. For example, for systems requiring booster pumps, demand typically varies throughout the day and falls drastically at night and again in the morning.

What does all-compatible mean for you?

Business all-compatible

The all-compatible drives are not just equipment – they are part of your facility management strategy. Providing better control over your processes, our drives mean lower energy consumption, improved indoor air quality, flexibility, and ease of use. In addition to drives, we offer a wide range of products and services to support your business. With offices in over 90 countries and a global network of technical partners, we are in a good position to offer technical advice and local support, worldwide.

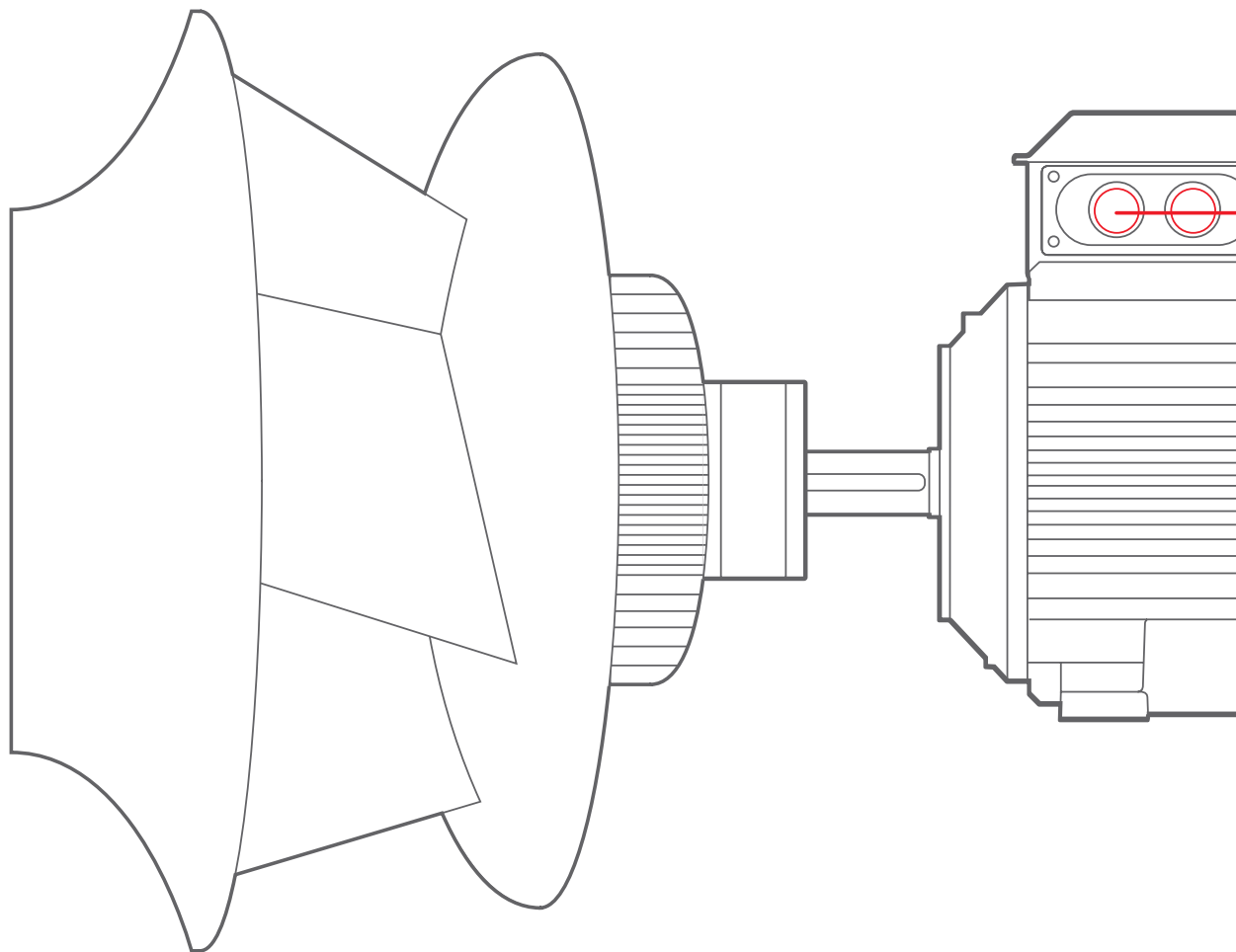

Process all-compatible

The drives are compatible with all kinds of processes. They control virtually any type of AC motor, provide extensive input/output connectivity, and support all major fieldbus protocols. The drives cover a wide voltage and power range. The flexibility and scalability of the drives enable one drive platform to control virtually any HVAC application or process, making your drive selection easy.

Environment all-compatible

There is increased demand for industries to reduce their impact on the environment. Our drives can help you reduce energy consumption in a wide range of applications. Our drives have an energy optimizer feature, reducing energy drawn from the supply. The built-in energy efficiency calculators help you to analyze and optimize your processes. We make it easy for you to see the energy savings of selected applications with our six-step energy appraisal.

Our wall-mounted ACH580 HVAC drives comply with the requirements of the highest IE2 drive (EN 50598-2) energy efficiency class, further reducing environmental impact. In addition, all ACH580 HVAC drives are compatible with high-efficiency IE4 and IE5 motors.

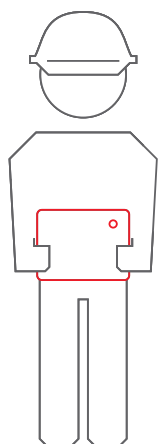
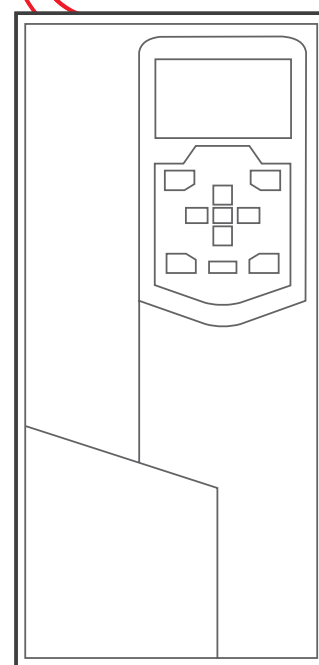
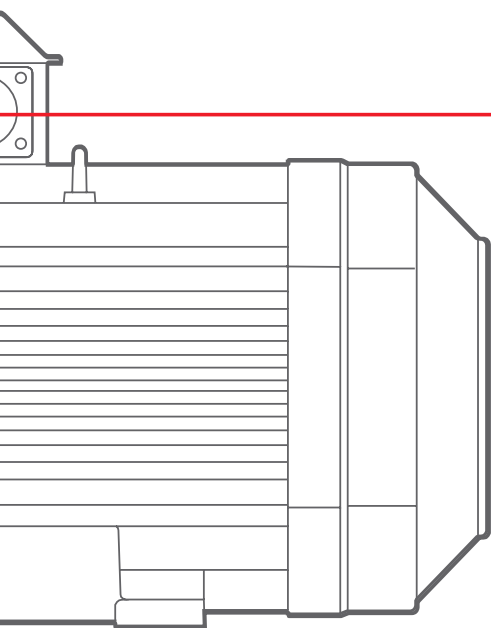
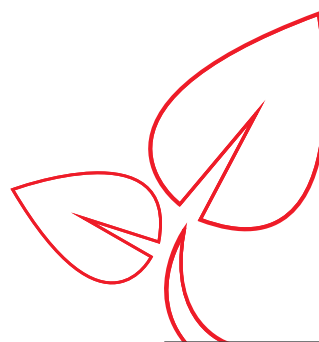

Human all-compatible

All our drives share easy-to-use interfaces, saving you time during drive commissioning and maintenance. When you have learned it once, you can use it with all the drives in our all-compatible drives portfolio.

The control panel supports a large number of languages. With the PC tool, you get extensive drive monitoring capabilities and quick access to the drive settings. Integrated and certified safety features provide safety for machine operators.

To further improve the user experience, we have developed the primary settings menu. Also, the mobile apps can be utilized in interacting with the drive. These apps give you an easy graphical interface for management, maintenance, and service of your drives.

Complete offering, from wall-mounted and cabinet-built drives, to ultra-low harmonic drive variants

No matter the frame size or power, all ACH580 drives offer ease of use, scalability, and quality.

—
01 Wall-mounted
ACH580 drive

—
02 ACH580 drive
module with IP00

—
03 Cabinet-built
ACH580 drive

—
04 Ultra-low harmonics
ACH580 drive

Wall-mounted drives

The ACH580 wall-mounted drives are available with IP21 or IP55 protection class. The wall-mounted IP21 drives are available in a power and voltage range of 0.75–250 kW and 3-phase, 380–480 V, and offer side-by-side, flange, and horizontal mounting options.

The IP55 variants are designed for applications exposed to dust, moisture, vibration, and other harsh conditions. Similar in size to the compact IP21 drives, they offer significant savings on space, maintenance and engineering, costs, and setup and commissioning time. Typical industries include food and beverages, printing, and rubber and plastics.

Drive modules for cabinet installation

ACH580 drive modules are perfect for system integrators, cabinet builders, and OEMs who want to optimize cabinet design in the 250–500 kW range without compromising on easy installation, commissioning and maintenance.

Cabinet-built drives

Cabinet-built ACH580 drives are available with IP21 protection class as standard (with optional IP42 and IP54 enclosures) in frame sizes R6 to R11. The drives feature a new cooling arrangement and a high-quality, global cabinet design. Available in a power and voltage range of 75–500 kW and 3-phase, 380–480 V.

Ultra-low harmonic drives

The ACH580 ultra-low harmonic drives help to keep the power network clean. With harmonics mitigation built into the drive, the ultra-low harmonic drive produces exceptionally low harmonic content and provides significant benefits, including improved reliability and increased energy savings, as well as extended equipment lifetime.



The ACH580 drives series provides common features throughout the whole product family, making it easy for you to install, commission, and use them for your entire installation.

Overcome challenges of harmonics

ACH580 ultra-low harmonic drives have excellent harmonics performance and are perfectly suited for places that cannot handle high harmonic content in the network.

The problem with harmonics

Generators in power plants rotate at constant and regulated speed, resulting in a sine-wave-shaped current in an AC grid in the ideal case.

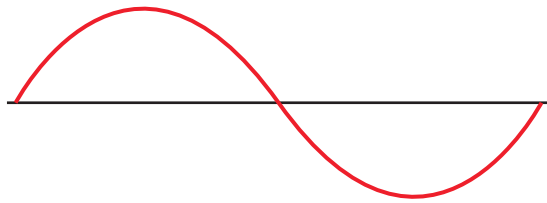

However, in reality, it is often is not the case, as electricity networks are affected by harmonics: higher-order oscillations introduced by various types of electrical equipment.

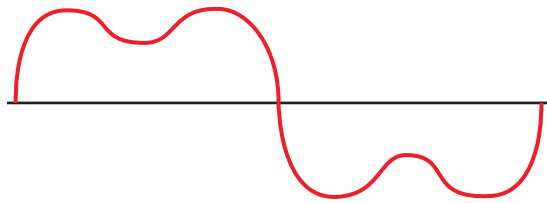

Harmonics in electrical systems can have negative effects, such as overheating or malfunctioning of equipment connected to the grid. With 40% THDi level the need for over dimensioning is approximately 35%.

All-in-one concept for a clean network

ABBs HVAC ultra-low harmonic (ULH) drives are designed with built-in harmonic avoidance systems and meet low harmonic limit recommendations by IEEE519 and G5/5. By equipping the drives with specific features and capabilities, the problems caused by harmonics are avoided in the first place.

There is no need to install external harmonic filters or multi-pulse transformers, leading to significant savings in the footprint. Compared to other harmonic reduction solutions, the ULH drive has excellent harmonic performance ensuring that the current harmonics in undistorted networks are always less than 3%.

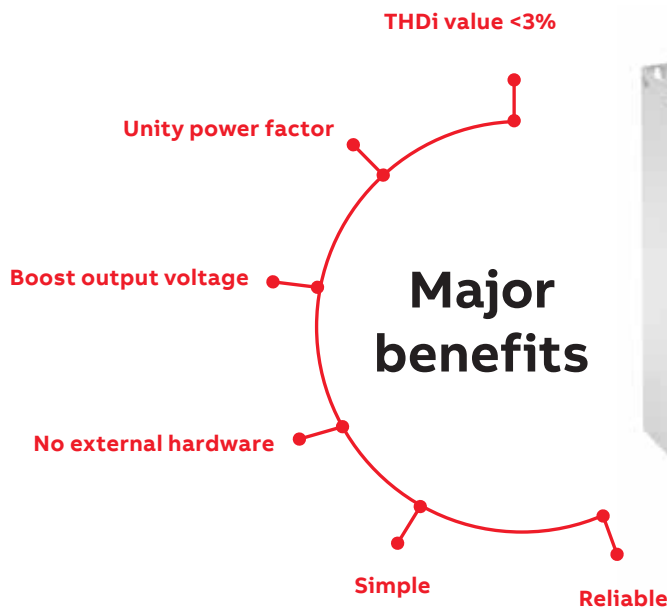

ULH drive technology

With an integrated design that leverages drive technology as part of the harmonic solution, there is no risk of nuisance trips due to incompatible components, no need for additional hardware, and no additional cooling requirements.

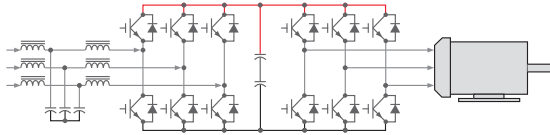

Lower energy consumption at system level

The HVAC ULH drive reaches unity power factor, indicating that electrical energy is being used efficiently. Active power factor compensation allows the ULH drive to improve the power factor of the building grid, while maintaining the unity power factor on the connected equipment.

Reliable operation under special conditions

The ULH drive ensures that the motor receives the full voltage, even in low-voltage utility conditions. Thanks to the drives' capability to provide an output voltage at a level greater than the supply voltage, applications can overcome voltage drops caused by long supply or long motor cables. All this is done without costly additional equipment or oversizing of drive system components.

Other ways of mitigating harmonics

Passive filter equipment must always be sized for the maximum current, but be aware that the duration of partial-load operation is very significant. Oversizing gives poor mitigation performance and high running costs when running at partial load. It is also a waste of money, as the harmonics are not mitigated properly under partial-load conditions.

With multipulse transformers, you always need to install additional transformers, and the mitigation level isn't at the same low level as in a ULH drive.

Of course, the need for the mitigation is different, and there is no one-size-fits-all solution.

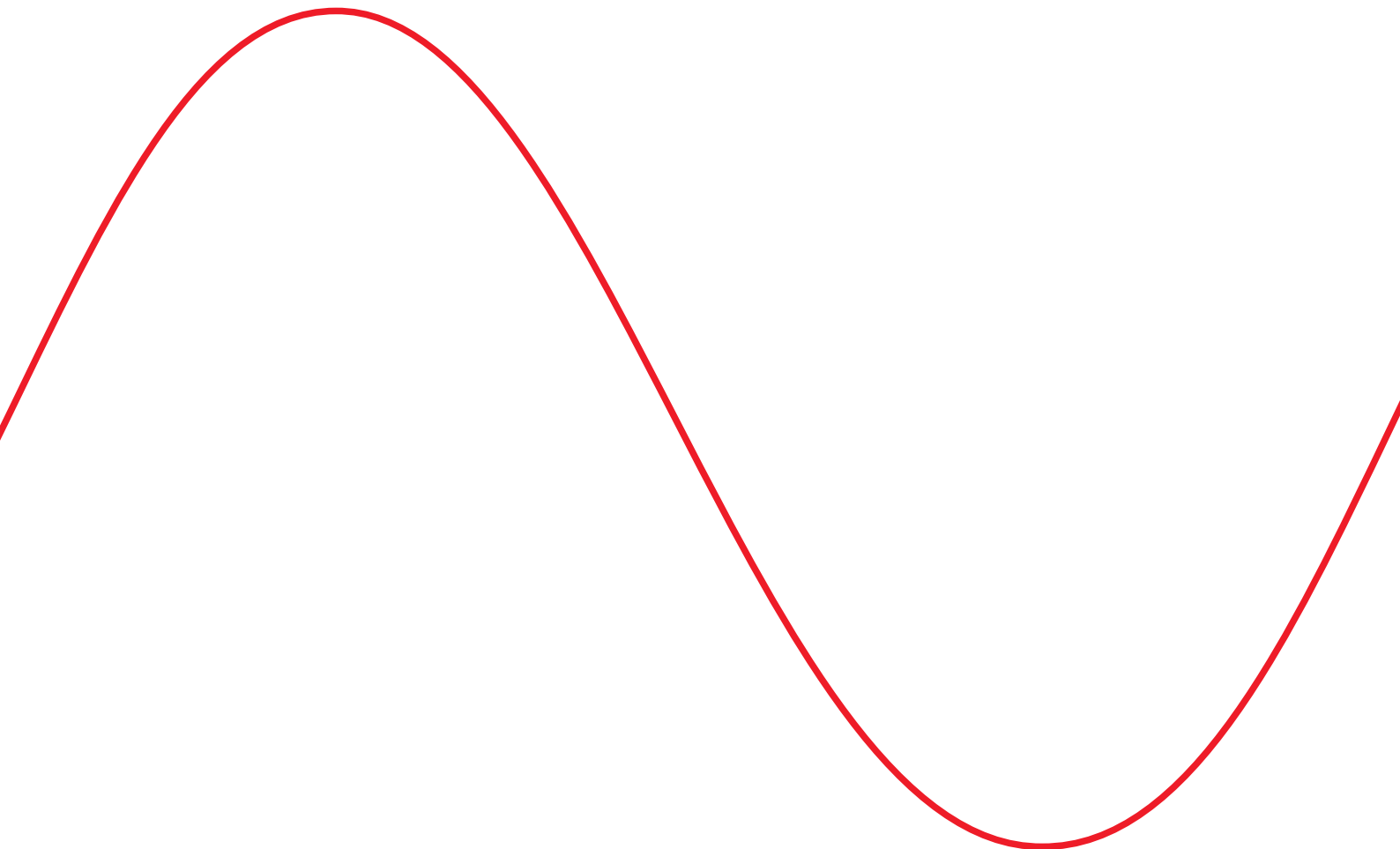

How to select a drive

This is how you build up your own ordering code using the type designation key.

1 Start by identifying your supply voltage.

This tells you what rating table to use. See pages 20 and 21.



2 Choose your motor's power and current rating from the ratings tables on pages 20 and 21.

3 Select your drive's order code from the rating table based on your motor's nominal power rating.



Pages 20 and 21

Pages 20 and 21

4 Choose your options (on page 23) and add the option codes to the drive's order code. Remember to use a "+" mark before each option code.



Page 23

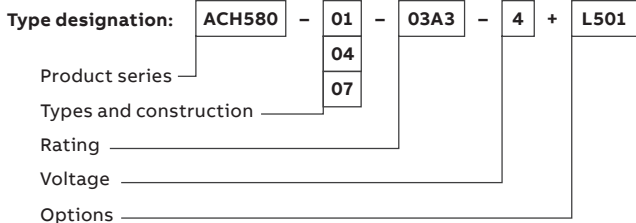

Technical data

Supply connection		External power supply	
Voltage and power range	3-phase U_N 380 to 480 V, +10/-15% ACH580-01: from 0.75 up to 250 kW ACH580-04: from 250 up to 500 kW ACH580-07: from 75 up to 500 kW ACH580-31: from 4 to 45 kW auto-identification of supply voltage	Standard: ACH580-01 frames R6-R9 ACH580-04 all frames ACH580-07 all frames ACH580-31 all frames Optional: ACH580-01 frames R1-R5	1.5 A at 24 V AC/DC ±10% 1.5 A at 24 V AC/DC ±10% 1.5 A at 24 V AC/DC ±10% 1.5 A at 24 V AC/DC ±10% 1.04 A at 24 V AC/DC ±10%
Frequency	48 to 63 Hz	Communication	
Fundamental power factor ACH580-01, ACH580-04 and ACH580-07	0.98	Protocols as standard (EIA-485): BACnet MS/TP, Modbus RTU Available as plug-in options: BACnet/IP, Modbus TCP, PROFIBUS-DP, PROFINET, CANopen, DeviceNet, EtherNet/IP, EtherCAT, EtherNet POWERLINK Available as an external option: 2-port EtherNet adapter for remote monitoring	
Fundamental power factor ACH580-31	1.0	Application functions	
Efficiency at rated power	98%	First start assistant Primary settings for HVAC applications Hand-Off-Auto operation mode Start interlock (de-frost) Delayed start Run permissive (damper monitoring) Override operation mode Real-time clock (scheduling) PID controllers for motor and process Motor flying start Motor preheating Energy optimizer and calculators	
Motor connection		Protection functions	
Supported motor control	Scalar and vector	Overvoltage controller Undervoltage controller Motor earth-leakage monitoring Motor short-circuit protection Motor overtemperature protection Output and input switch supervision Motor overload protection Phase-loss detection (both motor and supply) Under load supervision (belt loss detection) Overload supervision Stall protection Loss of AI signal monitoring	
Supported motor types	Asynchronous motor, permanent magnet motor (vector), SynRM (vector)	Product compliance	
Voltage	3-phase, from 0 to supply voltage	Standards and directives	
Frequency	0 to 500 Hz	Low Voltage Directive 2006/95/EC EMC Directive 2004/108/EC Quality assurance system ISO 9001 and Environmental system ISO 14001 CE, UL, cUL, and EAC approvals Galvanic isolation according to PELV RoHS2 (Restriction of Hazardous Substances) EN 61800-5-1: 2007; IEC/EN 61000-3-12; EN61800-3: 2017 + A1: 2012 Category C2 (1 st environment restricted distribution); Safe torque off (EN 61800-5-2)	
Environmental limits		EMC (according to EN61800-3)	
Ambient temperature		Harmonics	
Transportation and storage	-40 to 70 °C	IEC/EN 61000-3-12 With ACH580-31 also IEE519 G5/5	
Air temperature/relative humidity (operation)	ACH580-01, ACH580-31: -15 to +50 °C; ACH580-07: 0 to +50 °C ACH580-04: -15 to +55 °C. 5 to 95% no condensation allowed		
Output current	Rated current available at 0 to 1000 m reduced by 1% per 100 m over 1000 m up to 4000 m		
Degree of protection	ACH580-01 and ACH580-31: IP21 (UL type 1) or IP55 (UL type 12) ACH580-04: IP00, IP20 ACH580-07: IP21 as standard, IP42 or IP54 as option		
Inputs and outputs			
2 analog inputs	Selection of Current/Voltage input mode is user programmable.		
Voltage signal	0 (2) to 10 V, $R_{in} > 200 \text{ k}\Omega$		
Current signal	0 (4) to 20 mA, $R_{in} = 100 \text{ }\Omega$		
Potentiometer reference value	10 V ±1% max. 20 mA		
2 analog outputs	AO1 is user programmable for current or voltage. AO2 current		
Voltage signal	0 to 10 V, $R_{load} > 100 \text{ k}\Omega$		
Current signal	0 to 20 mA, $R_{load} < 500 \text{ }\Omega$		
Internal auxiliary voltage	24 V DC ±10%, max. 250 mA		
6 digital inputs	12 to 24 V DC, 24 V AC. Connectivity of PTC sen- sors supported by a single digital input. PNP or NPN connection (5 DIs with NPN connection).		
3 relay outputs	Maximum switching voltage 250 V AC/30 V DC. Maximum continuous current 2 A rms.		
PTC, PT100 and PT1000	Any of the analog inputs, or digital input 6, are configurable for PTC with up to 6 sensors. Both analog outputs can be used to feed the PT100 and PT1000 sensor and KTY83, KTY84 or Ni1000 sensors.		

Dimensions

ACH580-01

ACH580-01, wall-mounted frames IP21

Frames IP21	Height		Width		Depth		Weight		
	H1* (mm)	H2** (mm)	in	mm	in	mm	in	kg	lb
R1	303	303	11.9	125	4.9	210	8.3	4.5	9.9
R1	303	303	11.9	125	4.9	223	8.8	4.6	10
R2	394	394	15.5	125	4.9	227	8.9	7.5	16.6
R3	454	454	17.9	203	8	228	9	14.9	32.8
R4	600	600	23.6	203	8	258	10.16	19.0	43
R5	732	596	28.3	203	8	295	11.6	28.5	62.4
R6	727	549	28.6	252	9.9	369	14.5	45	99.2
R7	880	601	34.6	284	11.2	370	14.6	54	119.1
R8	965	677	38	300	11.8	393	15.5	69	152.2
R9	955	680	37.6	380	15	418	16.5	97	213.9

* Front height of the drive with glandbox

** Front height of the drive without glandbox



ACH580-01, wall-mounted frames IP55

Frames IP55	Height		Width		Depth		Weight		
	H1* (mm)	H2** (mm)	in	mm	in	mm	in	kg	lb
R1	303	303	11.9	125	4.9	222	8.74	5.1	11.16
R1	303	303	11.9	125	4.9	233	9.17	5.5	12.08
R2	394	394	15.5	125	4.9	239	9.41	7.8	17.22
R3	454	454	17.9	203	8	237	9.33	15.1	333.32
R4	600	600	23.6	203	8	265	10.16	20	44.10
R5	732	596	28.3	203	8	320	12.6	29	64
R6	727	549	28.6	252	9.9	380	14.96	46	101.43
R7	880	601	34.6	284	11.2	381	15	56	123.48
R8	965	677	38	300	11.8	452	17.8	77	169.8
R9	955	680	37.6	380	15	477	18.78	103	227.1

* Front height of the drive with glandbox

** Front height of the drive without glandbox

ACH580-04

ACH580-04

Frames IP00/ IP20	Height		Width		Depth		Weight	
	mm	in	mm	in	mm	in	kg	lb
R10	1461.8	57.6	350	13.8	528.6	20.8	162	357.5
R11	1661.8	65.4	350	13.8	528.6	20.8	200	440.9



ACH580-07

ACH580-07

Frames IP21	Height		Width		Depth		Weight	
	mm	in	mm	in	mm	in	kg	lb
R6	2145	84.43	430	16.93	673	26.50	210	463
R7	2145	84.43	430	16.93	673	26.50	220	485
R8	2145	84.43	530	20.87	673	26.50	255	562
R9	2145	84.43	530	20.87	673	26.50	275	606
R10	2145	84.43	830	32.68	698	27.48	535	1179
R11	2145	84.43	830	32.68	698	27.48	581	1280



ACH580-31

ACH580-31 IP21

Frames IP21	Height				Width		Depth		Weight	
	H1	H2	H1	H2	mm	in	mm	in	kg	lb
	(mm)	(mm)	(in)	(in)						
R3	490	490	19.29	19.29	205	8.07	354	13.93	21.3	46.96
R6	771	771	30.35	30.35	252	9.92	381.7	15.03	61	134.48

ACH580-31 IP55

Frames IP55	Height				Width		Depth		Weight	
	H1	H2	H1	H2	mm	in	mm	in	kg	lb
	(mm)	(mm)	(in)	(in)						
R3	490	490	19.29	19.29	205	8.07	360	14.17	21.3/23	50.71
R6	771	771	30.35	30.35	252	9.92	448.9	17.67	61/63	138.89

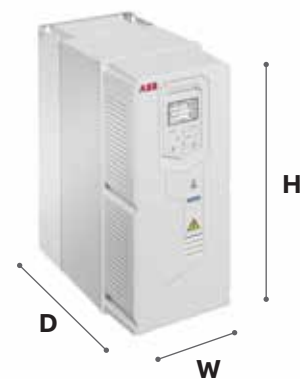

Ratings, types and voltages

ACH580-01

3-phase, $U_N = 380...415$ V (380, 400, 415 V). The power ratings are valid at nominal voltage 400 V (0.75 to 250 kW).

Nominal ratings		Maximum output current		Light-overload use		Type designation	Frame size
P_N kW	I_N A	I_{max} A	P_{Ld} kW	I_{Ld} A			
0.75	2.6	3.2	0.75	2.5	ACH580-01-02A7-4	R1	
1.1	3.3	4.7	1.1	3.1	ACH580-01-03A4-4	R1	
1.5	4	5.9	1.5	3.8	ACH580-01-04A1-4	R1	
2.2	5.6	7.2	2.2	5.3	ACH580-01-05A7-4	R1	
3	7.2	10.1	3	6.8	ACH580-01-07A3-4	R1	
4	9.4	13	4	8.9	ACH580-01-09A5-4	R1	
5.5	12.6	14.1	5.5	12	ACH580-01-12A7-4	R1	
7.5	17	22.7	7.5	16.2	ACH580-01-018A-4	R2	
11	25	30.6	11	23.8	ACH580-01-026A-4	R2	
15	32	44.3	15	30.4	ACH580-01-033A-4	R3	
18.5	38	56.9	18.5	36.1	ACH580-01-039A-4	R3	
22	45	67.9	22	42.8	ACH580-01-046A-4	R3	
30	62	76	30	58	ACH580-01-062A-4	R4	
37	73	104	37	68.4	ACH580-01-073A-4	R4	
45	88	122	45	82.7	ACH580-01-088A-4	R5	
55	106	148	55	100	ACH580-01-106A-4	R5	
75	145	178	75	138	ACH580-01-145A-4	R6	
90	169	247	90	161	ACH580-01-169A-4	R7	
110	206	287	110	196	ACH580-01-206A-4	R7	
132	246	350	132	234	ACH580-01-246A-4	R8	
160	293	418	160	278	ACH580-01-293A-4	R8	
200	363	498	200	345	ACH580-01-363A-4	R9	
250	430	617	200	400	ACH580-01-430A-4	R9	

ACH580-04

3-phase, $U_N = 380...480$ V (400 V). The power ratings are valid at nominal voltage 400 V (250 to 500 kW).

Nominal ratings		Maximum output current		Light-overload use		Type designation	Frame size
P_N kW	I_N A	I_{max} A	P_{Ld} kW	I_{Ld} A			
250	505	560	250	485	ACH580-04-505A-4	R10	
315	585	730	315	575	ACH580-04-585A-4	R10	
355	650	730	355	634	ACH580-04-650A-4	R10	
400	725	1020	400	715	ACH580-04-725A-4	R11	
450	820	1020	450	810	ACH580-04-820A-4	R11	
500	880	1100	500	865	ACH580-04-880A-4	R11	

ACH580-07

3-phase, $U_N = 380...480$ V (400 V). The power ratings are valid at nominal voltage 400 V (75 to 500 kW).

Nominal ratings		Maximum output current		Light-overload use		Type designation	Frame size
P_N kW	I_N A	I_{max} A	P_{Ld} kW	I_{Ld} A			
75	145	178	75	138	ACH580-07-145A-4	R6	
90	169	247	90	161	ACH580-07-169A-4	R7	
110	206	287	110	196	ACH580-07-206A-4	R7	
132	246	350	132	234	ACH580-07-246A-4	R8	
160	293	418	160	278	ACH580-07-293A-4	R8	
200	363	498	200	345	ACH580-07-363A-4	R9	
250	430	617	200	400	ACH580-07-430A-4	R9	
250	505	560	250	485	ACH580-07-505A-4	R10	
315	585	730	315	575	ACH580-07-585A-4	R10	
355	650	730	355	634	ACH580-07-650A-4	R10	
400	725	1020	400	715	ACH580-07-725A-4	R11	
450	820	1020	450	810	ACH580-07-820A-4	R11	
500	880	1100	500	865	ACH580-07-880A-4	R11	

ACH580-31

3-phase, $U_N = 380...415$ V (380, 400, 415 V). The power ratings are valid at nominal voltage 400 V (4 to 45 kW).

Nominal ratings		Maximum output current		Light-overload use		Type designation	Frame size
P_N kW	I_N A	I_{max} A	P_{Ld} kW	I_{Ld} A			
4	7	12.2	4	8.9	ACH580-31-09A5-4	R3	
5.5	9.4	16	5.5	12	ACH580-31-12A7-4	R3	
7.5	12.8	21.4	7.5	16.2	ACH580-31-018A-4	R3	
11	18.7	28.8	11	23.8	ACH580-31-026A-4	R3	
15	26	42.5	15	30.4	ACH580-31-033A-4	R6	
18.5	32	54.4	18.5	36.1	ACH580-31-039A-4	R6	
22	38	64.6	22	42.8	ACH580-31-046A-4	R6	
30	49	77.5	30	58.9	ACH580-31-062A-4	R6	
37	60	105.4	37	69.4	ACH580-31-073A-4	R6	
45	73	124.1	45	83.6	ACH580-31-088A-4	R6	

Nominal ratings

I_N Rated current available continuously without overloadability at 40 °C.

P_N Typical motor power in no-overload use.

Maximum output current

I_{max} Maximum output current. Available for 2 seconds at start, then as long as allowed by drive temperature.

Light-overload use

I_{Ld} Continuous current allowing 110% I_{Ld} for 1 minute every 10 minutes at 40 °C.

P_{Ld} Typical motor power in light-overload use.

For derating at higher altitudes, temperatures or switching frequencies, see the HW manuals, document codes:

3AUA0000076331 ACH580-01

3AXD50000048685 ACH580-04

3AXD50000105090 ACH580-07

3AXD50000037066 ACH580-31

Comprehensive connectivity

Default control connections to the CCU-23 control unit

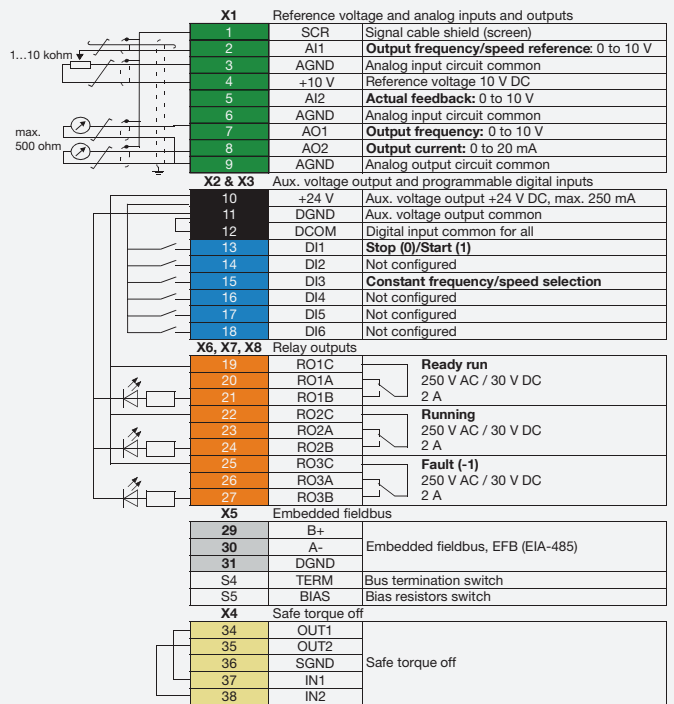
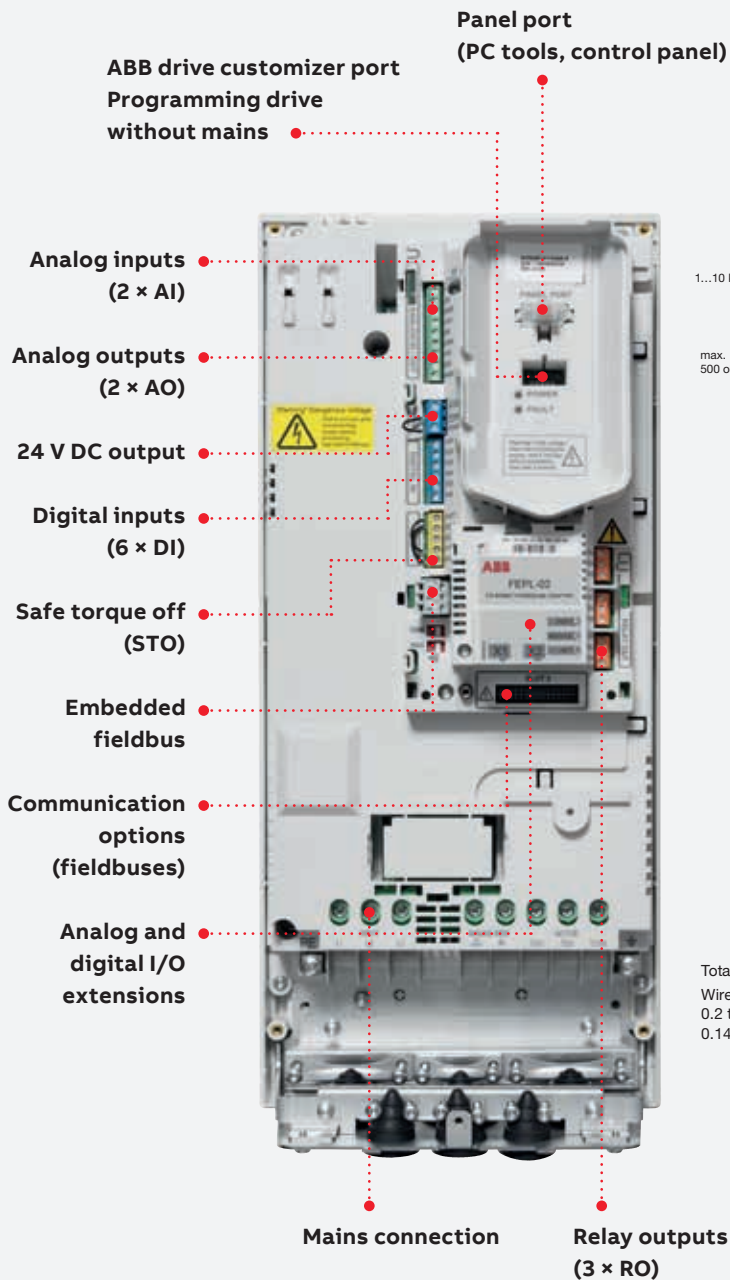

Total load capacity of the auxiliary voltage output +24 V (X2:10) is 6.0 W (250 mA/24 V DC).
 Wire sizes:
 0.2 to 2.5 mm² (24 to 14 AWG): terminals +24 V, DGND, DCOM, B+, A-, DGND, ext. 24 V
 0.14 to 1.5 mm² (26 to 16 AWG): terminals DI, AI, AO, AGND, RO, STO

Options

Controlling your drive remotely eliminates the need to be at the drive to make adjustments. Accurate remote diagnostics are possible through the building-management system (BMS), which enables real-time monitoring. Total building system costs are reduced thanks to the reduced wiring and number of building automation I/O points, and the ability to use passthrough I/O.

I/O options

Option code	Description	Type designation
+L501	External 24 V AC/DC and digital I/O extension (2xRO and 1xDO)	CMOD-01
+L523	External 24 V DC/AC and isolated PTC interface with capability to trigger STO	CMOD-02
+L512	115/230V digital input (6xDI and 2xRO)	CHDI-01

Input/output extension modules

Standard input and output can be extended by using optional analog and digital input/output extension modules.

Fieldbus adapters

Option code	Fieldbus protocol	Adapter
+K465	BACnet/IP (2-port)	FBIP-21
+K454	PROFIBUS-DP	FFBA-01
+K457	CANopen	FCAN-01
+K451	DeviceNet	FDNA-01
+K469	EtherCAT	FECA-01
+K458	Modbus RTU	F8CA-01
+K470	Ethernet POWERLINK	FEPL-02
+K462	ControlNet	FCNA-01
+K475	2-port Ethernet (EtherNet/IP™, Modbus TCP, PROFINET)	FENA-21

BACnet/IP option

Native BACnet/IP allows for greater bandwidth for more frequent polling/monitoring and more devices on the same sub-network. Thanks to the two-port design of this adapter, the need for external switches and installation time are reduced. Different buildings may have different fieldbuses, and we have multiple option modules to satisfy your needs.

Control panel options

HVAC control panel (ACH-AP-H) is included as standard in the delivery unless otherwise specified.

Option code	Description	Type designation
+J400	HVAC control panel (standard)	ACH-AP-H
+J429	Control panel with Bluetooth interface	ACH-AP-W
+J424	Blank control panel cover (no control panel delivered)	CDUM-01
3AXD5000004419	Panel bus adapter (no control panel delivered)	CDPI-01
3AUA0000108878	Control panel mounting platform (flush mounted, requires also panel bus adapter on the drive)	DPMP-01
3AXD5000009374	Control panel mounting platform (surface mounted, requires also panel bus adapter on the drive)	DPMP-02
3AXD50000016230	Control panel mounting platform option, only for ACS580-04 modules	DPMP-03
3AXD50000010763	Door mounting kit for the panel (for one drive, contains both DPMP-02 and CDPI-01)	DPMP-EXT

Wireless connectivity

With the Bluetooth-enabled assistant control panel, you can able to commission, start, stop, and monitor the drive, and reset faults from different devices such as tablets.

Save time, ease troubleshooting and improve drive performance with ABB smartphone apps

Better connectivity and user experience with Drivetune

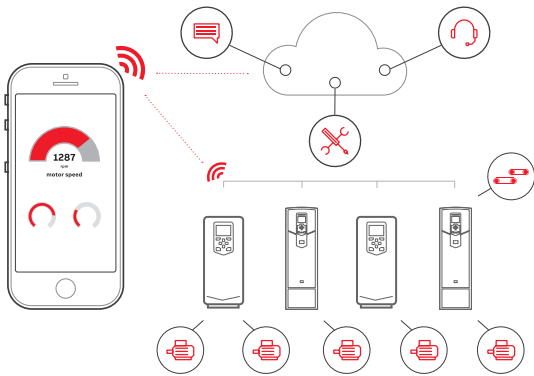

Easy and fast access to product information and support

Manage your drives and the process lines and machines they control



Easy access to cloud-based drive and process information from anywhere via an online connection



Start up, commission and tune your drive and application

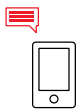

Simplified user guidance with instant access to drive status and configuration



Performance optimization via drive troubleshooting features and fast support

Services and support on the go with Drivebase

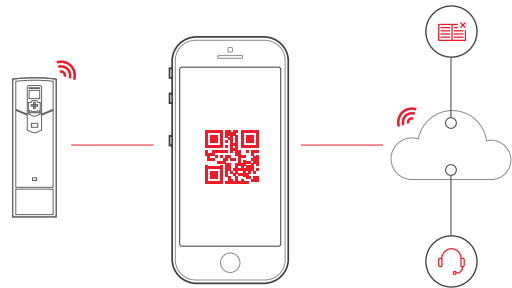

Search for support documents and contacts

Maintain and service all your installed drives on one or multiple sites



Get 6 months extra warranty for free by registering your drive with the Drivebase app



Access your product and service information in the cloud from anywhere



Access your drive's diagnostics data



Push notifications for critical product and service updates

Access information anywhere

Download the apps using the QR codes below or directly from the app stores



Drivetune for commissioning and managing drives

Drivebase for ensured reliability and reduced downtime on production sites

High protection for operation in harsh environments

The ACH580 can be installed in clean rooms, or even dusty and wet environments, thanks to the drive's wall-mountable construction in both IP21 and IP55 configurations. The cabinet-built variant comes with IP21 as standard and is also available with IP42 and IP54 protection classes for use in harsh environments.

The robust and protective design ensures that no additional enclosures or components, such as dust filters and fans, are needed. Overall, the harsh protection drives require smaller capital expenses by avoiding or advancing maintenance of external components, which in turn improves the reliability of the drive and the process.



Flange mounting

The ACH580-1 wall-mounted drive offers flange mounting as an option, separating the control electronics from the main circuit cooling airflow, saving space and ensuring optimal cooling. This results in better thermal management during panel installation and also reduces the overall enclosure size.



Advanced cooling

The simple and robust design of the ACH580-07 ensures reliable operation, even in harsh environments. The flange-mounting feature is standard for the cabinet-built ACH580 drive, which separates the heat-generating power electronics from the more sensitive control electronics. This extends the product's life.



du/dt filters

du/dt filtering suppresses inverter output voltage spikes and rapid voltage changes that stress motor insulation. Additionally, du/dt filtering reduces capacitive leakage currents and high-frequency emissions from the motor cable as well as high-frequency losses and bearing currents in

the motor. The need for du/dt filtering depends on the motor insulation. For information on the construction of the motor insulation, consult the manufacturer. More information on the du/dt filters can be found in the ACH580 hardware manual.

External du/dt filter for ACH580-01 and ACH580-04

ACH580 400 V	du/dt filter type * 3 filters included, dimensions apply to one filter.																
	Unprotected (IP00)			Protected to IP22				Protected to IP54									
	NOCH0016-60	NOCH0030-60	NOCH0070-60	NOCH0120-60*	FOCH0260-70	FOCH0320-50	FOCH0610-70	FOCH0875-70	NOCH0016-62	NOCH0030-62	NOCH0070-62	NOCH0120-62	NOCH0016-65	NOCH0030-65	NOCH0070-65	NOCH0120-65	BOCH-0880A-7
ACH580-01-02A7-4	x								x				x				
ACH580-01-03A4-4	x								x				x				
ACH580-01-04A1-4	x								x				x				
ACH580-01-05A7-4	x								x				x				
ACH580-01-07A3-4	x								x				x				
ACH580-01-09A5-4	x								x				x				
ACH580-01-12A7-4	x								x				x				
ACH580-01-018A-4		x								x				x			
ACH580-01-026A-4		x								x				x			
ACH580-01-033A-4			x								x				x		
ACH580-01-039A-4			x								x				x		
ACH580-01-046A-4			x								x				x		
ACH580-01-062A-4			x								x				x		
ACH580-01-073A-4				x								x				x	
ACH580-01-088A-4				x								x				x	
ACH580-01-106A-4				x								x				x	
ACH580-01-145A-4					x												
ACH580-01-169A-4					x												
ACH580-01-206A-4					x												
ACH580-01-246A-4					x												
ACH580-01-293A-4					x												
ACH580-01-363A-4						x											
ACH580-01-430A-4							x										
ACH580-04-505A-4								x									
ACH580-04-585A-4									x								
ACH580-04-650A-4										x							
ACH580-04-725A-4											x						
ACH580-04-820A-4												x					
ACH580-04-880A-4													x				

External du/dt filters for ACH580-07

ACH580 400 V	du/dt filter type * 3 filters included, dimensions apply to one filter.		
	BOCH-0880A-7	COF-01	COF-02
ACH580-07-0145A-4		x	
ACH580-07-0169A-4		x	
ACH580-07-0206A-4		x	
ACH580-07-0246A-4			x
ACH580-07-0293A-4			x
ACH580-07-0363A-4			x
ACH580-07-0430A-4			x
ACH580-07-0505A-4	x		
ACH580-07-0585A-4	x		
ACH580-07-0650A-4	x		
ACH580-07-0725A-4	x		
ACH580-07-0820A-4	x		
ACH580-07-0880A-4	x		

Dimensions and weights of the du/dt filters

du/dt filter	Height (mm)	Width (mm)	Depth (mm)	Weight (kg)
NOCH0016-60	195	140	115	2.4
NOCH0016-62/65	323	199	154	6
NOCH0030-60	215	165	130	4.7
NOCH0030-62/65	348	249	172	9
NOCH0070-60	261	180	150	9.5
NOCH0070-62/65	433	279	202	15.5
NOCH0120-60 ³⁾	200	154	106	7
NOCH0120-62/65	765	308	256	45
FOCH0260-70	382	340	254	47
FOCH0320-50	662	319	293	65
FOCH0610-70	662	319	293	65
FOCH0875-70	662	319	293	65
BOCH-0880A-7	400	248	456	18
COF-01	570	296	360	23
COF-02	570	360	301	23



Selection guide

IE4 synchronous reluctance motors

This table presents technical performance data for IE4 SynRM motors. Variant codes and construction details are based on the M3BP motor. Protection IP55, cooling IC 411, insulation class F, temperature rise class B. Motor values are given with an ACH580 drive supply.

Output kW	Motor type*	Product code	Motor efficiency %	Motor nominal current A	Motor nominal torque Nm	Motor weight Kg	Matched ACH580-01 drive for HVAC fan, pump and compressor use	Package efficiency** IES at nominal point (Pn) %	PDS*** IES2 efficiency class low limit %	Above IES2 low limit %	Frame size
3000 RPM / 100 Hz			400 V network								
1.5	M3AL90L4	3GAL092 507-_SB ²⁾	84.2	3.9	4.8	13	ACH580-01-04A1-4	82.1	76.2	7.7	R1
2.2	M3AL90LA4	3GAL092517-_SB ²⁾	85.9	5.6	7.0	13	ACH580-01-05A7-4	83.8	78.3	6.9	R1
3	M3AL100LB4	3GAL102527-_SB ¹⁾²⁾	88.6	9.5	9.6	23	ACH580-01-12A7-4	86.4	79.8	8.2	R1
4	M3AL112MB4	3GAL112327-_SB ¹⁾²⁾	89.9	13.6	12.7	33	ACH580-01-018A-4	87.7	81.1	8.1	R1
5.5	M3AL132SMA4	3GAL132217-_SC	90.9	12.6	17.5	41	ACH580-01-12A7-4	88.4	82.5	7.2	R1
7.5	M3AL132SMB4	3GAL132227-_SC	91.7	16.9	23.9	41	ACH580-01-018A-4	89.3	83.9	6.4	R2
11	M3AL132SMC4	3GAL132237-_SC	92.6	25	35.0	47	ACH580-01-026A-4	90.0	85.3	5.5	R2
11	M3BL160MLA4	3GBL162417-_SC	92.6	25.0	35.0	133	ACH580-01-026A-4	90.2	85.3	5.8	R2
15	M3AL132SMD4	3GAL132247-_SC	93.3	33.5	47.7	47	ACH580-01-039A-4	90.7	86.2	5.2	R3
15	M3BL160MLB4	3GBL162427-_SC	93.3	34.8	48.0	133	ACH580-01-039A-4	90.5	86.2	5.0	R3
18.5	M3BL160MLC4	3GBL162437-_SC	93.7	42.8	59.0	133	ACH580-01-046A-4	91.4	86.9	5.2	R3
22	M3BL180MLA4	3GBL182417-_SC	94.0	50.0	70.0	160	ACH580-01-062A-4	91.6	87.3	4.9	R4
30	M3BL200MLA4	3GBL202417-_SC	94.5	68.8	95.0	259	ACH580-01-073A-4	92.2	88.1	4.6	R4
37	M3BL200MLB4	3GBL202427-_SC	94.8	84.6	118	259	ACH580-01-088A-4	92.7	88.6	4.7	R5
45	M3BL225SMA4	3GBL222217-_SC	95.0	103	143	282	ACH580-01-106A-4	92.2	89.0	3.6	R5
55	M3BL225SMF4	3GBL222267-_SC	95.3	122	175	282	ACH580-01-145A-4	92.6	89.4	3.5	R6
1500 RPM / 50 Hz											
1.1	M3AL90LA4	3GAL092513-_SB ²⁾	81.4	2.9	7.0	13	ACH580-01-03A4-4	79.4	74.0	7.3	R1
1.5	M3AL90LB4	3GAL092523-_SB ²⁾	82.8	3.8	9.6	16	ACH580-01-04A1-4	80.7	76.2	5.9	R1
2.2	M3AL100LB4	3GAL102523-_SB ¹⁾²⁾	86.2	5.8	14.0	23	ACH580-01-07A3-4	84.0	78.3	7.3	R1
3	M3AL100LB4	3GAL102523-_SB ²⁾	85.5	7.1	19.1	23	ACH580-01-07A3-4	83.4	79.8	4.4	R1
4	M3AL112MB4	3GAL112323-_SB ¹⁾²⁾	88.0	10.6	25.5	33	ACH580-01-12A7-4	85.8	81.1	5.8	R1
5.5	M3AL132SMA4	3GAL132213-_SC	91.9	12.1	35.0	63	ACH580-01-12A7-4	89.6	82.5	8.6	R1
7.5	M3AL132SMB4	3GAL132223-_SC	92.6	16.2	47.7	63	ACH580-01-018A-4	90.1	83.9	7.4	R2
11	M3AL132SMC4	3GAL132233-_SC	93.3	24	70	69	ACH580-01-026A-4	90.6	85.3	6.2	R2
11	M3BL160MLA4	3GBL162413-_SC	93.3	24.9	70	160	ACH580-01-026A-4	90.9	85.3	6.6	R2
15	M3BL160MLB4	3GBL162423-_SC	93.9	33.7	95	177	ACH580-01-039A-4	91.3	86.2	5.9	R3
18.5	M3BL180MLA4	3GBL182413-_SC	94.2	42.0	118	177	ACH580-01-046A-4	92.0	86.9	5.9	R3
22	M3BL200MLF4	3GBL202463-_SC	94.5	49.1	140	304	ACH580-01-062A-4	92.2	87.3	5.6	R4
30	M3BL200MLA4	3GBL202413-_SC	94.9	66.7	191	304	ACH580-01-073A-4	92.6	88.1	5.1	R4
37	M3BL250SMF4	3GBL252263-_SC	95.2	82.0	236	428	ACH580-01-088A-4	93.1	88.6	5.1	R5
45	M3BL250SMG4	3GBL252273-_SC	95.4	99.5	286	428	ACH580-01-106A-4	92.8	89.0	4.3	R5
55	M3BL250SMA4	3GBL252213-_SC	95.7	121	350	454	ACH580-01-145A-4	93.1	89.4	4.1	R6
75	M3BL280SMA4	3GBL282213-_DC	96.0	173	478	639	ACH580-01-206A-4	93.6	90.0	4.0	R7
90	M3BL280SMB4	3GBL282223-_DC	96.1	202	573	639	ACH580-01-206A-4	93.7	90.2	3.9	R7
110	M3BL280SMC4	3GBL282233-_DC	96.3	245	699	697	ACH580-01-246A-4	93.5	90.5	3.3	R8
110	M3BL315SMA4	3GBL312213-_DC	96.3	244	702	873	ACH580-01-246A-4	94.0	90.5	3.9	R8
132	M3BL315SMB4	3GBL312223-_DC	96.4	290	842	925	ACH580-01-293A-4	94.0	90.7	3.6	R8
160	M3BL315SMC4	3GBL312233-_DC	96.6	343	1018	965	ACH580-01-363A-4	94.2	90.9	3.6	R9
200	M3BL315MLA4	3GBL312413-_DC	96.7	427	1272	1116	ACH580-01-430A-4	94.5	91.1	3.7	R9

¹⁾ Motor with restamped output required (option +002)

²⁾ Motor non-conformable with IE4 EE class

* Motor type M3AL = aluminum motor frame

* Motor type M3BL = cast iron motor frame

** Calculated package efficiency values for ACH580-01

***PDS = Power Drive System

Selection guide

IE4 synchronous reluctance motors

This table presents technical performance data for IE4 SynRM motors. Variant codes and construction details are based on the M3BP motor. Protection IP55, cooling IC 411, insulation class F, temperature rise class B. Motor values are given with an ACH580 drive supply.

Output kW	Motor type	Product code	Motor efficiency %	Motor nominal current A	Motor nominal torque Nm	Motor weight Kg	Suggested ACH580 drive for no overload pump use*	Package efficiency ** IES at nominal point (Pn) %	PDS*** IES2 efficiency class low limit %	Above IES2 low limit %	Frame size
3000 rpm											
55	M3BL225SMF4	3GBL 222267-_SC	95.3	122	175	282	ACH580-07-145A-4	92.6	89.4	3.5	R6
1500 rpm											
55	M3BL250SMA4	3GBL 252213-_SC	95.7	121	350	454	ACH580-07-145A-4	93.1	89.4	4.1	R6
75	M3BL280SMA4	3GBL 282213-_DC	96.0	173	478	639	ACH580-07-206A-4	93.6	90.0	4.0	R7
90	M3BL280SMB4	3GBL 282223-_DC	96.1	202	573	639	ACH580-07-206A-4	93.7	90.2	3.9	R7
110	M3BL280SMC4	3GBL 282233-_DC	96.3	245	699	697	ACH580-07-246A-4	93.5	90.5	3.3	R8
110	M3BL315SMA4	3GBL 312213-_DC	96.3	244	702	873	ACH580-07-246A-4	94.0	90.5	3.9	R8
132	M3BL315SMB4	3GBL 312223-_DC	96.4	290	842	925	ACH580-07-293A-4	94.0	90.7	3.6	R8
160	M3BL315SMC4	3GBL 312233-_DC	96.6	343	1018	965	ACH580-07-363A-4	94.2	90.9	3.6	R9
200	M3BL315MLA4	3GBL 312413-_DC	96.7	427	1272	1116	ACH580-07-430A-4	94.5	91.1	3.7	R9

¹⁾ Motor with restamped output required (option +002)

²⁾ Motor non-conformable with IE4 EE class

* Motor type M3AL = aluminum motor frame

* Motor type M3BL = cast iron motor frame

** Calculated package efficiency values for ACH580-07

***PDS = Power Drive System

Ultimate efficiency and reliability to optimize your system's total cost of ownership

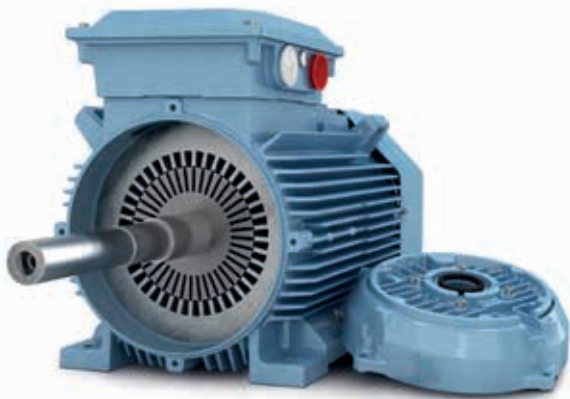

Traditional IE2 induction motor



IE4 synchronous reluctance motor SynRM

Losses

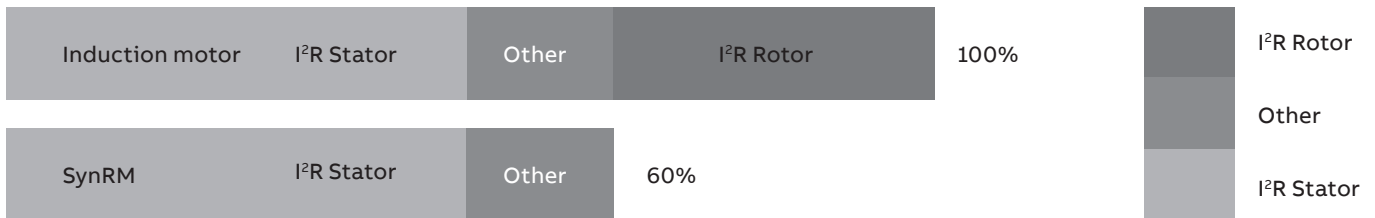

Innovation inside

The idea is simple. Take a conventional, proven stator technology and a totally new, innovative rotor design. Then combine them with a dedicated HVAC industry drive loaded with new, application-specific software. Finally, optimize the whole package for applications such as fans, pumps, compressors, air-handling units and chillers.

Magnet-free design

Synchronous reluctance technology combines the performance of a permanent magnet motor with the simplicity and service-friendliness of an induction motor. The new rotor has neither magnets nor windings, and suffers virtually no power losses. And because of identical footprints it is easy to replace an induction motor with a SynRM.

Superior reliability to minimize the cost of not running

IE4 synchronous reluctance motors have very low winding temperatures, which increases the reliability and life of the winding. More importantly, the cool synchronous reluctance rotor means significantly lower bearing temperatures – an important factor because bearing failures cause about 70 percent of unplanned motor outages.



Choose the motor for you HVAC application



Induction motors and the ACH580 form a reliable combination

Induction motors are used throughout the industry in many HVAC applications and in a wide range of environments. ACH580 drives fit perfectly together with this type of motor by providing comprehensive functionality, yet simple operation. IE3 and IE4 motors and our VSD provide a perfect foundation for energy efficiency, while delivering capabilities such as exceeding the nominal motor speed when maximum power is needed.



Permanent magnet motors and the ACH580 for smooth operation

Permanent magnet technology is used for improved motor characteristics in terms of energy efficiency and compactness. This technology is particularly well-suited for low-speed control applications, as they eliminate the need to use gearboxes. Even without speed or rotor position sensors, ACH580 drives can control most types of permanent magnet motors.



IE4 synchronous reluctance motors and the ACH580 for optimized energy efficiency

Our drive and motor pairings ensures your energy efficiency levels. The key is in the rotor design. Combining the ACH580's control technology with our synchronous reluctance motors (SynRM) will give you a motor and a drive package that ensures energy efficiency, reduces motor temperatures and provides a significant reduction in motor noise.

Services to match your needs

Your service needs depend on your operation, life cycle of your equipment and business priorities. We have identified our customers' four most common needs and defined service options to satisfy them. What is your choice to keep your drives at peak performance?

Is uptime your priority?

Keep your drives running with precisely planned and executed maintenance.

Example services include:

- Life Cycle Assessment
- Installation and Commissioning
- Spare Parts
- Preventive Maintenance
- Reconditioning
- ABB Drive Care agreement
- Drive Exchange

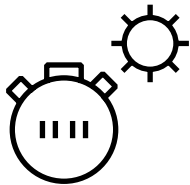

Operational efficiency

Is rapid response a key consideration?

If your drives require immediate action, our global network is at your service.

Example services include:

- Technical Support
- On-site Repair
- Remote Support
- Response time agreements
- Training

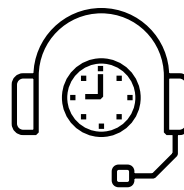

Rapid response

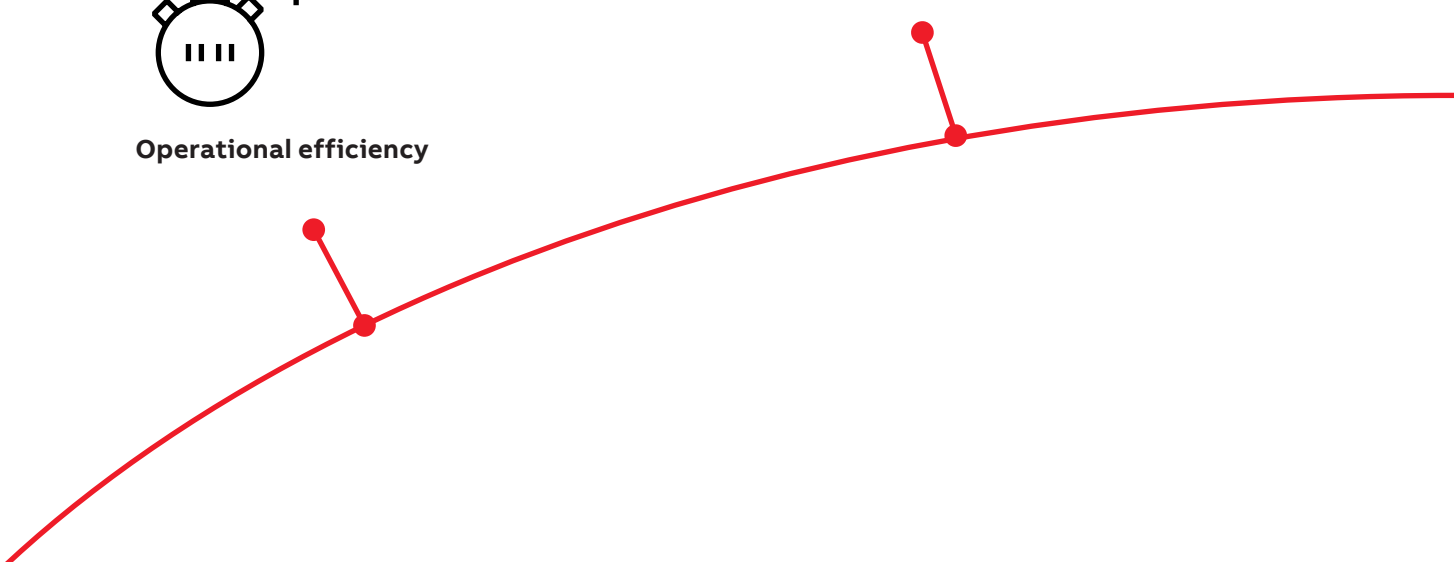

Drives service

Your choice, your future

The future of your drives depends on the service you choose.

Whatever you choose, it should be a well-informed decision. No guesswork. We have the expertise and experience to help you find and implement the right service for your drive equipment. You can start by asking yourself these two critical questions:

- Why should my drive be serviced?
- What would my optimal service options be?

From here, you have our guidance and full support along the course you take, throughout the entire lifetime of your drives.

Need to extend your assets' lifetime?

Maximize your drive's lifetime with our services.

Example services include:

- Life Cycle Assessment
- Upgrades, Retrofits and Modernization
- Replacement, Disposal and Recycling

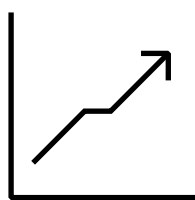

Life cycle management

Your choice, your business efficiency

ABB Drive Care agreement lets you focus on your core business. A selection of predefined service options matching your needs provides optimal, more reliable performance, extended drive lifetime and improved cost control. So you can reduce the risk of unplanned downtime and find it easier to budget for maintenance.

We can help you more by knowing where you are!

Register your drive at www.abb.com/drivereg for extended warranty options and other benefits.

Option code	Description
+P931	ACH580 extension of warranty to 36 months from delivery
+P932	ACH580 extension of warranty to 60 months from delivery

Is performance most critical to your operation?

Get optimal performance out of your machinery and systems.

Example services include:

- Advanced services
- Engineering and Consulting
- Inspection and Diagnostics
- Upgrades, Retrofits and Modernization
- Workshop Repair
- Tailored services

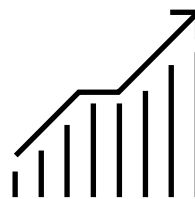

Performance improvement

A lifetime of peak performance

You're in control of every life cycle phase of your drives. At the heart of drive services is a four-phase product life cycle management model. This model defines the services recommended and available throughout drives lifespan.

Now it's easy for you to see the exact service and maintenance available for your drives.

ABB drives life cycle phases explained:

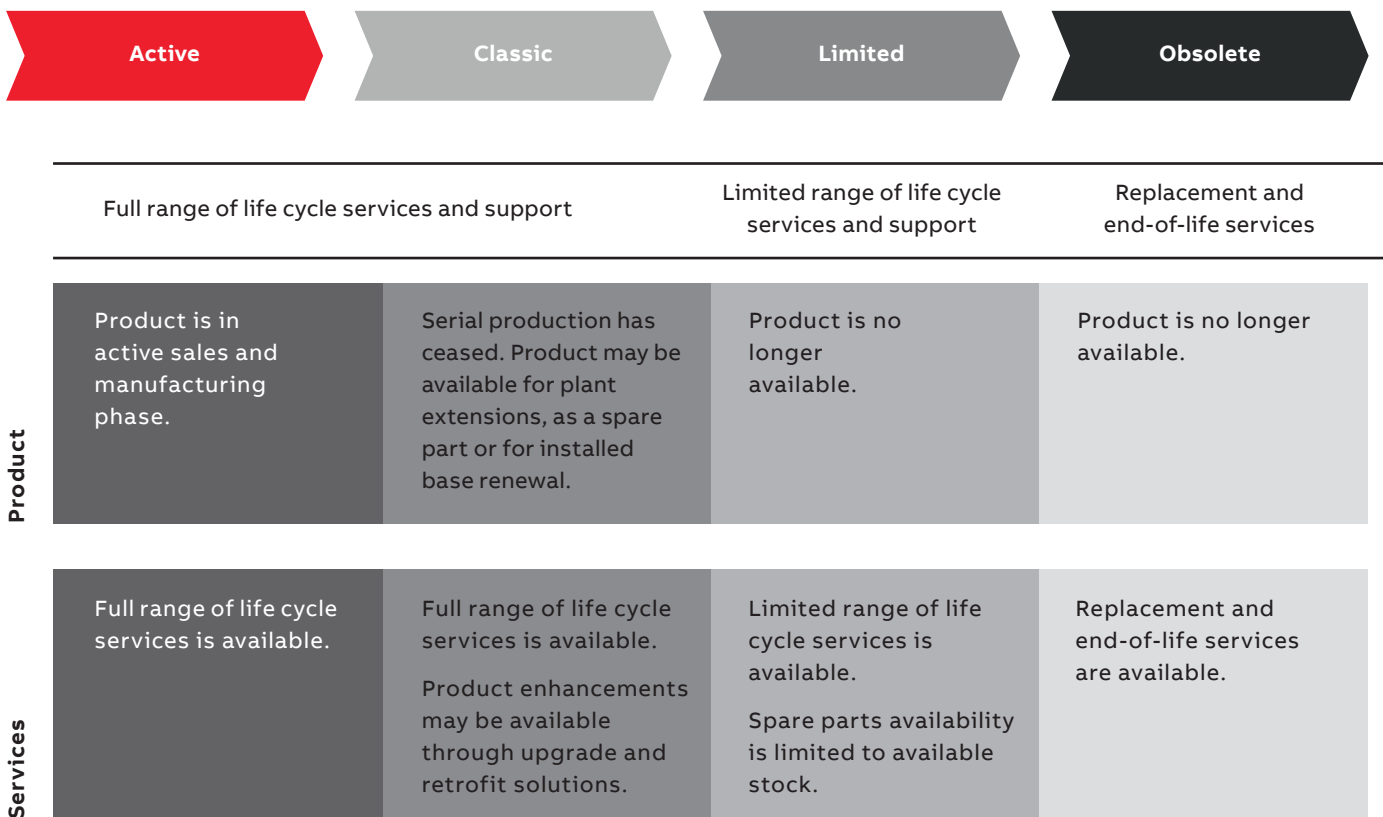

Keeping you informed

We notify you every step of the way using life cycle status statements and announcements.

Your benefit is clear information about your drives' status and precise services available. It helps you plan the preferred service actions ahead of time and make sure that continuous support is always available.

Step 1

Life Cycle Status Announcement

Provides early information about the upcoming life cycle phase change and how it affects the availability of services.

Step 2

Life Cycle Status Statement

Provides information about the drive's current life cycle status, availability of product and services, life cycle plan and recommended actions.

—
For more information, please contact
your local ABB representative or visit

new.abb.com/drives/HVAC
www.abb.com/drivespartners
www.abb.com/motors&generators

ACH580-01 drives hardware manual



ACH580-04 drives hardware manual



ACH580-07 drives hardware manual



ACH580 drives HVAC control program firmware manual

