



V60 Pro

# User Manual

Please read the user manual  
carefully before use and keep it properly.

---

# Welcome

**Welcome to use the Verefa robot vacuum cleaner. We hope you can have a pleasant experience!**

**If you have any questions or suggestions, discover our contact information at the bottom of the device to contact us, and we can provide you with the support you need.**

# Table of Contents

|   |  |    |
|---|--|----|
| <b>1. Safety Instructions</b>             | Important Safety Instructions                          | 01 |
|   | 2.1 What's in the Box                                  | 04 |
| <b>2. Product Overview</b>                | 2.2 Product Anatomy (Including Buttons and Indicators) | 05 |
|   | 3.1 Important Tips Before Use                          | 09 |
| <b>3. Installation</b>                    | 3.2 Get started  | 09 |
|   | 4.1 Main Functions                                     | 13 |
| <b>4. Operating Instructions</b>          | 4.2 Network Functions                                  | 15 |
|   | 4.3 Other Functions                                    | 16 |
|   | 5.1 Routine Maintenance                                | 18 |
| <b>5. Maintenance and Troubleshooting</b> | 5.2 Troubleshooting                                    | 23 |
|   | 5.3 FAQs   | 26 |
|   | Basic Parameters                                       | 28 |
| <b>6. Declaration</b>                     | Energy Saving and Battery                              | 29 |
|   | Customer Service                                       | 30 |

# 1. Safety Instructions

Before using the product, follow these basic safety precautions:

- Read everything in the manual carefully and use the product according to the instructions in the manual.
- Keep the manual for future reference.
- If you need to transfer the product to a third party, please attach the manual with the product.
- Any operation that does not conform to the manual may result in serious personal injuries or damage to the product itself.
- If the manual is missing, please contact the local dealer or our customer service to obtain the electronic version.

## IMPORTANT SAFETY INSTRUCTIONS

When using an electrical appliance, basic precautions should always be followed, including the following :

### READ ALL INSTRUCTIONS BEFORE USING (THIS APPLIANCE)

- This appliance can be used by children aged from 8 years and above and persons with reduced physical, sensory or mental capabilities or lack of experience and knowledge if they have been given supervision or instruction concerning use of the appliance in a safe way and understand the hazards involved. Children shall not play with the appliance. Cleaning and user maintenance shall not be made by children without supervision.

**WARNING** – To reduce the risk of fire, electric shock, or injury :

- Do not leave appliance when plugged in. Unplug from outlet when not in use and before servicing.
- Do not use outdoors or on wet surfaces.
- Do not allow to be used as a toy. Close attention is necessary when used by or near children.
- Use only as described in this manual. Use only manufacturer's recommended attachments.
- Do not use with damaged cord or plug. If appliance is not working as it should, has been dropped, damaged, left outdoors, or dropped into water, return it to a service center.
- Do not pull or carry by cord, use cord as a handle, close a door on cord, or pull cord around sharp edges or corners. Do not run appliance over cord. Keep cord away from heated surfaces.
- Do not unplug by pulling on cord. To unplug, grasp the plug, not the cord.
- Do not handle plug or appliance with wet hands.
- Do not put any object into openings. Do not use with any opening blocked; keep free of dust, lint, hair, and anything that may reduce air flow.
- Keep hair, loose clothing, fingers, and all parts of body away from openings and moving parts.
- Turn off all controls before unplugging.
- Do not use to pick up flammable or combustible liquids, such as gasoline, or use in areas where they may be present.
- Do not pick up anything that is burning or smoking, such as cigarettes, matches, or hot ashes.
- Do not use without dust bag and/or filters in place.
- Unplug before connecting dust bag.



- If you do not use this product for a long time, please turn off the robot after it is fully charged and put it in a cool and dry place. Charge it at least once every three months to avoid over discharge of the battery.
- For use only with S102 docking station.(Auto-Empty Charging Base)

### **Supplement for Robot Vacuum :**

- Place the cords from other appliances out of the area to be cleaned.
- Do not operate the vacuum in a room where an infant or child is sleeping.
- Do not operate the vacuum in an area where there are lit candles or fragile objects on the floor to be cleaned.
- Do not operate the vacuum in a room that has lit candles on furniture that the vacuum may accidentally hit or bump into.
- Do not allow children to sit on the vacuum.
- Do not use the vacuum on a wet surface.

WARNING: Read all safety warnings and instructions. Failure to follow the warnings and instructions may result in electric shock, fire and/or serious injury.

- Prevent unintentional starting. Ensure the switch is in the off-position before connecting to battery pack, picking up or carrying the appliance. Carrying the appliance with your finger on the switch or energizing appliance that have the switch on invites accidents.
- Recharge only with the charger specified by the manufacturer. A charger that is suitable for one type of battery pack may create a risk of fire when used with another battery pack.
- Use appliances only with specifically designated battery packs. Use of any other battery packs may create a risk of injury and fire.
- Under abusive conditions, liquid may be ejected from the battery; avoid contact. If contact accidentally occurs, flush with water. If liquid contacts eyes, additionally seek medical help. Liquid ejected from the battery may cause irritation or burns.
- Do not use a battery pack or appliance that is damaged or modified. Damaged or modified batteries may exhibit unpredictable behavior resulting in fire, explosion or risk of injury.
- Do not expose a battery pack or appliance to fire or excessive temperature. Exposure to fire or temperature above 130 °C may cause explosion. The temperature of 130°C may be replaced by the temperature of 265°F.
- Follow all charging instructions and do not charge the battery pack or appliance outside of the temperature range specified in the instructions. Charging improperly or at temperatures outside of the specified range may damage the battery and increase the risk of fire.
- Have servicing performed by a qualified repair person using only identical replacement parts. This will ensure that the safety of the product is maintained. This appliance contains batteries that are only replaceable by skilled persons.
- Do not modify or attempt to repair the appliance or the battery pack (as applicable) except as indicated in the instructions for use and care.
- Before using this appliance, pick up objects like clothing and loose paper. Lift up cords for blinds or curtains. Move power cords and sharp, pointed, or fragile objects out of the way. If this device passes over a power cord and drags it, an object could be pulled off a table or shelf.

## Battery and charging

- The auto-empty base must be removed from the socket-outlet before cleaning or maintaining the appliance.

**WARNING:** For the purposes of recharging the battery, only use the auto-empty base (model: SD01 & SD02) provided with this appliance.

- The auto-empty base only for charging Li-ion battery (Max. 2600mAh) of robot cleaner.
- Do not charge non-rechargeable battery.
- The appliance and battery use and storage, and charging system during charging in ambient temperature range 4 °C ~ 40 °C.
-  For indoor use only.

## Polarization instructions :

- To reduce the risk of electric shock, this appliance has a polarized plug (one blade is wider than the other). This plug will fit in a polarized outlet only one way. If the plug does not fit fully in the outlet, reverse the plug. If it still does not fit, contact a qualified electrician to install the proper outlet. Do not change the plug in any way.
- Battery type of remote controller: AAA
- Non-rechargeable batteries are not to be recharged
- Different types of batteries or new and used batteries are not to be mixed
- Batteries are to be inserted with the correct polarity
- Exhausted batteries are to be removed from the appliance and safely disposed
- If the appliance is to be stored unused for a long period, the batteries are removed.
- The supply terminals are not to be short-circuited.

## SAVE THESE INSTRUCTIONS

This equipment has been tested and found to comply with the limits for a Class B digital device, pursuant to part 15 of the FCC Rules. These limits are designed to provide reasonable protection against harmful interference in a residential installation. This equipment generates, uses and can radiate radio frequency energy and, if not installed and used in accordance with the instructions, may cause harmful interference to radio communications. However, there is no guarantee that interference will not occur in a particular installation. If this equipment does cause harmful interference to radio or television reception, which can be determined by turning the equipment off and on, the user is encouraged to try to correct the interference by one or more of the following measures:

- Reorient or relocate the receiving antenna.
- Increase the separation between the equipment and receiver.
- Connect the equipment into an outlet on a circuit different from that to which the receiver is connected.
- Consult the dealer or an experienced radio/TV technician for help.

**MODIFICATION:** Any changes or modifications not expressly approved by the grantee of this device could void the user's authority to operate the device.

## 2. Product Overview

### 2.1 What's in the Box

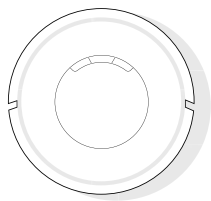

Robot Vacuum  
(hereinafter referred to as the Robot)

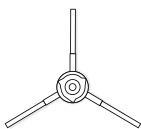

Side Brush (x1)



Cleaning Brush  
(In the dust box)



Remote Control

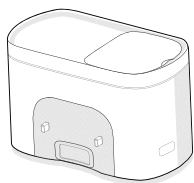

Auto-Empty Charging Base  
(hereinafter referred to as the Charging Base)  
(with dust bag pre-installed)

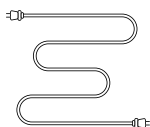

Power Cable

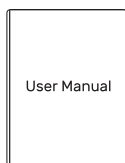

User Manual and  
Other Documents

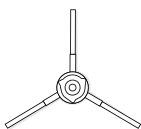

Additional Side  
Brush (x1)

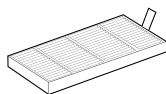

Additional Filter (x1)



Cable Ties (x5)

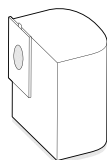

Additional Dust  
Bags (x2)

## 2.2 Product Anatomy (Including Buttons and Indicators)

### A) Robot Vacuum

#### Top View

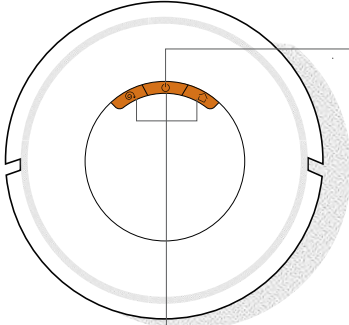

#### Button

 Power button

- **Turn On/Off** : Press and hold for 3 seconds to power on or off.

- **Auto Cleaning** : After power-on, press to start Auto Cleaning.

 Spot Cleaning button

- **Spot Cleaning** : Press to start Spot Cleaning.

 Recharge button

- **Recharge** : Press to start recharging.

- **Manual Emptying** : Press to start manual dust collection during charging.



- **Reset Wi-Fi** : Press and hold both buttons for 3 seconds to reset Wi-Fi.

- Press any button to pause during cleaning or recharging.

#### Robot status indicator light

**White** : Normal power

**Red** : Low power or Error

**Pulsing White** : Charging

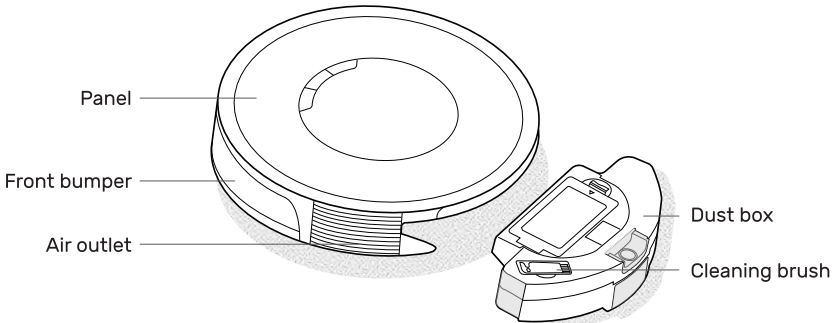

## Bottom View

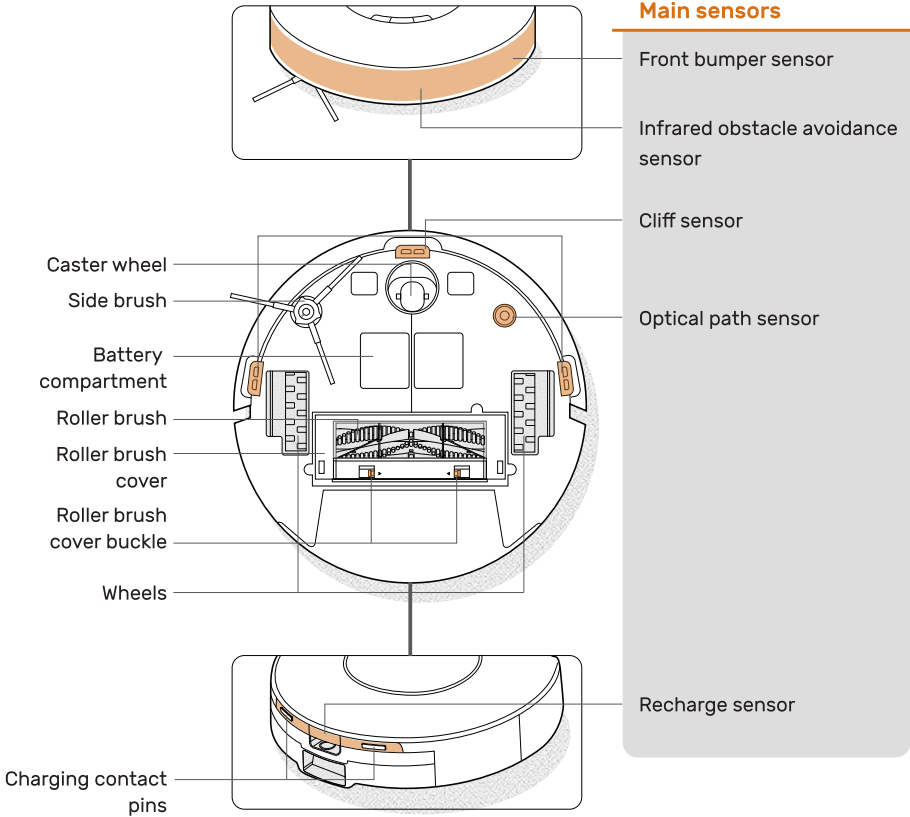

## Dust box

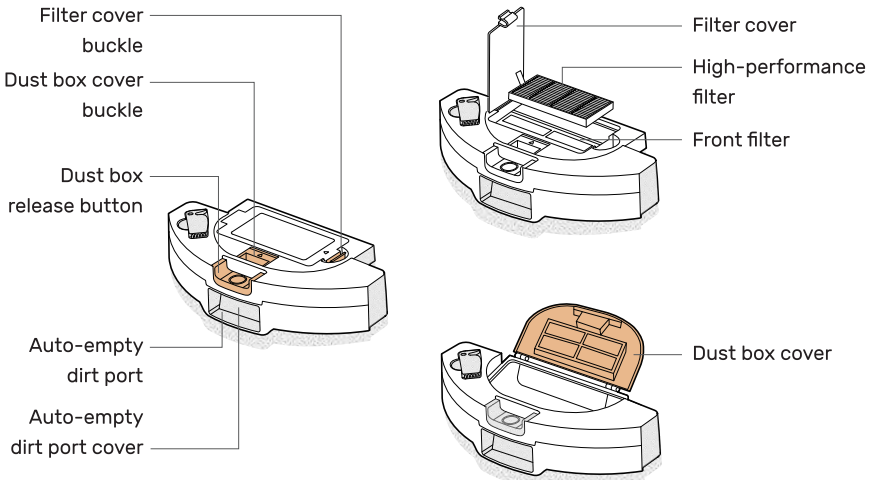

## B) Auto-Empty Charging Base (referred to as the Charging Base)

### Front View

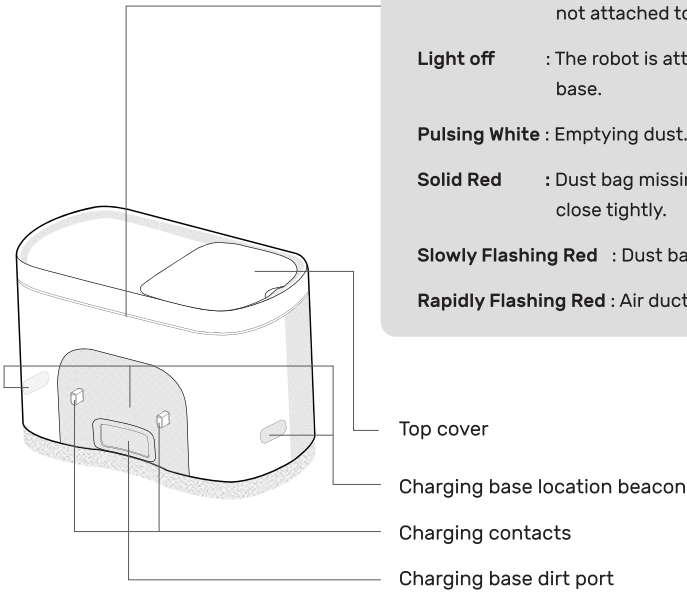

### Status indicator light (in power-on state)

- Solid White** : Connected to power, but the robot is not attached to the charging base.
- Light off** : The robot is attached to the charging base.
- Pulsing White** : Emptying dust.
- Solid Red** : Dust bag missing or top cover not close tightly.
- Slowly Flashing Red** : Dust bag needs to be replaced.
- Rapidly Flashing Red** : Air duct blocked.

### Back View

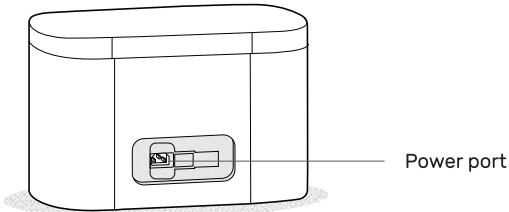

### Top View

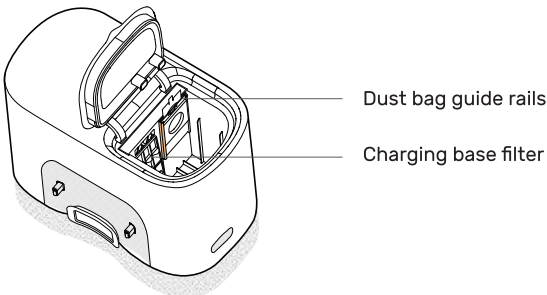

**Bottom View**

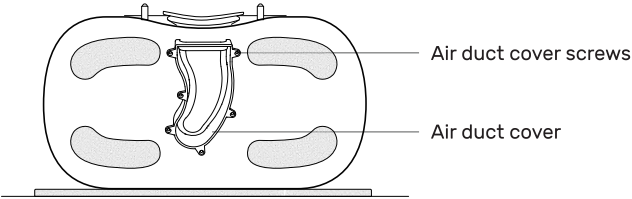

**C) Remote control**

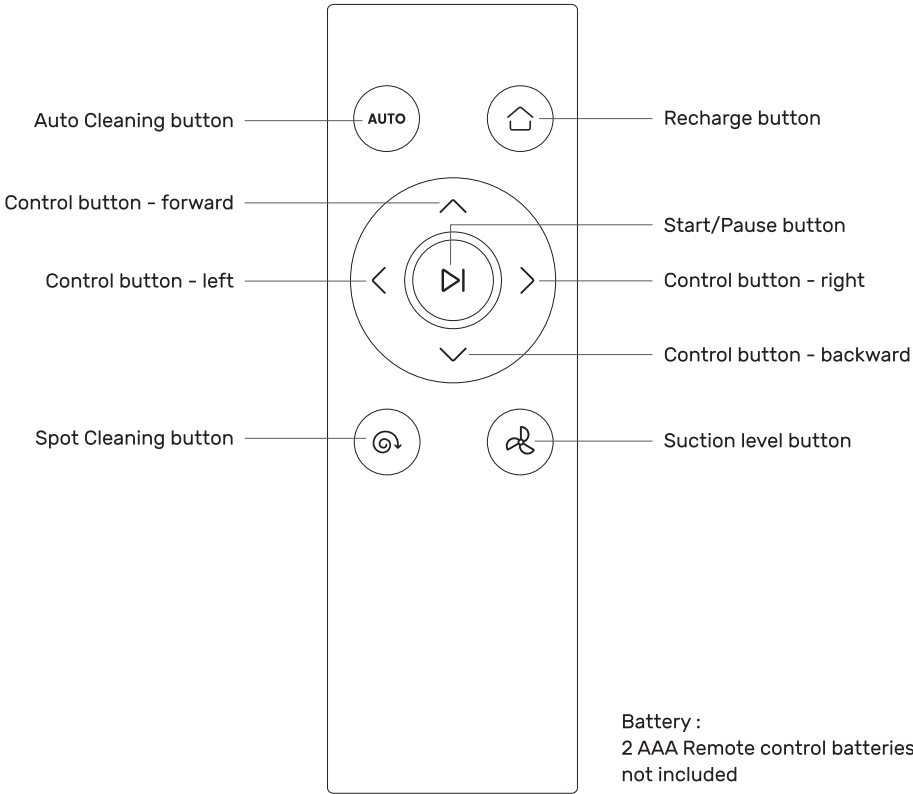

## 3. Installation

### 3.1 Important Tips Before Use

#### Prepare your home environment

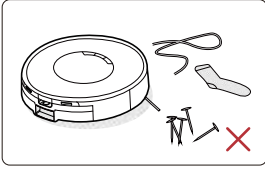

- 1 Before use, clear up the mess especially wires on the floor that may be wrapped around the robot. Remove items that are fragile, valuable, potentially hazardous and easy to fall. Avoid any damage to persons or property caused by being entangled, stuck, dragged or knocked over by the robot.

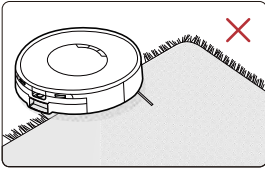

- 2 Fold tasseled edges of rugs underneath to prevent tangling the robot. Avoid cleaning rugs with very dark color or thickness exceeding 12.7 mm.

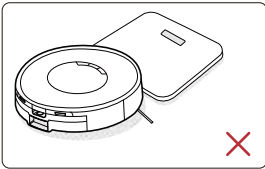

- 3 The robot may climb on top of objects less than 20mm in height. Remove these objects if possible.

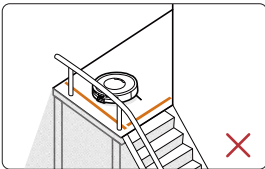

- 4 When using the robot in specific areas with suspended environment or dangerous areas, such as fireplace or exhaust port, it is recommended to place physical barriers instead of magnetic boundary strips to prevent damage to your body or property caused by accidental fall or entry of the robot.

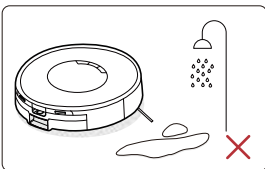

- 5 During cleaning, ensure that the robot is kept away from wet areas and viscous substances.

- 6 The robot may get stuck or encounter some obstacles during the first few times of cleaning, please follow the robot to observe and resolve any problems that may occur.

### 3.2 Get Started

#### 1) Remove protective items

Before use, remove any protective strips or films on the robot.

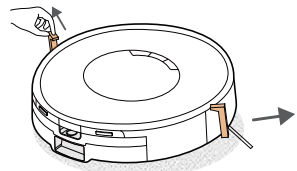



## 2) Install side brush

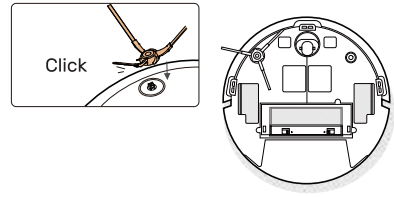

## 3) Place the charging base, connect the power supply and charge the robot

- 1 Connect the power cable and organize the power cables with the cable ties.

**△ Note :**

- Power cable on your floor may entangle the robot, resulting in power failure or jamming of the robot.

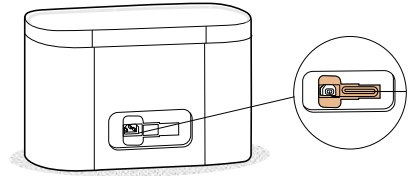

- 2 Place the charging base and power it on.

- Place the charging base in an easy-to-access position for the robot.

**△ Note :**

- Ensure that no objects are placed within 1.5m in front of the charging base and 0.5m from both sides.
- Do not cover the signal transmitting area of the charging base with any object.
- Avoid direct sunlight, which will affect the recharge effect.

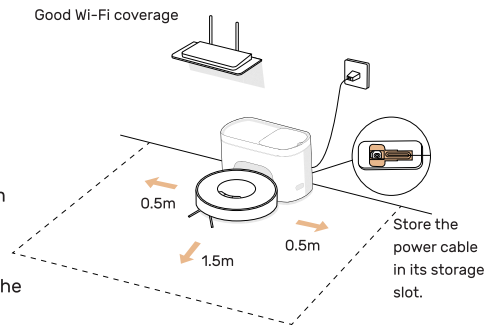

- Place the charging base on a level, non-slip, hard surface and against a wall.

**△ Note :**

- To avoid recharging failure caused by position change, do not put the charging base on a carpet or blanket.

- Always connect the charging base to the power supply. Ensure that it is located in a place with continuous Wi-Fi network and good network performance.

**△ Note :**

- Always keep the charging base plugged in, otherwise the robot will not return automatically.
- To return to the charging base smoothly after cleaning, it is recommended to start cleaning from the charging base. Do not move the charging base during cleaning.

- 3 Connect the robot to the charging base and turn it on.
- After connecting to the power supply, attach the robot to the charging base by aligning the charging contact pins. The robot will turn on automatically.

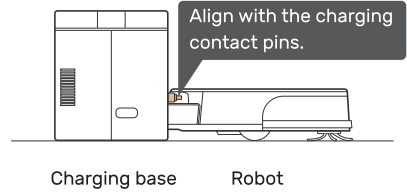

**Note :**

- When the battery level is insufficient to turn on the robot, place the robot on the charging base for a period of time, and the device will turn on automatically.
- If the robot is not on the charging base, press and hold the power button for 3 seconds to turn it on.

- 4 Fully charged.
- Fully charge the robot before first use.



**Note :**

- It is recommended to charge the robot for at least 4-6 hours before first use. The robot will not start or return for recharge without enough power.

#### 4) Connect to mobile client

**Note :**

- Make sure your smartphone is running iOS 9.0 (or above) or Android 5.0 (or above).
- Make sure the 2.4GHz band wireless signal is enabled on your wireless router and the signal is strong.
- To ensure better connection quality, please turn on the Bluetooth of your mobile phone.

- 1 Download the app.
- Search for the "Verefa Life" app in the app store. Then download and install it.



- 2 Reset Wi-Fi.
- Press and hold both buttons (🌀 Spot Cleaning button and 🏠 Recharge button) for 3 seconds until you hear the voice prompt. The three indicators on the robot start to flash slowly, indicating that the robot is ready for pairing.

### 3 Add a device.

- Open the app and follow the prompts to register or log in your account.
- Go to the home page of the app. Tap "+" in the upper right corner of the page to enter the "Add Device" page.
- Follow the on-screen instructions to connect with the robot.

#### ⚠ Note :

- Only the 2.4GHz band is supported for the Wi-Fi connection.
- As the app will be updated from time to time, the actual operation may be different from the above descriptions. Always follow the instructions in your app to complete the Wi-Fi connection.
- If the network configuration fails, reset Wi-Fi and repeat the above operations.

### 5) Start cleaning

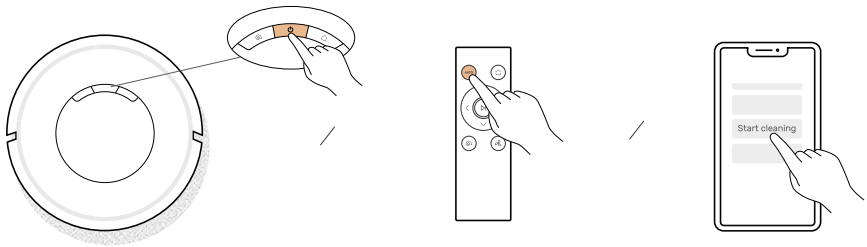

# 4. Operating Instructions

## 4.1 Main functions

### ● Turn on/off

- Press and hold the power button for 3 seconds to turn on the robot. The power indicator lights up. Press and hold the power button for 3 seconds again, and the robot will turn off.

⚠ Note :

- The robot cannot be turned off during charging.

### ● Start cleaning (Auto cleaning)

- Press the power button, and the robot will clean your rooms in sequence, following a Z-shaped cleaning method. Then it will clean along the walls in an orderly and efficient way. After cleaning, the robot will automatically return to the charging base for charging.

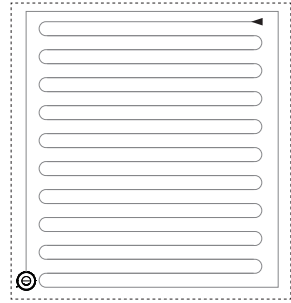

⚠ Note :

- If the power is too low to start cleaning, charge the robot first and then start cleaning.
- If the power is insufficient during cleaning, the robot will automatically return to the charging base for charging. After fully charged, it will resume cleaning from where it left off.
- If the cleaning area is less than 4 m<sup>2</sup>, the robot will clean twice by default.
- Please tidy up all wires on your floor (including the power cable of the charging base) before cleaning to avoid power failure and damage to the items or wires caused by dragging during cleaning.

### ● Pause/resume/sleep

- When the robot is working, press any button to pause it, and press the power button to continue cleaning.
- If standby exceeds 10 minutes, the robot will automatically enter the sleep mode. In the sleep mode, the power indicators are all off. Press any button to wake up the robot in sleep mode.

⚠ Note :

- If the robot is placed back to the charging base for charging, the current cleaning task will be ended.
- To continue cleaning task, place the robot in its original position to avoid path confusion.
- The robot will not enter the sleep mode during charging.

## ● Recharge

- **Automatic mode:** When the cleaning is completed or the battery is low during auto cleaning, the robot will automatically return to the charging base to charge.
- **Manual mode :** When the cleaning is paused, press the recharge button to start recharge, or enable it in the app.

### ⚠ Note :

- If the robot fails to return to the charging base, manually place the robot back to the charging base for charging.
- The indicator light will pulse white when the robot is being charged.

## ● Spot cleaning

- In standby mode or when the cleaning is paused, press the Spot cleaning button to start Spot Cleaning. The robot will clean a specific area with a diameter of 1.2m in a spiral pattern. After cleaning, the robot will automatically return to the starting point and finish the work.

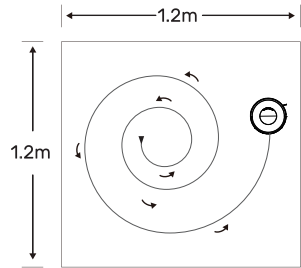

### ⚠ Note :

- Starting spot cleaning when there are other tasks will directly end the previous cleaning task.

## ● Schedule cleaning (only set via the app)

- You can schedule cleaning in the app. The robot will automatically start cleaning at the specified time and automatically return to the charging base after cleaning.

### ⚠ Note :

- When the scheduled time arrives during a cleaning session, the last cleaning task will be ended.

## ● Suction level

- For best cleaning effect, select different suction levels according to your needs.
- The greater the suction, the shorter the cleaning time and higher the noise.
- It can be set with the remote control and in the app.

## ● Auto-boost (only set via the app)

- During cleaning, the robot will automatically increase the suction power if it detects that stronger power is needed to ensure the best clean, such as thick carpets and hard-to-clean messes.
- This function will reduce the cleaning time and increase the noise level. If the increased noise disturbs you, you can disable this feature in the app.

### ● Auto-Empty dirt

#### - Auto emptying :

- After cleaning, the robot will return to the charging base, and the robot will automatically empty the dust box according to the emptying frequency set in the app.
- The emptying frequency can be adjusted in the app.

#### - Manual emptying :



- When the robot is connected to the charging base, you can press the recharge button of the robot or remote control to start manual emptying.

#### ⚠ Note :

- If auto emptying is not needed, disable this feature in the app.

## 4.2 Network functions

### ● Reset Wi-Fi

- If your mobile phone cannot connect to the robot (such as configuration or password change of your router), try to reset the Wi-Fi and reconnect to the network.
- Press and hold both buttons (  Spot Cleaning button and  Recharge button) for 3 seconds until you hear the voice prompt. The three indicators flash slowly, indicating that the robot is ready for pairing.
- For detailed Wi-Fi setup instructions, refer to "Installation > Connect to mobile client" in this manual.

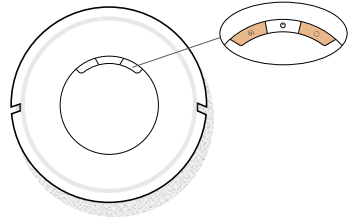

### ● Mobile client functions

- You can remotely control your robot through the mobile application.
- With the app, you can access more features such as schedule cleaning, find the robot, review the status and cleaning records.
- For specific Wi-Fi setup instructions, refer to "Installation > Connect to mobile client" in this manual.

#### ⚠ Note :

- Due to continuous development and upgrading of the app, functions and details may be slightly adjusted. Please refer to the actual version.

## 4.3 Other functions

### Find my robot

- If your robot is stuck somewhere, you can find it through the "Find my Robot" function in the app.

### Force restart system

- When the button does not respond or cannot be turn off, please try to restart the system.
- When not being charged, press and hold the power button for 10 seconds to force turn off, and then press and hold the power button for 3 seconds to turn on.

### Restore factory settings

- If the system cannot be used normally after resetting, please try to restore the factory settings.
- When not being charged, press and hold both the power button and the recharge button for 8 seconds at the same time until you hear the prompt tone.
- The robot will clear all information and settings. At this time, the user needs to reconfigure the settings (including the network settings).

### Magnetic boundary strip (sold separately)

- With the magnetic boundary strip, the robot can identify and avoid entering a specific area. For example, place the magnetic boundary strip in front of the door to prevent the robot from entering a room, or place the boundary strip around any pet drinking basin, toy area or complex wires to prevent the robot from crossing in.

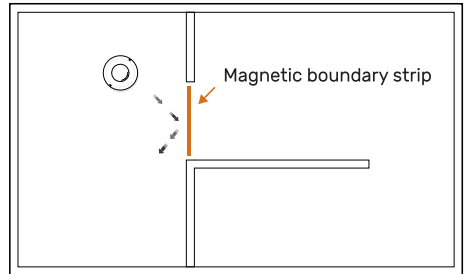

- 1 Identify the area to be isolated with magnetic boundary strip. Cut the boundary strip to a shorter length. Be sure to correctly measure the length before cutting. Keep a distance of at least 5cm from the separated items and areas to avoid your robot crossing over and touching them.

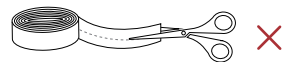
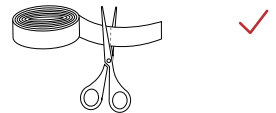

- 2 Place the magnetic boundary strip flat on the floor. Use an adhesive tape if it needs to be fixed.

⚠ Note :

- Ensure that the magnetic boundary strip is placed flat and on the same surface of your robot.
- If the magnetic boundary strip is rolled up, remove and then re-apply on the floor with adhesive tape. Otherwise the boundary strip may not work well.
- This function can only be used to divide the area, not to block any dangerous area.
- Do not place the magnetic boundary strip under any thick carpet, otherwise the robot vacuum cleaner may not recognize the boundary strip.

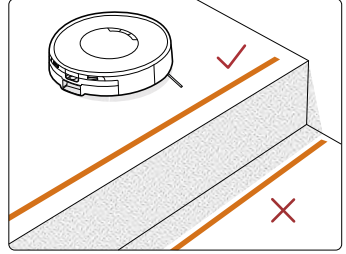
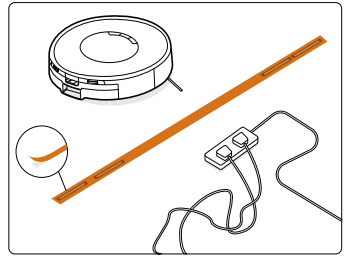



# 5. Maintenance and Troubleshooting

## 5.1 Routine maintenance

Please turn off and unplug the power cable before cleaning and maintaining the product. For best performance, refer to the following table for routine maintenance.

| Parts                                       | Maintenance frequency | Replacement frequency |
|---|-----------------------|-----------------------|
| Dust box                                    | Monthly               | -                     |
| Filter                                      | Weekly                | Every 3 months        |
| Roller brush                                | Monthly               | Every 6-12 months     |
| Roller brush cover                          | Monthly               | Every 3-6 months      |
| Side brush                                  | Monthly               | Every 3-6 months      |
| Caster Wheel                                | Monthly               | -                     |
| Wheel                                       | Monthly               | -                     |
| Sensors                                     | Monthly               | -                     |
| Charging contact pins and charging contacts | Monthly               | -                     |
| Dust bag                                    | Monthly               | Every month           |
| Charging base filter                        | Monthly               | -                     |
| Charging base dirt port                     | Monthly               | -                     |
| Charging base air duct                      | In case of blockage   | -                     |

 **Note :**

- If pets are kept, the frequency of parts maintenance should be increased to twice per cycle.
- The replacement frequency may vary depending on the actual situation. If visible or abnormal wear occurs, replace the parts.

### 1) Clean dust box and the filter

- 1 Press the dust box release button to take out the dust box.
- 2 Open and empty the dust box.
  - Use a cleaning brush to gently clean the inner cavity of dust box, the front filter of the dust box cover, the Auto-empty dirt port and the Auto-empty dirt port cover.
- 3 Close the dust box cover, press the filter cover buckle to open the filter cover, and take out the filter.
- 4 Thoroughly flush the dust box and filter with clean water.
- 5 Completely dry the dust box and filter and replace them.

**△ Note :**

- Be sure to dry the filter of the dust box thoroughly before use, so as to ensure normal operation and service life.
- Do not put the incomplete dust box into the robot, so as to avoid mistakenly triggering the cleaning, which will block the air duct of the robot or damage the fan.
- Do not put the dust box or filter into a dishwasher for cleaning.

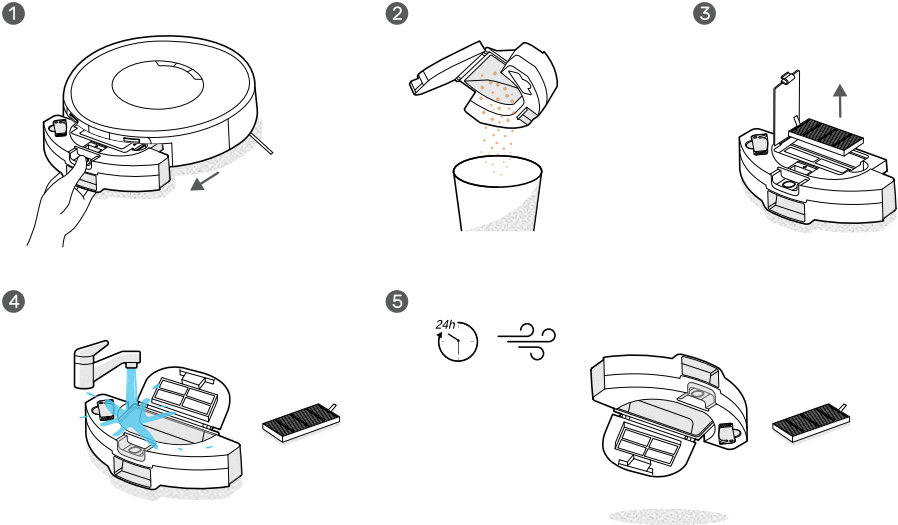

## 2) Clean roller brush and roller brush cover

- 1 Press and hold the roller brush cover buckles on both sides inward, and take out the roller brush cover and roller brush.
- 2 Cut off the hair wound on the roller brush with the blade of the cleaning brush.
- 3 The roller brush bearing on the side of the roller brush can be removed to clear any hair wound in the gap.
- 4 Clean the dirt on the roller brush cover.
- 5 Install the roller brush and the roller brush cover back.

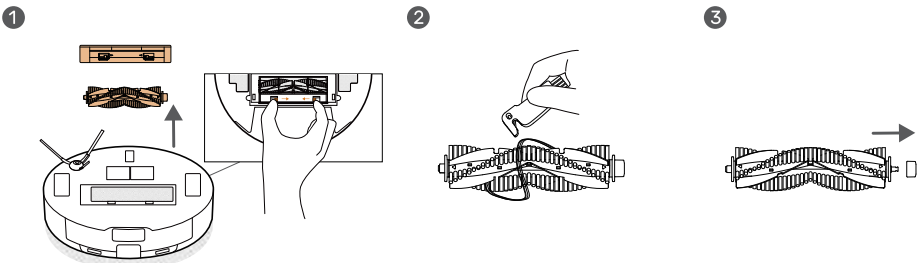

4

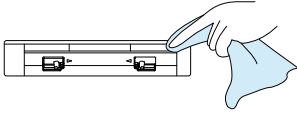

5

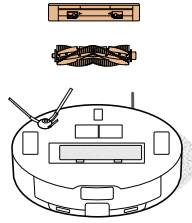

### 3) Clean side brush

- 1 Pull out the side brush.
- 2 Clean the side brush with a cleaning brush and install it back.

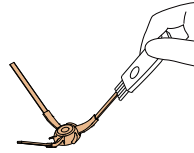

### 4) Clean casters wheel

- 1 Pry out the caster axle and pull out the caster body with a small screwdriver and other tools.
- 2 Clear the caster axle and pull out the caster body of any hair and dirt, then reinstall and compress them.

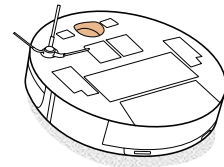
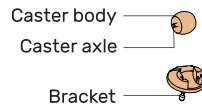

### 5) Clean wheels

- 1 Wipe and clean the wheels with a dry soft cloth.

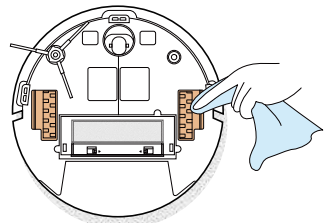

## 6) Clean sensors, charging contact pins and charging contacts

- 1 Wipe and clean the sensors with a soft dry cloth.

### ⚠ Note :

- There are sensitive electronic components inside the product. Please wipe them with a soft dry cloth when cleaning. Do not use wet rags to prevent damage caused by water.

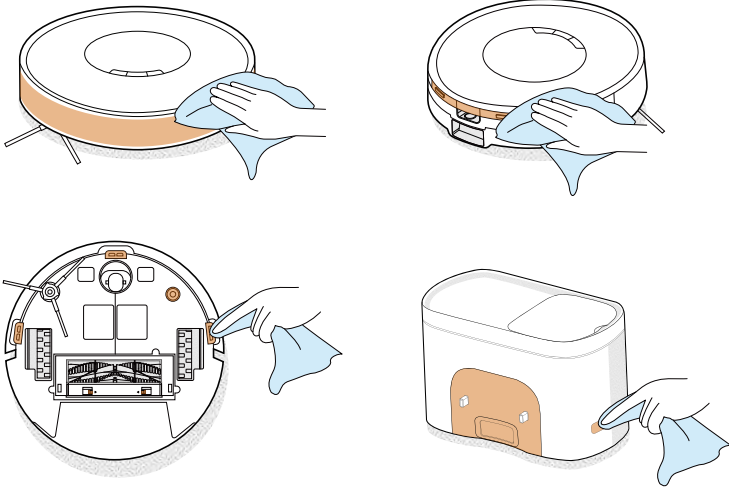

## 7) Replace the dust bag of auto-empty charging base, and clean the dust collection port and filter

When the dust bag is full, replace the dust bag according to the indicator light of the auto-empty charging base or the prompt of your mobile client. It is advisable to replace the dust bag once a month.

- 1 Open the dust bag cover of auto-empty charging base.
- 2 Pull up the handle of dust bag and take out the dust bag.

### ⚠ Note :

- When taking out the dust bag, the clip of dust bag handle will automatically close the dust bag to effectively prevent dust leakage.

- 3 Discard the used dust bag.
- 4 Wipe the filter in the bucket and the dust collection port on the outside with a soft dry cloth.
- 5 Install a new dust bag, push the clip along the guide rail.
- 6 Close the top cover of charging base.

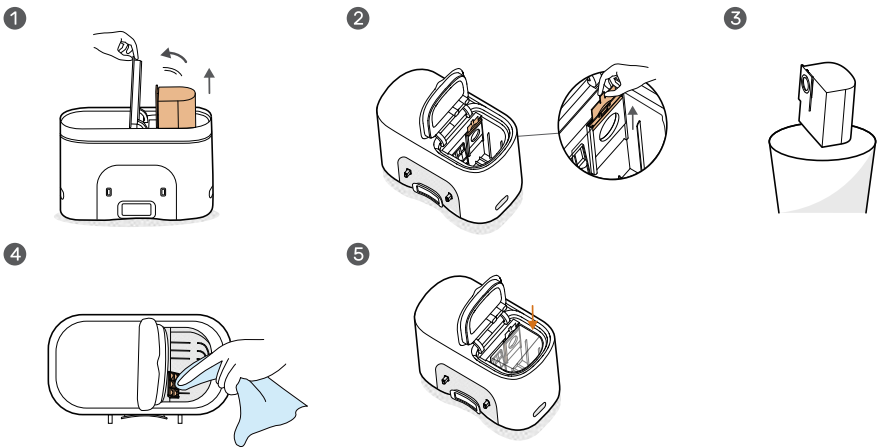

## 8) Clean the air duct

If the air duct is blocked, please clean it according to the following steps.

- 1 Put a soft cloth on the flat surface, and then lay the auto-empty charging base back and flat.

⚠ Note :

- Do not turn over the auto-empty charging base to avoid damaging the top decorative ring and dust bag cover.

- 2 Remove the air duct cover screws with a screwdriver and take out the air duct cover.
- 3 Check whether the air duct is blocked by dirt and clean it.
- 4 Install the air duct cover back with a screwdriver.

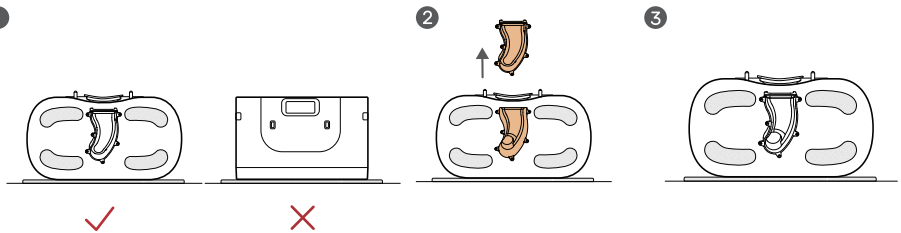

## 5.2 Troubleshooting

If an error occurs while the robot is working, the indicator light of the robot or the auto-empty charging base will light up in red in different states with corresponding prompt sound. Please solve it by the following table.

| Indicator light                   | Voice prompt   | Solution   |
|-----------------------------------|--|--|
| Robot -<br>Slowly<br>Flashing Red | <b>Error 1:</b> Front bumper stuck. Please clean and retry.                              | - The front bumper is stuck. Please tap repeatedly to remove any dirt. After confirmation, please relocate it to start.  |
|                                   | <b>Error 2:</b> Side brush stuck. Please clean and retry.                                | - The side brush may be entangled with trapped dirt. Please clean and retry.   |
|                                   | <b>Error 3:</b> Roller brush stuck. Please clean and retry.                              | - The roller brush may be entangled with trapped dirt. Please clean the roller brush and retry.  |
|                                   | <b>Error 4:</b> Wheel stuck. Please clean and retry.                                     | - The wheel may be entangled with trapped dirt. Please clean the wheel and retry.  |
|                                   | <b>Error 5:</b> Optical path sensor dirty. Please clean and retry.                       | - The optical path sensor may be stuck with dust. Please wipe it with a dry cloth and retry.   |
|                                   | <b>Error 6:</b> Filter blocked or wet. Please clean, dry and retry.                      | - The filter may be blocked or wet. Please clean it. If it is not dry, please dry it for at least 24 hours. If it cannot be solved, please replace the filter.   |
|                                   | <b>Error 7:</b> Wheel suspended. Please move it to near its original position and retry. | - The robot may be picked up or suspended, please move it to a new position close to the original position and retry.<br>- The robot is suspended in the air or the cliff sensor may be stuck with dirt or blocked. Please wipe the cliff sensor with a dry cloth and then move it to a nearby place to start. |
| Robot -<br>Solid Red              | <b>Error 9:</b> Strong magnetic field detected. Please relocate it to start.             | - When starting, the robot is too close to a magnetic boundary strip or strong magnetic field. Please put the robot on a new location to start.  |
|                                   | <b>Error 11:</b> Low Battery. The system is about to shut down. Please charge it.        | - The battery power is low (less than 5%) and it is not on the charging base. Please charge the robot at the charging base.  |

|   |   |  |
|---|---|--|
| Robot -<br>Solid Red                                | <b>Error 12:</b> Robot trapped. Please clear obstacles around.                          | - The robot may be stuck or trapped. Please clear obstacles around the robot.  |
|   | <b>Error 13:</b> Charging base blocked. Please clear it.                                | - The area around the charging base may be blocked by obstacles or dust. Please clean the area around and wipe the charging base location beacon area.   |
|   | <b>Error 14:</b> Charging error. Please wipe the charging contacts.                     | - Please wipe the charging contact pins of the robot and the charging contacts of the charging base with a dry cloth.  |
| Robot -<br>Alternately<br>Flashing Red<br>and White | <b>Error F1:</b> Side brush module fault. Please check and try restarting the system.   | - Please check whether side brush is entangled with dirt. Please remove, clean and reinstall the side brush, and then try to turn off and then turn on the system.<br>- If the fault persists, please contact our customer service.    |
|   | <b>Error F2:</b> Roller brush module fault. Please check and try restarting the system. | - Please check whether the roller brush is entangled with dirt. Please remove, clean and reinstall the roller brush then try to turn off and then turn on the system.<br>- If the fault persists, please contact our customer service. |
|   | <b>Error F3:</b> Vacuum fan module fault. Please check and try restarting the system.   | - Please check whether the dust box, filter or dust suction port is blocked by dirt. Please clear them, and then try to turn off and then turn on the system.<br>- If the fault persists, please contact our customer service.         |
|   | <b>Error F4:</b> Wheel module fault. Please check and try to restart the system.        | - Please check whether the wheel is entangled with dirt. Please clean it, and then try to turn off and then turn on the system.<br>- If the fault persists, please contact our customer service.                                       |

|  |   |  |
|--|---|--|
| <p>Robot -<br/><b>Alternately Flashing Red and White</b></p> | <p><b>Error F5:</b> Optical path sensor module fault. Please check and try restarting the system.</p>           | <ul style="list-style-type: none"> <li>- Please check whether the optical flow sensor is blocked or dirty, clean it, and then try to turn off and restart the system.</li> <li>- If the fault persists, please contact our customer service.</li> </ul>  |
|  | <p><b>Error F6:</b> Battery module fault. Please wait until the battery temperature is normal before using.</p> | <ul style="list-style-type: none"> <li>- The battery temperature is too high or too low. Please wait for the battery temperature to be normal before use.</li> <li>- If the fault persists, please contact our customer service.</li> </ul>  |
| <p>Charging base -<br/><b>Solid Red</b></p>                  | <p><b>Please check whether the dust bag is installed and close the cover properly.</b></p>                      | <ul style="list-style-type: none"> <li>- Please check whether the dust bag is missing, ensure that the dust bag is installed in place, and close the dust bag cover.</li> <li>- Please check the status of the dust bag cover to ensure that the dust bag cover is closed and sealed firmly.</li> </ul>                    |
| <p>Charging base -<br/><b>Slowly Flashing Red</b></p>        | <p><b>Long time using dust bag, please replace the dust bag.</b></p>  | <ul style="list-style-type: none"> <li>- Please check the status of the dust bag and replace the dust bag in time. If the dust bag is new, please take out the dust bag and reinstall.</li> </ul>  |
| <p>Charging base -<br/><b>Rapidly Flashing Red</b></p>       | <p><b>Air duct blocked. Please clean it.</b></p>  | <ul style="list-style-type: none"> <li>- Please check whether the auto-empty dirt port of the robot and the auto-empty dirt port of the charging base are blocked. If not, start emptying detection.</li> <li>- If the above cannot be solved, refer to the chapter "Clean the air duct" to clean the air duct.</li> </ul> |
| <p>-</p>   | <p><b>Frequent operation. Please try again later.</b></p>   | <ul style="list-style-type: none"> <li>- In order to prevent the component temperature from being too high, please wait for a period of time and try again.</li> </ul>   |



### 5.3 FAQs



| Problem type               | Solution   |
|----------------------------|--|
| Unable to turn on.         | <ol style="list-style-type: none"> <li>1) Low battery power. Please make sure that the charging base is connected to the power supply, then place the robot on the charging base and align it with the charging contacts, and the device will start automatically.</li> <li>2) If it still cannot be started, please try to force restart system. When robot is not charging, press and hold the power button for 10 seconds to force turn off, and then press and hold the power button for 3 seconds to power on.</li> </ol>   |
| Unable to charge.          | <ol style="list-style-type: none"> <li>1) Please remove the robot from charging base and check whether the indicator light of the charging base is on. If not, please make sure that the power cable and charging base's power port have been connected tightly, and the plug and the power socket have been plugged in. (If the light is not on, please contact our customer service.)</li> <li>2) If the indicator light of the charging base is on, connect the turn-on robot to the charging base and ensure that the charging contact pins of the robot is aligned with the charging base charging contacts. Check whether the indicator light of the robot changes to pulsing white.</li> <li>3) If the indicator light of the charging base is on and the robot is turned on, but the robot cannot be charged, please refer to "clean sensors, charging contact pins and charging base contacts" and then try the above two steps again. (If the problem persists, please contact our customer service.)</li> </ol> |
| Unable to start.           | <ol style="list-style-type: none"> <li>1) Make sure the robot is connected to the power supply.</li> <li>2) Make sure the robot is fully charged.</li> <li>3) Press and hold the power button for 3 seconds to turn on the robot.</li> </ol>   |
| Unable to recharge.        | <ol style="list-style-type: none"> <li>1) Please remove any obstacles near the charging base and place the charging base in an open area. Please ensure that no objects are placed within 1.5m in front of the charging base and 0.5m from both sides.</li> <li>2) Please wipe the infrared obstacle avoidance sensor, recharge sensor, charging base location beacon area, charging contact pins and charging contacts with a soft dry cloth.</li> <li>3) Please put the robot near the charging base and try again.</li> </ol>   |
| It stops working suddenly. | <ol style="list-style-type: none"> <li>1) Check whether the robot is trapped or stuck by obstacles.</li> <li>2) Check whether the battery power is too low.</li> <li>3) Check whether the robot has a red light or fault prompt. Please refer to the chapter "troubleshooting".</li> <li>4) If the problem persists, please force restart system, press and hold the power button for 10 seconds to force turn off, and then press the power button for 3 seconds to turn on.</li> </ol>   |

|   |   |
|---|---|
| Abnormal behavior.  | <ol style="list-style-type: none"> <li>1) Please check whether there is corresponding error prompt. Please refer to the chapter "troubleshooting".</li> <li>2) Please wipe the sensor with a soft cloth, please refer to the chapter "routine maintenance".</li> <li>3) Please restart the robot.</li> </ol>  |
| The robot vacuum cleaner suddenly generates a loud noise. | <ol style="list-style-type: none"> <li>1) Please adjust the suction level or turn off auto-boost to see if this setting leads to high noise.</li> <li>2) Please check whether the roller brush, filter, dust box, dust suction port, wheel and caster wheel are blocked by dirt.</li> <li>3) Please ensure that the filter, the roller brush and the roller brush cover are installed in place.</li> </ol>  |
| The cleaning performance decreases or ash falls.          | <ol style="list-style-type: none"> <li>1) Please clean the dust box.</li> <li>2) Please clean or replace the filter.</li> <li>3) Please clean the roller brush.</li> </ol> <p>Refer to the chapter "routine maintenance" for specific methods.</p>  |
| The roller brush does not rotate.                         | <ol style="list-style-type: none"> <li>1) Please clean the roller brush and both ends of the roller brush, and check for cleaning hair and dirt.</li> <li>2) Check whether the roller brush and roller cover are installed correctly.</li> </ol>  |
| Unable to connect Wi-Fi.                                  | <ol style="list-style-type: none"> <li>1) Please ensure that the robot is in a good Wi-Fi signal coverage area.</li> <li>2) Please download the latest mobile client, reset Wi-Fi and try to connect again.</li> <li>3) Please check whether the Wi-Fi password is entered incorrectly or has special characters.</li> <li>4) Please check whether the router is using 5G band network or 2.4G/5G Mixed band. This robot vacuum cleaner only supports 2.4G band.</li> </ol>   |
| Scheduled cleaning is not performed.                      | <ol style="list-style-type: none"> <li>1) Please check whether the battery power is <math>\geq 12\%</math>, and scheduled cleaning can be started only when the power is <math>\geq 12\%</math>.</li> <li>2) Please check whether the scheduled cleaning cycle is set accurately.</li> <li>3) Please check whether scheduled cleaning is set successfully. Try to schedule it on your mobile client again. When scheduled cleaning is set successfully, the robot vacuum cleaner will sound a prompt tone.</li> </ol> |

If the fault cannot be eliminated according to the above methods, please contact our customer service. As your problem is our great concern, we will try our best to help you solve it.

## 6. Declaration

### Basic Parameters

| <b>Robot vacuum cleaner</b>     |  |
|---------------------------------|--|
| Product name                    | Robot vacuum cleaner   |
| Model No.                       | S102   |
| Rated voltage                   | 14.4V   |
| Input power supply              | 20V  1A |
| Charging time                   | < 6 hours  |
| Wireless connection             | Wi-Fi IEEE 802.11b/g/n 2.4GHz  |
| <b>Auto-empty charging base</b> |  |
| Product name                    | Auto-empty charging base   |
| Model                           | SD01   |
| Rated input                     | 120VAC   |
| Rated output                    | 20V  1A |
| Rated frequency                 | 60Hz   |
| Power                           | 850W   |

### Trademark Notice

- Apple, the Apple logo, and iPhone are trademarks of Apple Inc., registered in the U.S. and other countries. App Store is a service mark of Apple Inc., registered in the U.S. and other countries.
- Amazon, Alexa, and all related logos are trademarks of Amazon.com, Inc. or its affiliates.
- Google, Google Play, the Google Play logo, and Android are trademarks of Google LLC.

## Energy saving and battery

### Holiday energy saving mode

- On the charging base, press and hold the recharge button for 10 seconds until you hear the prompt tone. At this time, the holiday energy saving mode will be activated.
- In the holiday energy-saving mode, network, remote control and scheduling will be turned off, and the robot will enter the low-power mode to save energy.
- Only when the robot is removed from the charging base or any button is pressed can the function be ended.
- And the auto-empty charging base also needs to be unplugged to power off for ending the holiday energy saving mode on the auto-empty charging base.

### Remove the battery (for disposal)

- This is applicable when discarding this product and is not a daily operation instruction.
- The chemical substances contained in the built-in lithium-ion battery of this product may pollute the environment. Please remove it before scrapping and hand it over to a professional battery recycling bin for centralized treatment.
  1. Let the robot run to a low power state that cannot be cleaned without touching the charging base.
  2. Press and hold the power button for 3 seconds to turn off the robot.
  3. Remove the screws of the battery compartment of the robot with a screwdriver and take out the cover of the battery compartment.
  4. Press the snap down to pull out the connector plug and take out the battery.
- When removing the battery, make sure that the power is exhausted as far as possible and operate safely with power cut off.
- Please remove the whole battery pack together. Do not damage the shell of the battery pack to avoid short circuit or leakage of dangerous substances.
- If the battery has exudate and is accidentally touched, please wash it with plenty of water and get medical attention in time.



# Customer Service

## Customer service

If you have any questions and dissatisfaction in using the product, you can get more technical support by contacting us in the following ways. As your problem is our great concern, we will try our best to help you solve it.

### Sincere care, always for you

- Customer service, warranty, tutorial video, FAQs
- Our latest events and news, more details

 [www.verefalife.com](http://www.verefalife.com)

 [support@verefalife.com](mailto:support@verefalife.com)

## Warranty

This product is restricted to local selling, and the customer service and warranty regulations are applicable only to local customers. We provide warranty in accordance with the local warranty regulations. Any difference between the following warranty contents and local laws or regulations is subject to the construction or interpretation in local laws or regulations.

| Type   | Warranty   | Warranty period |
|--|--|-----------------|
| Robot  | Robot (excluding its battery, accessories and consumables) | 1 year          |
| Parts  | Charging base, power cable, remote control                 | 1 year          |
| Battery  | Robot battery  | 1 year          |
| Note : Filter, roller brush, roller brush cover, side brush and dust bag are consumables. We provide no warranty for the accompanying consumables. |  |                 |

None of the following circumstances is covered by the warranty. However, paid repair is available for such circumstances:

1. The user fails to operate the product in accordance with the instructions and causes damage due to improper storage;
2. The free warranty for the robot and its parts have expired;
3. It is damaged during disassembly by maintenance workers not authorized by us;
4. Unable to provide a valid purchase voucher number;
5. The model specified in the warranty card is inconsistent with the S/N of the product to be repaired or the model is altered;
6. Damage caused by irresistible factors such as natural disasters;
7. Product failure or damage caused by accidental factors or human factors (including operation error, liquid inlet, improper plugging, scratching, handling, collision, input of inappropriate voltage, etc.).

## Product Warranty Card

|                          |   |
|--------------------------|---|
| User name                |   |
| Mailing address          |   |
| Email address            |   |
| Phone number             |   |
| Model No.                | S102  |
| Product S/N              |   |
| Product purchase date    |   |
| Product purchase channel | <input type="checkbox"/> Amazon <input type="checkbox"/> eBay <input type="checkbox"/> Official website<br><input type="checkbox"/> Taobao <input type="checkbox"/> Jingdong <input type="checkbox"/> Others, _____ |

## Repair record

|   | Repair date | Repair location | Repair worker | Fault description | Replaced accessories |
|---|-------------|-----------------|---------------|-------------------|----------------------|
| 1 |             |                 |               |                   |                      |
| 2 |             |                 |               |                   |                      |
| 3 |             |                 |               |                   |                      |
| 4 |             |                 |               |                   |                      |
| 5 |             |                 |               |                   |                      |





**Sincere care, always for you**

Customer service, warranty, tutorial video, FAQs  
Our latest events and news, more details

---

 [www.verefalife.com](http://www.verefalife.com)

 [support@verefalife.com](mailto:support@verefalife.com)

Room 2-077,2-078,2nd Floor,No.2 Building,No.17 Caohejing  
Road,Haining Economic Development Zone,Haining City,  
Jiaxing City,Zhejiang Province

S1021100  
123.00140.004S

00