



EV Portable Charger

Model : HS1 - User Manual

Before operating this product, please read the enclosed Operating Instructions completely

▲ IMPORTANT SAFETY INSTRUCTIONS

WARNING :

When using electric products, basic precautions should always be followed, including the following. This manual contains important instructions for Models EV-B11-US that shall be followed during installation, operation and maintenance of the unit.

When the instructions are exactly the same for all models, specific model numbers are not required to be specified:

- a) Read all the instructions before using this product.
- b) This device should be supervised when used around children.
- c) Do not put fingers into the electric vehicle connector.
- d) Do not use this product if the flexible power cord or EV cable is frayed, has broken insulation, or any other signs of damage.
- e) Do not use this product if the enclosure or the EV connector is broken, cracked, open, or shows any other indication of damage.
- f) Caution - To reduce the risk of fire, connect only to a circuit provided with 40 amperes maximum branch circuit overcurrent protection in accordance with the NEC.
- g) This product must be grounded. If it should malfunction or break down, grounding provides a path of least resistance for electric current to reduce the risk of electric shock. This product is equipped with a cord having an equipment grounding conductor and a grounding plug. The plug must be plugged into an appropriate outlet that is properly installed and grounded in accordance with all local codes and Ordinances.
- h) WARNING - Improper connection of the equipment-grounding conductor is able to result in a risk of electric shock. Check with a qualified electrician or serviceman if you are in doubt as to whether the product is properly grounded. Do not modify the plug provided with the product - if it will not fit the outlet, have a proper outlet installed by a qualified electrician.

SAVE THESE INSTRUCTIONS

▲ AC SINGLE-PHASE PORTABLE EV CHARGER

Portable and Convenient

Simple and portable.

Charge your EV wherever and whenever.

Plug and Play

Easy operation, plug and play.

Charging EV just like charging your mobile phone.



Safe and Reliable

Current leakage protection to ensure safety. Over temperature protection to secure reliability.

▲ SPECIFICATIONS

Product Models		AC EV CHARGER SERIES	
		HS1	
AC Nominal Input	Voltage	120V (±10%) Requires its own 120V adapter	240V (±10%)
	Frequency	60Hz	
AC Nominal Output	Voltage	120V(±10%)	240V (±10%)
	Current	16/13/10/8A (4 gears adjustment)	32/24/16/10A (4 gears adjustment)
	Power	3.8KW (MAX)	7.6KW (MAX)
Feature Design	Indicator	1 indicators	
	Display screen	1.5 inch OLED display	
	Material of enclosure	PC+ABS	
	Charging Outlet	SAE J1772, (Type 1)	
Environmental	Operating Temperature	-30 ~ +50 °C	
	Storage Temperature	-40 C ~80 C	
	Working Humidity	5%~95% Without condensation	
	Working Altitude	<2000m	
Index	Protection Grade	NEMA Type 4 (control box)	
	Application Site	Indoor / Outdoor	
	Cooling Method	Natural cooling	
Security Protection	Multiple Protection	Over/Under voltage protection, Over temperature protection, Over current protection, Grounding protection, Current leakage protection (CCID20)	
	MTBF	100,000 hours	
	Overall dimension	245*105*62mm (H*W*D)	

▲ PRODUCT FEATURES

Adjust current

Adjust current to meet different charging needs.

240V 32A: 32/24/16/10A 4 gear current adjustment.

120V (Requires its own 120V adapter) 16A :16/13/10/8A 4 gear current adjustment.

Scheduled Charging

1-12H scheduled charging.

Friendly Interface

Intuitive HMI with LED indicators.

With LED screen display more intuitive.

Robust and Durable

Anti-corrosion and weather proof.

Type 4 protection grade for outdoor use stably.

Product overview

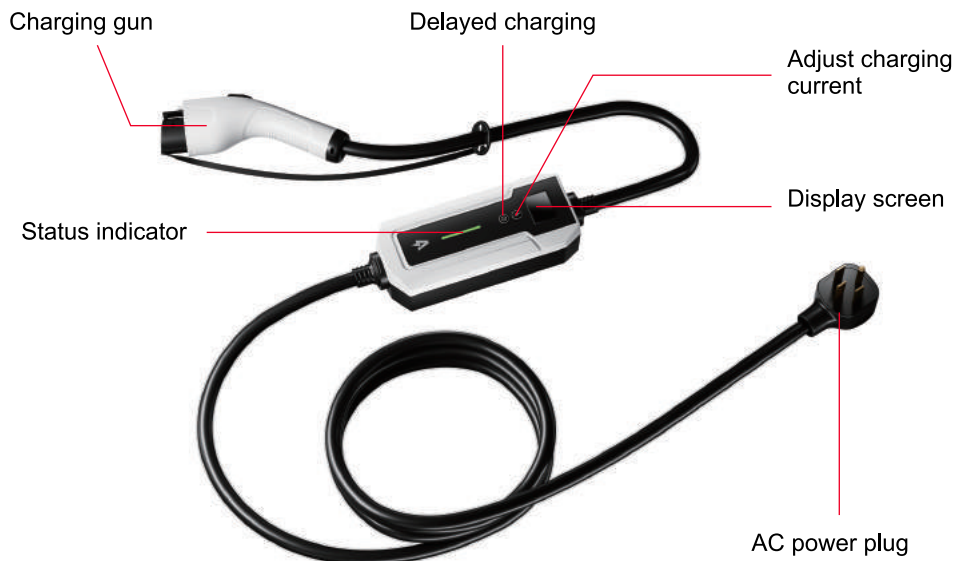

▲ INSTALLATION INSTRUCTIONS

1. List of Parts

General purpose accessories		
Product specification	Ac pile instruction manual	1 PCS
Storage bag	Portable hard case travel bag	1 PCS
Wall mount installation		
Wall mount	Wall mounted fasteners	1 PCS
Expansion screw	M8*60 expansion screw	2 PCS
Charging cable hook	Plastic hook	1 PCS
Expansion screw	M6*40 expansion screw	3 PCS

2. The installation method of wall hanging

a. Take out the provided wall mounting fasteners and carefully check the installation dimensions of the screw holes.

b. Select the installation location of the device. The lowest position of the equipment is a wall mounted fastener 1200 mm above the ground.

c. Drill 2 holes with a diameter of 8mm according to the location of the fixed screw holes of Wall mounted fasteners, and tap in the expansion rubber plugs. Fix the mounting plate with nuts to fix the chassis.

Dimension unit is mm.

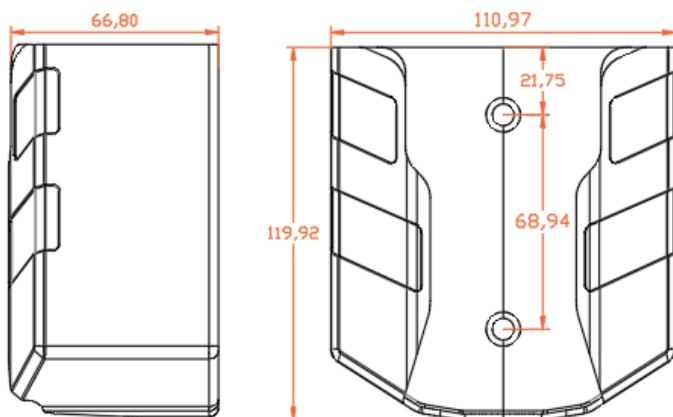

d. For charging gun/cable storage bracket, please refer to the following installation

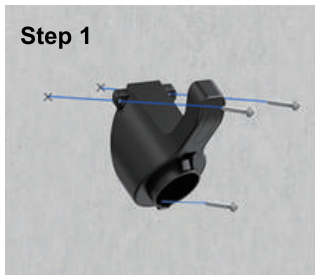

Drawing of fixing holes



Drilling with tools



Insert the expansion tube and screw it in

▲ MOBILE PHONE APP CHARGING OPERATING INSTRUCTIONS

1. APP download and binding use

a. To download the smart APP, enter the following address in the mobile browser: <https://developer.tuya.com/cn/docs/iot/tuya-smart-app-smart-life-app-advantages?id=K989rqa-49rluq>

Click the website and follow the prompts to install.



b. Qr code download:

Open the mobile browser or other social software, scan the QR code, and follow the APP according to the prompts.

2. Binding and Using Devices

Step1:

Open the installed APP, click Agree privacy Statement, you can register with your mobile phone number, social software binding registration, and log in to the APP after a successful registration. Open the Location, Bluetooth, and WIFI of the mobile phone. If the charging device is in standby state, the APP will automatically search for the charging device and the device name will be displayed.

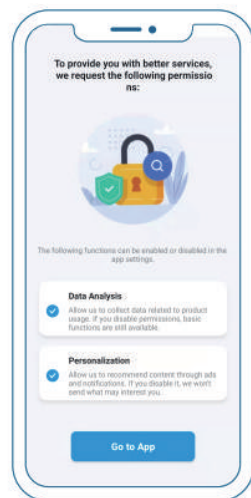

Step 2:

Click "Add device", enter the WIFI pairing interface, automatically identify the WIFI name of the phone. Click Next, and the device will be automatically bound. After the binding is successful, a message will be displayed indicating that the device has been successfully added. Finally, click the icon of "Finish" and wait about 5 seconds for the device to be bound.

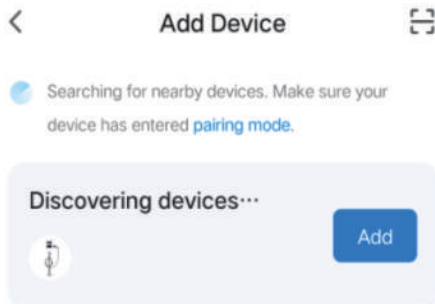

You can also click "+" in the upper right corner of the APP to manually add the device, select the category of "Energy" in the left column, pull up the device type, find the device "Car charging pile (Bluetooth + WIFI)", Click to enter, then follow the prompts and click on "Confirm if the indicator light is flashing", then click on "Quick flashing" again.

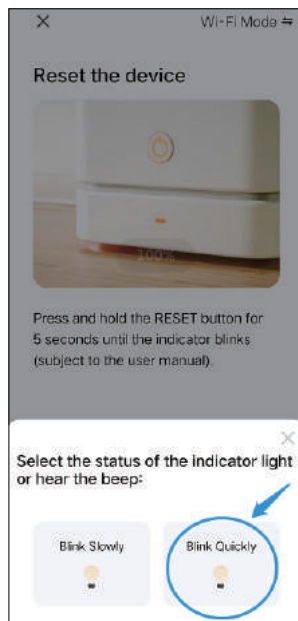
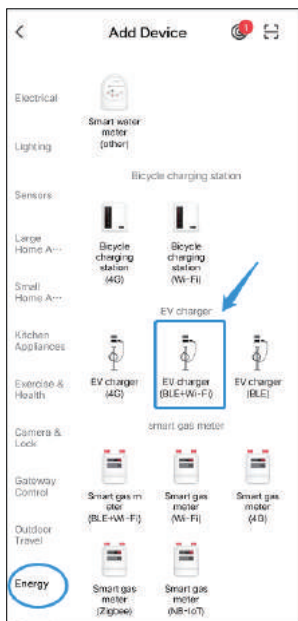

Step 3 :

Enter the WIFI password (WIFI password connected to the mobile phone) and click Next to match the password, and always set the bound device as prompted.

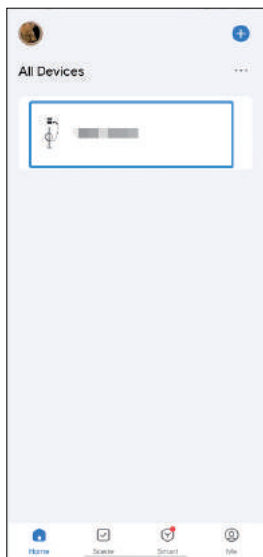
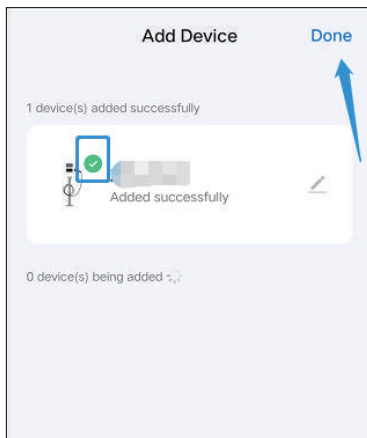
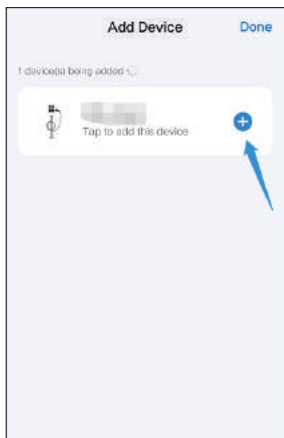
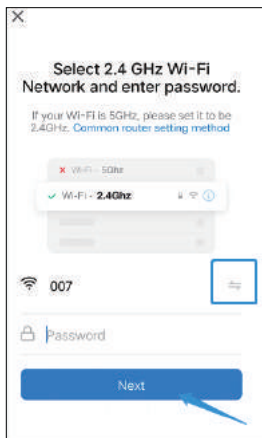

Step 4 :

After binding the device, charge it according to the APP interface. In addition, the application can also support the functions of "adjusting current" and "delayed charging".

▲ APP FUNCTION

Charging mode function :

Click “Charging mode” to switch between real-time charging and delayed charging mode (appointment charging mode) , You can set an appointment to delay charging for a period of 1-12 hours

Adjust charging current :
Click “Setting”into“Charging current” ,Slide up and down to set charging current .

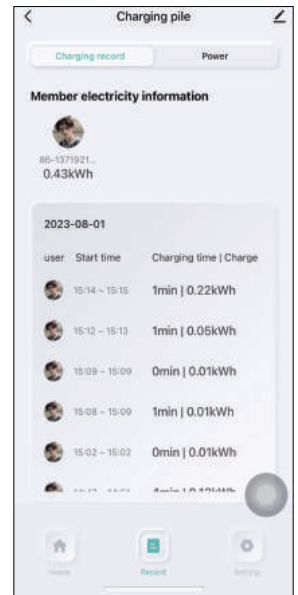
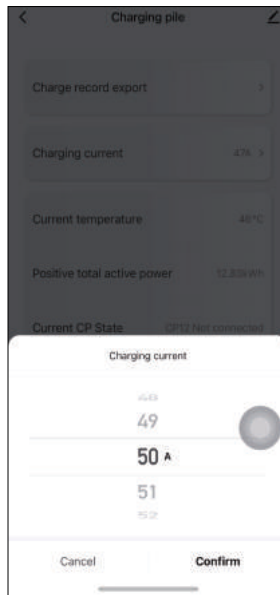
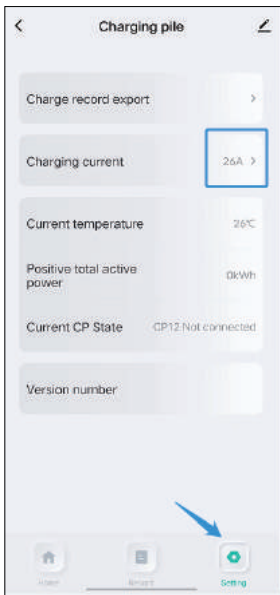
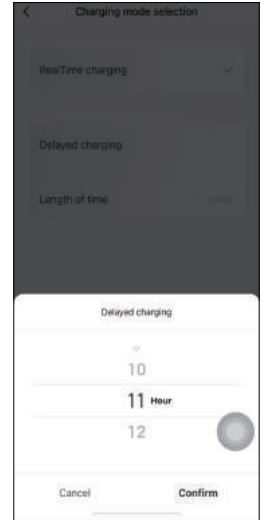
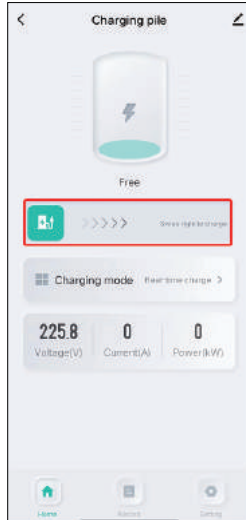

Record of charging :

Click “Charge record export ”,you can check the charging record and Power record .

▲ CHARGING INSTRUCTIONS

Step 1.

After the device is powered on, it enters the standby state. The device display interface is shown below:

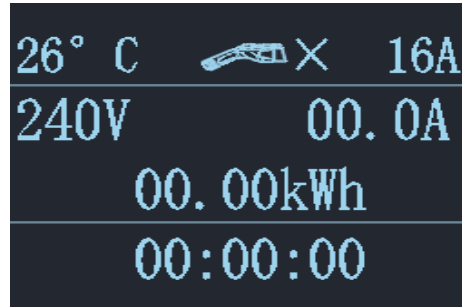

Step 2.

Adjust the charging current: click the button “A” to adjust the charging gear: 32A-24A-16A-10A-32A Cycle the current in this order. When the user connects the 120V power supply with the self-configured adapter, the adjustable current will be automatically recognized as: 16A-13A-10A-8A-16A Cycle Settable, After switching the usage current, plug in the gun head to charge.◦

Note:

- 1) The current can only be selected prior to inserting the charging connector
- 2) Please ensure that the selected current is within the carrying capacity of your electrical circuit.



Step 3.

Appointment charging: Click to increase the reservation time. You can choose between 1 and 12H. After the appointment time, it will automatically enter the charging state.

Note:

The appointment charging schedule can only be configured prior to inserting the charging connector.

Step 4.

After inserting the charging gun head into the vehicle charging port, the charging interface is shown below:

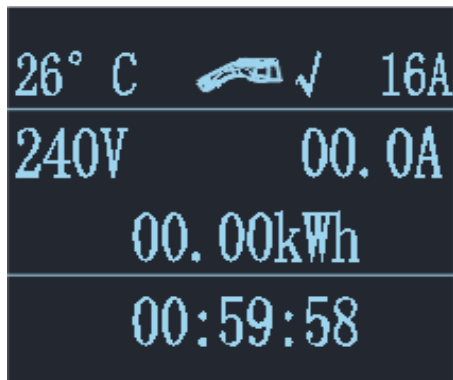
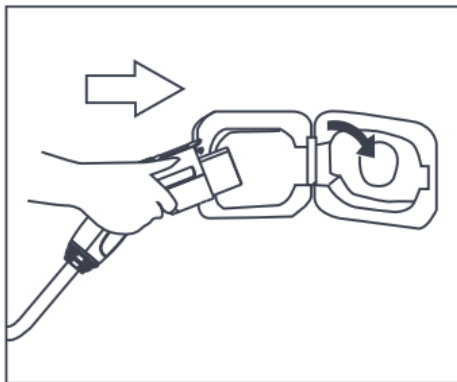

Step 5.

After charging is complete, unplug the charging gun and place the dust cover onto the charging connector.

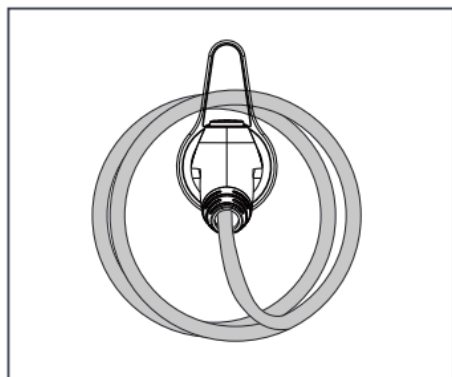
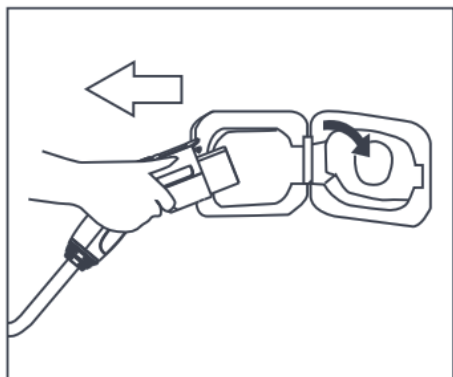

▲ STATUS INDICATOR

Charging indicator LED indicator status table	
Three color indicators status	blue light:standby
	green light:charging
	yellow light:failure
Standby	steady blue light
Connected	steady green light
Charging	green light flashing
CP fault	steady yellow light
Over voltage or under voltage	the yellow light blinks once every 1S
No ground wire	the yellow light blinks once every 2S
Over current	the yellow light blinks once every 4S
Electric leakage	the blue and yellow light blink once every 1S
Over temperature	the blue and yellow light blink once every 2S

▲ COMMON PROBLEMS AND SOLUTIONS

Problems	Cause	Solution
The Display is black (LED indicator is off)	The AC inlet switch is not closed, and the AC inlet switch is tripping.	Close the AC incoming wire switch again. If it trips all the time, please check whether the wiring of the equipment is correct and the L or N wire is connected to the PE terminal.
Controller Boot Failure	The gun is not inserted properly; During the charging process, someone pressed a button on the charging handle.	Put the gun back in place; Strengthen supervision after normal charging to prevent someone from pressing the handle button during charging
End lock gun	The WIFI signal network is unstable, and unlocking failed. Vehicle communication problem.	turn off the car starting key, turn off the engine and lock the car, and then restart the car; If the problem cannot be solved, please contact the car dealers!
Symptom Possible causes	AC input voltage too high	<ol style="list-style-type: none"> 1. If the voltage exceeds 265V AC for a short time, wait for the power grid to restore itself to the normal voltage range. 2. Check the background monitoring data and analyze. If the voltage in this area is overvoltage for a long time, adjust the input overvoltage protection point to 265V AC by configuring software.
AC undervoltage	AC input voltage too low	Check the background monitoring data and analyze. If the voltage in this area is chronically undervoltage (175V AC), the protection point of input undervoltage can be adjusted to 90 Vac at least by configuring software.
AC overcurrent	Excessive AC input current	<ol style="list-style-type: none"> 1. Immediately turn off the leakage/overcurrent protection circuit breaker of the power distribution box. 2. Check whether there is low impedance or short circuit between the output line of AC pile. 3. After the fault is rectified, power on the device again. If the fault persists
Overtemperature	The temperature in the AC pile is too high	Check the ac pile installation environment. Check whether there are other heating devices nearby. Ensure that the ambient temperature is below 50 ° C.
Current cannot reach the set or defined value	<ol style="list-style-type: none"> 1. Using an adapter 2. Vehicle is set for charging current 3. The vehicle's power is relatively full (more than 90%) 4. Setting of the current level of the charging pile 	<ol style="list-style-type: none"> 1.If the adapter is used, please check whether the rated working current of the adapter is matched; 2. if the vehicle can set the charging current, please check whether the vehicle setting current gear is matched; 3.If the vehicle's power is relatively full (more than 90%), the vehicle may reduce the charging current, which is normal; 4.Check whether the current gear of the charging pile is set correctly ,you can check directly check the current gear in the upper right corner of the screen

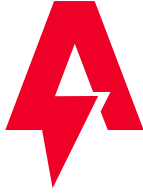

FCC statement:

This equipment has been tested and found to comply with the limits for a Class B digital device, pursuant to part 15 of the FCC Rules. These limits are designed to provide reasonable protection against harmful interference in a residential installation. This equipment generates, uses and can radiate radio frequency energy and, if not installed and used in accordance with the instructions, may cause harmful interference to radio communications. However, there is no guarantee that interference will not occur in a particular installation. If this equipment does cause harmful interference to radio or television reception, which can be determined by turning the equipment off and on, the user is encouraged to try to correct the interference by one or more of the following measures:

- Reorient or relocate the receiving antenna.
- Increase the separation between the equipment and receiver.
- Connect the equipment into an outlet on a circuit different from that to which the receiver is connected.
- Consult the dealer or an experienced radio/TV technician for help.

This device complies with part 15 of the FCC Rules. Operation is subject to the following two conditions: (1) This device may not cause harmful interference, and (2) this device must accept any interference received, including interference that may cause undesired operation.

EU importer

VISHTEC Ltd

Address: 3 rd floor office 5, Plovdiv 2 Liuben Karavelov bul, 4002 Bulgaria

Email: compliance@vish-tec.com

UK Importer

VISHTEC UK Co.,Ltd

Address: 275 ISLINGTON SUITE 1405 NEW NORTH ROAD LONDON ENGLAND N1 7AA

Email: Vincent.feng@vish-tec.com



MADE IN CHINA