

Network Video Recorders

Quick Guide

Manual Version: V1.00

Thank you for purchasing our product. If there are any questions, or requests, please do not hesitate to contact the dealer.

Copyright

Copyright 2016 Zhejiang Uniview Technologies Co., Ltd. All rights reserved. No part of this manual may be copied, reproduced, translated, or distributed in any form or by any means without prior consent in writing from our company.

Trademark Acknowledgement

 and other Uniview's trademarks and logos are the property of Zhejiang Uniview Technologies Co., Ltd. Other trademarks, company names and product names contained in this manual are the property of their respective owners.

Disclaimer



CAUTION!

The default password is used for your first login. To ensure account security, please change the password after your first login. You are recommended to set a strong password (no less than eight characters).

- To the maximum extent permitted by applicable law, the product described, with its hardware, software, firmware and documents, is provided on an "as is" basis.
- Best effort has been made to verify the integrity and correctness of the contents in this manual, but no statement, information, or recommendation in this manual shall constitute formal guarantee of any kind, expressed or implied. We shall not be held responsible for any technical or typographical errors in this manual. The

contents of this manual are subject to change without prior notice. Update will be added to the new version of this manual.

- Use of this manual and the product and the subsequent result shall be entirely on the user's own responsibility. In no event shall we be reliable to you for any special, consequential, incidental, or indirect damages, including, among others, damages for loss of business profits, business interruption, or loss of data or documentation, or product malfunction or information leakage caused by cyber attack, hacking or virus in connection with the use of this product.
- Video and audio surveillance can be regulated by laws that vary from country to country. Check the law in your local region before using this product for surveillance purposes. We shall not be held responsible for any consequences resulting from illegal operations of the device.
- The illustrations in this manual are for reference only and may vary depending on the version or model. The screenshots in this manual may have been customized to meet specific requirements and user preferences. As a result, some of the examples and functions featured may differ from those displayed on your monitor.
- This manual is a guide for multiple product models and so it is not intended for any specific product.
- Due to uncertainties such as physical environment, discrepancy may exist between the actual values and reference values provided in this manual. The ultimate right to interpretation resides in our company.



Environmental Protection

This product has been designed to comply with the requirements on environmental protection. For the proper storage, use and disposal of this product, national laws and regulations must be observed.



Safety and Compliance Information

Safety Symbols

The symbols in the following table may be found on installation-related equipment. Be aware of the situations indicated and take necessary safety precautions during equipment installation and maintenance.

Symbol	Description
	Generic alarm symbol: To suggest a general safety concern.
	ESD protection symbol: To suggest electrostatic-sensitive equipment.
	Electric shock symbol: To suggest a danger of high voltage.

The symbols in the following table may be found in this manual. Carefully follow the instructions indicated by the symbols to avoid hazardous situations and use the product properly.

Symbol	Description
 WARNING!	Indicates a hazardous situation which, if not avoided, could result in bodily injury or death.
 CAUTION!	Indicates a situation which, if not avoided, could result in damage, data loss or malfunction to product.
 NOTE!	Indicates useful or supplemental information about the use of product.

Safety Information

Installation and removal of the unit and its accessories must be carried out by qualified personnel. Please read all of the safety instructions below before installation and operation.

- This device is a class A product and may cause radio interference. Take measures if necessary.
- While shipping, the device should be packed in its original packing.
- Verify that installation is correct. Incorrect cable connection may cause personal injury or device damage.
- The installation must be made by qualified personnel and should conform to all the local codes.
- If the product does not work properly, please contact your dealer. Never attempt to disassemble the device yourself. We shall not assume any responsibility for problems caused by unauthorized repair or maintenance.
- Ensure a proper operating environment, including temperature, humidity, ventilation and power supply. Make sure the device is properly grounded and the lightning protection meets requirements. Keep the device from moisture, dust, strong electromagnetic radiation and vibration.
- Power down the device before connecting and disconnecting accessories and peripherals.
- Protect the power cable from being stepped on or pressed, particularly at the plug, receptacle, and the part leading out of the device.
- Strictly follow the procedure to shut down the device. Sudden power failures can cause disk damage and functional abnormalities. In an environment where power supply is frequently interrupted, use an Uninterrupted Power Supply (UPS).
- Improper use or replacement of the battery may result in hazard of explosion. Use the manufacturer recommended battery.
- Take necessary measures to ensure data security and protect the device from network attack and hacking (when connected to Internet). Possible risks and consequences are at user's sole discretion.



WARNING!



- Never look at the transmit laser while the power is on. Never look directly at the fiber ports and the fiber cable ends when they are powered on.
 - Use of controls or adjustments to the performance or procedures other than those specified herein may result in hazardous laser emissions.
-

Regulatory Compliance

FCC Part 15

This equipment has been tested and found to comply with the limits for digital device, pursuant to part 15 of the FCC Rules. These limits are designed to provide reasonable protection against harmful interference when the equipment is operated in a commercial environment. This equipment generates, uses, and can radiate radio frequency energy and, if not installed and used in accordance with the instruction manual, may cause harmful interference to radio communications. Operation of this equipment in a residential area is likely to cause harmful interference in which case the user will be required to correct the interference at his own expense.

This product complies with Part 15 of the FCC Rules. Operation is subject to the following two conditions:

1. This device may not cause harmful interference.
2. This device must accept any interference received, including interference that may cause undesired operation.

LVD/EMC Directive



This product complies with the European Low Voltage Directive 2006/95/EC and EMC Directive 2004/108/EC.

WEEE Directive–2002/96/EC



The product this manual refers to is covered by the Waste Electrical & Electronic Equipment (WEEE) Directive and must be disposed of in a responsible manner.

Contents

1 Appearance	1
Front Panel and LED Indicators	1
Rear Panel and Interfaces	2
2 Installation and Connection	3
Installing Hard Disks	4
Replacing a Hard Disk.....	5
Installing a Power Module (Optional)	6
Installing a Decoding Card (Optional)	7
Mounting the Device	8
Connecting the Device	9
3 Startup and Shutdown	9
Before Startup.....	9
Startup	9
Shutdown	10
4 Setup	10
Adding an IP Device	10
Preview	11
Preview Window Toolbar	11
Status Icons in Preview Window	12
Shortcut Menu.....	12
Scheduled Recording	13
Playback	14
Login to the Web Interface	14
5 FAQs	15

1 Appearance

The figures in this manual are only for illustration purpose and may be different from the actual device.

Front Panel and LED Indicators

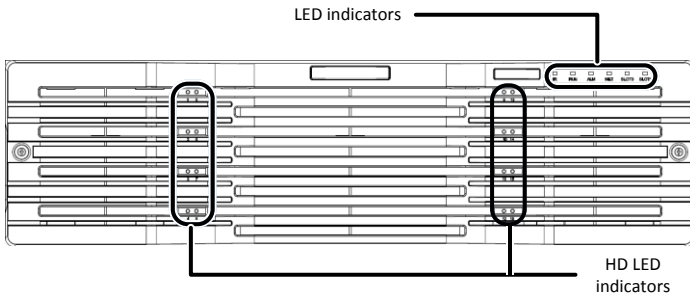

LED	Description
RUN (Operation)	<ul style="list-style-type: none">• Steady on: The NVR is operating properly.• Blinks: The NVR is starting up.• Off: The NVR is shut down.
ALM (Alarm)	<ul style="list-style-type: none">• Steady on: A device alarm has occurred.• Off: No alarm.
NET (Network)	<ul style="list-style-type: none">• Steady on: The NVR has network connection.• Off: No network connection.
SLOT (Slot card)	<ul style="list-style-type: none">• Steady on: The card is installed.• Off: No card.
HD (Hard disk)	<ul style="list-style-type: none">• Steady green: The hard disk is operating properly without reading or writing data.• Blinks green: The hard disk is operating properly and it is reading or writing data.• Steady yellow: The hard disk is in abnormal status.• Blinks yellow: The disk array is being rebuilt.• Off: No disk; or the system is shut down.

LED	Description
LINK (Connection)	<p>Located next to the miniSAS interfaces on the rear panel.</p> <ul style="list-style-type: none"> Steady on: Connected to a disk enclosure. Off: No disk enclosure is connected. Blinks: The NVR is communicating with the disk enclosure.

Rear Panel and Interfaces

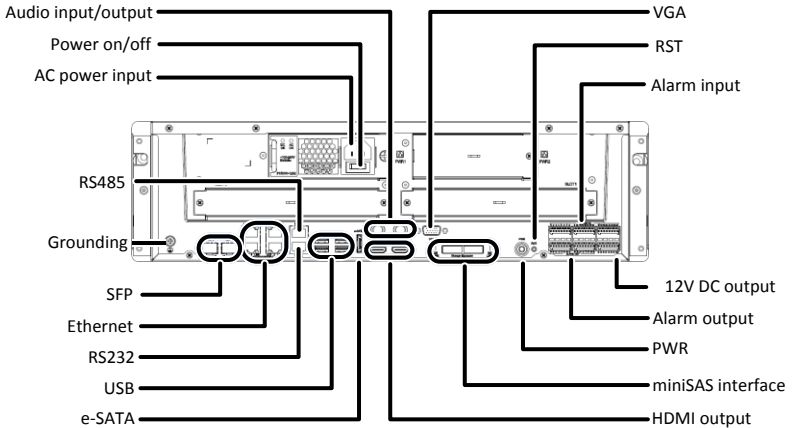

Interface	Description
Audio input/output	Connect to audio input/output devices.
Power on/off	Turn on or off the power.
AC power input	Connects to 100V-240V AC power. Note: The standard delivery includes one power module. Users may choose to purchase dual power modules as needed.
RS485	Connects to RS485-compliant devices such as a keyboard.
Grounding	Connects to ground.

Interface	Description
SFP	2×1000M optical interfaces, connect to fiber optic cables.
Ethernet	4×10M/100M/1000M auto-negotiation interfaces (RJ45), connect to Ethernet.
RS232	Used for debugging and maintenance.
USB	4×USB 3.0, connect to USB devices.
e-SATA	Connects to an external storage device.
VGA	Connects to a VGA display device.
RST	Reset button. The NVR will restart if you press and hold this button for at least 5 seconds.
Alarm input	24 channels, connect to alarm input devices.
12V DC output	Provide power for an external device.
Alarm output	8 channels, connect to alarm output devices.
PWR	Start or shut down the system.
miniSAS interface	2xminiSAS interfaces, connect to disk enclosures. Note: Do not unplug disk enclosures with power applied.
HDMI	Connect to HDMI display devices.

2 Installation and Connection

You need to remove the front panel to install hard disks. Prepare a #1 or #2 Phillips screwdriver.

Please contact your dealer for information about compatible hard disks.

Installing Hard Disks



CAUTION!

- Disconnect power before starting installation.
 - Wear a pair of antistatic gloves or an antistatic wrist strap during installation.
-

Follow these steps. The figures are only for illustration purpose.

1. Secure the hard disk to a pair of mounting brackets with screws. Each mounting bracket has a letter L or R on it, indicating left or right mounting bracket.



2. Unscrew the front panel with a Phillips screwdriver.



3. Align the hard disk with the slot and push in the disk gently.



4. Slide the disk gently until it clicks. Repeat the above steps to install all the hard disks.



5. Attach the front panel and secure it with screws.



Replacing a Hard Disk



CAUTION!

Wear a pair of antistatic gloves or an antistatic wrist strap throughout the procedure.

1. Unscrew the front panel. Gently pull the handles till the hard disk is detached from the backplane. Wait for at least 30 seconds till the hard disk stops operation, and then pull the disk out.



2. Remove the six fixing screws.



3. Replace the hard disk. See [Installing Hard Disks](#) for detailed steps.

Installing a Power Module (Optional)

The NVR supports the 100V-240V AC power module.



CAUTION!

- Make sure power is off before you start.
 - Wear a pair of antistatic gloves or an antistatic wrist strap throughout the procedure.
-

1. Loosen the screw and then remove the blank faceplate.



2. Insert the power module in place.



3. Fasten the screw.

Installing a Decoding Card (Optional)

The NVR supports 4-channel and 6-channel HDMI decoding cards.



CAUTION!

- Make sure power is off before you start.
 - Wear a pair of antistatic gloves or an antistatic wrist strap throughout the procedure.
 - Do not insert or remove a decoding card with power applied.
-

1. Loosen the two screws and then remove the blank faceplate.



2. Insert the decoding card in place.



3. Fasten the two screws.

Mounting the Device

Mount the NVR in a cabinet. Keep it away from any vibration source such as an electric generator.



CAUTION!

- The cabinet must be installed with a tray or slide rails. Do not use only mounting brackets to hold the NVR.
- Do not stack other devices on your NVR or place anything heavy on it. Otherwise heat dissipation will be affected.

Connecting the Device

The figure below shows how to connect the NVR to other devices.

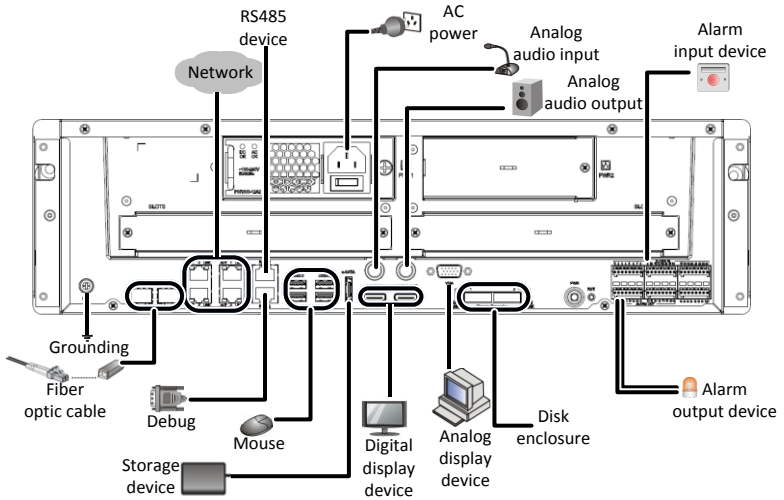

3 Startup and Shutdown

Before Startup

To avoid the risks of personal injury and device damage, make sure the following requirements are met before connecting your NVR to power.

The NVR is properly mounted.

Nothing is placed on the NVR.

All cables are correctly connected.

The power conforms to specifications.

Startup

Connect the NVR to power and then press the power on/off button.

Shutdown



CAUTION!

Do not disconnect the power supply or press the power on/off button when the NVR is operating or shutting down. This may damage the device.

Click **Menu > Shutdown > Shutdown**. A message appears. Click **Yes**.

4 Setup

After the NVR starts up, follow the wizard to complete the basic setup.



CAUTION!

The default password **123456** is intended only for your first login and should be changed immediately after login.

Adding an IP Device

Make sure the IP device to add is connected to your NVR via network.

1. Click **Menu > Camera > Camera**. The discovered IP devices are listed.
2. Click **+** for the desired IP device to add it.



Camera	Add/Del	Status	IP Addr.	Cam ID	Edit	Name
<input type="checkbox"/> D1	×	⬇	204.2.1.42	1	✎	IP Camera 01
	+	—	203.3.1.60		—	
	+	—	204.0.0.10		—	

Idle Receive Bandwidth: 195Mbps

Refresh Search Delete One-click Add Custom Add Back

















NOTE!

- To search a specified network segment, click **Search**.
- Normally, all the IP devices discovered can be added. If an IP device is online and live video from it is available,  appears in the **Status** column. Otherwise, check network connection and verify the username and password for the IP device. To modify the username or password, click  for the IP device in the **Edit** column.

Preview

Preview Window Toolbar





A toolbar appears when you click in a preview window.

Button	Name	Description
	PTZ Control	Click to control the PTZ camera. This button is effective only for PTZ cameras.
	Manual Recording	Click to start video recording to the hard disk on the NVR. To stop, click  .
	Instant Playback	Click to start playing the video recorded within the last 5 minutes and 30 seconds.
	Zoom	Click to zoom in on a certain area of the image.
	Image Config	Click to change image settings.
	Preview Snapshot	Click to take a snapshot. To view and back up snapshots, click Menu > Backup > Image .
	-	Move the mouse cursor over the button to view channel information.
	Two-Way Audio	Click to establish two-way audio with the camera. To stop two-way audio, click  .
	Turn on audio	Click to turn on audio. When audio is turned on, the button is replaced by  . To turn off audio, click  .
	Switch Camera	Click to change the camera in live view.

Button	Name	Description
	Exit	Click to exit the toolbar.

Status Icons in Preview Window

The following icons indicate alarm, recording and audio status.

Icon	Description
	Tampering alarm
	Motion detection alarm
	Recording
	Two-way audio
	Audio is on

Shortcut Menu

A shortcut menu appears when you right-click a preview window.

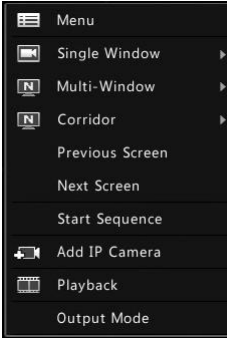
Menu	Description	Screenshot
Menu	Display the main menu.	
Single Window	Choose a camera for live video in full screen.	
Multi-Window	Choose the desired view.	
Corridor	Choose the desired view in corridor mode.	
Previous Screen Next Screen	Switch to the previous or next screen.	
Start Sequence Stop Sequence	Display live video in preview windows screen by screen.	
Add IP Camera	Open the camera window to add a camera.	
Playback	Play the current day's recording	

Menu	Description	Screenshot
	for the camera linked to the current preview window.	
Output Mode	Choose a desired output mode for live view.	

Scheduled Recording

1. Click **Menu > Storage > Recording**.
2. Select the desired camera, select **Enable Schedule**, and then click **Edit**.

3. Set the recording time and type as needed. Review the settings and then click **OK**.



NOTE!

Before selecting a recording type other than **Normal**, you need to enable the corresponding alarm type and configure alarm-triggered recording first. For example, if you select **Motion** from the **Type** drop-down list, you need to verify that motion detection and alarm-triggered recording have been enabled. For more details, please refer to the *Network Video Recorders User Manual*.

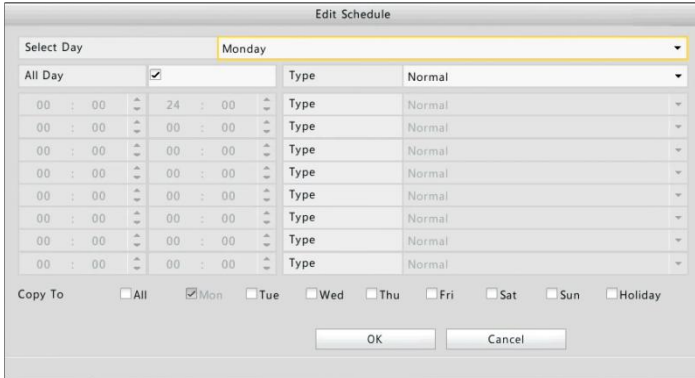

4. Click **Apply** to complete the configuration.

Playback

Right-click the desired preview window and then choose **Playback** from the menu. The current day's recording plays automatically.



Login to the Web Interface

Before you start, check that your PC is connected to your NVR through network.

1. Open the Web browser on your PC and visit the IP address of your NVR (192.168.1.30 by default). Install the plugin as prompted if it is the first time you log in. Close all Web browsers when the installation starts.
2. Enter the correct username and password and then click **Login**.
The default username is **admin** and password is **123456**.



CAUTION!

The default password is intended only for your first login and should be changed immediately after login.

5 FAQs

Problem	Possible Cause and Solution
The plugin cannot be loaded.	<ul style="list-style-type: none"> • Close all your web browsers when installation starts. • Disable the firewall and close the anti-virus program on your computer. • Enable your Internet Explorer(IE) to check for newer versions of the stored pages every time you visit the webpage (Tools > Internet Options > General > Settings). • Add your NVR's IP address to the trusted sites in your IE (Tools > Internet Options > Security).
The camera is offline.	<p>Click Menu > Maintain > System Info > Camera. The cause is displayed in the Status column. Common causes include disconnected network, incorrect username or password, insufficient bandwidth, and failed stream request.</p> <ul style="list-style-type: none"> • Check network connection and network configurations. • If it indicates incorrect username or password, check that the camera password set in the NVR is the one used to access the camera's Web interface. • If it indicates insufficient bandwidth, delete other online cameras in the NVR.

BOM: 3101COCF