

Contact Us: *FACTORY UTV LLC.*

9237 Beatty Drive Sacramento, CA 95826

Phone : (916) 383-2730

E-mail : info@factoryutv.net

Go online: www.Factoryutv.net

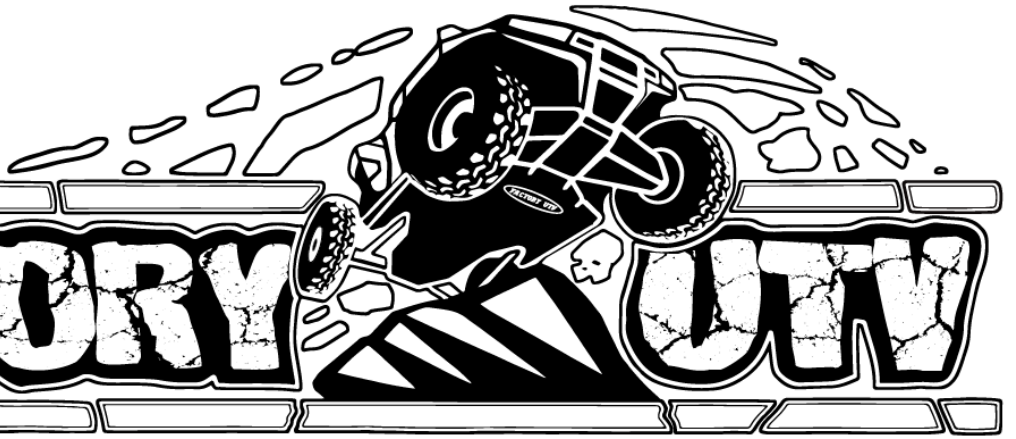

FACTORY UTV

U.H.M.W. Skid Plate / Under Armor Package

Ultra. High. Molecular. Weight. polyethylene all terrain skid plate / under armor kit for UTV's

Installation Guide

Honda

Pioneer 1000 & 1000-5 2016







Honda

Pioneer 1000 / 1000-5 2016

Skid Plate Mounting Hardware Kit

Front Differential Skid Hardware

	1/4" - 20" x 1" Flange Bolt	2
	1/4" - 20" x 3/4" Self Tapping Bolts	4
	1/4" - 20" Flange nuts	2
	Counter Sunk Washers	6

Rear Skid Hardware

	5/16" - 18" x 3/4" self tapping bolt	1
	"L" Shaped Mounting Bracket	1
	Counter Sunk Washers	7

Main Skid Hardware

	1/4" - 20" x 3/4" Self Tapping Bolt	12
	M6 - 1.0 x 35 mm Flange Bolts	1
	1" Nylon Spacer #S1	1
	Counter Sunk Washers #S1	22

This Kit Requires That You Re-Use Your Stock Skid Mounting Bolts (Minus The Stock Washers)

We recommend the use of a thread locker compound when securing bolts



Stock Skid Plate Removal

Honda Pioneer 1000 / 1000-5 (2016)

Note:
Save Stock Bolts
For Future
Steps

*Remove all
stock skid
plates*

*(16x) Total
stock bolts*

Note :
*Remove
plastic "pop bolt"*

#1
First:
Remove stock skid plate
Save all stock bolts
(for further steps)
*will not be reusing
stock washers*



Honda

Rear Skid Plate

Pioneer 1000 / 1000-5 (2016)

Note:
Direction of
"L" bracket.
Tighten bolts
securely

Install "L" Shaped Mounting Bracket

#1 Use: (1x) **Stock Bolt** in center of "L" bracket

#2 Use: (1x) **5/16th" - 18"x 3/4" Self Tapping Bolt**
Fasten rear lip of "L" bracket to the top of the rear cross member.
Tighten all bolts securely before going on to step (#3)

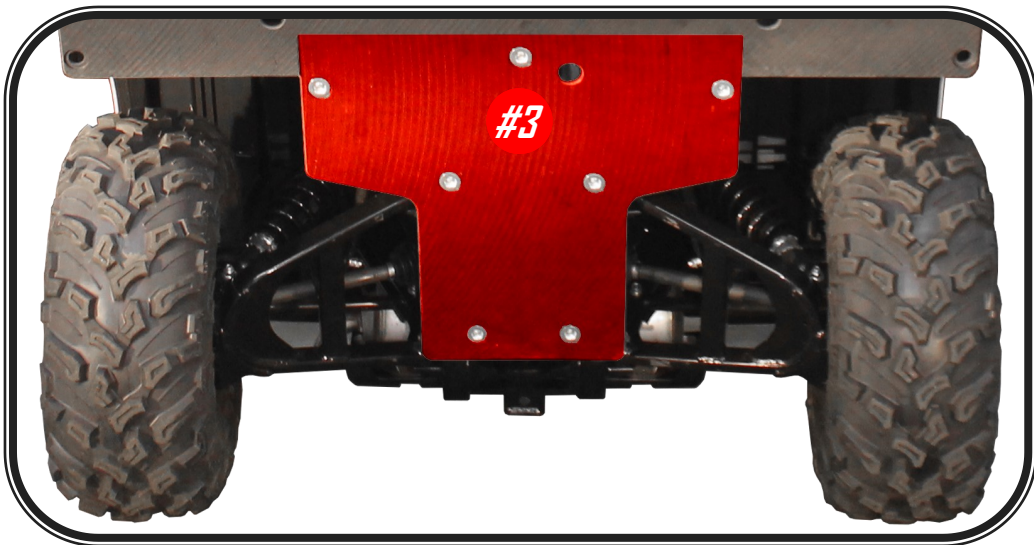
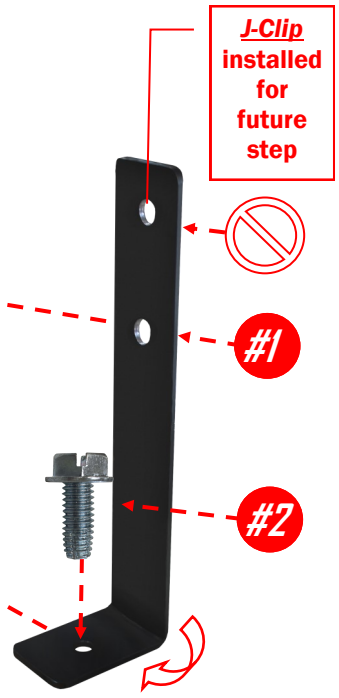
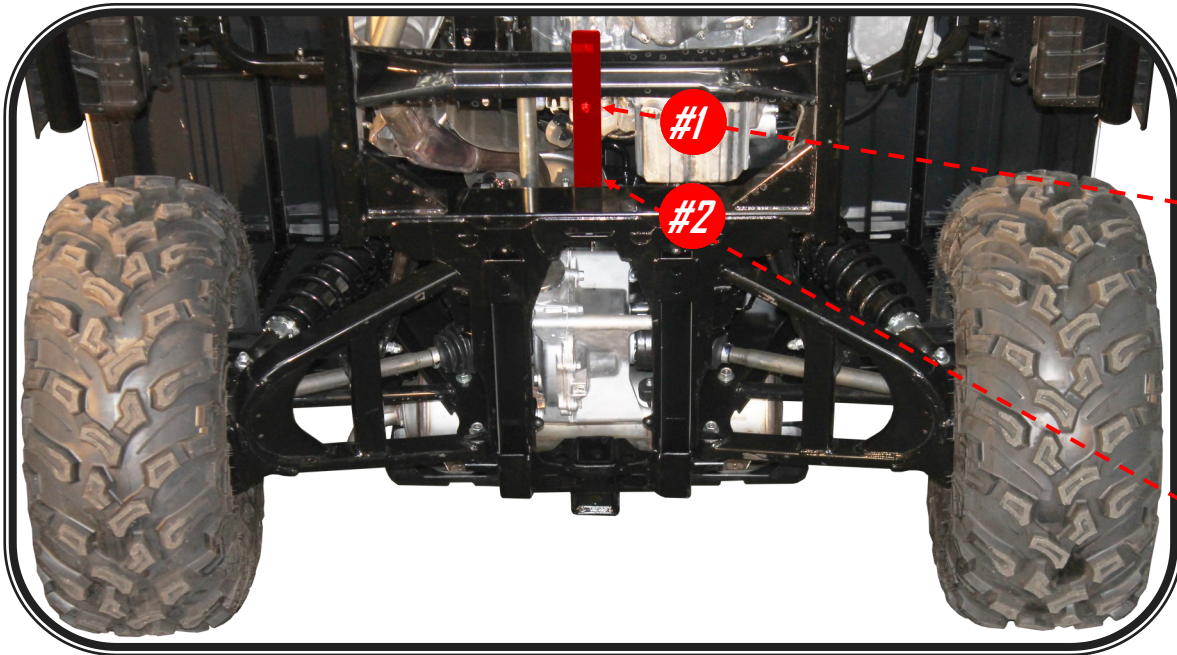

#3

Install Rear Skid Use :
(7x) **Stock Bolts** W/
(7x) **Counter Sunk Washers**
(Provided)

Finger tighten bolts
for adjustments

Honda Pioneer 1000 / 1000-5 (2016)

Main Skid

Note:
Figure (#2a)

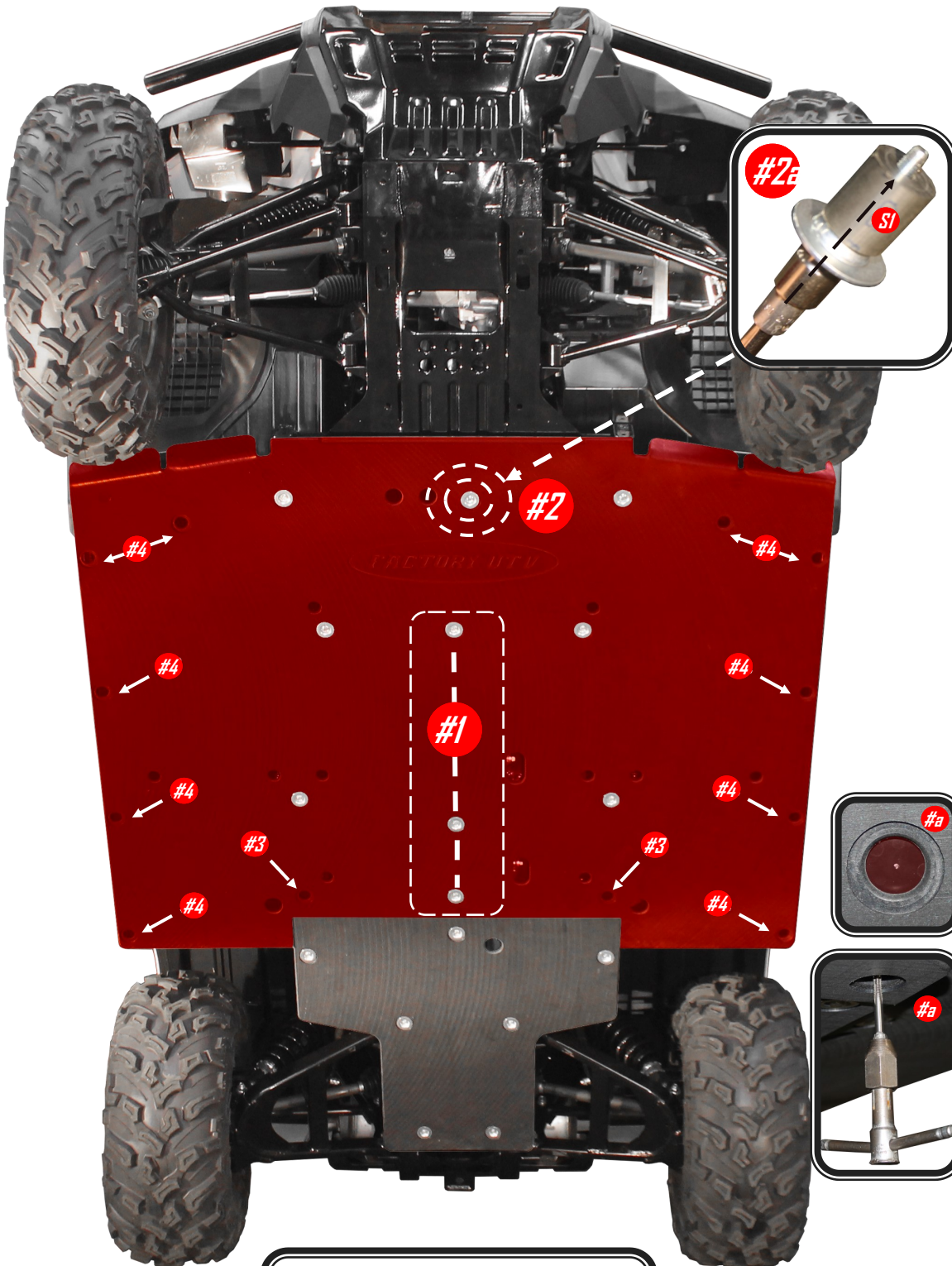

Main Skid Plate
Use remaining:
Stack Bolts with
Counter Sunk Washers

#1

Install :
Fasten center bolts first,
align tongue and groove
On the edge of rear skid plate.

Finger tighten all bolts

#2

At center top install:
M6 - 1.0 x 35 Flange Bolt
with **Nylon Spacer (#S1)**
and **Counter Sunk Washer,**
Through mounting hole
(see fig. (#2a))

#3

Starting with the (2x) rear
mounting holes on main skid.
Make a score or mark
at the center of the holes.
(see fig. (#a))

Drill a 13/64th inch hole,
thread **1/4"-20"** tap if desired

Use: 1/4"-20" x 3/4"
Self Tapping Bolts
for steps #3 and #4

#4

Follow the same procedure
as mentioned in
step (#3) for all side bolts.

When steps are completed
Tighten All Bolts Securely

Honda Front Diff Skid Pioneer 1000 / 1000-5 (2016)

Note:
Make sure
marked holes align
prior to drilling

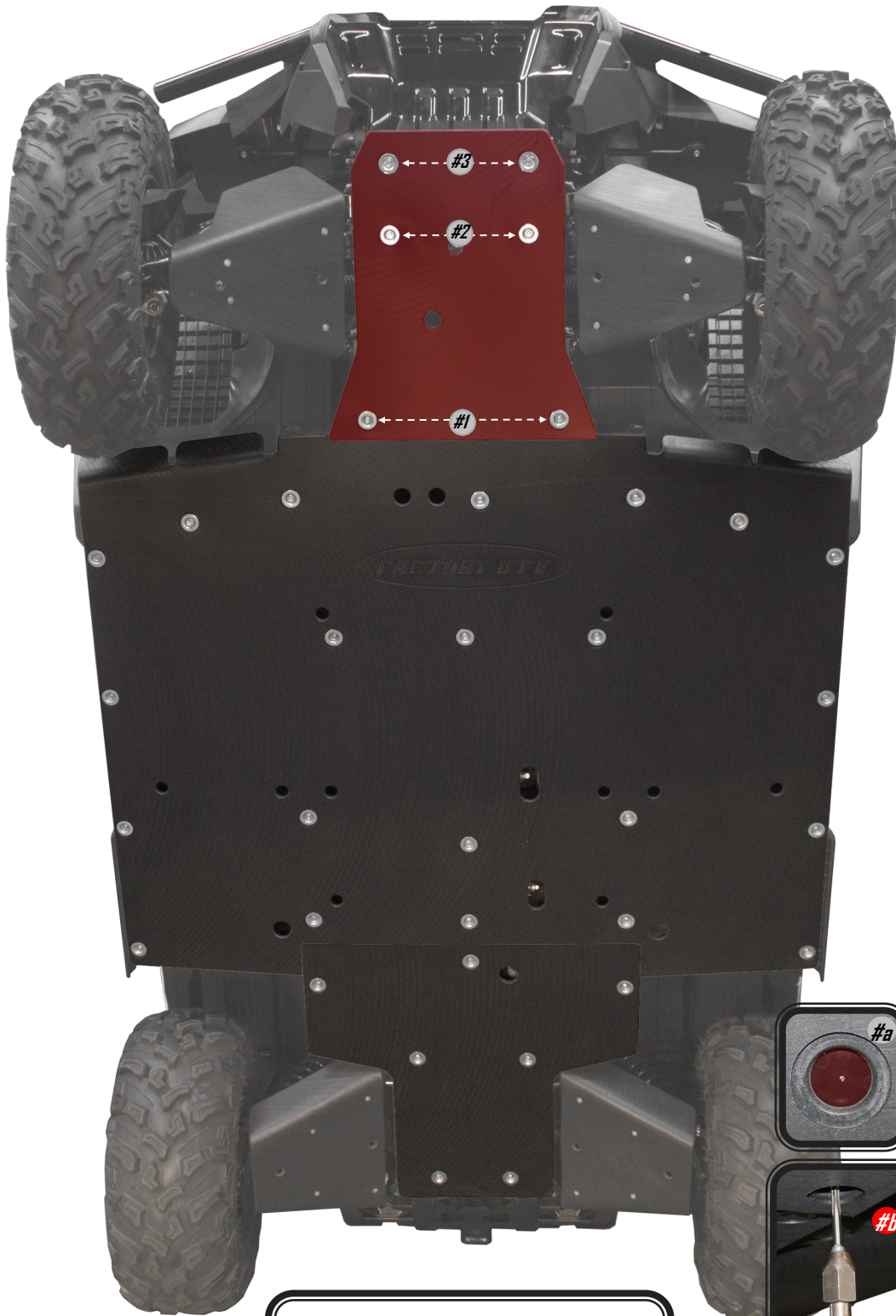

When steps are completed
Tighten All Bolts Securely

Install: **Front Differential (Diff) plate**

Hold diff. plate in place,
align with
tongue & groove on main skid:
Make a score or mark
the center of the holes
(see fig. (#a))

#1

Drill 1/4" inch holes
Use: (2x)

**1/4"-20" x 1" Flange Bolts w/
1/4"-20" Flange Nuts and
Counter Sunk Washers**
Reach behind chassis to secure.

#2 & #3

Make a score or mark
the center of the holes
(see fig. (#a))

Drill 13/64th inch holes,
thread **1/4"-20" tap** if desired
(see fig. (#b))

Use:

1/4"-20" x 3/4" Self Tapping Bolts
with
Counter Sunk Washers
After installing (#2)
Bend upper lip to nose
while fastening (#3)

Honda A-Arm Guard Instructions

Pioneer 1000 / 1000-5 (2016)

Note:
Direction of
A-Arms &
Spacers



Front A-Arm Hardware
(8x) 1" x 1" D Clamps 
(8x) Ny-Lock Nuts
(8x) 1/4" Gold Washers
(8x) 1/4"-20"x 1"
Counter Sunk Bolts

Rear A-Arm Hardware
(8x) 1" x 1" Box Clamps 
(8x) Ny-Lock Nuts
(8x) 1/4" Gold Washers
(8x) 1/4"-20"x 1"
Counter Sunk Bolts

Front A-Arms

(Front A-Arm Guards)
Install : A-Arm guard,
Hold in place Align & install
 Use: 1" x 1" - "D" Clamps with/
1/4" - 20 x 1" counter sunk bolts
1/4" Gold Washers & Ny-Lock Nuts
finger tighten bolts to allow adjustment.
Tighten all bolts securely when done

(Rear A-Arm Guards)
(using similar method)
Install : Rear A-Arm Guards
 Use: 1" x 1" "Box" Clamps with/
1/4" - 20 x 1" counter sunk bolts
1/4" Gold Washers & Ny-Lock Nuts
finger tighten bolts to allow adjustment.
Tighten all bolts securely when done

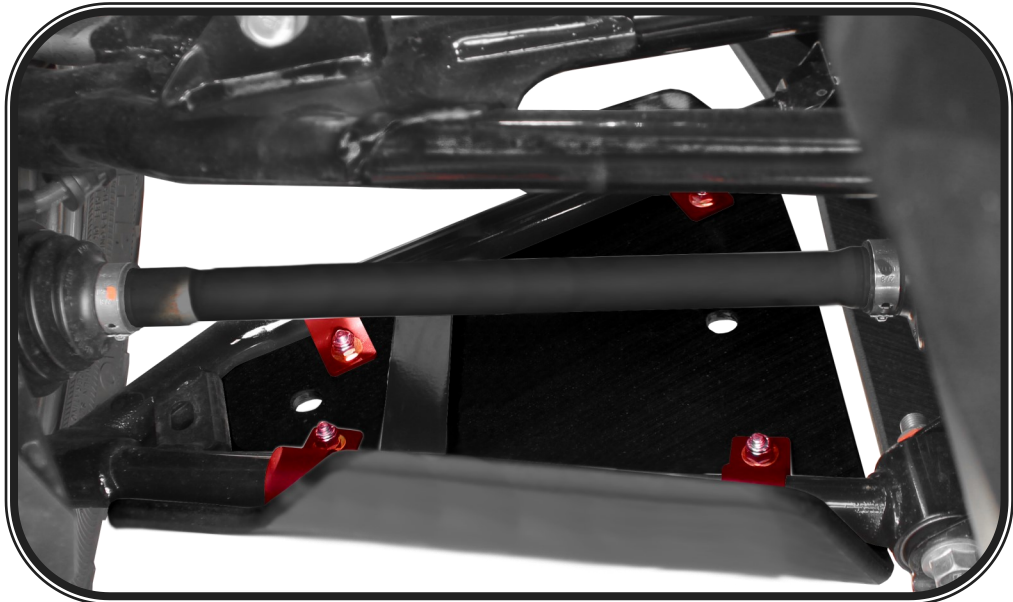

Rear A-Arms

