



# OWNER'S MANUAL

## POWER WHEELCHAIR

W5521



Read and follow all instructions, warnings, and notes in this manual before attempting to operate your power wheelchair for the first time. If there is any information in this manual which you do not understand, or if you require additional assistance for assembly or operation, please contact with your authorized local provider.

These symbols below in this manual are used to identify warnings and important information. All of them are very important to your safety. It is strongly recommended that you should read and understand them completely.



**WARNING**

Failure to heed the warnings in the manual may result in personal injury.



**ATTENTION**

Failure to heed the cautions in the manual may result in damage to the powered wheelchair.

## 1. INTRODUCTION

1.1 This product integrates advanced technology with modern style. Especially, its structure for quick dis-assembly and assembly are very convenient for you to store or place at the trunk of your vehicle while traveling. We are certain that the design features, excellent performance and trouble-free operation of this product will ensure your daily life more convenient.

1.2 This product is suitable for all the disabled persons, the elderly and the infirm who have difficulty in walking. The maximum user weight is 265lbs.

1.3 This product is of an outdoor type. It is of Model CROMEX 5521.

1.4 This product is suitable for an outdoor use and the flat streets near buildings for a middle distance, but not for the grass, gravel, or slope of more than 10 degrees and motorized roads, rainy or snowy days, either.

## 2. SAFETY USE

2.1 This power wheelchair is energy, non-asepsis, reusable product without chemical substances.

The safe and period of validity for wheelchair on the clinical use not only depends on its structural strength, but also on the user usage and use of the product environment, user habits, whether in accordance with the periodic maintenance, maintenance and other factors.

Our products are valid from the date of production for 7 years.

## 2.2 Instructions before use

2.2.1 If not completely read and understand the user manual, please do not drive.

2.2.2 The maximum loading capacity is 265lbs (fig.A) please do not overload driving. And it is single use, please do not carry passengers.

2.2.3 Please do not drive after drunk or too tired.(fig.A)

2.2.4 Do not drive at night or in the case of a unclear line of sight.

2.2.5 Please self-test before driving and refer to the manual section 5.3 "Commissioning" and 6.2.2 "Practice before operation" if driving for the first time.

2.2.6 This wheelchair is not waterproof, do not expose in rain and snow as well as drive in rain or snow.(Fig.B)

## 2.3 Attention during using

2.3.1 This power wheelchair can drive on a good flat surface, do not drive on muddy, rugged, soft, narrow, icy road, bad roads without guardrails or waterway. (Fig.C)

2.3.2 This power wheelchair has the certain ability of groove obstacle, at this time you should reduce the speed and travel slowly.

2.3.3 This power wheelchair has the certain climbing ability, the climbing angle is  $\geq 6^\circ$ , but within  $10^\circ$ .(Fig.D)

2.3.4 Please avoid driving in the crowds, traffic and other places with heavy traffic.

2.3.5 Please ensure that the controller system fix well, joystick is straight and correct. Sit well and promptly fasten protective tape, keep your head as backward as possible and lean against the backrest in case of bumps on the road, which may lose control.

2.3.6 Press the on/off button, firstly check if the current fastest speed setting is appropriate for yourself operating proficiency, or it should be adjusted for safety; We recommend drive slowly at the beginning for every use, and gradually accelerate as well.

## 2.4 (EMI) Electromagnetic Interference

Your wheelchair may be traveling in the areas affected by electromagnetic interference from some radio transmitters such as radio, wireless intercom, mobile phones and radars etc. In these cases, your wheelchair's driving may be affected by them. Electromagnetic interference may affect the control system of the electric wheelchair. Some disturbances may cause brake failure, automatic start or runaway, and may cause permanent damage to the control system.

### 2.4.1 Electromagnetic Interference Classification

•Short-band radio transceiver. These radios have antennas, such as radio waves in the urban bands, walkie-talkies, cell phone network systems and signal transmission devices.

•Medium-band mobile radio transceiver. These are usually installed in the building or outside the vehicle antenna. For example: police, fire, tax, medical ambulance and other radio transceivers.

•Large band radio transceiver. These are usually installed on the tower in the antenna, such as: commercial radio TV transmission system.



**ATTENTION**

Wheelchair and battery chargers meet GB / T 18029.21-2012 Requirements and test methods for electromagnetic compatibility of power wheelchair, electric scooters and battery chargers, as well as Requirements of YY0505-2012 medical electric equipment-part 1-2:common safety standards:electromagnetic compatibility requirements and experiments.



**ATTENTION**

The chair during driving may be affected by Electro-Magnetic Interference(EMI). Such interference may be from mobile phones, EAS system, etc.

2.4.2Prevention of Electromagnetic Interference

- Do not use hand-held radio transceivers when the wheelchair power is turned on, such as mobile phones, radios, etc;
- Avoid close to the radio transmission system, such as radio stations, television stations;
- If the electric wheelchair can not control or brake failure, please contact our company or dealer.

**3.STRUCTURE AND PERFORMANCE**

3.1This power wheelchair consists of the main parts including the front wheel, drive wheel, frame, joystick, motor with mechanism, armrest, push handle, backrest, seat base, footrest, battery case, and charger,the structure is shown as below.



### 3.2 Product Characteristics of the Power Wheelchair

- Classification by anti-shock type: wheelchair is internal power supply;
- Classification according to the degree of anti-shock: wheelchair belongs to the B-type application part;
- Classification according to the degree of protection of the feed: IPX0;
- Safety degree when used in flammable anesthesia mixed with air or flammable narcotic with oxygen or oxidized nitrogen Category: Non-AP or APG equipment;
- By operating mode: continuous operation;
- Rated voltage and frequency of wheelchair: DC 24V;
- Input power of wheelchair: internal power supply equipment;
- Whether the wheelchair has a protective effect on defibrillation effect: No;
- Whether the wheelchair has a signal output and input part: No;
- Permanent installation of equipment or non-permanent installation of equipment: mobile devices.

### 3.3 ELECTRICAL DIAGRAM OF POWER WHEELCHAIR

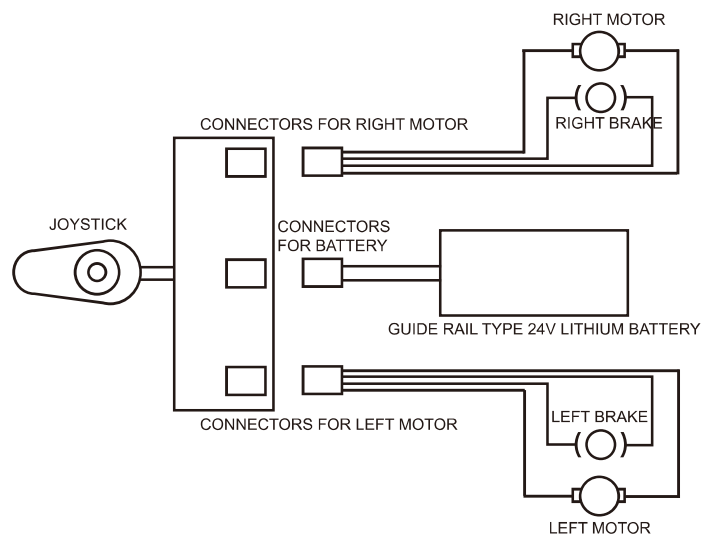

### 3.4 Product Software REV.

Controller version of Power wheelchair W5521 is V1.6.

## 4. SPECIFICATION.

Overall Dimensions(L*W*H)	42.5*24.4*38.6IN
Folding Length	15.7IN
Folding Width	24.4IN
Folding Height	32.7IN
Effective Seat Depth	17.7IN
Seat Width	15.7IN
Effective Seat Width	19.3IN
Seatback Height	22IN
Seat Surface Height at Front Edge	20.9IN
Distance from footrest to seat	15.7IN
Leg-to-seat Surface Angle	118°
Armrest Height	9.1IN
Front-of-armrest to Backrest	14.6IN
Horizontal Displacement of Wheel Axle	3.9IN
Seat Plane Angle	2°
Backrest Angle	10°
N.W. of wheelchair	55.1LBS
Weight of the heaviest part(motor)	13.5LBS
Obstacle clearing capability	≥1.6IN
Maximum Speed	≤3.7mph
Braking Distance at flat surface	≤59.1IN
Minimum Turning Radius	≤47.2IN
Weight Capacity	265LBS
Maximum Potential Range	9.3mi
Static Stability	≥9°
Dynamic Stability	≥6°
Slope Performance	9°
Climbing Ability	≥6°
Motor Type	24V/200W*2
Battery Type	24V 10AH lithium battery
Max. Output Current of Controller	50A
Max. Output Current of Charger	2A
Front Wheel	Inflate-free tire;Outside size 8IN
Rear Wheel	Inflate-free tire;Outside size 12IN

Note:

① The weight capacity is tested with a dummy or personnel of same weight.

② Maximum Potential Range is tested on flat road with average speed. It will vary due to drive surface, operation habit, etc.



## 5.INSTALLATION, FOLDING AND DEBUGGING

### 5.1 Installation

Open the packing box, take out the vehicle, flip down the pedal, and insert the battery into the track till bottom easily; Insert the joystick into the armrest pipe and tighten the knob(Fig. 1)

### 5.2 Folding

5.2 Pull it outwards and backwards with one hand on the backrest and another on the bottom pole.(fig.2)



fig.1

### 5.2.1 Installation and adjustment of joystick

The installation of the joystick can be adjusted to the most comfortable position according to the height of the driver's body and the length of the arm. When adjustment is needed, loosen the nut on the armrest first, and the joystick rod can be retracted. (Fig. 3) When retracting to your most comfortable position, tighten the nut (it must be tightened) to ensure that the joystick is fixed, otherwise the joystick may fall off and cause unnecessary accidents.



fig.2

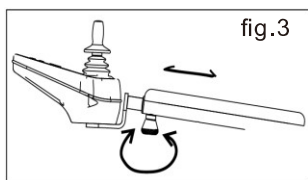

fig.3

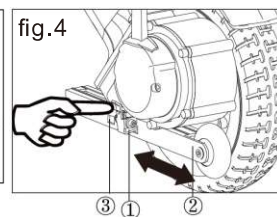

fig.4

### 5.2.2 Anti-tip wheel adjustment

The anti-tip wheel is a safety device to prevent the wheelchair from overturning while driving on the slope. It can be adjusted according to your need (Fig. 4). When you only need to use it on flat ground indoor, you can shrink the anti-tip wheel frame inward. When you need to drive on a slope, you must extend the anti-tip frame outward to the outermost gear. When adjusting, as long as you press the stopper ① on the anti-tip wheel frame by hand, the anti-tip wheel frame ② can move inward or outward. When the position is confirmed, you can then clip the stopper into the hole ③.



Warning! It may cause severe injury once wheelchair turnover backwards, properly use of anti-wheel could reduce the risk of turnover.

### 5.2.3 Brake lever adjustment

A set of brake lever device is attached to the driving motor. When the brake lever is set to the "A" position the wheelchair is in the electric mode. At this time, the wheelchair can only be driven by electricity and cannot be moved by hand. When the brake lever is set to the "B" position, the wheelchair is in manual mode and can only be pushed by hand. (Fig. 5)

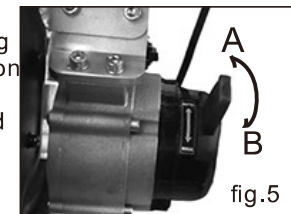

fig.5



Warning! It is prohibited to switch to manual mode without any retinues, as it may cause personal injury.  
Warning! Do not leave the wheelchair in manual mode on the slope, which may cause the wheelchair moving down resulting in personal injury.

### 5.2.4 Armrest adjustment

The armrest of this wheelchair can be flipped up for the purpose of getting on/off the chair. To flip up the armrest, just press the lock button under the armrest to flip up the armrest at the same time(Fig. 6). When you want to flip down the armrest, just push down the armrest till you hear a "click", it means that the lock button has been locked into the armrest. The armrest is now reset.

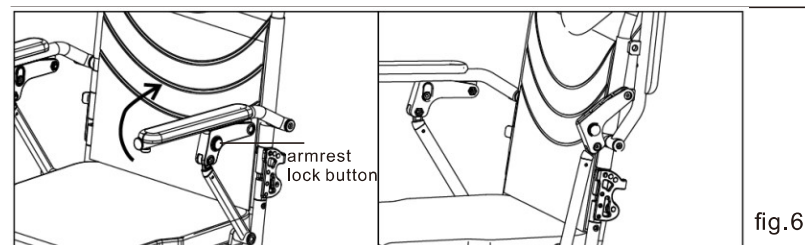
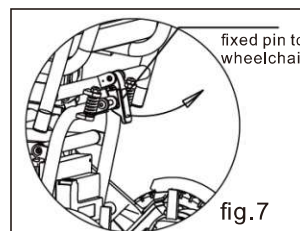

fig.6

### 5.3 Folding

When the wheelchair needs to be folded, open the latch at the rear of the wheelchair outwards, and push the backrest forward at the same time to release the latch from the fixing pin (Fig. 7). Push the backrest forward again with one hand, lift the front part of the seat with another hand, and then the whole wheelchair will be folded. After folding in place, flip up the foot pedal to save space(Figure 8).



fixed pin to wheelchair

fig.7



fig.8

## 6. USEING AND OPERATION

### 6.1 Using

6.1.1 Controller: an absolutely necessary electrical device. All electronic components to operate the wheelchair are integrated to the device. Usually, the controller is installed on an armrest, connected together with the motors and batteries to the power box.

● **Switch button:** Switch button supplies the power for control system for electronic equipment, then equipment supplies the power for motor of wheelchair. Do not use the switch button to stop the wheelchair unless an emergency situation. Otherwise it may shorten the life of the wheelchair drive components.

● **Joystick:** The joystick is mainly used to control the wheelchair's movement including its speed and direction (forward, backward and left or right etc). The further you push the joystick from its central position, the faster the wheelchair moves. Whenever you release the joystick, it will automatically go back to the center and the brake will be automatically operative to stop the wheelchair.

● **Horn button:** The horn will sound if you press this button.

● **Speed Up/Down Buttons and Speedometer:** After turning on the power, the speedometer shows the current maximum speed setting. This maximum speed setting can be adjusted through the speed up button or speed down button by user.

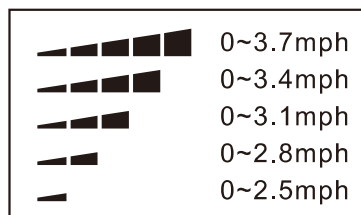
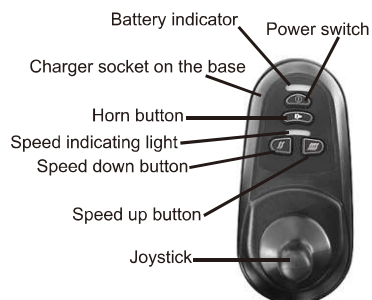

#### WARNING

If your wheelchair moves accidentally, please immediately release the joystick and the wheelchair will stop automatically. (fig.E)

● **Charger Socket:** It is only used to this wheel chair. Do not use the socket to supply power to any other electrical equipment. Otherwise, it may damage the wheelchair's control system or its E.M.C performance (Electromagnetic tolerance).



#### WARNING

If you connect any devices other than the supplied battery charger into the socket, causing damage to the control system, then the warranty is invalid.

### 6.1.2 Batteries and Its Usage

Fully charge your new battery prior to its initial use. This brings the battery up to about 90% of its peak performance level; Give the battery another full charge of 5-8 hours and operate your wheelchair again, the batteries will now perform at over 90% of their potential; After four or five charging cycles, the batteries will top off at 100% charge and last for an extended period. Please replace a new battery when the battery failure, and the used battery must be returned to supplier because of environmental pollution.

Type	Lithium battery
Voltage	24V
Amperehour	10AH



#### ATTENTION

Do not use your wheelchair when the temperature is less than -25 C or above 50 C. (Fig.F)

### 6.1.3 Charger Usage

The battery charger is an important part of the wheelchair. The off-board charger attached to this product can charge its batteries quickly and easily to make your wheelchair the best.



## ATTENTION

The charge of 24V/2A supplied by our company meets the requirements mentioned in Section I ( «General Safety Requirements» ) of medical electrical equipment GB9706.1-2007. The battery must be charged by the charger supplied by us. Any other types of chargers are forbidden.

Please note below tips when charging:

- Be certain the controller is powered off and the wheelchair is in the electric mode, instead of the manual mode.
- Connect the 3-pin output plug of the charger to the controller. (Fig.14)
- Connect the power plug of the charger to the standard wall outlet.
- The red LED on the charger lights indicating that charging is in progress. The green LED on the charger lights when the batteries are fully charged.
- We recommend you to charge the battery for 5-8 hours.
- Remove the charger and power plug when fully charged, and put them into the bag behind the seat rest.

### 6.1.4 Safety Belt

For your safety, the safety belt must be fastened before you operate the wheelchair. (fig.13)

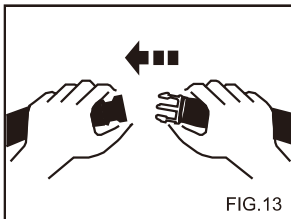

FIG.13



FIG.14

### 6.1.5 Overload and Undervoltage Protector

The overload and undervoltage protector is set for the wheelchair' s safety, and implement the protection function through the on-off of the protective board installed inside the lithium battery. Once motors overload or undervoltage, it will trip to cut off the power to prevent the motors and electric components from damage. The protector function could be recovered by charging the wheelchair or reconnect the batteries.(fig.14)

## 6.2 Operation

### 6.2.1 Preparation before operation

- Do not turn on the power switch when sit on the power wheelchair, and do turn off the power switch when get off from the wheelchair.
- Please fold the pedal first then hold the armrest to sit on the wheelchair; Do not get off the wheelchair by stepping on the pedal. Otherwise the wheelchair maybe turned over, which is dangerous.

### 6.2.2 Practice before operation

- Find a spacious place like square and have an assistant to help you practice until you have enough confidence to operate it.
- Be certain to shut down the power when up and down the wheelchair, and set a speed you need through speed adjustment button.
- We recommend you set the lowest speed until you can operate the electric wheelchair skillfully. (fig.a)
- To practice the stop operation, forward and backward. Push the handle, the wheelchair move to anywhere you want.(fig.b)
- Firstly, ensure that it is the lowest speed when practice forward operation. After Skilled, you can practice "S" shaped turn. After you are familiar with "S" shaped turn, to practice backward operation, and pay attention to the speed control setting. And the backward speed should lower than forward speed.(fig.c)

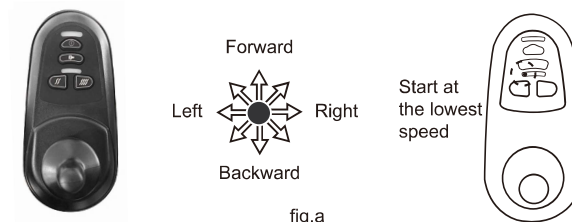

fig.a



fig.b



fig.c

### 6.2.3 Operation

Please do it according to precautions operation.



**WARNING**

Please do not operate your wheelchair at manual mode without any assistance. Otherwise, personal injury may be caused.



**WARNING**

Please do not attempt to set your wheelchair to manual mode when you sit on it, otherwise may cause personal injury. Please ask help from nursing personnel. Please do not set your wheelchair to manual mode when it is at slope. Otherwise the wheelchair will glide without control, resulting in personal injury.

## 7.FAULT DIAGNOSIS AND TROUBLESHOOTING

For your convenience of operation, this product has an automatic fault warning function. Once the wheelchair system malfunctions, the LEDs on the controller will flash with alarm sounded by the horn. You can find where a fault is according to information in Table 8.

If the fault still exists after checking based on table 8, Please consult your service agent immediately.

Table 8

LED display	Fault Diagnosis	Troubleshooting	Remark
1 LED lamp flashes	Low voltage, undervoltage	Charging	
2 LED lamp flashes	The left motor failure	Check the motor and wiring harness	
3 LED lamp flashes	The left motor failure	Check if the brake lever at the correction position, if the brake is damaged	
4 LED lamp flashes	The right motor failure	Check if the brake lever at the correction position, if the brake is damaged	
5 LED lamp flashes	The right motor failure	Check if the brake lever at the correction position, if the brake is damaged	
6 LED lamp flashes	Overcurrent of controller	Check if the brake is disengaged, if the wheel is locked-rotor	
7 LED lamp flashes	Failure of the joystick	Check if the joystick is in the center	
8 LED lamp flashes	Failure of the controller itself	Controller fault	

## 8.SAFETY DEVICES AND ACCIDENT TREATMENT

8.1 Safety belt: Refer to instruction manual 6.1.4

8.2 Overload Protector: Refer to instruction manual 6.1.5

8.3 Please release the joystick whenever there is a wheelchair fault, the wheelchair will be stopped.

## 9.MAINTENANCE AND REPAIR

### 9.1 Maintenance

Like other motorized vehicle, your power wheelchair also requires routine maintenance. Some checks can be performed by yourself, others you can ask for assistance from your service agent. Preventive maintenance is very important. If you follow the maintenance and checks in this section, your wheelchair will give you years of trouble-free operation. If you have any doubt about your wheelchair's care or operation, please contact your service agent or our after-sale service dept.

#### 9.1.1 Humidity

Your wheelchair, like most electrical and mechanical equipment, is susceptible to external conditions. In any case, the wheelchair should be avoided damp environment. Direct or prolonged exposure to water or dampness could cause the wheelchair to malfunction electronically and mechanically. Water can cause electrical components and the wheelchair's frame to corrode.

#### 9.1.2 Temperature

- Some parts of your wheelchair are susceptible to temperature.
- In extremely cold temperature, the battery may be frozen. Special temperatures may cause a lot of factors to freeze, like charger type, usage, battery components (such as sealed lead-acid batteries or gel batteries);
- Temperature above 55° may cause your wheelchair decelerate.

#### 9.1.3 General Guidelines

- Avoid beating the controller, especially the joystick.
- Avoid prolonged exposure of your wheelchair to extreme conditions, such as hot, cold or moisture environment.
- Keep the controller clean.
- Check all electric connections, including the cable and connectors of the charger, and ensure that they are all tight and secure.
- If only red LEDs on the Battery Gauge lights, the batteries are nearly running out of charge. You should recharge the batteries as soon as possible. We recommend charging the battery for 5-8 hours.



- The frame surface has been sprayed with a clear sealant coating. You can apply a light coat of car wax to make the surface keep a high gloss.
- Check all cable connections. Make ensure they are fastened and are not corroded. The battery must be placed in the battery area, flat, the battery plug inward, relative display, refer to the correct connection on the main frame label;
- All wheel bearings are lubricated and sealed. Do not need to lubricate them.
- Check if there is loose phenomenon for wheel hub, drive device, and chair itself, if loose, please screw tightly in time.



**WARNING**

Never let the battery freeze, nor charge the frozen battery. Otherwise may cause personal injury and damage to the battery.

9.1.4 Maintenance after use

- Turn off the power(please disconnect all the connectors if not use for long time.)
- Inhibit children or unconscious person to use the wheelchair.
- Store the wheelchair in normal temperature to prevent reformation so that it keeps its performances for long period.
- Clean the wheelchair with a clear and soft cloth and dry it. Never use any chemicals to clean it.(to prevent deformation and discoloration).
- Remove the cloth cover of the seat rest to be washed if it is dirty, and then dry it for use.

9.1.5 Daily Checks

In order to keep the wheelchair in good condition, you should check before each use. And to maintain the weekly, monthly, semi-annual investigation.Refer to table 9 for the inspection item.

Table 9

Inspection Items	At any time	Weekly	Monthly	Six monthly
Wheel hubs, Driving mechanism and fasteners			○	
Joystick function	○			
Brake System	○			
Connection		○		
Battery Condition	○			
Tire Condition			○	
Inflation condition of rear wheels	○			
Frame Condition				○
Motor and actuator condition				○
Front Wheel Condition		○		
Pureness	○			

9.1.6 Cleaning

Way of cleaning as below.

Clean the wheelchair with dry cloth.



- Never wash your wheelchair with water or expose directly to water.
- Surface of wheelchair frame is coated with a protective coating. Therefore, it is very easy to wipe it clean with a damp cloth. Never use any chemicals to clean the vinylon seat and armrest, as they may cause the latter slip or chapped. You can use a damp cloth and neutral soapy water to clean them, and then dry thoroughly.

9.2 Repairment

9.2.1 Users could repair or replace some spare parts like armrest, push handle cover which could be self-maintained or replaced by users under the instructions of after-sales service staff of our corporation or the dealers'.

9.2.2 Within the warranty, our corporation or the dealers will maintain or replace the faulted spare parts, like motor, battery, charger, controller, bearing, shaft sleeve, etc., due to material or manufacturing defects free of charge.

9.2.3 The spare parts like motor, controller, etc. which are confirmed by the after-sale staff of our corporation or our dealers' to be dissembled could be sent to our corporation or the dealers for maintenance.

9.2.4 Please contact your distributor or the after-sale service dept. of our corporation for any questions regarding the mantainence of power wheelchairs. Please refer to 12.1 Product Warranty.



**ATTENTION**

In order to guarantee the quality of power wheelchair, Please contact us or our dealers to replace the spare parts with same models and specifications if the consumable parts like batteries, tyres, controller, motors and charger, etc. need to be replaced. The maintenance should be proceeded at our corporation or the dealers' maintenance dept.

---

## 10. TRANSPORTATION AND STORAGE

### 10.1 Transportation

You can load and transport according to the shipping marks and graphics. For details, see the attachment.

### 10.2 Storage

Your wheelchair should be stored in a clean indoor environment with ambient temperature of 0°C-50°C, relative humidity ≤80%, good ventilation and free from corrosive gas. Remove the batteries from the wheelchair prior to storage. Otherwise, the frame may rust and the electronics may be damaged.

## 11. OPENING AND CHECKING

Please check if any parts missed or damaged.

NO.	Name	Quantity	Remarks
1	Power wheelchair	1	Model: CROMEX 5521
2	Charger	1	Model: HP0060W(L2)-M
3	Manual	1	
4	Pedal	1	
5	controller	1	

## 12. QUALITY ASSURANCE

### 12.1 Warranty

#### 12.1.1 5-year warranty for wheelchair frame

12.1.2 Within 1 year from the purchase date, for the following parts, we will supply free maintenance and/or replace service for original customer after the dealer check there are materials and production defects.

- Electrical control or joystick system
- Motor/Drive System
- Bearing and shaft sleeve







### 12.2 12-month warranty for the batteries.

Please note the warranty service is provided by your dealer, and finally finished by our after-sales department and dealer together.

#### Out of warranty

- ABS plastic cover shell and rubber pad
- Tyre
- Interior decoration and seat
- Damage by abuse, wrong operation, accidents and negligence
- Damage by wrong operation, maintenance and storage.
- Business use or other abnormal use.

The name and symbols of the signs

No.	Sign	Meaning
1		Fragile objects inside the packaging, please handle with care.
2		Keep the packaging up during transportation.
3		Keep the packaging avoid from rain
4		The max. layers of stacking same packaging is 2.
5		Hand hook are forbidden when carry on transport the packagings
6		Application type B.
7	IPX1	Plummeted Droplets (condensed water for example do not damage the electrical appliance)
8		Warning, Attention, Caution.

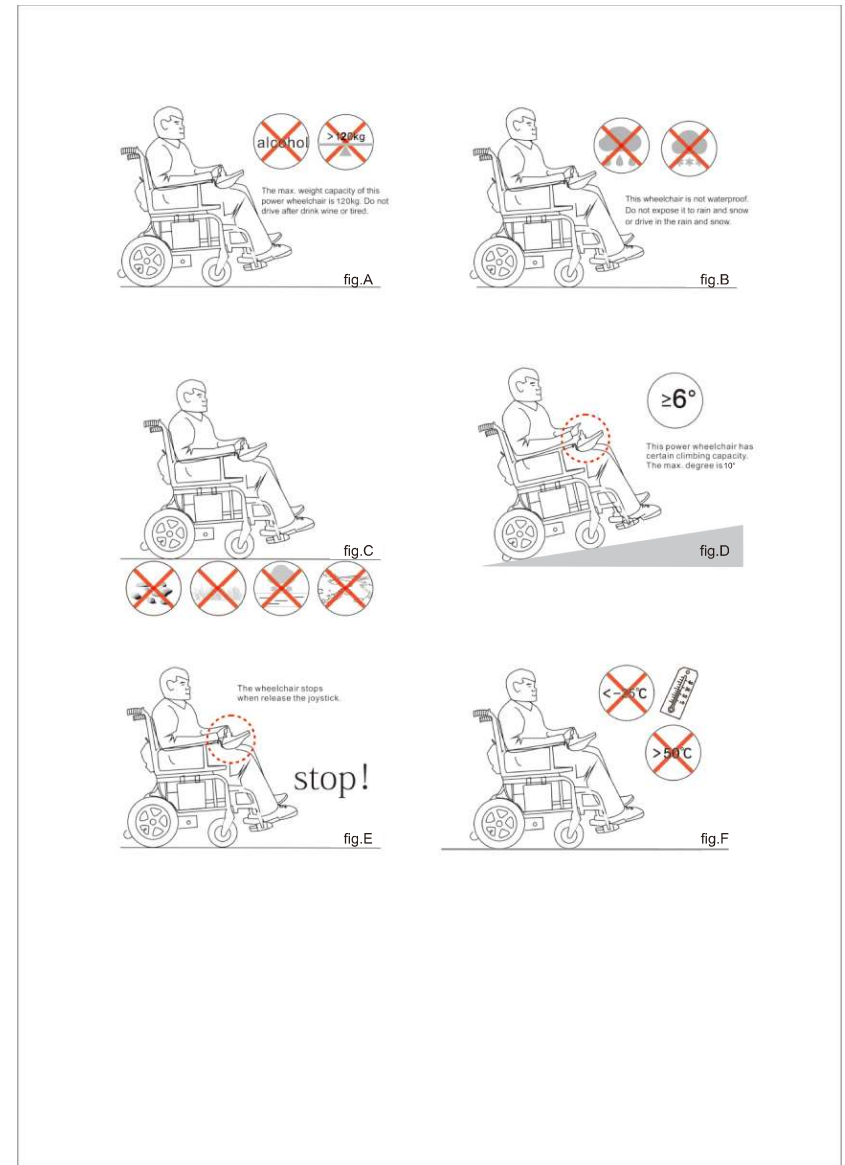

<b>1.INTRODUCTION.....</b>	<b>1</b>
<b>2.SAFETY USE.....</b>	<b>1-3</b>
<b>3.STRUCTURE AND PERFORMANCE.....</b>	<b>4-5</b>
<b>4.SPECIFICATION.....</b>	<b>6</b>
<b>5.INSTALLATION, FOLDING AND DEBUGGING.....</b>	<b>7-8</b>
<b>6.USEING AND OPERATION.....</b>	<b>9-13</b>
<b>7.FAULT DIAGNOSIS AND TROUBLESHOOTING.....</b>	<b>13</b>
<b>8.SAFETY DEVICES AND ACCIDENT TREATMENT.....</b>	<b>14</b>
<b>9.MAINTENENCE AND REPAIR.....</b>	<b>14-16</b>
<b>10. TRANSPORTATION AND STORAGE.....</b>	<b>17</b>
<b>11.OPENING AND CHECKING.....</b>	<b>17</b>
<b>12.QUALITY ASSUARANCE.....</b>	<b>17-19</b>
<b>FIGURES.....</b>	<b>20</b>