

Trademarks

Autel®, MaxiSys®, MaxiDAS®, MaxiScan®, MaxiTPMS®, MaxiRecorder®, and MaxiCheck® are trademarks of Autel Intelligent Technology Corp., Ltd., registered in China, the United States and other countries. All other marks are trademarks or registered trademarks of their respective holders.

Copyright Information

No part of this manual may be reproduced, stored in a retrieval system or transmitted, in any form or by any means, electronic, mechanical, photocopying, recording, or otherwise without the prior written permission of Autel.

Disclaimer of Warranties and Limitation of Liabilities

All information, specifications and illustrations in this manual are based on the latest information available at the time of printing.

Autel reserves the right to make changes at any time without notice. While information of this manual has been carefully checked for accuracy, no guarantee is given for the completeness and correctness of the contents, including but not limited to the product specifications, functions, and illustrations.

Autel will not be liable for any direct, special, incidental, indirect damages or any economic consequential damages (including lost profits).

IMPORTANT

Before operating or maintaining this unit, please read this manual carefully, paying extra attention to the safety warnings and precautions.

For Services and Support:



pro.autel.com
www.autel.com



1-855-288-3587/1-855-AUTELUS (North America)
0086-755-86147779 (China)



support@autel.com

For details, please refer to the [Service Procedures](#) in this manual.

Safety Information

For your own safety and the safety of others, and to prevent damage to the device and vehicles upon which it is used, it is important that the safety instructions presented throughout this manual be read and understood by all persons operating or coming into contact with the device.

There are various procedures, techniques, tools, and parts for servicing vehicles, as well as in the skill of the person doing the work. Because of the vast number of test applications and variations in the products that can be tested with this equipment, we cannot possibly anticipate or provide advice or safety messages to cover every circumstance. It is the automotive technician's responsibility to be knowledgeable of the system being tested. It is crucial to use proper service methods and test procedures. It is essential to perform tests in an appropriate and acceptable manner that does not endanger your safety, the safety of others in the work area, the device being used, or the vehicle being tested.

Before using the device, always refer to and follow the safety messages and applicable test procedures provided by the manufacturer of the vehicle or equipment being tested. Use the device only as described in this manual. Read, understand, and follow all safety messages and instructions in this manual.

Safety Messages

Safety messages are provided to help prevent personal injury and equipment damage. All safety messages are introduced by a signal word indicating the hazard level.

DANGER

Indicates an imminently hazardous situation which, if not avoided, will result in death or serious injury to the operator or to bystanders.

WARNING

Indicates a potentially hazardous situation which, if not avoided, could result in death or serious injury to the operator or to bystanders.

Safety Instructions

The safety messages herein cover situations Autel is aware of. Autel cannot know, evaluate or advise you in regards of all possible hazards. You must be certain that any condition or service procedure encountered does not jeopardize your personal safety.

 **DANGER**

When an engine is operating, keep the service area WELL VENTILATED or attach a building exhaust removal system to the engine exhaust system. Engines produce carbon monoxide, an odorless, poisonous gas that causes slower reaction time and can lead to serious personal injury or loss of life.

 **It is not advised to use headphones at a high volume**

Listening at high volumes for long periods of time may result in loss of hearing.

 **Safety Warnings**

- Always perform automotive testing in a safe environment.
- Wear safety eye protection that meets ANSI standards.
- Keep clothing, hair, hands, tools, test equipment, etc., away from all moving or hot engine parts.
- Operate the vehicle in a well-ventilated work area.
- Put the transmission in PARK (for automatic transmission) or NEUTRAL (for manual transmission) and make sure the parking brake is engaged.
- Put blocks in front of the drive wheels and never leave the vehicle unattended while testing.
- Be extra cautious when working around the ignition coil, distributor cap, ignition wires and spark plugs. These components create hazardous voltages when the engine is running.
- Keep a fire extinguisher suitable for gasoline, chemical, and electrical fires nearby.
- Do not connect or disconnect any test equipment while the ignition is on or the engine is running.
- Keep the test equipment dry, clean, and free from oil, water and grease. Use a mild detergent on a clean cloth to clean the outside of the equipment as necessary.
- Do not drive the vehicle and operate the test equipment at the same time. Any distraction may cause an accident.
- Refer to the service manual for the vehicle being serviced and adhere to all diagnostic procedures and precautions. Failure to do so may result in personal injury or damage to the test equipment.
- To avoid damaging the test equipment or generating false data, make sure the vehicle battery is fully charged and the connection to the vehicle DLC is clean and secure.
- Do not place the test equipment on the distributor of the vehicle. Strong electro-magnetic interference can damage the equipment.

CONTENTS

SAFETY INFORMATION	ii
SAFETY INSTRUCTIONS	ii
1. USING THIS MANUAL	1
1.1 CONVENTIONS	1
2. GENERAL INTRODUCTION	3
2.1 MAXISYS TABLET	3
2.2 MAXIFLASH VCI	7
2.3 ACCESSORY KIT	9
3. GETTING STARTED	12
3.1 POWER UP	12
3.2 POWER DOWN	15
4. DIAGNOSTICS	17
4.1 ESTABLISH VEHICLE COMMUNICATION AND SELECTION	17
4.2 NAVIGATION	27
4.3 AUTO SCAN	31
4.4 CONTROL UNIT	34
4.5 ECU INFORMATION	35
4.6 TROUBLE CODES	36
4.7 LIVE DATA	37
4.8 ACTIVE TEST	44
4.9 SPECIAL FUNCTIONS	45
4.10 PROGRAMMING AND CODING	45
4.11 GENERIC OBDII OPERATIONS	47
4.12 DIAGNOSTIC REPORT	51
4.13 EXIT DIAGNOSTICS	56
5. INTELLIGENT DIAGNOSTICS	58
5.1 ACCESSING INTELLIGENT DIAGNOSTICS FUNCTION	58
5.2 INTELLIGENT DIAGNOSTICS OPERATION	64
6. SERVICE	72
6.1 OIL RESET SERVICE	72
6.2 ELECTRIC PARKING BRAKE (EPB) SERVICE	73
6.3 TIRE PRESSURE MONITORING SYSTEM (TPMS) SERVICE	73
6.4 BATTERY MANAGEMENT SYSTEM (BMS) SERVICE	73
6.5 DIESEL PARTICLE FILTER (DPF) SERVICE	74

6.6	IMMOBILIZER (IMMO) SERVICE.....	75
6.7	STEERING ANGLE SENSOR (SAS) SERVICE.....	75
7.	ADAS.....	77
8.	DATA MANAGER.....	78
8.1	VEHICLE HISTORY.....	79
8.2	WORKSHOP INFORMATION.....	81
8.3	CUSTOMER.....	81
8.4	IMAGE.....	82
8.5	REPORT.....	84
8.6	PDF FILES.....	84
8.7	REVIEW DATA.....	84
8.8	UNINSTALL APPS.....	85
8.9	DATA LOGGING.....	85
9.	BATTERY TEST.....	86
9.1	MAXIBAS BT506 TESTER.....	86
9.2	TEST PREPARATION.....	88
9.3	IN-VEHICLE TEST.....	89
9.4	OUT-VEHICLE TEST.....	94
10.	SETTINGS.....	97
10.1	OPERATIONS.....	97
11.	UPDATE.....	102
12.	VCI MANAGER.....	104
12.1	WI-FI CONNECTION.....	104
12.2	VCI BLUETOOTH PAIRING.....	106
12.3	BAS BLUETOOTH PAIRING.....	107
12.4	VCI UPDATE.....	107
12.5	BAS UPDATE.....	108
13.	SUPPORT.....	110
13.1	PRODUCT REGISTRATION.....	110
13.2	SUPPORT SCREEN LAYOUT.....	111
13.3	MY ACCOUNT.....	112
13.4	DATA LOGGING.....	113
13.5	TRAINING.....	113
13.6	FAQ.....	114
14.	OEM AUTHORIZATION.....	115

15. MAXVIEWER.....	117
16. MAXIVIDEO.....	118
17. QUICK LINK	119
18. REMOTE DESKTOP	120
18.1 OPERATIONS	120
19. USER FEEDBACK	122
20. MAINTENANCE AND SERVICE	123
20.1 MAINTENANCE INSTRUCTIONS.....	123
20.2 TROUBLESHOOTING CHECKLIST.....	123
20.3 ABOUT BATTERY USAGE	124
20.4 SERVICE PROCEDURES.....	125
21. COMPLIANCE INFORMATION.....	128
22. WARRANTY	129
22.1 12-MONTH LIMITED WARRANTY.....	129

1. Using This Manual

This manual contains device usage instructions.

Some illustrations shown in this manual may contain modules and optional equipment that are not included in your system.

1.1 Conventions

The following conventions are used:

1.1.1 Bold Text

Bold text is used to highlight selectable items such as buttons and menu options.

Example:

- Tap **OK**.

1.1.2 Notes and Important Messages

Notes

A **NOTE** provides helpful information such as additional explanations, tips, and comments.

Important

IMPORTANT indicates a situation that if not avoided may result in damage to the tablet or vehicle.

1.1.3 Hyperlink

Hyperlinks or links that take you to other related articles, procedures, and illustrations are available in electronic documents. Blue text indicates a selectable hyperlink, a website link or an email address link.

1.1.4 Illustrations

Illustrations used in this manual are samples, and the actual testing screen may vary for each vehicle being tested. Observe the menu titles and on-screen instructions to make correct option selection.

1.1.5 Procedures

An arrow icon indicates a procedure.

Example:

➤ **To use the camera**

1. Tap the **Camera** icon. The camera screen opens.
2. Focus the image to be captured in the viewfinder.
3. Tap the camera icon on the right side of the screen. The viewfinder now shows the captured picture and auto-saves the taken photo.
4. Tap the thumbnail image on the top-right corner of the screen to view the stored image.
5. Tap the **Back** or **Home** button to exit the camera application.

2. General Introduction

MaxiSys MS909 is a multi-platform diagnostics solution comprised of a powerful 9.7-inch TFT-LCD touchscreen Android-based tablet, a VCI communication and diagnostics unit, and an on-tool and cloud-based repair instructions and expert advice. As an intelligent diagnostics and information system, MaxiSys MS909 not only displays the relevant repairs gathered from experienced industry experts, but also provides step-by-step guidance to ensure the repair is done correctly and efficiently.

There are two main components to the MaxiSys system:

- MaxiSys Tablet — the central processor and monitor for the system.
- MaxiFlash VCI — Vehicle Communication Interface.

This manual describes the construction and operation of these devices and how they work together to deliver diagnostic solutions.

2.1 MaxiSys Tablet

2.1.1 Function Description

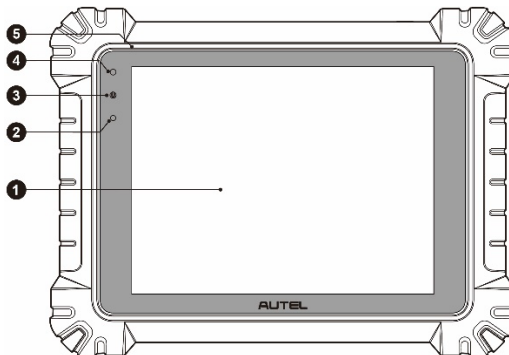

Figure 2-1 MaxiSys Tablet, Front View

1. 9.7" TFT-LCD Capacitive Touchscreen
2. Ambient Light Sensor — detects ambient light brightness
3. Power LED — refer to [Table 2-1 Power LED Description](#) for details
4. Front Camera
5. Built-in Microphone

Table 2-1 Power LED Description

LED	Color	Description
Power	Green	<ul style="list-style-type: none"> Lights solid green when the tablet is charging and the battery level is above or equal to 90%. Lights solid green when the tablet is powered on and the battery level is above or equal to 15%.
	Yellow	Lights solid yellow when the tablet is charging and the battery level is below 90%.
	Red	Lights solid red when the tablet is powered on and the battery level is below 15%.

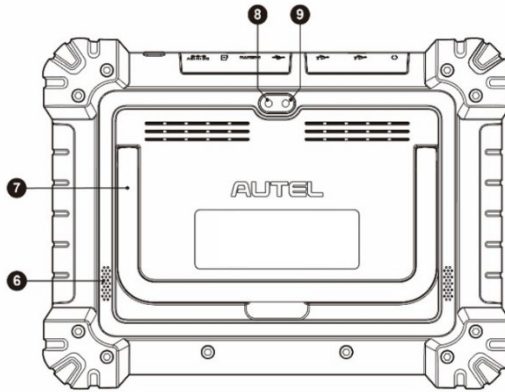

Figure 2-2 MaxiSys Tablet, Back View

- 6. Speaker
- 7. Collapsible Stand — extends from the back to allow hands-free viewing of the tablet
- 8. Rear Camera
- 9. Camera Flash

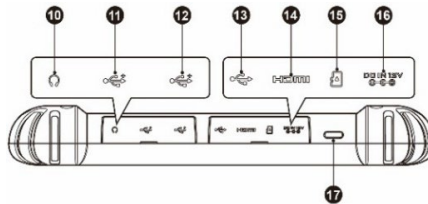

Figure 2-3 MaxiSys Tablet, Top View

- 10. Headphone Jack

11. USB Port
12. USB Port
13. Mini USB Port
14. HDMI (High-Definition Multimedia Interface) Port
15. Micro SD Card Slot
16. DC Power Supply Input Port
17. Power/Lock Button — long press to turn the tablet on and off, or tap to lock the screen

2.1.2 Power Sources

The tablet can receive power from any of the following sources:

- Internal battery pack
- AC/DC power supply
- Vehicle power

! IMPORTANT

Do not charge the battery when the temperature is below 0 °C (32 °F) or above 45 °C (113 °F).

Internal Battery Pack

The tablet can be powered with its internal rechargeable battery pack, which if fully charged can provide sufficient power for about 8 hours of continuous operation.

AC/DC Power Supply

The tablet can be powered from an electrical outlet using the AC/DC power adapter. The AC/DC power supply also charges the internal battery pack.

Vehicle Power

The tablet can be powered from the auxiliary power outlet adapter or other suitable power port on the test vehicle through a direct cable connection. The vehicle power cable connects to the DC power supply port on the top side of the tablet.

2.1.3 Technical Specifications

Table 2-2 Tablet Specifications

Item	Description
Operating System	Android 10.0

Item	Description
Processor	Octa-core processor (Qualcomm Kryo 260 CPU) (4 x 2.2 GHz + 4 x 1.8 GHz)
Memory	4 GB RAM & 128 GB on-board memory
Display	9.7-inch TFT-LCD capacitive touchscreen with 1536 x 2048 resolution
Connectivity	<ul style="list-style-type: none"> ● Wi-Fi x 2 (802.11 a/b/g/n/ac 2x2 MIMO) ● BT V5.0 + BR/EDR ● GPS ● USB 2.0 (two USB host type A, one mini USB device) ● HDMI 2.0 ● SD card (supports up to 256 GB)
Camera	<ul style="list-style-type: none"> ● Rear: 16 megapixel, autofocus with flashlight ● Front: 16 megapixel
Sensors	Gravity accelerometer, ambient light sensor (ALS)
Audio Input / Output	<ul style="list-style-type: none"> ● Microphone ● Dual speakers ● 3-band 3.5 mm stereo/standard headset jack
Power and Battery	<ul style="list-style-type: none"> ● 15000 mAh 3.8 V lithium-polymer battery ● Charging via 12 V AC/DC power supply with a temperature between 0 °C and 45 °C
Input Voltage	12 V/3 A adapter
Operating Temp.	0 to 50 °C (32 to 122 °F)
Storage Temp.	-20 to 60 °C (-4 to 140 °F)
Dimensions (W x H x D)	304.4 mm (11.98") x 227.8 mm (8.97") x 42.5 mm (1.67")
Weight	1.66 kg (3.66 lb.)

Item	Description
<p>Protocols</p>	<p>DoIP, PLC J2497, ISO-15765, SAE-J1939, ISO-14229 UDS, SAE-J2411 Single Wire Can(GMLAN), ISO-11898-2, ISO-11898-3, SAE-J2819 (TP20), TP16, ISO-9141, ISO-14230, SAE-J2610 (Chrysler SCI), UART Echo Byte, SAE-J2809 (Honda Diag-H), SAE-J2740 (GM ALDL), SAE-J1567 (CCD BUS), Ford UBP, Nissan DDL UART with Clock, BMW DS2, BMW DS1, SAE J2819 (VAG KW81), KW82, SAE J1708, SAE-J1850 PWM (Ford SCP), SAE-J1850 VPW (GM Class2)</p>

2.2 MaxiFlash VCI

2.2.1 Function Description

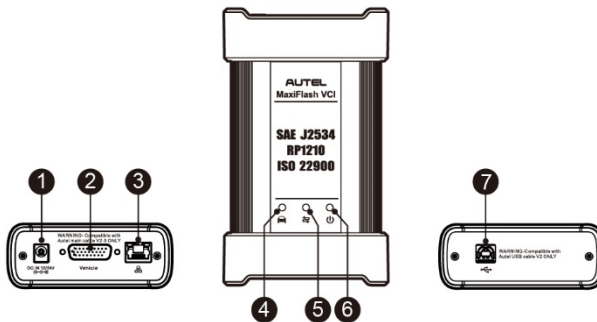

Figure 2-4 MaxiFlash VCI

1. DC Power Supply Input Port
2. Vehicle Data Connector
3. Ethernet Port
4. Vehicle LED
 - Flashes green when the device is communicating with the vehicle system
5. Connection LED
 - Lights solid green when connected with the tablet via the USB cable
 - Lights solid cyan (blue/green) when connected via Wi-Fi
 - Lights solid blue when connected via Bluetooth

6. Power LED

- Lights solid green when powered on
- Flashes red when VCI is upgrading
- Lights solid red when system failure has occurred
- Lights solid yellow automatically at power up when VCI is self-testing

7. USB Port

! IMPORTANT

DO NOT disconnect the MaxiFlash VCI while the vehicle LED status light is on. If the programming procedure is interrupted while the vehicle's ECU is blank or only partially programmed, the module may be unrecoverable.

Programming Capability

The MaxiFlash VCI is a D-PDU, SAE J2534 & RP1210 compliant PassThru programming interface. Using the updated OEM software, it is capable of replacing the existing software/firmware in the Electronic Control Units (ECU), programming new ECUs, and fixing software-controlled drivability issues and emission issues.

Communication Capability

The MaxiFlash VCI supports Bluetooth (BT), Wi-Fi, and USB communications. It can transmit vehicle data to the tablet with or without a cable connection. In open areas, the working range of the transmitter through Bluetooth communication is up to 328 feet (about 100 m). The working range of 5G Wi-Fi is up to 164 feet (50 m). If the signal is lost due to being taken out of range, communication will be restored once the tablet is within range.

2.2.2 Power Sources

The VCI can receive power from the following sources:

- Vehicle power
- AC/DC power supply

Vehicle Power

The VCI operates on 12/24 Volt vehicle power, which receives power via the vehicle data connection port. The device powers on whenever it is connected to an OBDII/EOBD compliant Data Link Connector (DLC). For non-OBDII/EOBD compliant vehicles, the device can be powered from an auxiliary power outlet on the test vehicle using the auxiliary power cable.

AC/DC Power Supply

The VCI can be powered from a wall socket using the AC/DC power adapter.

2.2.3 Technical Specifications

Table 2-3 *MaxiFlash VCI Specifications*

Item	Description
Communications	<ul style="list-style-type: none">● BT V2.1 + EDR● USB 2.0● Wi-Fi 5G● Ethernet
Wireless Frequency	5 GHz
Input Voltage Range	12 VDC to 24 VDC
Supply Current	<ul style="list-style-type: none">● 170 mA @ 12 VDC● 100 mA @ 24 VDC
Operating Temp.	0 °C to 50 °C (32 to 122 °F)
Storage Temp.	-20 °C to 60 °C (-4 to 140 °F)
Dimensions (L x W x H)	149 mm (5.87") x 86 mm (3.38") x 35 mm (1.28")
Weight	0.29 kg (0.64 lb.)

2.3 Accessory Kit

2.3.1 Main Cable V2.0

The VCI can be powered through the Autel Main Cable V2.0 (the V2.0 icon can be seen on the cable) when connected to an OBDII/EOBD compliant vehicle. The Main Cable connects the VCI to the vehicle's Data Link Connector (DLC), through which the VCI can transmit vehicle data to the tablet.

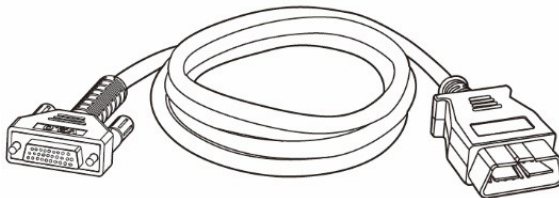

Figure 2-5 *Main Cable V2.0 — 1.5m in Length*

NOTE

The MaxiFlash VCI can be connected by the Autel Main Cable V2.0 only. DO NOT use other Autel main cables to connect the MaxiFlash VCI.

2.3.2 OBDI-Type Adapters (Optional)

The optional OBDI-type adapters are for Non-OBDII vehicles. The adapter used depends on the type of vehicle being tested. These adapters are sold separately. Please contact your distributor for details.

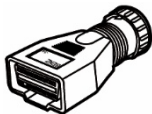

Benz-14



Chrysler-16



BMW-20



Nissan-14



Kia-20



Fiat-3



PSA-2



Mazda-17



Volkswagen/
Audi-2+2



Benz-38



Mitsubishi/
Hyundai-12+16

2.3.3 Other Accessories

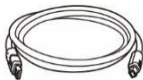

Autel USB Cable V2 (the V2 icon can be seen on the cable)
Connects the tablet to the VCI.



AC/DC External Power Adapter
Connects the tablet to the external DC power port for power supply.



Auxiliary Power Outlet Adapter
Provides power to the tablet or the VCI through connection to the vehicle's auxiliary power outlet, as some non-OBDII vehicles cannot provide power via the DLC connection.



Clamp Cable

Provides power to the tablet or the VCI through connection to the vehicle battery.

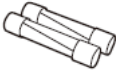

Light Fuse x2

A safety device for the auxiliary power outlet adapter.

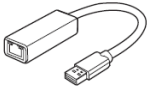

USB to Ethernet Adapter

Provides network connection function.

3. Getting Started

Make sure the tablet has sufficient power or is connected to the external power supply (see [Power Sources](#)).

NOTE

The images and illustrations depicted in this manual may differ from the actual ones.

3.1 Power Up

Long press the **Power/Lock** button on the top right side of the tablet to switch on the unit. The system boots up and shows the lock screen. Slide the Lock icon up to unlock and enter the MaxiSys Job Menu.



Figure 3-1 MaxiSys Job Menu Screen

1. Application Buttons
2. Page Control and Navigation Buttons
3. System Status Icons

NOTE











It is recommended that you lock the screen when not in use to protect information in the system and conserve the power.





Almost all operations on the tablet are controlled through the touchscreen. The touchscreen navigation is menu-driven, which allows you to quickly locate the test procedure, or data that you need, through a series of questions and options. Detailed descriptions of the menu structures are found in the chapters for each application.

3.1.1 Application Buttons

The table below briefly describes each of the applications in the MaxiSys system.

Table 3-1 Applications







Button	Name	Description
	Diagnostics	Accesses the unit's diagnostic functions. See Diagnostics for details.
	Service	Accesses special functions menu. See Service for details.
	ADAS	Accesses ADAS systems menu. See ADAS for details.
	Data Manager	Accesses the saved repair shop, customer and vehicle data including detailed vehicle diagnostics and test records. See Data Manager for details.
	Battery Test	Accesses the Battery Test menu with in-vehicle test and out-vehicle test functions. See Battery Test for details.
	Settings	Accesses the system settings menu and general tablet menu. See Settings for details.
	Update	Accesses system software update menu. See Update for details.
	VCI Manager	Accesses VCI connection menu. See VCI Manager for details.
	Support	Synchronizes Autel's online service database with the MaxiSys tablet. See Support for details.
	OEM Authorization	Unlocks the gateway ECU (CGW) for some vehicles to perform advanced diagnostics tests. See OEM Authorization for details.
	MaxiViewer	Provides a quick search for supported functions and/or vehicles. See MaxiViewer for details.





Button	Name	Description
	MaxiVideo	Configures the unit to operate as a video scope device by connecting to an imager head cable for close vehicle inspections. See MaxiVideo for details.
	Quick Link	Provides associated website bookmarks to allow quick access to product update, service, support, and other information. See Quick Link for details.
	Remote Desktop	Configures your unit to receive remote support using the TeamViewer application. See Remote Desktop for details.
	User Feedback	Allows you to submit feedback related to this product. See User Feedback for details.
	Autel User Center	Allows you to register an Autel account, view and edit your personal profile, and link your device.

3.1.2 Page Control and Navigation Buttons

Operations of the page control and navigation buttons are described as below:

Table 3-2 Page Control and Navigation Buttons

Button	Name	Description
	Page Control	Indicates the location of the current screen. Swipe screen left or right to view previous or next screen.
	Back	Returns to the previous screen.
	MaxiSys Home	Returns to MaxiSys Job Menu.
	Android Home	Returns to the Android system home screen.
	Recent Apps	Displays a list of currently running applications. Tap an app icon to launch. To remove an app, swipe it to the left or right.
	Browser	Launches the browser.

Button	Name	Description
	Camera	Tap to launch the camera. Press and hold to capture a screenshot of the display screen. Saved files are stored in the Data Manager application for later review. See Data Manager for details.
	Display & Sound	Allows you to adjust the brightness of the screen and the volume of the audio output.
	VCI	Opens the VCI Manager application. A green Wi-Fi/BT/USB icon at the bottom-right corner indicates the VCI is connected via Wi-Fi/Bluetooth/USB cable, while a red “X” indicates no connection.
	MaxiSys Shortcut	Returns to the Diagnostics screen.
	Service Shortcut	Returns to the Service screen.

➤ **To use the camera**

1. Tap the **Camera** icon. The camera screen opens.
2. Focus the image to be captured in the viewfinder.
3. Tap the camera icon on the right side of the screen. The viewfinder now shows the captured picture and auto-saves the taken photo.
4. Tap the thumbnail image on the top-right corner of the screen to view the stored image.
5. Tap the **Back** or **Home** button to exit the camera application.

🔍 **NOTE**

After swiping the camera screen from left to right, the camera mode and video mode can be switched by tapping the blue camera icon or video icon.

3.1.3 System Status Icons

These are the standard status icons of the Android operating system. Your MaxiSys tablet is a fully functional Android Pad.

3.2 Power Down

All vehicle communications must be terminated before shutting down the tablet. A warning message appears if a shutdown is attempted while the tablet is communicating

with the vehicle. Forcing a shut down while the tablet is communicating may lead to ECU (Electronic Control Unit) problems on some vehicles. Please fully exit the Diagnostics application before shutting off the tablet.

➤ **To power down the MaxiSys tablet**

1. Press and hold the **Power/Lock** button.
2. Tap **Power Off**.
3. Tap **OK**.

3.2.1 Reboot System

In case of a system crash, long press the **Power/Lock** button and tap **Restart** to reboot the system.

4. Diagnostics

The Diagnostics application can access the electronic control module of multiple vehicle control systems, including but not limited to the engine, transmission, anti-lock brake system (ABS), and airbag system (SRS).

4.1 Establish Vehicle Communication and Selection

4.1.1 Establish Vehicle Communication

The Diagnostics operations require connecting the MaxiSys MS909 tablet to the test vehicle through the MaxiFlash VCI using the main cable V2.0 and test adapters (for non-OBDII vehicles). To establish proper vehicle communication to the tablet, you need to perform the following steps:

1. Connect the VCI to the vehicle's DLC for both communication and power source.
2. Connect the VCI to the tablet via Bluetooth pairing, Wi-Fi or USB connection.
3. Check the VCI navigation button at the bottom bar on the screen. If a green BT, Wi-Fi or USB icon displays at the lower-right corner, the MaxiSys MS909 Diagnostics Platform is ready to start vehicle diagnosis.

Vehicle Connection

The method used to connect the VCI to a vehicle's DLC depends on the vehicle's configuration as follows:

- A vehicle equipped with an On-board Diagnostics Two (OBDII) management system supplies both communication and 12-volt power through a standardized J-1962 DLC.
- A vehicle not equipped with an OBDII management system supplies communication through a DLC connection, and in some cases supplies 12-volt power through the auxiliary power outlet or a connection to the vehicle battery.

OBDII Vehicle Connection

This type of connection only requires the main cable V2.0 without any additional adapter.

➤ **To connect to an OBDII vehicle**

1. Connect the main cable's female adapter to the Vehicle Data Connector on the VCI and tighten the captive screws.
2. Connect the cable's 16-pin male adapter to the vehicle's DLC, which is generally located under the vehicle dashboard.

 **NOTE**

The vehicle's DLC is not always located under the dashboard. Refer to the user manual of the test vehicle for additional connection information.

Non-OBDII Vehicle Connection

This type of connection requires both the main cable V2.0 and a required OBDI adapter for the specific vehicle being serviced.

There are three possible conditions for Non-OBDII vehicle connection:

- DLC connection supplies both communication and power.
- DLC connection supplies communication and power is to be supplied via the vehicle's auxiliary power outlet.
- DLC connection supplies communication and power is to be supplied via connection to the vehicle battery.

➤ **To connect to a Non-OBDII Vehicle**

1. Connect the main cable's female adapter to the Vehicle Data Connector on the VCI and tighten the captive screws.
2. Locate the required OBDI adapter and connect its 16-pin jack to the main cable's male adapter.
3. Connect the attached OBDI adapter to the vehicle's DLC.

 **NOTE**

Some vehicles may have more than one adapter or may have test leads instead of an adapter. Whatever the case, make the proper connection to the vehicle's DLC as required.

➤ **To connect the auxiliary power outlet adapter**

1. Plug the DC power connector of the auxiliary power outlet adapter into the DC power supply input port on the device.
2. Connect the male connector of the auxiliary power outlet adapter into the vehicle's auxiliary power outlet.

➤ **To connect the clamp cable**

1. Connect the tubular plug of the clamp cable to the male connector of the auxiliary power outlet adapter.

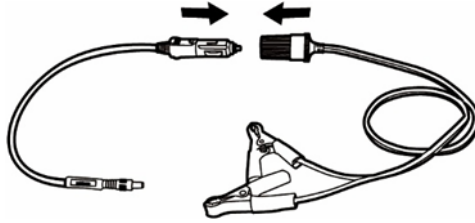

Figure 4-1 Connect Auxiliary Power Outlet Adapter to Clamp Cable

2. Plug the DC power connector of the auxiliary power outlet adapter into the DC power supply input port of the VCI.
3. Connect the clamp cable to the vehicle's battery.

NOTE

After the VCI is successfully connected to the vehicle, the Power LED on the device lights, and a brief beeping sound will be heard.

VCI Connection

After the VCI is properly connected to the vehicle, the Power LED on the VCI lights solid green, and is ready to establish communication with the tablet.

MaxiSys MS909 supports three communication methods: Bluetooth, Wi-Fi, and USB.

Bluetooth Connection

In open areas, the working range for Bluetooth communication is about 328 feet (100 m), giving technicians greater mobility to perform vehicle diagnosis from anywhere in the repair shop.

To expedite multi-vehicle diagnostics, more than one VCI can be used in busy repair shops enabling technicians to quickly pair (via Bluetooth) their diagnostic tablets to each VCI separately and therefore eliminating the need to physically connect the VCI to each vehicle.

➤ **To pair up the tablet with the VCI via Bluetooth**

1. Power up the tablet.
2. Select the **VCI Manager** application from the MaxiSys Job Menu.
3. Select **VCI BT** from the connection mode list. Tap the **Bluetooth** toggle to turn it **ON**. The device automatically scans for available VCIs for pairing. The found devices are listed on the right side of the screen.

NOTE

If no VCI is found, this may indicate that the signal strength is too weak to be detected. Reposition the VCI, and remove all possible objects that may cause signal interference. Tap the **Scan** button at the top-right corner to rescan for VCI.

4. Typically, the VCI name appears as “Maxi” suffixed with a serial number. Select the VCI for pairing. (If more than one VCI is used in the shop, ensure the correct VCI is selected to pair.)
5. When pairing is successful, the connection status reads, “Connected.”
6. The VCI icon on the tablet navigation bar in the bottom appears a green circle BT icon when the tablet and the VCI are connected.

Wi-Fi Connection

The VCI supports 5G Wi-Fi connection. In open areas, the working range of 5G Wi-Fi communication is up to 164 feet (50 m).

➤ To pair the tablet with the VCI via Wi-Fi

1. Power up the tablet.
2. Select the **VCI Manager** application from the MaxiSys Job Menu.
3. Select **Wi-Fi** from the connection mode list. Tap the **Wi-Fi** toggle to turn it **ON**. The device automatically scans for available VCIs for Wi-Fi connection. Found VCIs are listed on the right side of the screen.
4. Typically, the VCI name appears as “Maxi” suffixed with a serial number. Select the required VCI for connection.
5. When pairing is successful, the connection status reads, “Connected.”
6. The VCI icon on the tablet navigation bar at the bottom appears a green circle Wi-Fi icon when the tablet and the VCI are connected.

USB Cable Connection

The USB cable connection is a simple and stable way to establish communication between the tablet and the VCI. After properly connecting the USB cable from the tablet to the VCI, the VCI navigation button at the bottom bar of the screen displays a green circle USB icon and the connection LED on the VCI lights solid green, indicating the connection between the devices is successful.

🔍 NOTE

Because of its stable communication capabilities, USB cable connection is the recommended communication method between the tablet and VCI when operating ECU programming or coding.

The MaxiSys MS909 is now ready to perform vehicle diagnosis.

No Communication Message

- A. If the tablet is unable to connect to the VCI, an error message displays. An error message indicates the tablet is not communicating with the VCI. In this case, you need to do the following check-ups:

- Ensure the VCI is powered on.
 - When using the wireless connection, ensure the network is configured correctly and the proper device has been connected.
 - If the tablet loses communication abruptly during the diagnosis, ensure no objects are causing signal interference.
 - Ensure the VCI is properly positioned with the VCI front side up.
 - Move the tablet closer to the VCI. If using the wired connection, ensure the cable is securely attached to the VCI.
 - Ensure the communication LED is lit for the selected communication type: Bluetooth, Wi-Fi or USB.
- B. If the VCI is unable to establish a communication link, a message will display. Possible causes for the communication error include:
- The VCI is unable to establish a communication link with the vehicle.
 - A vehicle system has been selected for diagnosis that is not supported by the vehicle.
 - There is a loose connection.
 - There is a blown vehicle fuse.
 - The vehicle or the data cable has a wiring fault.
 - There is a circuit fault in the data cable or adapter.
 - The vehicle identification number is incorrectly entered.

4.1.2 Getting Started

Prior to first use of the Diagnostics application, ensure the VCI is properly connected to and is communicating with the tablet. See [VCI Connection](#).

Vehicle Menu Layout

When the VCI is properly connected to the vehicle and paired to the tablet, the platform is ready to start vehicle diagnosis. Tap the **Diagnostics** application on the MaxiSys Job Menu, the Vehicle Menu displays on the screen.









Figure 4-2 Vehicle Menu Screen





1. Top Toolbar Buttons
2. Automobile Manufacturer Icons

Top toolbar Buttons

The operations of the ToolBAR buttons at the top of the screen are listed and described in the table below:

Table 4-1 Top Toolbar Buttons

Button	Name	Description
	Home	Returns to the MaxiSys Job Menu.
	VID	Opens a dropdown list. <ul style="list-style-type: none"> ● Tap Auto Detect for auto VIN detection. ● Tap Manual Input to enter VIN or license number manually. ● Tap Scan VIN/License to scan the VIN/license number by camera.
	All	Displays all vehicle makes in the vehicle menu.
	Favorites	Displays user-selected favorite vehicle makes.
	History	Displays stored test vehicle records. This option provides direct access to previously tested vehicle records. See Vehicle History for details.
	USA	Displays the American vehicle menu.

Button	Name	Description
	European	Displays the European vehicle menu.
	Asia	Displays the Asian vehicle menu.
	China	Displays the Chinese vehicle menu.
	Search	Tap the search field to display a virtual keyboard and enter the vehicle manufacturer to test.
	Cancel	Exits the search screen or cancel an operation.

Automobile Manufacturer Icons

The Automobile Manufacturer icons display the various vehicle logos and the brands. Select an automobile manufacturer icon after the VCI is properly connected to the test vehicle to start a diagnostics session.

4.1.3 Vehicle Identification

The MaxiSys diagnostics system supports four methods of Vehicle Identification.

1. Auto VIN Scan
2. Manual Input
3. Scan VIN/License
4. Manual Vehicle Selection

Auto VIN Scan

The MaxiSys diagnostics system features the latest VIN-based Auto VIN Scan function to identify test vehicles with just one tap, enabling the technician to quickly identify the exact vehicle and scan its available systems for fault codes.

➤ **To perform an Auto VIN Scan**

1. Tap the **Diagnostics** application button from the MaxiSys Job Menu. The Vehicle Menu appears.
2. Tap the **VID** button on the top toolbar.
3. Select **Auto Detect**. The tablet starts VIN scanning on the vehicle's ECU. Once the test vehicle is successfully identified, the system will guide you to the Diagnostics screen.

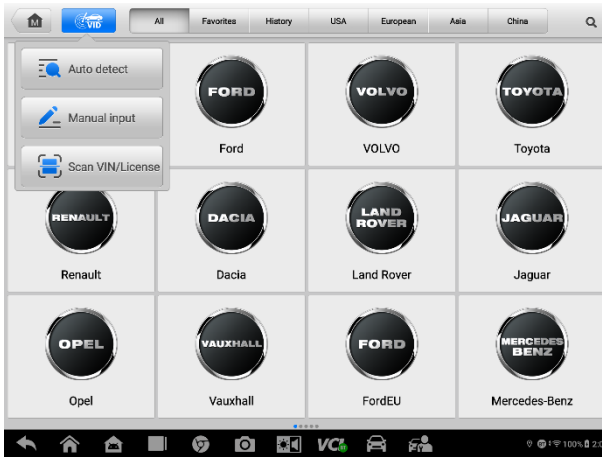

Figure 4-3 Auto Detect Screen

In some cases, the Auto VIN function is still available for some vehicle makes after being selected.

Select an automobile manufacturer icon from the Vehicle Menu screen (Figure 4-2) and then tap **Automatic Selection** > **Read**. The system will proceed to acquire VIN information automatically or allow users to manually enter the VIN.

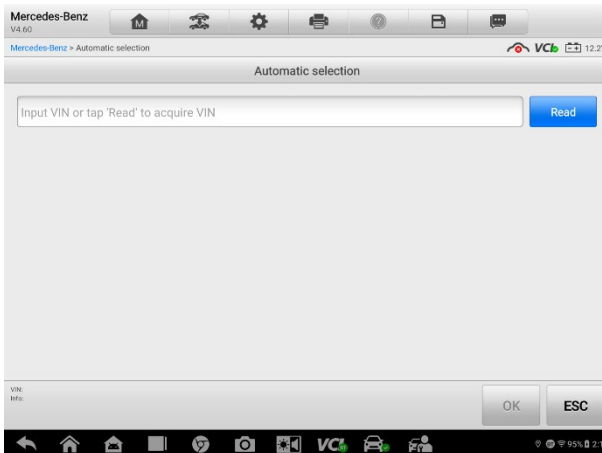

Figure 4-4 Automatic Selection Screen

Manual Input

For vehicles that do not support the Auto VIN Scan function, the MaxiSys diagnostics system allows you to enter the vehicle VIN or license number manually, or simply take a photo of the VIN sticker or license plate for quick vehicle identification.

➤ **To perform Manual VIN Input**

1. Tap the **Diagnostics** application button from the MaxiSys Job Menu. The Vehicle Menu appears.
2. Tap the **VID** button on the top toolbar.
3. Select **Manual Input** in the dropdown list (Figure 4-3).
4. Tap the input box and enter the correct VIN code or license number.

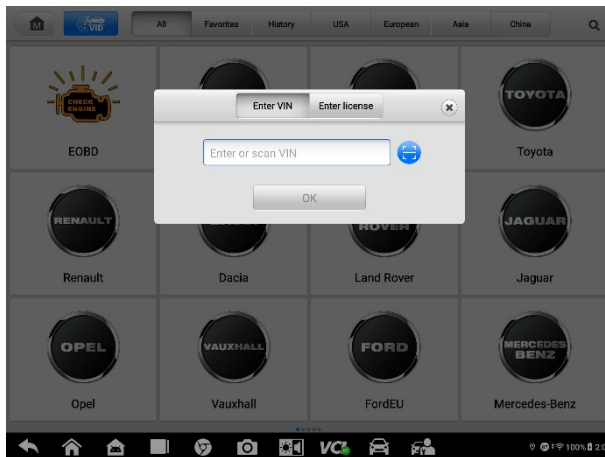

Figure 4-5 Manual VIN Input Screen

5. Tap **OK**. The vehicle will be identified and matched to the vehicle database and the Vehicle Diagnostics screen will display.
6. Tap “**x**” on the top-right corner to exit Manual Input.

Scan VIN/License

Tap **Scan VIN/License** in the dropdown list (Figure 4-3), the camera will launch. On the right side of the screen, from top to bottom, three options are available: **Scan Bar Code**, **Scan VIN**, and **Scan License**.

NOTE

The Scan License option is supported in certain countries and areas. If not available, manually enter the license number.

Select one of the three options and position the tablet to align the VIN or license number within the scanning window, the result appears in the Recognition Result dialog box after scanning. Tap **OK** to confirm the result, and then the vehicle information confirmation screen will appear on the tablet. If all vehicle information is correct, tap the icon on the middle of the screen to confirm the VIN of the test vehicle. Tap **OK** to continue.

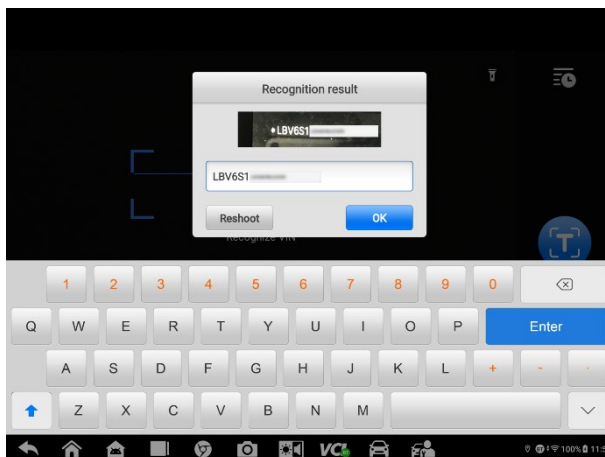



Figure 4-6 Scan VIN Code Screen 1

If the VIN/License number cannot be scanned, manually enter it after tapping the pen-shape  icon. Tap **OK** to continue. Manually enter the license number and select a vehicle brand in the vehicle information confirmation screen. Tap the icon in the middle of the screen to confirm the VIN of the vehicle being tested. Tap **OK** to continue.

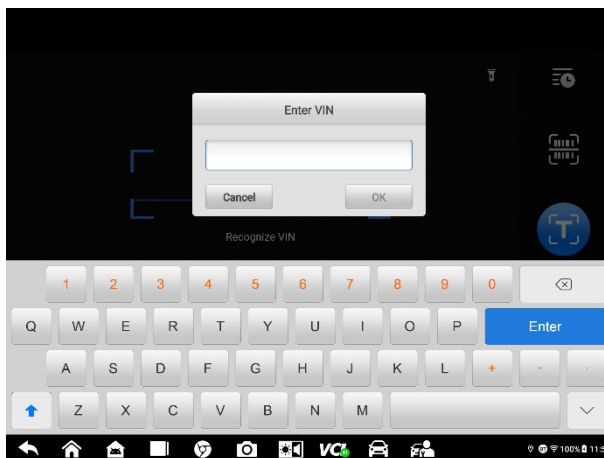

Figure 4-7 Scan VIN Code Screen 2

Manual Vehicle Selection

When the vehicle's VIN is not automatically retrievable through the vehicle's ECU, or when the specific VIN is unknown, you can choose to select the vehicle manually.

Step-by-step Vehicle Selection

This mode of vehicle selection is menu-driven. Select an automobile manufacturer icon on the Vehicle Menu screen (Figure 4-2) and the "Select Diagnostic Type" screen

appears. Tap the **Manual Selection** button. Select the vehicle information (e.g., the brand, model, capacity, engine type, and model year) on the same screen. Tap **Reset** or **ESC** to reselect the vehicle information, if needed.

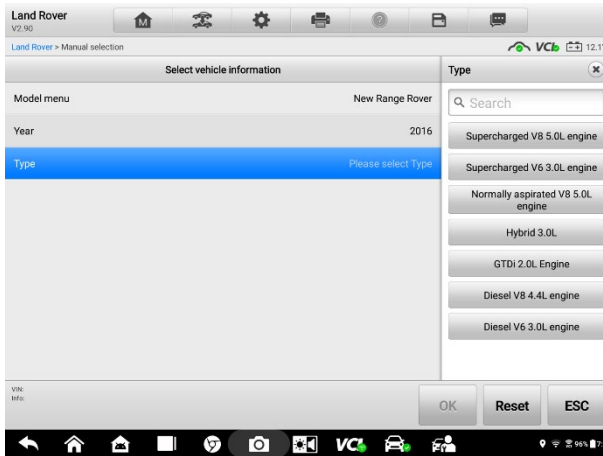

Figure 4-8 Manual Vehicle Selection Screen

4.2 Navigation

4.2.1 Diagnostics Screen Layout

After the vehicle information is selected, tap the **OK** button at the bottom-right corner of the screen (Figure 4-9) to open the Main Menu screen. This section consists of various functions commonly used, including Auto Scan, Control Unit, Service, Hot Functions, Programming, and more. The functions displayed vary by vehicle.

The diagnostics screens typically include five sections.

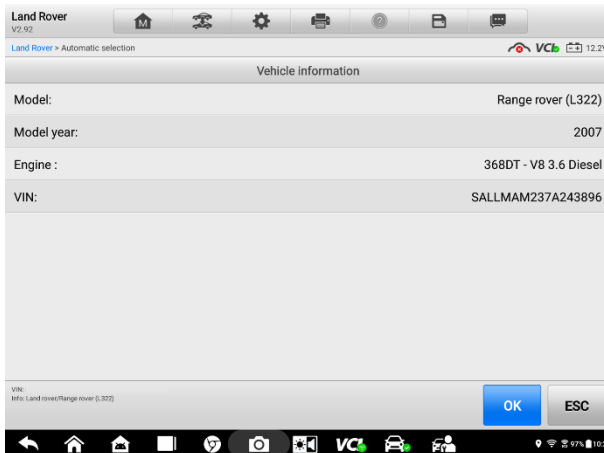

Figure 4-9 Vehicle Information Selection Screen

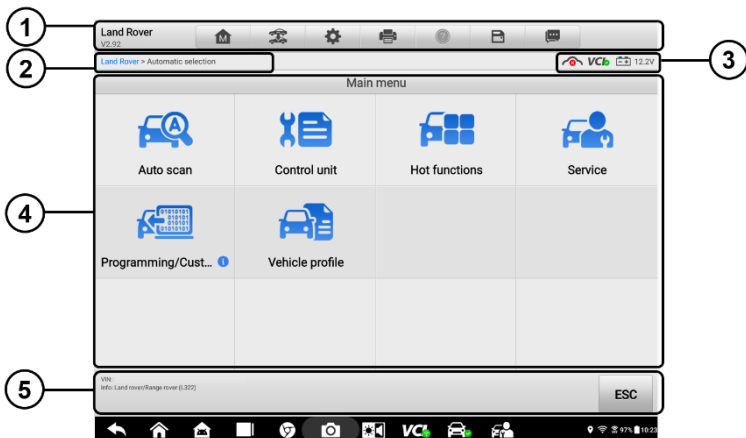







Figure 4-10 Main Menu Screen



1. Diagnostics Toolbar
2. Current Directory Path
3. Status Information Bar
4. Main Section
5. Function Buttons

Diagnostics Toolbar

The Diagnostics Toolbar contains buttons that allow you to print or save the displayed data and perform other operations. Table 4-2 provides a brief description for the operations of the diagnostics toolbar buttons.

Table 4-2 Diagnostics Toolbar Buttons

Button	Name	Description
	Home	Returns to the MaxiSys Job Menu.
	Vehicle Swap	Exits the diagnostics session and returns to the vehicle menu screen to select another vehicle for testing.
	Settings	Opens the Settings screen. See Settings for details.
	Print	Saves and prints a copy of the displayed data. See Printing Settings for details.
	Help	Provides instructions or tips for operations of various diagnostics functions.

Button	Name	Description
	Save	<p>There are three ways to save data:</p> <ul style="list-style-type: none"> • Tap Take a Screenshot to save an image of the current screen. • Tap Save All Data to save a PDF file (use this option when data displays on multiple screens). • Tap Save Report to connect the diagnostics information with the vehicle. <p>These files are stored in Data Manager application for later review. See Data Manager for details.</p>
	Data Logging	<p>Records the communication data and ECU information of the vehicle. The saved data can be reported and sent to the technical center via the Internet.</p> <p>You can go to the Support application to follow up the processing progress. See Data Logging for details.</p>

NOTE

The Diagnostics Toolbar buttons (located on the top of the screen) will be active throughout the diagnostics session for such tasks as printing and saving the displayed data, obtaining help information or performing data logging.

➤ To print data in Diagnostics

1. Tap the **Diagnostics** application button on the MaxiSys Job Menu. The **Print** button in the diagnostic toolbar is available throughout all diagnostics operations.
 2. Tap **Print** and a drop-down menu displays.
 - Print This Page** — prints a screenshot copy of the current screen.
 - Print All Data** — prints a PDF copy of all displayed data.
 3. A temporary file will be created and sent via the computer to the printer.
 4. When the file is sent, a confirmation message displays.
-

NOTE

Make sure the tablet and the printer are connected either by Wi-Fi or LAN before printing. For more instructions on printing, see [Printing Settings](#) for details.

➤ To submit Data Logging reports in Diagnostics

1. Tap the **Diagnostics** application button from the MaxiSys Main Screen. The **Data Logging** button on the diagnostics toolbar is available throughout all diagnostics operations.
2. Tap the **Data Logging** button to display the error options. Select a specific error

and tap **OK**. A submission form will display to let you fill in the report information.

3. Tap **Send** to submit the report form via the Internet. A confirmation message displays when sending is successful.

Current Directory Path

The Directory Path shows all directory names to access the current page.

Status Information Bar

The Status Information Bar at the top of the Main Section displays the following items:

1. **Network Icon** — indicates whether a network is connected.
2. **VCI Icon** — indicates the communication status between the tablet and the VCI.
3. **Battery Icon** — indicates the battery status of the vehicle.

Main Section

The Main Section of the screen varies depending on the stage of operations. The Main Section can show vehicle identification selections, the main menu, test data, messages, instructions, and other diagnostics information.

Function Buttons

The Function Buttons vary depending on the stage of operations. They can be used to navigate, save or clear the diagnostic data, exit scanning as well as make other function controls. The functions of these buttons will be described in the following sections when relevant.

4.2.2 Screen Messages

Messages display when additional input is needed before proceeding. There are mainly three types of on-screen messages as to their purposes: Confirmation, Warning, and Error.

● **Confirmation Messages**

These usually appear as an “Information” screen, which informs you when you are about to perform an action that cannot be reversed or when an action has been initiated and your confirmation is needed to continue.

When a user-response is not required to continue, the message appears briefly.

● **Warning Messages**

These appear when completing the selected action may result in an irreversible change or loss of data. The typical example for this is the “Erase Codes” message.

NOTE

On the Auto Scan screen, there is a Select System icon (📄) on the upper-right corner. Select the corresponding system(s) to scan, saving more time than scanning all systems.

4. The results are displayed on the screen.

4.3.1 Auto Scan Results

A. Topology Screen

The Topology screen displays the system distribution diagram of the vehicle control modules. After performing an auto scan, the results are displayed in different colors. The number of total faults will appear on the upper-right corner.

Green: No faults detected.

Gray: No response.

Blue: Not scanned.

Orange: Faults detected. The number of faults appears on the upper-right corner of the system.

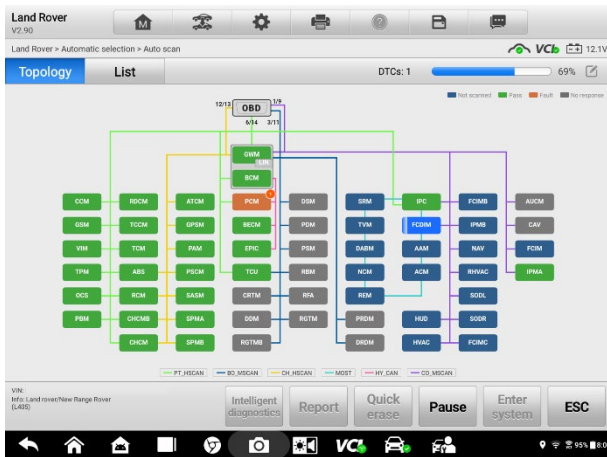

Figure 4-12 Topology Screen

B. List Screen

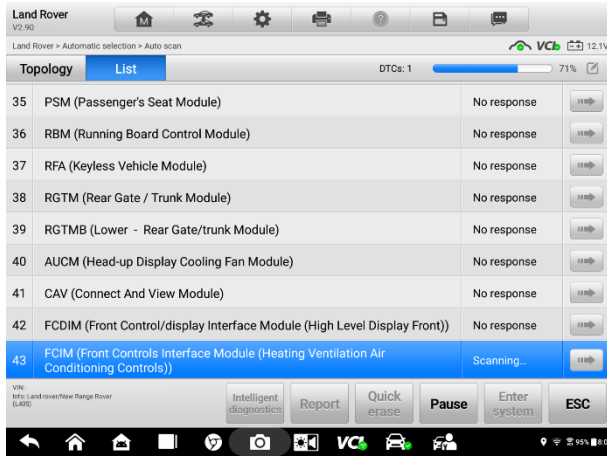



Figure 4-13 List Screen

Column 1 — displays the system numbers.

Column 2 — displays the scanned systems.

Column 3 — displays the scan results.

- ❖ **-?-**: Indicates that the vehicle control system has been detected, but the tablet cannot access it.
- ❖ **Fault | #**: Indicates there is/are fault code(s) present; “#” indicates the quantity of detected faults.
- ❖ **Pass | No Fault**: Indicates the system was scanned and no fault has been detected.
- ❖ **Not Scanned**: Indicates the system has not been scanned.
- ❖ **No Response**: Indicates the system has not received a response.

Column 4 — tap the  button to the right of the system item to perform further diagnosis and other test activities.

The table 4-3 provides a brief description of how the function buttons in Auto Scan operate:

Table 4-3 Function Buttons in Auto Scan

Name	Description
Intelligent Diagnostics	Directly accesses the Intelligent Diagnostics function to view the fault code analysis information. See Intelligent Diagnostics Operation for details.
Report	Displays the diagnostic data in the report form.

Name	Description
Quick Erase	Erases all faults after scanning.
Fault Scan	Scans vehicle system modules.
Pause	Pauses the scanning process.
Enter System	Enters the ECU system.
ESC	Returns to the previous screen or exits the Diagnostics screen.

Select one of the system modules from the Topology or List screen and tap **Enter System** to enter the specific system functions.

4.4 Control Unit

This option allows you to manually locate a required control system for testing through a series of choices. Follow the menu-driven procedure, the program will guide you to the Function Menu screen.

Available functions may vary by vehicle. The function menu may include:

- **ECU Information** — provides the retrieved ECU information in detail. Select it to open an information screen.
 - **Trouble Codes** — contains Read Codes and Erase Codes. The former displays detailed DTC information retrieved from the vehicle control module, the latter allows you to erase DTCs and other data from the ECU.
 - **Live Data** — retrieves and displays live data and parameters from the vehicle's ECU.
 - **Active Test** — provides specific subsystem and component tests. This selection may appear as *Actuators*, *Actuator Test* or *Function Tests*. Available tests vary by vehicle.
 - **Special Functions** — performs various component adaptations.
- **To perform an diagnostics function**
1. Establish communication with the test vehicle via the VCI.
 2. Identify the test vehicle by selecting from the menu options.
 3. Locate the required system for testing by **Auto Scan** or through menu-driven selections in **Control Unit**.
 4. Select the desired test from the Function menu.

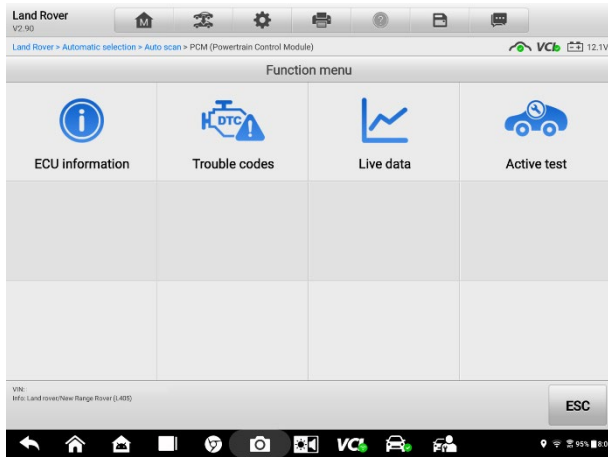

Figure 4-14 Function Menu Screen

4.5 ECU Information

This function retrieves and displays the specific information for the tested control unit, including unit type, version numbers, and other specifications.

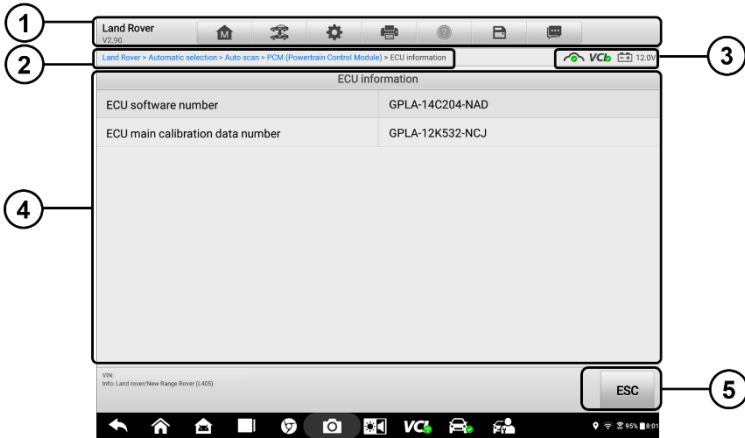

Figure 4-15 ECU Information Screen

1. Diagnostics Toolbar Buttons — see [Table 4-2 Diagnostics Toolbar Buttons](#) for detailed descriptions of the operations of each button.
2. Current Directory Path
3. Status Information Bar
4. Main Section — the left column displays the item names and the right column displays the specifications or descriptions.

5. Function Button — in this case, only an **ESC** button is available. Tap it to exit after viewing.

4.6 Trouble Codes

4.6.1 Read Codes

This function retrieves and displays DTCs from the vehicle's control system. The Read Codes screen varies for each vehicle being tested. For some vehicles, freeze frame data can also be retrieved for viewing.

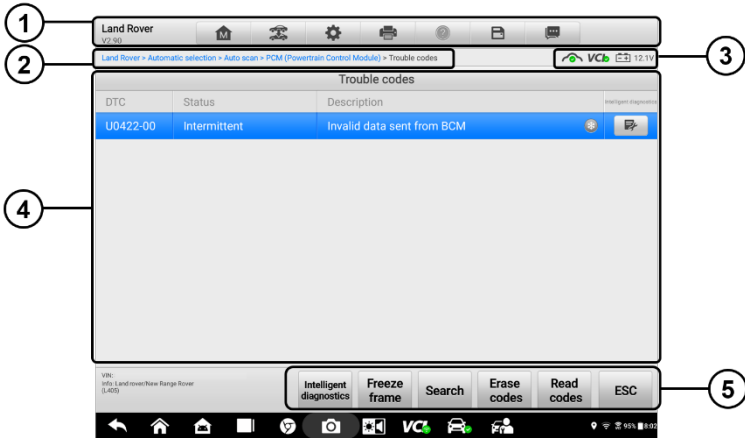

Figure 4-16 Read Codes Screen

1. Diagnostics Toolbar — see [Table 4-2 Diagnostics Toolbar Buttons](#) for details.
2. Current Directory Path
3. Status Information Bar
4. Main Section
 - Column 1 — displays the retrieved codes from the vehicle.
 - Column 2 — indicates the status of the retrieved codes.
 - Column 3 — displays detailed descriptions for the retrieved codes.
 - Column 4 — provides access to the Intelligent Diagnostics screen.
5. Function Buttons
 - **Intelligent Diagnostics** — enters the Intelligent Diagnostics screen to check related repair cases and help information.
 - **Freeze Frame** — a snowflake icon appears when freeze frame data is available for viewing. Tap to display data screen. The Freeze Frame interface is similar to

the Read Codes interface, thus shares similar operations.

- **Search** — searches the selected DTC for additional information on the Internet.
- **Erase Codes** — erases codes from the ECU. It is recommended that DTCs are read and needed repairs are performed before erasing codes.
- **Read Codes** — retrieves and displays the DTCs from the vehicle control system. The Read Codes screen varies for each vehicle being tested.
- **ESC** — returns to the previous screen or exits the function.

4.6.2 Erase Codes

After reading the retrieved codes from the vehicle and making repairs, you can erase the codes from the vehicle using this function. Before performing this function, make sure the vehicle's ignition key is in the ON (RUN) position with the engine off.

➤ To erase codes

1. Tap **Erase Codes** in the Function Buttons.
2. A warning message displays to inform you of data loss when this function is applied.
 - a) Tap **Yes** to continue. A confirmation screen displays when the operation is successfully done.
 - b) Tap **No** to exit.
3. Tap **ESC** on the confirmation screen to exit Erase Codes.
4. Perform the Read Codes function again to ensure the operation is successful.

4.7 Live Data

When this function is selected, the screen displays the data list for the selected module. The parameters appear in the order that they are transmitted by the ECU, so expect variation among vehicles.

Gesture scrolling allows you to quickly move through the data list. Drag your finger up or down on the screen to reposition the parameters being displayed if the data occupies more than one screen. The figure below displays a typical Live Data screen:

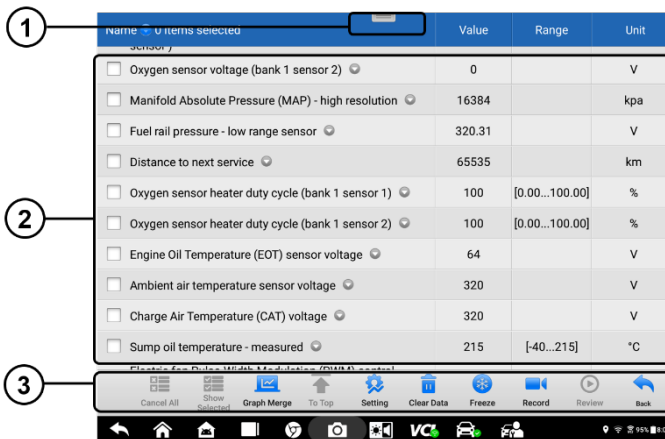

Figure 4-17 Live Data Screen

1. Diagnostics Toolbar Buttons — see [Table 4-2 Diagnostics Toolbar Buttons](#) for detailed descriptions of the operations for each button.
2. Main Section
 - Name Column — displays the parameters.
 - a) Check Box — tap the check box to the left of a parameter to select the item. Tap the check box again to deselect it.
 - b) Drop-down Button — tap the drop-down button to the right of a parameter to open a submenu and view data display-mode options.
 - Value Column — displays the values of the parameters.
 - Range Column — display the ranges of the parameters.
 - Units Column — displays the units for the parameters. Tap the **Settings** button in the top toolbar and select a required mode. See [Units](#) for details.

Display Mode

There are four display modes available for data viewing, allowing you to view various parameters in the mode best suited to represent the data.

Tap the drop-down menu to the right of a parameter to open a submenu. A total of 7 buttons will be displayed: The 4 buttons on the left represent different data display modes, plus an **Information** button (active when additional information is available), an **Unit Change** button (for switching the unit of displayed data), and a **Trigger** button (tap to open the "Trigger Settings" window).

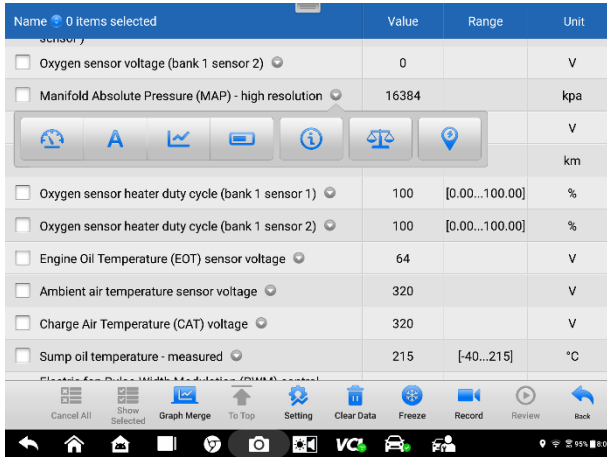

Figure 4-18 Display Mode Screen

Each parameter item displays the selected mode independently.

- ✦ **Analog Gauge Mode** — displays the parameters in gauge charts.
- ✦ **Text Mode** — the default mode that displays the parameters as a text list.

NOTE

Some status parameters, such as a switch reading like ON, OFF, ACTIVE, and ABORT, can only be displayed in Text Mode. Others, such as a sensor reading, can be displayed in both text and graph modes.

- ✦ **Waveform Mode** — displays the parameters in waveform graphs.

In this mode, five control buttons will appear to the right of the parameter, allowing you to manipulate the display status.

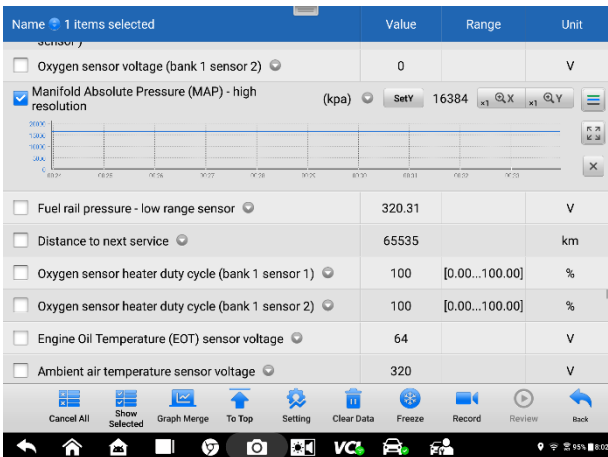

Figure 4-19 Waveform Graph Mode Screen

- Settings (SetY) — sets the minimum and maximum value of the Y-axis.
- Scale — changes the scale values.

There are two scale buttons displaying above the waveform graph to the right, which can be used to change the scale values of the X-axis and Y-axis of the graph. There are four scales available for the X-axis: x1, x2, x4 and x8, and three scales available for the Y-axis: x1, x2, and x4.

- Edit — tap to edit the waveform color and the line thickness.
- Zoom-in — tap once to display the selected data graph in full screen.
- Exit — tap to exit the waveform graph mode.

Full Screen Display — this option is only available in the waveform mode, and mostly used in Graph Merge status for data comparison. There are three control buttons available on the top-right side of the screen under this mode.

- Scale — tap to change the scale values below the waveform graph. There are four scales available for the X-axis: x1, x2, x4 and x8, and three scales available for the Y-axis: x1, x2, and x4.
- Edit — tap to open an edit window, in which you can set the waveform color and the line thickness displayed for the selected parameter.
- Zoom-out — tap to exit full screen display.
- Exit — tap to exit the waveform graph mode.

➤ **To edit the waveform color and line thickness in a data graph**

1. Select a parameter to be displayed in Waveform Graph mode.
2. Tap the **Edit** button, and an edit window displays.

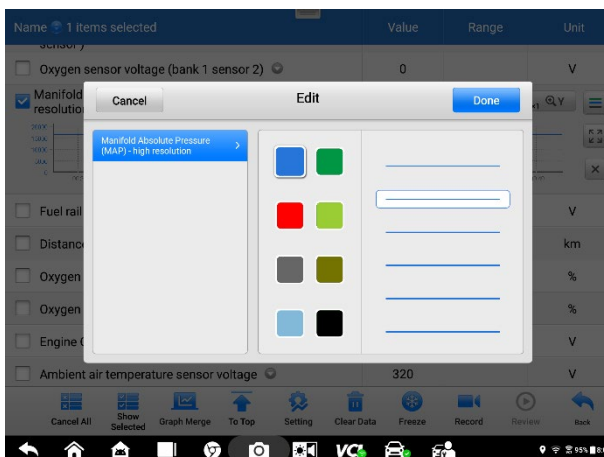

Figure 4-20 Waveform Edit Screen

3. The parameter is selected automatically in the left column.
4. Select a color from the middle column.
5. Select a line thickness from the right column.
6. Tap **Done** to save the settings and exit or tap **Cancel** to exit without saving.

NOTE

In the full screen display, edit the waveform color and line thickness by tapping the **Edit** button on the top-right side of the screen.

❖ **Digital Gauge Mode** — displays the parameters in the form of a digital gauge graph.

Trigger Settings

On the Trigger Settings screen, you can set a standard range by filling in minimum and maximum values. When exceeding these values, the trigger function will be executed and the device will automatically record and save the generated data. You can check the saved live data by tapping the **Review** button at the bottom of the screen.

Tap the drop-down button on the right side of a parameter to open a submenu. The **Trigger** button is the last one in the submenu. Tap to display the Trigger Settings dialog box.

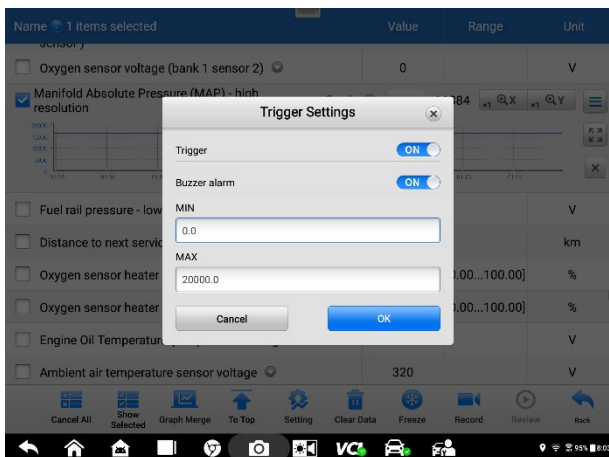

Figure 4-21 Trigger Settings Screen

Two buttons and two input boxes are available in the Trigger Settings dialog box.

- a) **Trigger On** — toggles the trigger on and off. The trigger is **ON** by default.
- b) **Buzzer Alarm** — switches the alarm on and off. The alarm function makes a beeping sound as an alert when the data reading reaches the preset minimum or maximum point. The buzzer alarm will only sound at the first trigger.
- c) **MIN** — displays a virtual keyboard to enter a lower threshold value.

d) **MAX** — displays a virtual keyboard to enter an upper threshold value.

➤ **To set a trigger**

1. Tap the drop-down button on the right side of a parameter to open a submenu.
2. Tap the **Trigger** button on the right side of the submenu to open the Trigger Settings window.
3. Tap the **MIN** input box and enter the minimum threshold value.
4. Tap the **MAX** input box and enter the maximum threshold value.
5. Tap **OK** to save the settings and return to the Live Data screen, or tap **Cancel** to exit without saving.

When the trigger is successfully set, a trigger mark displays in front of the parameter. The mark is gray when it is not triggered, and displays orange when triggered. Moreover, two horizontal lines display on each of the data graphs (when Waveform Graph Mode is applied) to indicate the alarm point. The limit lines are shown in different colors to differentiate them from the parameter waveforms.

3. Function Buttons

The operations of all available Function Buttons on the Live Data screen are described below:

- ✧ **Cancel All** — cancels all selected parameters. Up to 50 parameters can be selected at one time.
- ✧ **Show Selected/Show All** — switches between the two options; one displays the selected parameters, the other displays all available items.
- ✧ **Graph Merge** — merges selected data graphs (for Waveform Graph Mode only). This function is very useful when comparing different parameters.

➤ **To merge selected data graphs**

- 1) Select parameters to be merged.
- 2) Tap the **Graph Merge** button at the bottom of the Live Data screen.
 - a) This mode only supports parameters that can be represented digitally. If non-digital parameters are selected, a message will display advising the user that the selected parameters are not supported in this mode and to select 2 to 5 digital parameters. Tap the **Got It** button to return to the previous screen and select supported parameters.
 - b) If selected parameters are not supported in this mode, a message will display advising the user to only select the parameters that are supported. A message will also display if more than 5 parameters have been selected. Please select 2 to 5 of the supported parameters and tap the **OK** button to merge.

- 3) Tap **Cancel Merging** button at the bottom of the Live Data screen to cancel merge.
- ◇ **To Top** — moves a selected item to the top of the list.
 - ◇ **Setting** — sets the recording duration.
 - **To set live data record duration**
 1. Tap **Setting** button at the bottom of the Live Data screen.
 2. Tap the > button to the right of **Recording time after trigger** bar and select a time length.
 3. Tap **OK** to save the setting and return to the Live Data Setting screen or tap the **X** button at the upper-right corner to exit without saving.
 4. Tap **Done** at the upper-right corner of the Live Data Setting screen to confirm and save the setting and return to the Live Data screen or tap **Cancel** to exit without saving.
 - ◇ **Clear Data** — clears all cached live data.
 - ◇ **Freeze** — displays the retrieved data in freeze mode.
 - Previous Frame — moves to the previous frame of frozen data.
 - Next Frame — moves to the next frame of frozen data.
 - Play/Pause — plays/pauses the frozen data.
 - Resume — exits the freeze data mode and returns to normal data display.
 - ◇ **Record** — starts recording the live data of the selected items. Tap the **Record** button at the bottom of the Live Data screen. A message will display prompting user to select parameters to record. Tap the **Got It** button to confirm. Scroll down and select data to record. Tap the **Record** button to start recording. Tap the **Resume** button to stop recording. The recorded live data can be viewed in the **Review** section at the bottom of the Live Data screen. The recorded data can also be reviewed in the Data Manager application.
 - Resume — stops data recording and returns to normal data display.
 - Flag — displays when the Record function is applied. Tap this button to set flags to note points of interest when recording data. Notes can be added during playback in Review or Data Manager. Select the preset flag to open a popup window and display a virtual keyboard to input notes.
 - ◇ **Review** — reviews the recorded data. Tap **Review** to display a recording list and select one item to review.

NOTE

Only the data recorded during the current operation can be reviewed on the Live Data screen. All the historical recorded data can be reviewed in "Review Data" in the Data Manager application.

- Previous Frame — switches to the previous frame of recorded data.
- Next Frame — switches to the next frame of recorded data.
- Play/Pause — plays/pauses the recorded data.
- Show Selected — displays the selected parameters.
- Graph Merge — merges selected data graphs.
- Back — exits the review, and returns to the Live Data screen.

❖ **Back** — returns to the previous screen or exits the function.

4.8 Active Test

The Active Test function is used to access vehicle-specific subsystem and component tests. Available tests vary by vehicle.

During an active test, the tablet sends commands to the ECU to activate the actuators. This test determines the integrity of the system or part by reading ECU data, or by monitoring the operation of the actuators. Such tests may include switching a solenoid, relay or switch, between two operating states.

Selecting Active Test displays a menu of test options. Available tests vary by vehicle. Select a test from menu options. Follow the instructions displayed on the screen to complete the test. Procedures and instructions vary by vehicle.

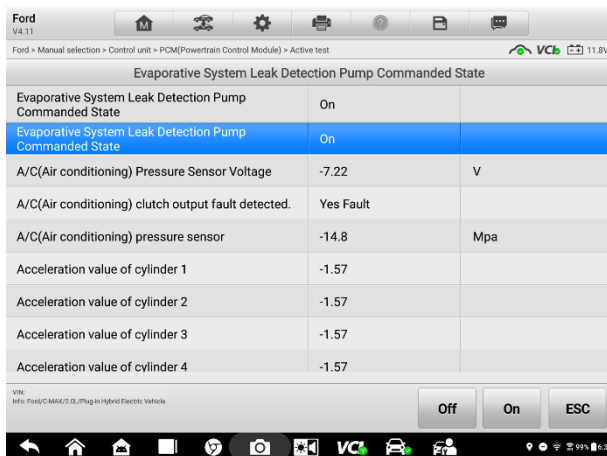

The screenshot shows the 'Active Test' interface for a Ford vehicle. The title bar indicates 'Ford V4.11' and the breadcrumb path is 'Ford > Manual selection > Control Unit > PCM(Powertrain Control Module) > Active test'. The current test is 'Evaporative System Leak Detection Pump Commanded State'. The table below displays various vehicle parameters and their current values.

Evaporative System Leak Detection Pump Commanded State		
Evaporative System Leak Detection Pump Commanded State	On	
Evaporative System Leak Detection Pump Commanded State	On	
A/C(Air conditioning) Pressure Sensor Voltage	-7.22	V
A/C(Air conditioning) clutch output fault detected.	Yes Fault	
A/C(Air conditioning) pressure sensor	-14.8	Mpa
Acceleration value of cylinder 1	-1.57	
Acceleration value of cylinder 2	-1.57	
Acceleration value of cylinder 3	-1.57	
Acceleration value of cylinder 4	-1.57	

At the bottom of the screen, there are three buttons: 'Off', 'On', and 'ESC'. The status bar at the very bottom shows 'VIN: Ford/C-MAX/2.0_iPlug-In Hybrid Electric Vehicle' and various system icons.

Figure 4-22 Active Test Screen

The Function Buttons in the lower-right corner of the Active Test screen manipulate the test signals. The operational instructions are displayed in the main section of the test screen. Follow the on-screen instructions and make appropriate selections to complete the tests.

Tap the **ESC** function button to exit the test when finished.

4.9 Special Functions

These functions perform various component adaptations, including the recalibration or configuration of certain components after repairs or replacements have been completed.

Select a function to display detailed information and the execution screen. Special functions vary by vehicle. Follow the on-screen instructions and make appropriate selections to complete the function.

4.10 Programming and Coding

Since the introduction of OBDII and leading up to modern hybrids and EVs, hardware and software technologies in cars have been advancing at an exponential rate. Updating software may be the only way to fix the following issues:

- Drivability
- Fuel Efficiency
- Power Loss
- Fault Codes
- Durability of Mechanical Parts

The Programming and Coding function is used to re-flash the vehicle control modules, which allows you to update the computer software of the vehicle to the latest version, as well as to reprogram adaptive data of certain components after making repairs or replacements.

NOTE

The programming function applies only when the vehicle is connected with a VCI, which serves as a PassThru interface to establish communication with and transfer data to the vehicle's ECU.

Available programming or coding operations vary by test vehicle. Only available operations display in the tablet menu.

There are two general types of programming operations:

- A. Coding — also known as *Teach-in Program* or *Component Adaptation*, is used to reprogram adaptive data for vehicle control modules after repairs or replacements of vehicle parts.
- B. Reprogramming — downloads the latest software from the online server database

through Internet access (this procedure is done automatically when the tablet is connected to the Internet, so there is no need to check for software updates), and reprograms the newest version into the vehicle's ECU.

 **NOTE**

Ensure that the tablet is connected to a stable Internet access before applying the ECU programming function, so that the tablet is able to obtain access to the vehicle manufacturer's server for update service.

Selecting the Programming or Coding function opens a menu of operation options that varies by vehicle make and model. Selecting a menu option either displays a programming interface or opens another menu of additional choices. Follow all screen instructions while performing the programming or coding operations. How and what information is presented on the screen vary by the type of operation being performed.

4.10.1 Coding

The main section of the Coding screen displays a list of vehicle components and the coding information that mainly consists of two parts:

1. All available systems for coding are displayed on the left side, and the coding data or value on the right side.
2. The bottom of the main section displays the Function Buttons that enable you to manipulate the operation.

Check the vehicle condition and the coding information carefully. Use the Function Button to edit codes for the corresponding components. Tap **Send** when you finish editing all items. When the operation is completed, an execution status message such as Completed, Finished or Successful, may display.

Tap the **ESC** button to exit the function.

4.10.2 Reprogramming

Before reprogramming begins

- It is mandatory that the tablet is connected to a stable Wi-Fi network.
- Tablet must be connected to VCI by USB.
- Tablet battery must be fully charged during module programming. Connect tablet to a charger if needed.
- Attach battery maintainer to vehicle battery to ensure a steady voltage is maintained throughout programming. Voltage requirements differ by vehicle manufacturer. Consult vehicle manufacturer recommendations prior to programming a module.
- Do not quit the application during a module programming as the process may fail and

may also result in permanent damage to the module.

Typical reprogramming operations require you to input and validate VIN number first. Tap the input box and enter the correct number. The programming interface then displays.

The main section of the reprogramming interface offers information of the hardware, the current software version and the newest software versions to be programmed into the control units. A series of on-screen operational instructions will display to guide you through the programming procedure.

Carefully read the on-screen information and follow the instruction to execute the programming procedure.

4.10.3 Re-flash Errors

! IMPORTANT

When reprogramming onboard, always make sure the vehicle battery is fully charged and in good working condition. During reprogramming, the operation may fail if voltage falls below the proper operation voltage. Sometimes a failed operation can be recovered, but the failed reprogramming can also ruin the control module. We recommend connecting an external battery maintainer to the vehicle to ensure a steady voltage is maintained throughout programming. The required voltage differs by vehicle manufacturer. Consult vehicle manufacturer for correct voltage to be maintained.

Occasionally a flash update procedure may not complete properly. Common causes of flash errors include: poor cable connections among the tablet, VCI, and vehicle, the vehicle ignition being switched off before the flash procedure is complete, or low vehicle battery voltage.

If the process quits, recheck all the cable connections to assure good communications and initialize the flash procedure. The programming procedure will automatically repeat if the previous operation does not succeed.

4.11 Generic OBDII Operations

The OBDII/EOBD vehicle diagnosis option offers a quick way to check for DTCs, isolate the cause of an illuminated Malfunction Indicator Lamp (MIL), check monitor status prior to emissions certification testing, verify repairs, and perform other emissions-related services. The OBDII direct access option is also used for testing OBDII/EOBD-compliant vehicles that are not included in the Diagnostics database. Diagnostics toolbar buttons at the top of the screen are available for specific vehicle diagnostics. See [Table 4-2 Diagnostics Toolbar Buttons](#) for details.

4.11.1 General Procedure

➤ To access the OBDII/EOBD diagnostics functions

1. Tap the **Diagnostics** application button in the MaxiSys Job Menu. The Vehicle Menu displays.
2. Tap the **EOBD** button. There are two options to establish communication with the vehicle.
 - Auto Scan — select it to establish communication using each protocol in order to determine which one the vehicle is using.
 - Protocol — select it to open a submenu of various protocols. A communication protocol is a standardized way of data communication between an ECU and a diagnostic tool. Global OBD may use several different communication protocols.
3. Select a specific protocol if the **Protocol** option is selected. Wait for the OBDII Diagnostic Menu to appear.

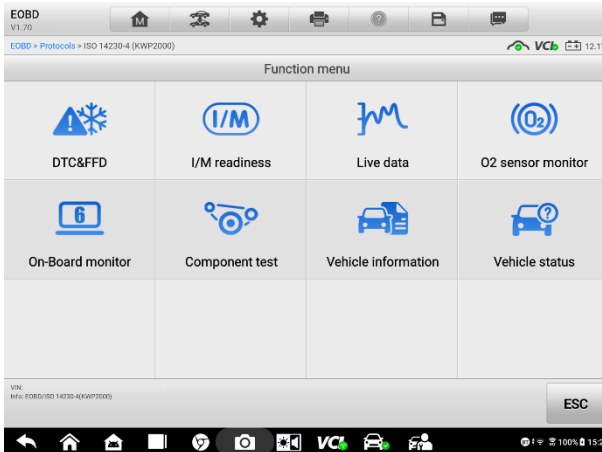

Figure 4-23 Sample OBDII Diagnostic Menu

4. Select a function to continue.
 - DTC & FFD
 - I/M Readiness
 - Live Data
 - O2 Sensor Monitor
 - On-Board Monitor
 - Component Test
 - Vehicle Information

- Vehicle Status

NOTE

Supported functions may vary by vehicle.

4.11.2 Function Descriptions

This section describes the various functions of each diagnostic option:

DTC & FFD

When this function is selected, the screen displays a list of Current Codes and Pending Codes. When the Freeze Frame data of certain DTCs are available for viewing, a snowflake icon will display on the right side of the DTC item. The Erase Codes function can be applied by tapping the Function Button at the bottom of the screen.

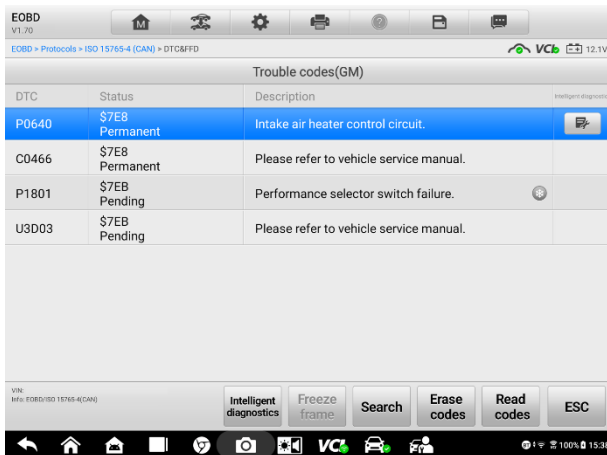

Figure 4-24 Sample DTC & FFD Screen

- **Current Codes**

Current codes are emission-related DTCs from the ECU of the vehicle. OBDII/EOBD Codes have a priority according to their emissions severity, with higher-priority codes overwriting lower-priority ones. The priority of the code determines the illumination of the Malfunction Indicator Lamp (MIL) and the erasing-code procedure. Manufacturers rank codes differently, so DTCs may vary by vehicle.

- **Pending Codes**

These are codes whose storing conditions have been met during the last drive cycle, but need to be met on two or more consecutive drive cycles before the DTC stored. The purpose of displaying pending codes is to assist the service technician after a vehicle repair when diagnostic information is cleared, by reporting test results after a single driving cycle.

- a) If a test fails during the driving cycle, the DTC associated is reported. If the pending fault does not occur again within 40 to 80 warm-up cycles, the fault is automatically cleared from memory.
- b) Test results reported do not necessarily indicate a faulty component or system. If test results indicate another failure after additional driving, a DTC is stored to indicate a faulty component or system.

- **Freeze Frame**

In most cases, the stored frame is the last-DTC reported. Certain DTCs, those that have a greater impact on vehicle emissions, have a higher priority. In these cases, DTC of the highest priority is the one for which the freeze frame records are retained. Freeze frame data includes a “snapshot” of critical parameter values at the time the DTC is stored.

- **Erase Codes**

This option is used to clear all emission-related diagnostic data including DTCs, freeze frame data, and specific manufacturer-enhanced data from the vehicle ECU. This option resets the I/M Readiness Monitor Status for all vehicle monitors to Not Ready or Not Complete status.

A confirmation screen displays when the clear codes option is selected to prevent accidental loss of data. Select **Yes** on the confirmation screen to continue, or **No** to exit.

I/M Readiness

This function is used to check the readiness of the monitoring system. It is an excellent function to use prior to having a vehicle inspected for state emissions compliance. Selecting I/M Readiness opens a submenu with two choices:

- Since DTCs Cleared — displays the status of monitors since the last time the DTCs are erased.
- This Driving Cycle — displays the status of monitors since the beginning of the current drive cycle.

Live Data

This function enables the display of real-time PID data from the ECU. Displayed data includes analog and digital input and output, and system status information broadcast in the vehicle data stream.

Live data can be displayed in various modes. See [Live Data](#) for detailed information.

O2 Sensor Monitor

This function allows retrieval and review of recent O2 sensor monitor test results stored on the vehicle on-board computer.

The O2 Sensor Monitor test function is not supported by vehicles that communicate using a controller area network (CAN). For O2 Sensor Monitor test results of CAN-equipped vehicles, refer to [On-Board Monitor](#).

On-Board Monitor

This function allows you to view the results of On-Board Monitor tests. The tests are useful after the service when a vehicle control module memory is already erased.

Component Test

This function enables dual-directional control of the ECU so that the diagnostic tool can transmit control commands to operate the vehicle systems. This function is useful in determining how well the ECU responds to a command.

Vehicle Information

This function enables the display of the vehicle identification number (VIN), calibration identification number, calibration verification number (CVN), and other information of the test vehicle.

Vehicle Status

This function checks the current condition of the vehicle, such as the communication protocols of OBDII modules, number of fault codes, and status of the Malfunction Indicator Light (MIL).

4.12 Diagnostic Report

4.12.1 Pre-Scan and Post-Scan

- Auto Scan the Vehicle — the Auto VID function can automatically identify the vehicle and its equipped systems. All available modules in all systems will be scanned automatically. Then the DTCs and code details will be listed.
- Print Pre-scan Report — vehicle images can be taken by the tablet and attached to a scan report. The report can be generated and submitted. The report can be customized with shop and vehicle information.
- Repair Vehicle — creates efficient repair plan from the start.
- Auto Scan Repaired Vehicle — ensures no new faults were created during repair and no DTCs are present at completion.
- Print Post-scan Report — proves all DTCs on Pre-scan report are fixed.

4.12.2 Diagnostics Report Saving, Viewing, and Sharing

Diagnostics reports can be reviewed, saved, and shared with others in many ways.

Diagnostics Report Saving

a) Via the **History** function:

- Tap **Diagnostics** on the MaxiSys Job Menu and tap **History** in the Top Toolbar.

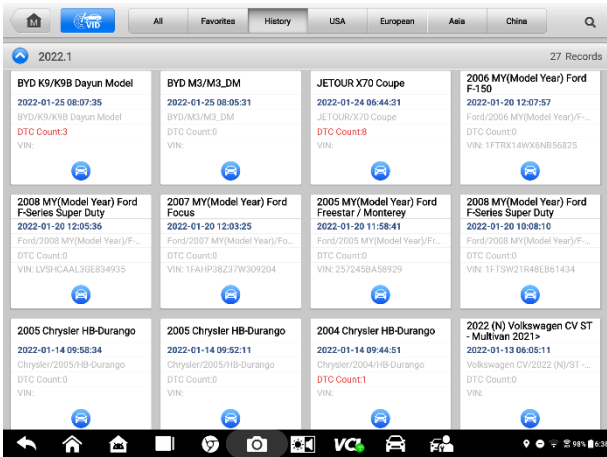

Figure 4-25 History Screen

- Select a history record, and tap the **...** button in the upper-right corner to view the PDF document, print, email or delete the historical test.

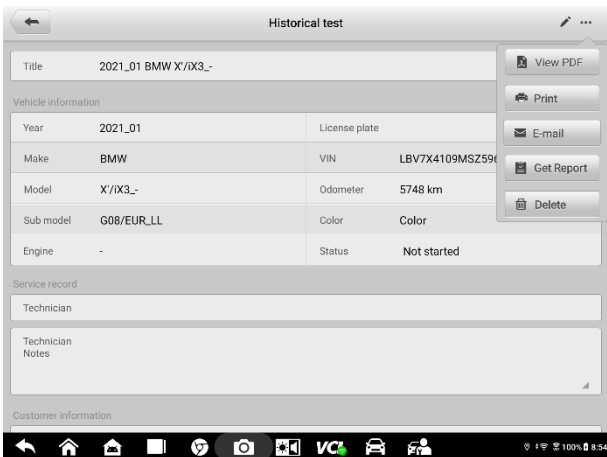

Figure 4-26 Historical Test Screen

- Tap **View PDF** to view the report directly. Or tap **Get Report**, enter the license plate and current mileage, and tap **Save > View Report** to save and view the report.
- b) Via the **Auto Scan** function:
- Enter the Auto Scan page and tap **Fault Scan** in the Function Button Bar at the bottom of the screen.

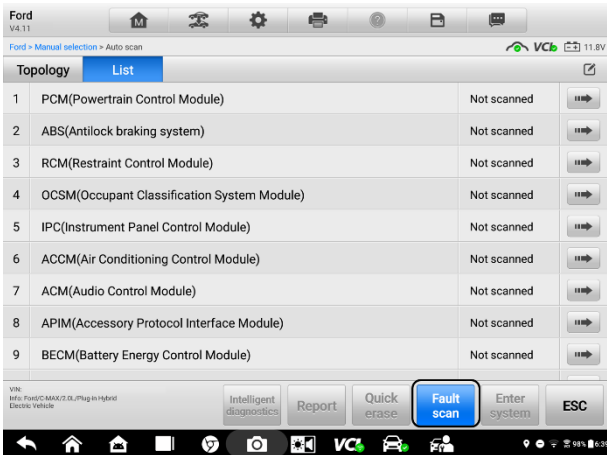

Figure 4-27 Auto Scan Screen 1

- When the system scan is completed, tap **Report** in the Function Button Bar at the bottom of the screen.

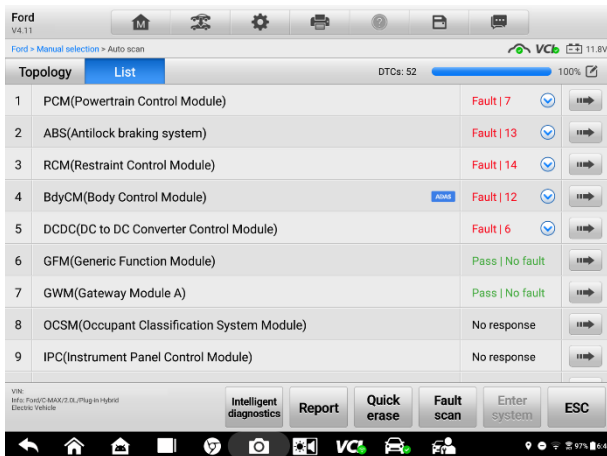





Figure 4-28 Auto Scan Screen 2

- Tap the  button in the Diagnostics Toolbar and select **Save All Data**. Enter the license number and tap **Save**. Tap the  button on the upper-right of the screen to view the report.
- Tap the  button in the Diagnostics Toolbar and select **Save Report**. Enter the license plate and current mileage. Tap **Save > View Report** and then select a saved report to view.

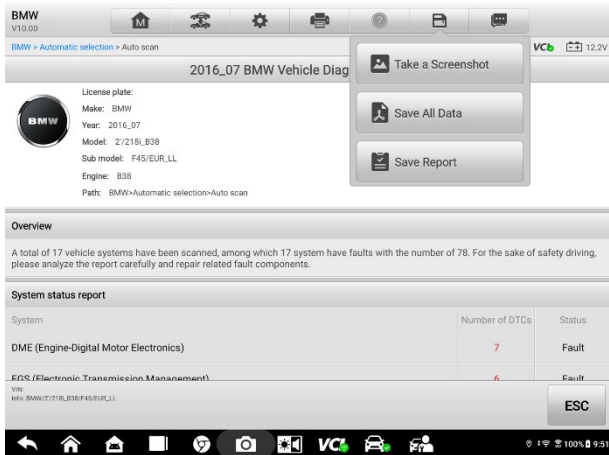

Figure 4-29 Auto Scan Screen 3

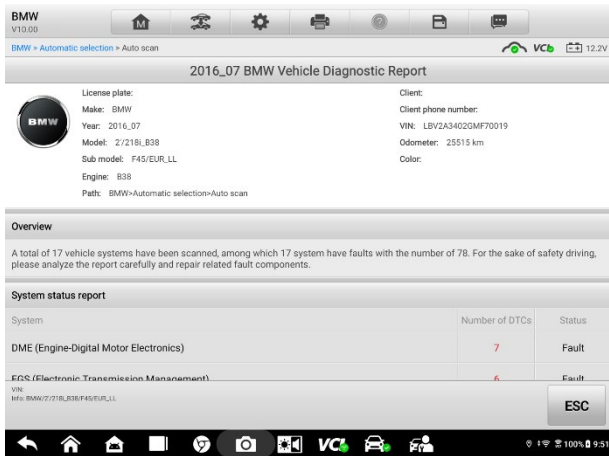



Figure 4-30 PDF Document Screen

c) Via the functions on the Navigation Bar

- The diagnostic report can also be viewed from such diagnostics function screens including Auto Scan, Trouble Codes, Live Data, and Active Test. Tap the  button in the Diagnostics Toolbar, and select **Save All Data** to save and view the PDF document.

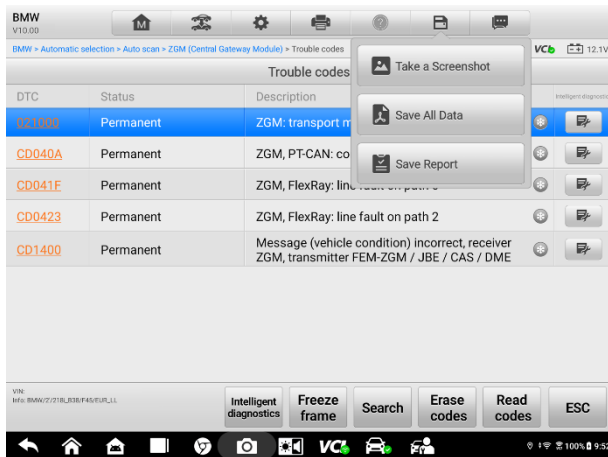

Figure 4-31 Read Codes Screen

Diagnostics Report Viewing

All the saved reports can be viewed in the Data Manger application.

- ✦ Tap **Data Manager > Vehicle History**. Select a specific vehicle history record and then tap **View PDF** in the upper-right corner to view the report.
- ✦ Once you save the reports by tapping the **Save All Data** button, tap **Data Manager > PDF** to view these local reports.
- ✦ Once you save the reports by tapping the **Get Report or Save Report** button, tap **Data Manager > Report** to view these reports saved to the Autel cloud platform.

Diagnostics Report Cloud Sharing

- Tap **Data Manager > Report** to enter the Report List screen.

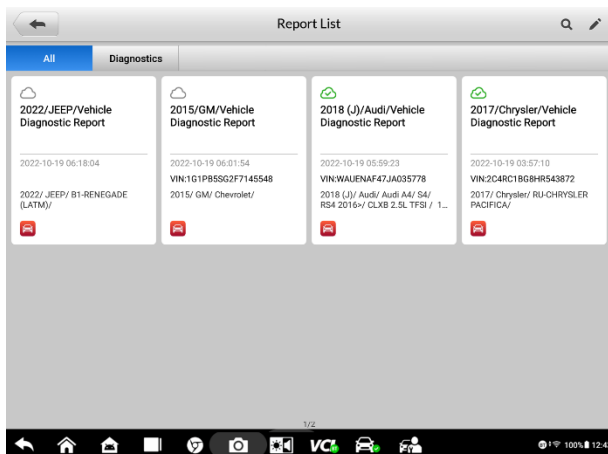





Figure 4-32 Report List Screen 1

NOTE

Note that if the report displays  , it means the report has been uploaded to the cloud successfully, and you can share the report with others; if the report displays  , it means the report has failed to upload to the cloud, but will try to automatically upload to the cloud when entering the Report again.

- Tap on a report displaying  , then select **Report Cloud Sharing**.

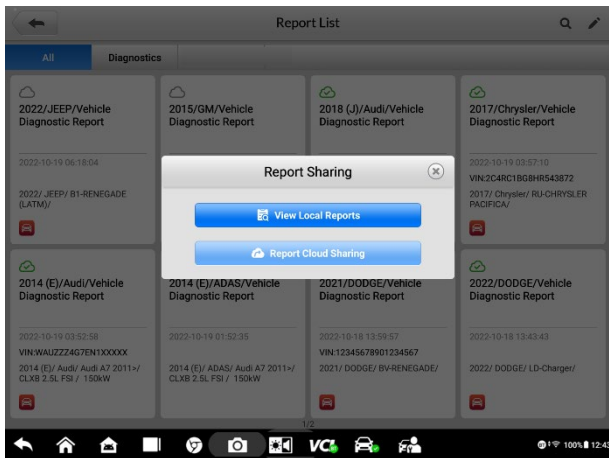

Figure 4-33 Report List Screen 2

- There are three ways to share reports in the cloud: scan the QR code, send by email, and send by SMS (via phone number).

4.13 Exit Diagnostics

The Diagnostics application operates while communication with the vehicle is still active. It is important to properly exit from the diagnostics operation interface to stop all communications with the vehicle before closing the Diagnostics application.

NOTE

Damage to the vehicle Electronic Control Module (ECM) may occur if the communication is disrupted. Ensure all forms of communication links such as data cable, USB cable, and wireless or wired network, are properly connected throughout the test. Exit all interfaces before disconnecting the test cable and power supply.

➤ To exit the Diagnostics

1. On an active diagnostic screen, tap the **Back** or **ESC** button to exit an diagnostic session. Or
2. Tap the **Vehicle Swap** button in the diagnostics toolbar to return to the Vehicle Menu screen. On the Vehicle Menu screen, tap the **Home** button in the top toolbar, or tap the **Back** button in the navigation bar at the bottom of the screen.

Or

3. Tap the **Home** button in the diagnostics toolbar to exit the application directly and return to the MaxiSys Job Menu.

Now, the Diagnostics application is no longer communicating with the vehicle and it is safe to open other MaxiSys applications, or exit the MaxiSys diagnostics system and return to the Android System's Home screen.

5. Intelligent Diagnostics

Intelligent Diagnostics is a specific fault code analysis function, with which you can access the most comprehensive and the latest code-specific data, DTC analysis, repair assist, repair tips, and relevant repair cases. It has been drawn from shop repair orders and records and with input from experienced industry professionals.

Intelligent Diagnostics adopts the scientific data cloud computing technology to match the specific fault code with the exact vehicle model. And the data has been thoroughly verified by automotive maintenance professionals.

The following are main parts of the code data contained in Intelligent Diagnostics:

1. Vehicle System and Detected DTC(s)
2. Technical Service Bulletin (OEM Information)
3. DTC Analysis
4. Repair Assist
5. Repair Tips
6. Component Measurement
7. Relevant Cases

NOTE

Before performing the Intelligent Diagnostics function, please ensure the network is connected successfully.

5.1 Accessing Intelligent Diagnostics Function



5.1.1 Auto Scan

Before starting Intelligent Diagnostics, please ensure that vehicle communication has been established. Connect the MaxiSys MS909 tablet to the test vehicle through the VCI. For detailed directions to establish vehicle communication with the MaxiSys tablet, see [Establish Vehicle Communication](#).

Once communication has been established, enter the **Diagnostics** application and select a vehicle model. After a vehicle model is selected, tap **Auto Scan** from the Main Menu. The Main Section of Auto Scan screen displays a list for most vehicles. A Topology is also displayed for main makes. For detailed instructions on using the Auto scan function, see [Auto Scan](#).

5.1.2 Access the Intelligent Diagnostics Screen

After scanning system faults, there are four methods to access the Intelligent Diagnostics screen:

- Access via the **Intelligent Diagnostics** button to view code-related information of all DTCs for the whole vehicle
- Access via the Intelligent Diagnostics icon  to view code-related information of a specific DTC
- Access via the **Enter System** button to view code-related information of a specific DTC
- Access via the Enter System icon  to view code-related information of a specific DTC

Access via Intelligent Diagnostics Button

After all the faults of the vehicle systems are scanned, if the Intelligent Diagnostics function is available for this vehicle, the **Intelligent Diagnostics** button will be active. Tap the **Intelligent Diagnostics** button on the lower corner of the List screen or the Topology screen to directly enter the Intelligent Diagnostics screen.

- On the **List** screen

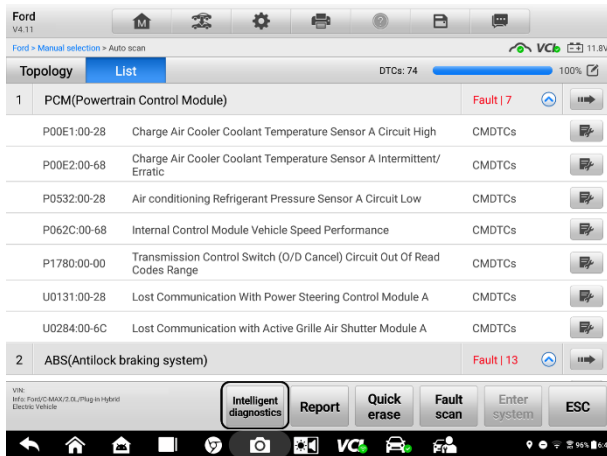



Figure 5-1 Intelligent Diagnostics Button (List Screen)

- On the **Topology** screen



Figure 5-2 Intelligent Diagnostics Button (Topology Screen)

Access via Intelligent Diagnostics Icon

You can also use the Intelligent Diagnostics icon  on the List screen or the Topology screen to get detailed fault repair instructions of a specific DTC.

- On the **List** screen, the details of the detected fault(s), including the fault code, fault description, and status, will be displayed right under the system name or module. If the Intelligent Diagnostics function is available for this DTC, the Intelligent Diagnostics icon will display on the right of the screen.

Tap the Intelligent Diagnostics icon  to enter the Intelligent Diagnostics screen.

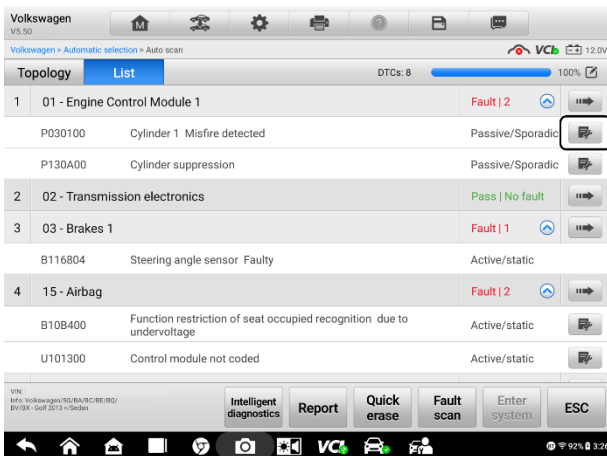



Figure 5-3 Intelligent Diagnostics Icon (List Screen)

- On the **Topology** screen, once the system scan is complete, tap a system icon (displays in orange if faults are detected) to display complete system name with the Intelligent Diagnostics icon shown below. Tap the Intelligent Diagnostics icon 

to enter the Intelligent Diagnostics screen. The Intelligent Diagnostics icon appears only when the system supports the intelligent diagnostics function.



Figure 5-4 Intelligent Diagnostics Icon (Topology Screen)

Access via Enter System Button

- On the **List** Screen

1. Select a system. Tap the **Enter System** button at the bottom of the screen.

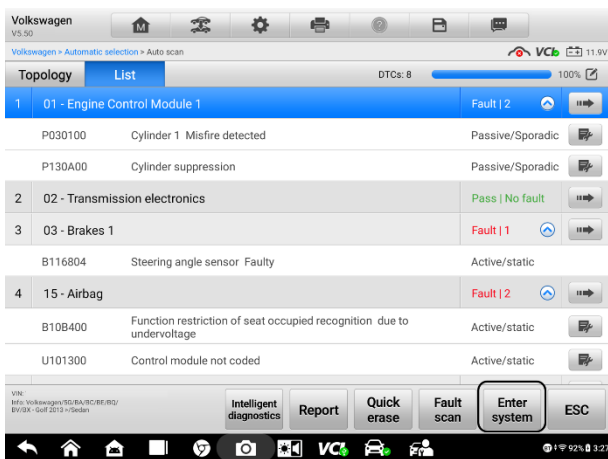

Figure 5-5 Enter System Button (List Screen)

2. Select **Trouble Codes** from the Function Menu screen and the trouble codes screen will display.

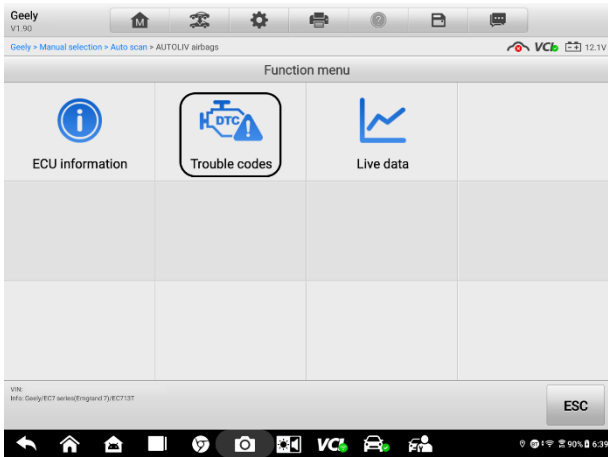



Figure 5-6 Function Menu Screen

3. Tap the Intelligent Diagnostics icon  to the right of the DTC description. Or select a specific DTC from the DTC list, and then tap the **Intelligent Diagnostics** button at the bottom of the screen.

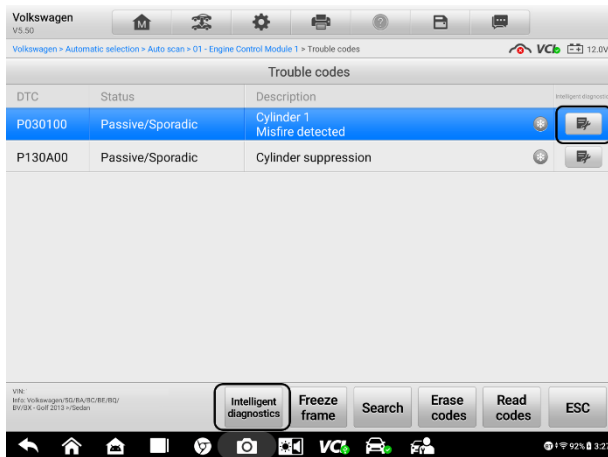

Figure 5-7 Trouble Codes Screen

- On the **Topology** Screen
1. Tap a system icon. Tap the **Enter System** button at the bottom of the screen.



Figure 5-8 Enter System Button (Topology Screen)

- After tapping the **Enter System** button on the Topology screen, the rest of the steps are the same in the List screen.

Access via Enter System Icon

When entering a specific system by tapping the Enter System icon , you can also access the Intelligent Diagnostic screen if the Intelligent Diagnostics function is available for this vehicle.

- On the **List** Screen

Tap the Enter System icon  to enter a system, then follow the instructions in the [Access via Enter System Button](#) section to continue.

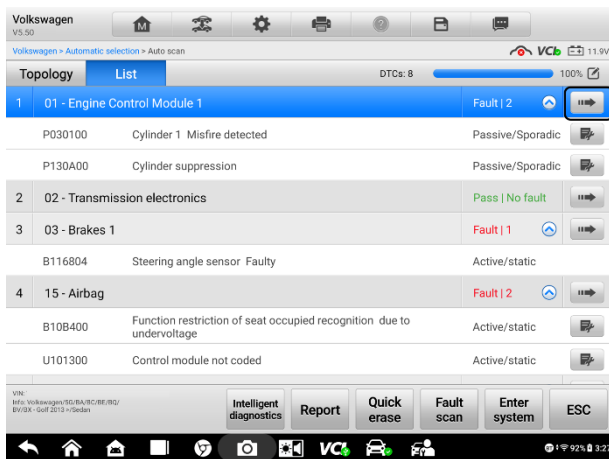



Figure 5-9 Enter System Icon (List Screen)

- On the **Topology** Screen

Tap a system name, the Intelligent Diagnostics icon and Enter System icon will appear. Tap the Enter System icon  to enter a system, then follow the instructions in the [Access via Enter System Button](#) section to continue.

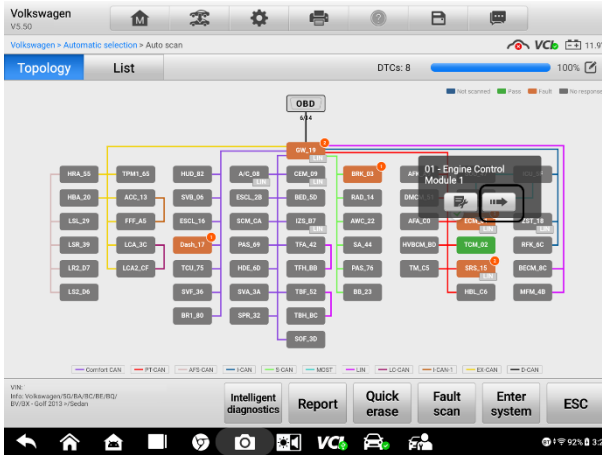

Figure 5-10 Enter System Icon (Topology Screen)

5.2 Intelligent Diagnostics Operation

Intelligent Diagnostics is an important and powerful function of MaxiSys MS909. It provides substantial information for intelligent diagnosis of the faults detected, offering Technical Service Bulletin, DTC Analysis, Repair Assist, Repair Tips, and Component Measurement to help you repair detected faults. It also provides relevant repair case information for viewing.

The **Intelligent Diagnostics** function consists of the following sections:

1. **Vehicle System and Detected DTC(s)** — displays the name of the vehicle system(s) and the detected DTC(s).
2. **Technical Service Bulletin** — contains DTC-related recalls, TSB, and OEM campaigns.
3. **DTC Analysis** — provides repair assistance information related to the fault code.
4. **Repair Assist** — intelligently prioritizes DTCs and leads the user to the proper repair.
5. **Repair Tips** — details the steps for determining and clearing faults.
6. **Component Measurement** — provides detailed information and guides on using an oscilloscope to test components for faults.
7. **Relevant Cases** — offers relevant fault-clearing repair cases for reference.

5.2.1 Vehicle System and Detected DTC(s)

This section displays the scanned vehicle systems that contain faults. Tap the drop-down menu to view comprehensive information of All Systems or switch to different fault codes for details.

Tap the arrow button on the right to display a drop-down list of all systems along with specific DTCs. Use your finger to touch and slide upward or downward on the screen to review all codes in the list. Select All Systems or select a DTC to view the corresponding Intelligent Diagnostics information.

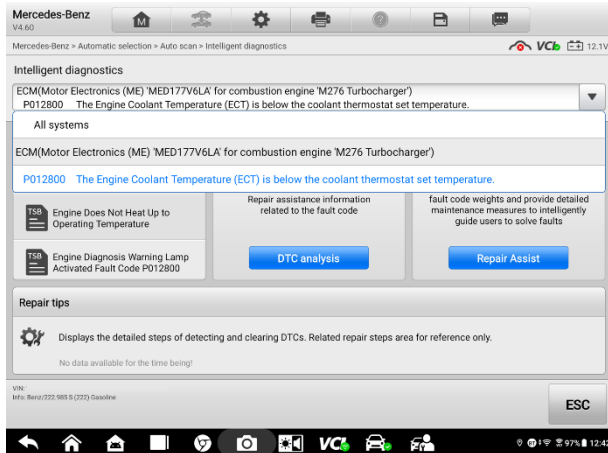

Figure 5-11 Vehicle System and Detected DTC(s) Screen

5.2.2 Technical Service Bulletin (OEM Information)

The Technical Service Bulletin (TSB) function matches the selected fault code with relevant vehicle manufacturer TSBs. All TSBs that relate to the selected DTC are listed in the TSB display window. Select a TSB to open the page and view details.

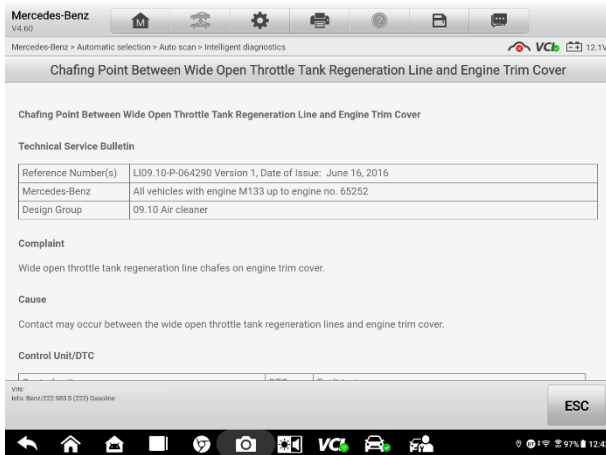

Figure 5-12 TSB in Details

5.2.3 DTC Analysis

On the **Intelligent Diagnostic** screen, the DTC Analysis contains repair assistance and information related to the fault codes, including the DTC description, fault description, condition, fault influence, possible cause, and possible solution. The repair assistance information vary by vehicle.

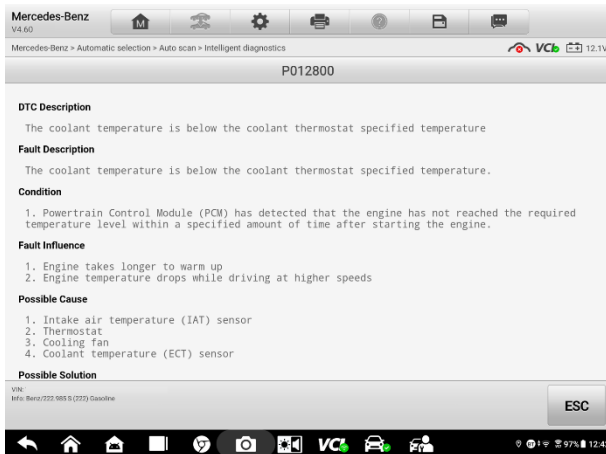

Figure 5-13 DTC Analysis Screen

5.2.4 Repair Assist

The Repair Assist displays a list of items and their descriptions, completion status, and priorities. The higher the priority number is (1 is the highest), the earlier the related items will be tested.

➤ **To perform Repair Assist**

1. Tap the **Repair Assist** button on the Intelligent Diagnostics screen.

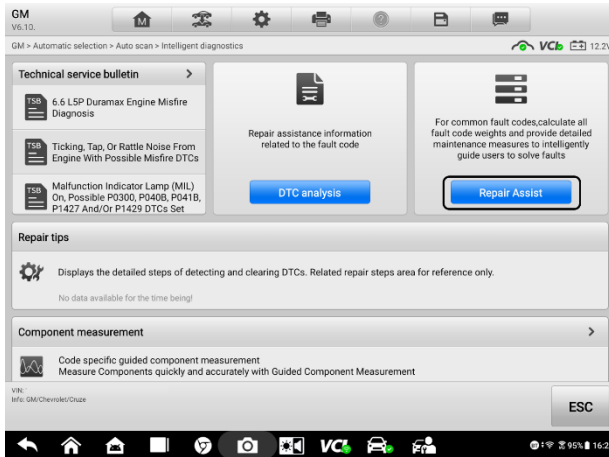



Figure 5-14 Repair Assist Screen 1

2. Tap the **Run** button from the Function Buttons section or tap the  icon on the right of the selected item to perform Repair Assist function.

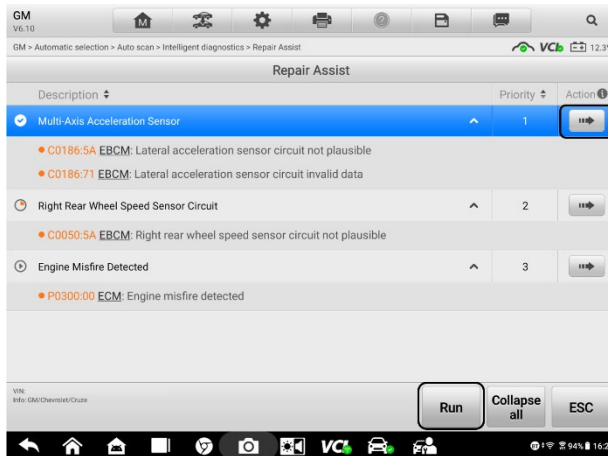

Figure 5-15 Repair Assist Screen 2

3. Select a brand and tap the **Continue** button to go to the next step. Please note that when there is more than one DTC in Select Branch, the one that has been selected is highlighted in blue.

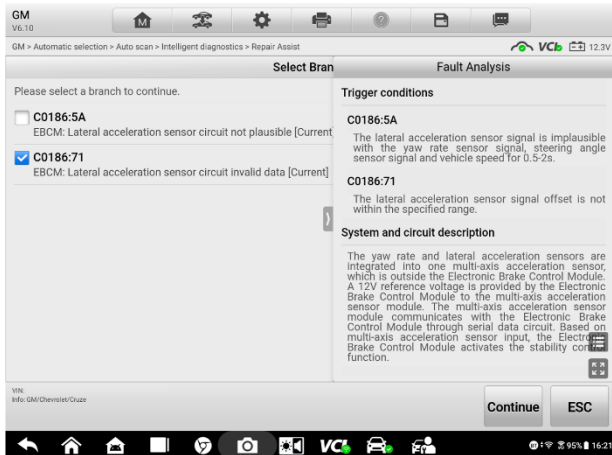



Figure 5-16 Repair Assist Screen 3

NOTE

In some cases, you need to tap this icon  to fold the right column so that the whole interface of Select Branch can be shown.

4. In the repair process, it may integrate one or more diagnostic functions such as Read Codes, Erase Codes, Live Data, Freeze Frame, and Active Test as needed.

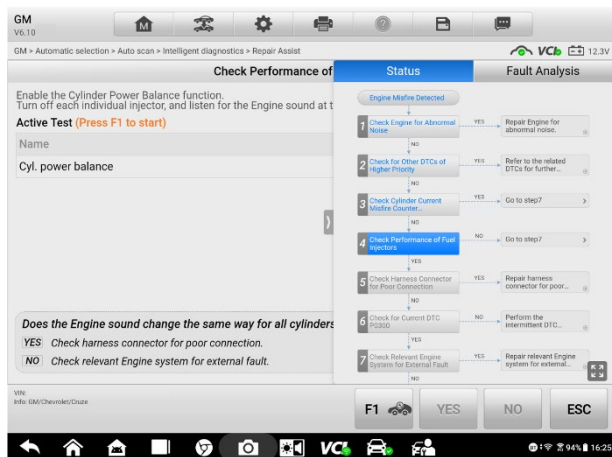





Figure 5-17 Repair Assist Screen 4

5. In some cases, it is necessary to check the circuits. Tap the **Link icon**  to open the Wiring Diagram screen and select the Wiring tab.

Tap the  button in the upper-right corner, and you will be able to locate the components, connector, wiring, and ground electrodes by tapping the names in the list when necessary. Tap the  button to display in full screen and tap  to return to the previous screen.

to exit the full-screen display mode.

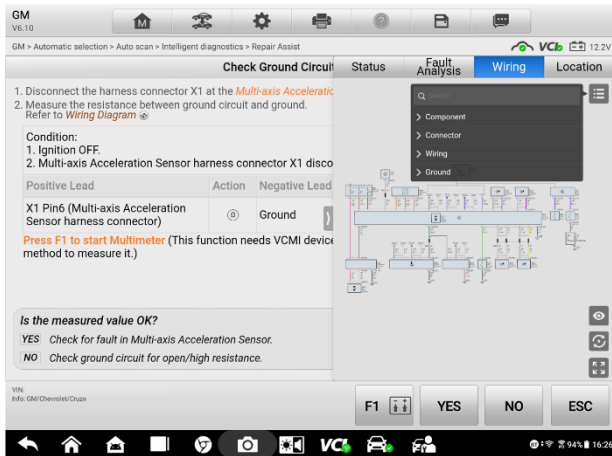



Figure 5-18 Repair Assist Screen 5

6. For some vehicles, the component location can be displayed on the screen. Tap the **Link icon**  to open the Wiring Diagram screen and select the Location tab.

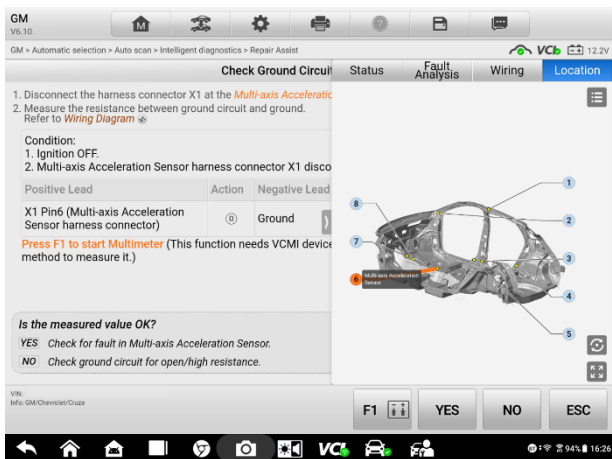



Figure 5-19 Repair Assist Screen 6

7. If you want to view details of the connector, tap the **Link icon**  and select the Connector tab. Measure the resistance/voltage/current between the two pins according to the prompts in the multimeter to see if the measured value is OK or not.

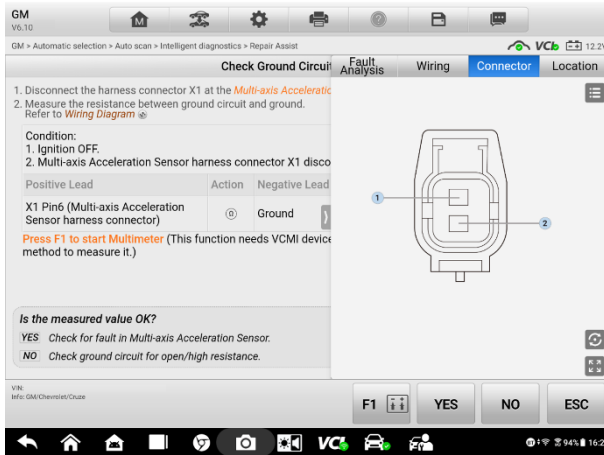

Figure 5-20 Repair Assist Screen 7

5.2.5 Repair Tips

The Repair Tips function displays a range of detailed diagnostics and repair information, including the information needed in order to clear the faults.

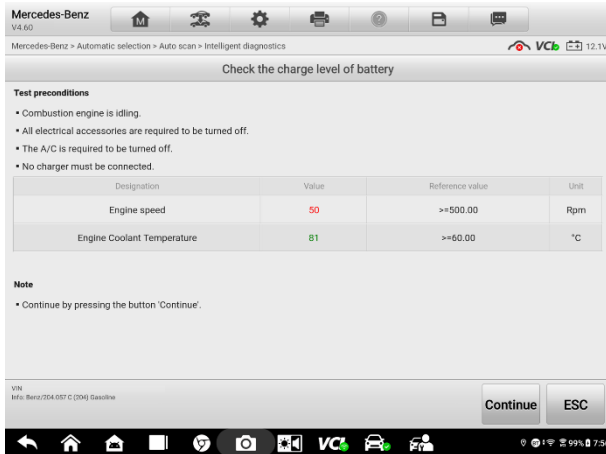

Figure 5-21 Repair Tips Description

5.2.6 Component Measurement

The component measurement section directs technicians to oscilloscope in one click. This section may include relevant waveforms and waveform analysis to aid the technician in diagnostics and repairs.

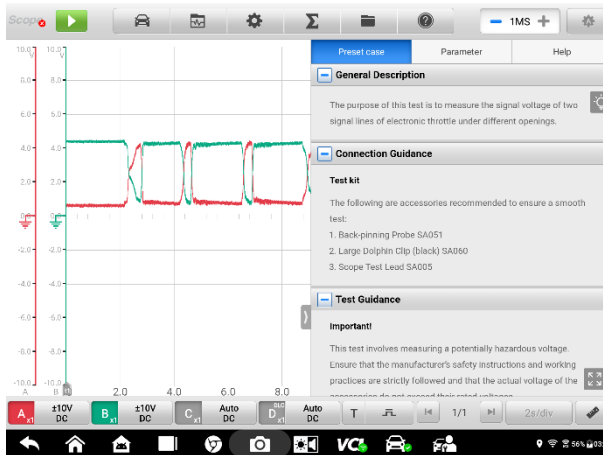

Figure 5-22 Component Measurement Screen

NOTE

To run the oscilloscope for measuring components, connect the tablet to a VCMi device. Connection to a VCI can only provide information on related waveforms and waveform analysis.

5.2.7 Relevant Cases

This section offers recommended repair cases that may be relevant to the current vehicle and/or the current fault. These repair cases may provide greater insight into diagnosing and repairing your vehicle. Tap any of the relevant cases to view.

➤ **To review relevant cases information**

1. Tap the **Relevant Cases** icon to display main page.
2. Scroll through the page and to locate relevant information.
3. Tap the arrow icon at the left top and return to the previous repair case page.

6. Service

The **Service** section is specially designed to provide quick access to the vehicle systems for various scheduled service and maintenance tasks. The typical service operation screen is a series of menu driven executive commands. Follow on-screen instructions to select appropriate execution options, enter correct values or data, and perform necessary actions. The application will display detailed instructions to complete selected service operations.

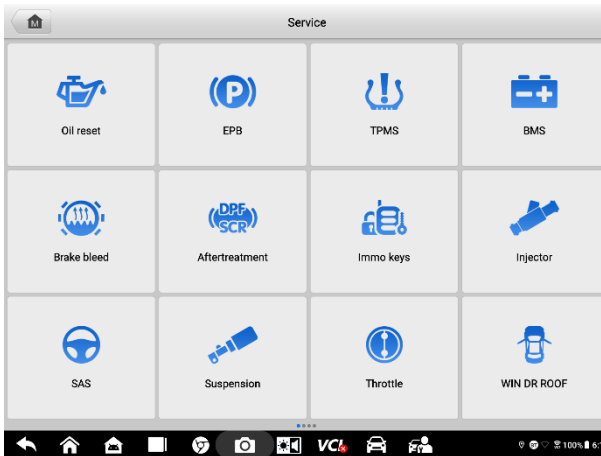

Figure 6-1 Service Menu

Several most commonly used services are described in this chapter.

6.1 Oil Reset Service

Perform reset for the Engine Oil Life system, which calculates an optimal oil life change interval depending on the vehicle driving conditions and climate. The Oil Life Reminder must be reset each time the oil is changed, so the system can calculate when the next oil change is required.

NOTE

1. Always reset the engine oil life to 100% after every oil change.
2. All required work must be carried out before the service indicators are reset. Failure to do so may result in incorrect service values and cause DTCs to be stored by the relevant control module.
3. For some vehicles, the scan tool can reset additional service lights such as maintenance cycle and service interval. On BMW vehicles for example, service resets include engine oil, spark plugs, front/rear brakes, coolant, particle filter, brake fluid, micro filter, vehicle inspection, exhaust emission inspection and vehicle checks.

6.2 Electric Parking Brake (EPB) Service

This function has a multitude of usages to maintain the electronic braking system safely and effectively. The applications include deactivating and activating the brake control system, assisting with brake fluid control, opening and closing brake pads, and setting brakes after disc or pad replacement.

6.2.1 EPB Safety

It can be dangerous to perform Electric Parking Brake (EPB) system maintenance, so before you begin the service work, please keep these rules in mind.

- ✓ Ensure that you are fully familiar with the braking system and its operation before commencing any work.
- ✓ The EPB control system may be required to be deactivated before carrying out any maintenance/diagnostic work on the brake system. This can be done from the tool menu.
- ✓ Only perform maintenance work when the vehicle is stationary and on level ground.
- ✓ Ensure that the EPB control system is reactivated after the maintenance work has been completed.

NOTE

Autel accepts no responsibility for any accident or injury arising from the maintenance of the Electric Parking Brake system.

6.3 Tire Pressure Monitoring System (TPMS) Service

This function allows you to quickly look up the tire sensor IDs from the vehicle ECU, as well as to perform TPMS replacement and reset procedures after tire sensors are replaced.

6.4 Battery Management System (BMS) Service

The Battery Management System (BMS) allows the tool to evaluate the battery charge state, monitor the close-circuit current, register the battery replacement, activate the rest state of the vehicle, and charge the battery via the diagnostic socket.

NOTE

1. This function is not supported by all vehicles.
 2. The sub functions and actual test screens of the BMS may vary by vehicle, please follow the on-screen instructions to make correct option selection.
-

The vehicle may use either a sealed lead-acid battery or an Absorbed Glass Mat (AGM) battery. Lead acid battery contains liquid sulphuric acid and can spill when overturned.

AGM battery (known as VRLA battery, valve regulated lead acid) also contains sulphuric acid, but the acid is contained in glass mats between terminal plates.

It is recommended that the replacement aftermarket battery has the same specifications, such as capacity and type, as the exiting battery. If the original battery is replaced with a different type of battery (e.g. a lead-acid battery is replaced with an AGM battery) or a battery with a different capacity (mAh), the vehicle may require reprogramming of the new battery type, in addition to, performing the battery reset. Consult the vehicle manual for additional vehicle-specific information.

6.5 Diesel Particle Filter (DPF) Service

The Diesel Particle Filter (DPF) function manages DPF regeneration, DPF component replacement teach-in and DPF teach-in after replacing the engine control unit.

The ECM monitors driving style and selects a suitable time to employ regeneration. Cars driven a lot at idling speed and low load will attempt to regenerate earlier than cars driven more with higher load and speed. For regeneration to take place, a prolonged high exhaust temperature must be obtained.

In the event of the car being driven in such a way that regeneration is not possible, i.e., frequent short journeys, a diagnostic trouble code will eventually be registered in addition to the DPF light and “Check Engine” indicators displaying. A service regeneration can be requested in the workshop using the diagnostic tool.

Before performing a forced DPF regeneration using the tool, check the following items:

- The fuel light is not on.
- No DPF-relevant faults are stored in system.
- The vehicle has the specified engine oil.
- The oil for diesel is not contaminated.

! IMPORTANT

Before diagnosing the problem vehicle and attempting to perform an emergency regeneration, it is important to obtain a full diagnostic log and read out relevant measured value blocks.

NOTE

1. The DPF will not regenerate if the engine management light is on, or there is a faulty EGR valve.
 2. The ECU must be re-adapted when replacing the DPF and when topping up the fuel additive Eolys.
 3. If the vehicle needs to be driven in order to perform a DPF service, a second person is needed for the function. One person should drive the vehicle while the other person observes the screen on the Tool. Do not attempt to drive and observe the scan tool at the same time. This is dangerous and puts your life and the lives of other motorists and pedestrians at risk.
-

6.6 Immobilizer (IMMO) Service

An immobilizer is an anti-theft mechanism that prevents an automobile's engine from starting unless the correct ignition key or other device is present. This device prevents thieves from starting the car by a method known as hot wiring. Most new vehicles have an immobilizer as standard equipment. An important advantage of this system is that it doesn't require the car owner to activate it; it operates automatically. An immobilizer is considered as providing much more effective anti-theft protection than an audible alarm alone; many auto insurance companies offer lower rates for vehicles that are equipped with an immobilizer.

As an anti-theft device, an immobilizer disables one of the systems needed to start a car's engine, usually the fuel supply or the ignition. This is accomplished by radio frequency identification between a transponder in the ignition key and a device called a radio frequency reader in the steering column. When the key is placed in the ignition, the transponder sends a signal with a unique identification code to the reader, which relays it to a receiver in the vehicle computer control module. If the code is correct, the computer allows the fuel supply and ignition systems to operate and start the car. If the code is incorrect or absent, the computer disables the system, and the car will be unable to start until the correct key is placed in the ignition.

The IMMO service can disable a lost vehicle key and program the replacement key fob. One or more replacement key fobs can be programmed.

6.7 Steering Angle Sensor (SAS) Service

SAS Calibration permanently stores the current steering wheel position as the straight-ahead position in the SAS EEPROM. Therefore, the front wheels and the steering wheel must be set exactly to the straight-ahead position before calibration. In addition, the VIN is also read from the instrument cluster and stored permanently in the SAS EEPROM. On successful completion of calibration, the SAS fault memory is automatically cleared.

Calibration must always be carried out after the following operations:

- Steering wheel replacement

- SAS replacement
- Any maintenance that involves opening the connector hub from the SAS to the column
- Any maintenance or repair work on the steering linkage, steering gear or other related mechanism
- Wheel alignment or wheel track adjustment
- Accident repairs where damage to the SAS or assembly, or any part of the steering system may have occurred

 **NOTE**

1. Autel accepts no responsibility for any accident or injury arising from servicing the SAS system. When interpreting DTCs retrieved from the vehicle, always follow the manufacturer's recommendation for repair.
 2. All software screens shown in this manual are examples, and actual test screens may vary by test vehicle. Pay attention to the menu titles and onscreen instructions to make correct option selections.
 3. Before starting procedure, make sure the vehicle has an ESC button. Look for button on dash.
-

7. ADAS

Advanced Driver Assistance Systems (ADAS) is an array of vehicle systems that aid the driver either through passive alerts or by active control of the vehicle to drive safer and with greater awareness and precision.

Cameras, sensors, ultrasound, radar and LIDAR are some of the systems used to capture the driving environment data, including travelling or static vehicles position, pedestrian location, road sign, driving lane and intersection detection, road (curves) and driving conditions (poor visibility or evening driving), use that information to instruct the vehicle to take its predetermined action. Cameras, sensors and sensing systems are typically located in front and rear bumpers, windshield, front grill and side and rear view mirrors.

Autel ADAS Calibration Tool provides comprehensive and precise ADAS calibration.

1. Covers many vehicle makes, including Benz, BMW, Audi, Volkswagen, Porsche, Infiniti, Lexus, GM, Ford, Volvo, Toyota, Nissan, Honda, Hyundai, and Kia.
2. Supports the calibration of multiple driver assistant systems, including Adaptive Cruise Control (ACC), Night Vision System (NVS), Lane Departure Warning (LDW), Blind Spot Detection (BSD), Around View Monitoring (AVM), Rear Collision Warning (RCW), and Heads-up Displays (HUD).
3. Supplies graphic illustrations and step-by-step instructions.
4. Provides demos to guide the technician through the calibration.

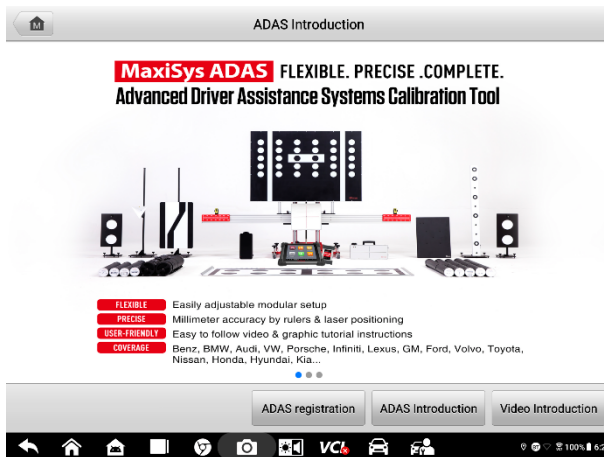

Figure 7-1 Autel ADAS Introduction Screen

8. Data Manager

The Data Manager application allows you to store, print and review the saved files, manage the workshop and customer information records, and keep test vehicle records.







Selecting the Data Manager application opens the file system menu. There are nine main functions available.





Figure 8-1 Data Manager Screen

The table below describes each of the Function Buttons in the Data Manager application.

Table 8-1 Buttons in Data Manager

Button	Name	Description
	Vehicle History	View the diagnostic records.
	Workshop Information	View or edit the workshop information.
	Customer	Create a new customer account file.
	Image	View or delete the screenshots.
	Report	View saved reports and share saved reports in the cloud.
	PDF	View the diagnostic reports.

Button	Name	Description
	Review Data	View the recorded data.
	Uninstall Apps	Uninstall applications.
	Data Logging	View communications with Autel support service and ECU information of the test vehicle. The saved data can be reported and sent to the technical center via the Internet.

8.1 Vehicle History

This function stores records of test vehicle, including vehicle information and the retrieved DTCs from previous diagnostic sessions. Test information is summarized and displays in an easy-to-read table listing. The Vehicle History also provides direct access to the previously-tested vehicles and allows you to directly restart a diagnostics session without needing to perform auto or manual vehicle selection.

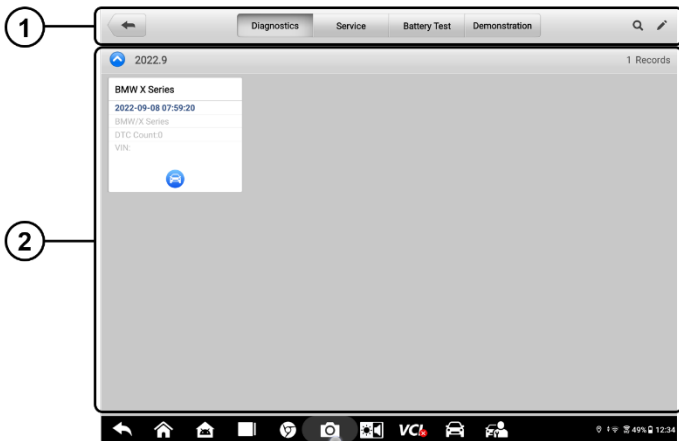

Figure 8-2 Vehicle History Screen

1. Top Toolbar Buttons — navigation and application controls.
 2. Main section — displays all vehicle records.
- **To activate a test session for the recorded vehicle**
1. Tap **Data Manager** on the MaxiSys Job Menu.
 2. Select **Vehicle History** to open the screen. Tap **Diagnostics**, **Battery Test** or **Service** to select the test records.
 3. Tap the icon at the bottom of the thumbnail of a vehicle record.

- The diagnostics screen of the vehicle appears and a new diagnostic session is activated. Or select a vehicle thumbnail to select a record. A History Test record sheet appears. Review the recorded information for the test vehicle, and tap the button on the upper-right corner to continue diagnostics.

8.1.1 Test Record

The Test Record is a detailed data form of the test vehicle, which includes general vehicle information, service record, and customer information. Technician Notes will also display if present.

NOTE

The MaxiSys tablet must connect to the VCI to restart test sessions on the previously tested vehicles.

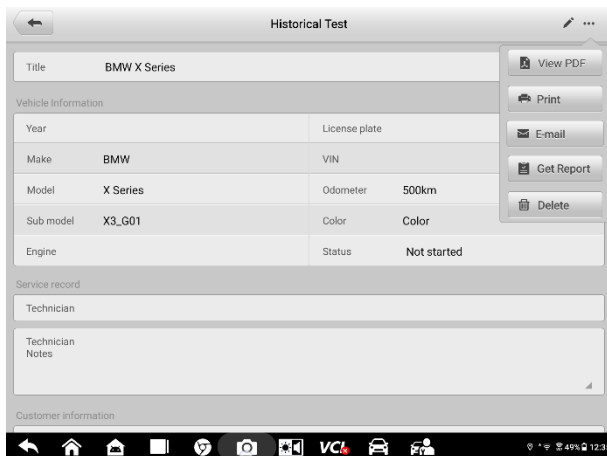

Vehicle Information			
Year	License plate		
Make	BMW	VIN	
Model	X Series	Odometer	500km
Sub model	X3_G01	Color	Color
Engine	Status Not started		

Service record

Technician

Technician Notes

Customer information

Figure 8-3 Test Record Sheet

➤ To edit the Test record

- Tap **Data Manager** from the MaxiSys Job Menu.
- Select **Vehicle History**.
- Select a specific vehicle history record thumbnail from the main section. The historical test record will display.
- Tap the **Edit** button (a pen icon) to start editing.
- Tap each item to input information or attach files or images.
- Tap **Add a Customer** to correlate the historical record sheet to an existing customer account, or add a new account to be correlated with the test vehicle record. See [Customer](#) for more information.

7. Tap **Done** to save the updated record, or tap **Cancel** to exit without saving.

NOTE

The vehicle VIN, license number, and customer account are correlated by default. Vehicle records will automatically be correlated using this vehicle and customer identification.

8.2 Workshop Information

Workshop Information allows you to input, edit, and save the detailed workshop information, such as shop name, address, phone number, and other remarks, which, when printing vehicle diagnostic reports and other associated test file, will display as the header of the printed documents.

Figure 8-4 Sample Workshop Information Sheet

➤ To edit the Workshop information sheet

1. Tap **Data Manager** from the MaxiSys Job Menu.
2. Select **Workshop Information**.
3. Tap on each field to input the corresponding information.
4. Tap **Done** to save the updated workshop information, or tap **Cancel** to exit without saving.

8.3 Customer

The Customer function allows you to create and edit customer accounts. It helps you to save and organize all customer accounts correlated with the test vehicle history records.

➤ **To create a customer account**

1. Tap the **Data Manager** application from the MaxiSys Job Menu.
2. Select **Customer**.
3. Tap the **Add a Customer** button. An empty information form displays, and tap each field to input the appropriate information.

 **NOTE**

The items that must be filled are indicated as required fields.

4. For customers with more than one vehicle for service, tap **Add New Vehicle Information**. To delete the added vehicle information, tap the  button.
5. Tap **Complete** in the upper-right corner of the screen to save the customer information, or tap **Cancel** to exit without saving.

➤ **To edit a customer account**

1. Tap **Data Manager** from the MaxiSys Job Menu.
2. Select **Customer**.
3. Select a customer account by tapping the corresponding name card. A Customer Information record displays.
4. Tap **Edit** on the top toolbar to start editing.
5. Tap on the input field to edit information, and enter the updated information.
6. Tap **Complete** to save the updated information, or tap **Cancel** to exit without saving.

➤ **To delete a customer account**

1. Tap **Data Manager** from the MaxiSys Job Menu.
2. Select **Customer**.
3. Select a customer account by tapping the corresponding name card. A Customer Information record displays.
4. Tap **Edit** on the top toolbar to start editing.
5. Tap **Delete** button on the top of the screen. A message displays.
6. Tap **OK** to confirm the command, and the account is deleted. Tap **Cancel** to cancel the request.

8.4 Image

The Image section is a PNG database containing all captured screenshots.

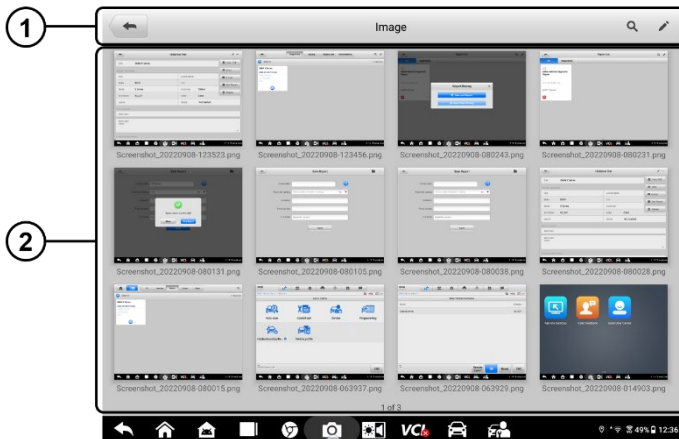

Figure 8-5 Image Database Screen

1. **Toolbar Buttons** — used to edit, print or delete the image files. See [Table 8-2 Toolbar Buttons in PNG Database](#) for detailed information.
2. **Main Section** — displays the stored images.

Table 8-2 Toolbar Buttons in PNG Database

Name	Button	Description
Back		Returns to the previous screen.
Search		Tap to enter the search page.
Edit		Tap to display the editing toolbar to print, delete or view image.
Cancel		Tap to close the editing toolbar or cancel file search.
Search		Quickly searches the image by entering the time of the screenshot.
Print		Tap to print the selected image.
Delete		Tap to delete the selected image.
Email		Tap to send the selected image to an email.

➤ **To edit/delete image(s)**

1. Select **Data Manager** from the MaxiSys Job Menu.
2. Select **Image** to access the PNG database.
3. Tap **Edit** on the top-right corner of the window. The editing screen displays.

4. Select the image(s) you want to edit by tapping the check box at the bottom-right corner of the image.
5. Tap **Delete** icon to delete the selected images or delete all images. Tap **Print** icon to print the selected image(s). Tap **Email** icon to send the selected image(s) to an email.

8.5 Report

The Report section stores diagnostics reports. You can view local reports or share the report to the Autel cloud after entering the report database and selecting a specific report.

8.6 PDF Files

The PDF section stores and displays all PDF files of saved data. After entering the PDF database, select a PDF file to view the stored information.

This section uses the standard Adobe Reader application for file viewing and editing. Please refer to the associated Adobe Reader manual for more detailed instructions.

8.7 Review Data

The Review Data function allows you to play back the recorded data frames of live data streams.

On the Review Data main screen, select a record to play back.

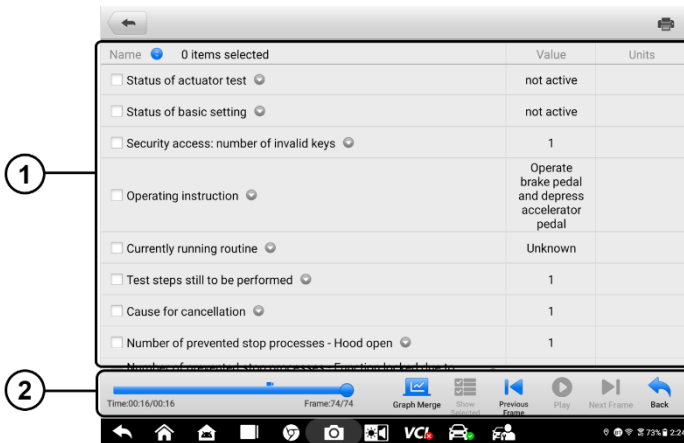

Figure 8-6 Data Playback Screen

1. Main Section — displays the recorded data frames.
2. Navigation Toolbar — allows you to manipulate data playback.

Use the Navigation Toolbar buttons to play back the record data from frame to frame.

Tap **Back** to exit data playback.

8.8 Uninstall Apps

This section allows you to manage the software application installed on the MaxiSys Diagnostics System. Selecting this section opens a managing screen, on which you can check all available vehicle diagnostic applications.

Select the vehicle software you want to delete by tapping on the car brand icon, the selected item will display a blue check mark at the upper-right corner. Tap the **Delete** button on the top bar to delete the software from the system database.

8.9 Data Logging

The Data Logging section allows you to launch the Support platform directly to view all records of all feedback or not feedback (saved) data loggings on the diagnostics system. For more information, please refer to [Data Logging](#).

9. Battery Test

The MaxiBAS BT506 is a battery and electrical system analysis tool that uses Adaptive Conductance, an advanced battery analysis method to produce a more accurate examination of the battery's cold cranking ability and reserve capacity, which is vital to determining a battery's true health. The MaxiBAS BT506 enables technicians to view the health status of the vehicle's battery and electrical system. Together with the MaxiBAS BT506, this application can complete battery & starting and charging system tests and display the test results.

NOTE

The MaxiBAS BT506 tester is sold separately.

9.1 MaxiBAS BT506 Tester

9.1.1 Function Description

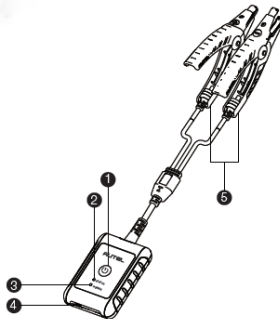

Figure 9-1 *MaxiBAS BT506 Tester*

- ❶ Power Button
- ❷ Status LED
- ❸ Power LED
- ❹ USB Port
- ❺ Battery Clamp Cable

Table 9-1 LED Description

LED	Color	Description
Status LED	Flashing Green	The tester is communicating via USB cable.
	Flashing Blue	The tester is communicating via Bluetooth.
	Flashing Red	Battery clamps are connected to the wrong battery terminals.
Power LED	Solid Green	The tester is powered on and the battery is sufficiently charged.
	Flashing Green	The tester is charging. (Becomes solid green when battery is fully charged.)
	Solid Red	The device is in boot mode.
	Flashing Red	The battery level is low. Please charge.

9.1.2 Power Sources

The MaxiBAS BT506 tester can receive power from the following sources:

- Internal Battery Pack
- AC/DC Power Supply

! IMPORTANT

Do not charge the battery when the temperature is below 0 °C (32 °F) or above 45 °C (113 °F).

Internal Battery Pack

The MaxiBAS BT506 tester can be powered with the internal rechargeable battery.

AC/DC Power Supply — Using Power Adapter

The MaxiBAS BT506 tester can be powered from an electrical outlet using the AC/DC power adapter. The AC/DC power supply also charges the internal battery pack.

9.1.3 Technical Specifications

Table 9-2 *Technical specifications*

Item	Description
Connectivity	<ul style="list-style-type: none">● USB 2.0, type C● Bluetooth 4.2
Input Voltage	5 V DC
Working Current	< 150 mA at 12 V DC
Internal Battery	3.7 V/800 mAh Lithium-ion polymer battery
CCA Range	100 to 2000 A
Voltage Range	1.5 to 16 V
Working Temperature	-10 °C to 50 °C (14 °F to 122 °F)
Storage Temperature	-20 °C to 60 °C (-4 °F to 140 °F)
Dimension (L x W x H)	107 mm (4.21") x 75 mm (2.95") x 26 mm (1.02") (clamp cable not included)
Weight	320 g (0.7 lb.)

9.2 Test Preparation

9.2.1 Inspect the Battery

Before starting a test, observe the battery for:

- Cracking, buckling or leaking (If you see any of these defects, replace the battery.)
- Corroded, loose or damaged cables and connections (Repair or replace as needed.)
- Corrosion on the battery terminals, and dirt or acid on the case top (Clean the case and terminals using a wire brush and a mixture of water and baking soda.)

9.2.2 Connect the Battery Tester

➤ **To pair the BT506 with the MaxiSys tablet**

1. Press and hold the **Power** button to turn on both the MaxiSys tablet and BT506. Ensure that the unit is sufficiently charged before using.
2. Enable **Bluetooth** on the MaxiSys tablet by tapping **VCI Manager > BAS BT**, and the tablet automatically scans for an available tester for Bluetooth pairing. The device name will appear as "Maxi" suffixed with the device serial number.
3. Check the serial number of your BT506 tester and select the desired device for pairing.

- When paired successfully, the connection status will read as “**Connected**” and the status LED will flash blue.

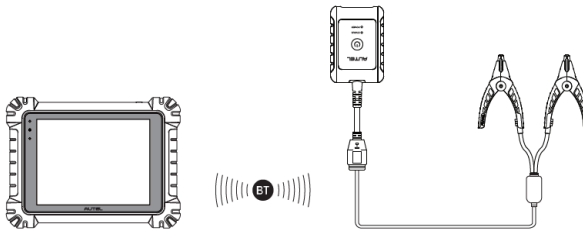

Figure 9-2 Connecting with the Tablet

➤ **To connect to a battery**

Connect the red clamp to the positive (+) terminal and the black clamp to the negative (-) terminal of the battery.

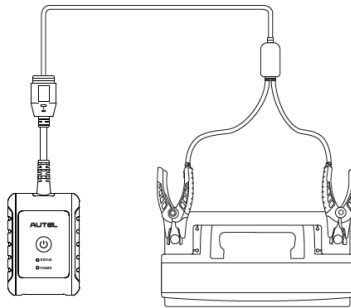

Figure 9-3 Connecting to a Battery

9.3 In-vehicle Test

In-vehicle Test is used for testing batteries that are installed in a vehicle. An in-vehicle test includes Battery Test, Starter Test, and Generator Test. These tests help determine the health status of the battery, the starter, and the generator.

NOTE

The complete in-vehicle test includes battery test, starter test, and generator test, in sequence.

IMPORTANT

Before using the diagnostics functions, download the desired vehicle software on the Update screen.

➤ **Confirm the Vehicle Information**

1. Tap the **Battery Test** application on the MaxiSys Job Menu. Select **In-vehicle Test**.
2. Confirm your vehicle information and make sure the VIN information is filled.
3. Confirm your battery information, including voltage, type, standard, and capacity. Tap **Next** to continue.

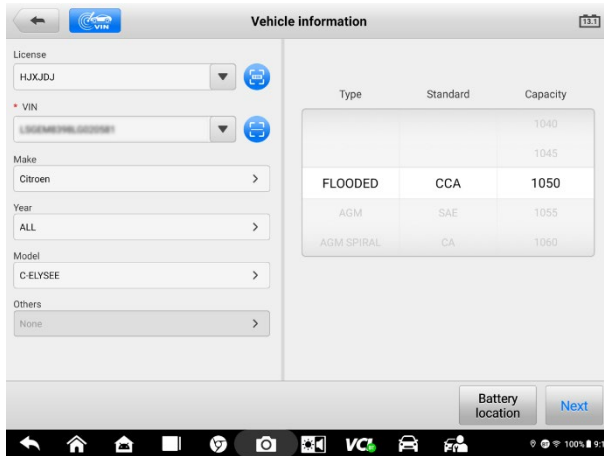







Figure 9-4 Vehicle Information Screen

Please refer to the table below for a list of buttons that may appear when accessing the functions:

Table 9-3 Top Toolbar Buttons

Name	Buttons and Icons	Description
Battery Connection		The value on the icon indicates the real-time voltage of the tested battery. In the battery test, the icon will turn green if the battery is good; otherwise, it will turn red.
Next		Tap to proceed.
Home		Returns to the MaxiSys Job Menu.
Back		Returns to the previous screen.
Exit		Returns to the Job Menu.

9.3.1 Battery Test

➤ To perform the battery test

1. Tap **Next** on the Vehicle Information screen (Figure 9-4). Follow the on-screen instructions. Check the boxes once all required tasks are completed, and tap **Start Testing**.

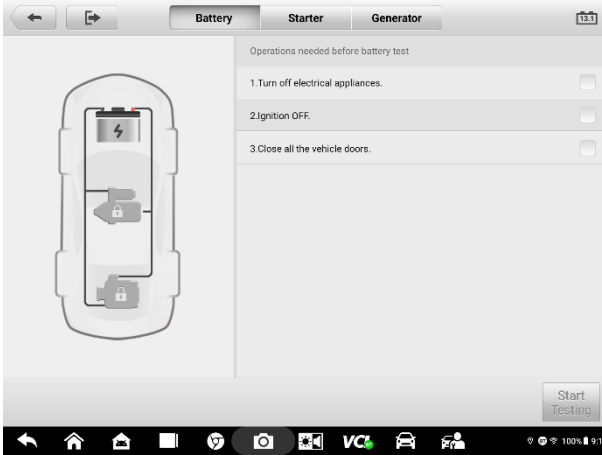

Figure 9-5 Battery Test Screen

2. Wait until the test is completed. The test results will be displayed on the tool.



Figure 9-6 Battery Test Results Screen

Battery Test Results

The battery test results include a color-coded results summary, a list of test data, and repair tips.

Table 9-4 Test Results

Result	Repair Tip
Good Battery	Battery is good.
Good & Recharge	Battery is good but insufficiently charged. Recharge the battery.
Charge & Retest	Battery requires charge to determine its condition.
Bad Cell	Replace the battery.
Replace Battery	Replace the battery.

 **NOTE**

Please always complete the battery test before you proceed to the starter and generator tests.

9.3.2 Starter Test

➤ **To perform the starter test**

1. Tap **Continue** on the Battery Test Results screen. Perform required operations based on the on-screen instructions. Tap the **Start Testing** button.
2. Start the engine and let it idle.
3. Wait for the test to complete and view the test results.

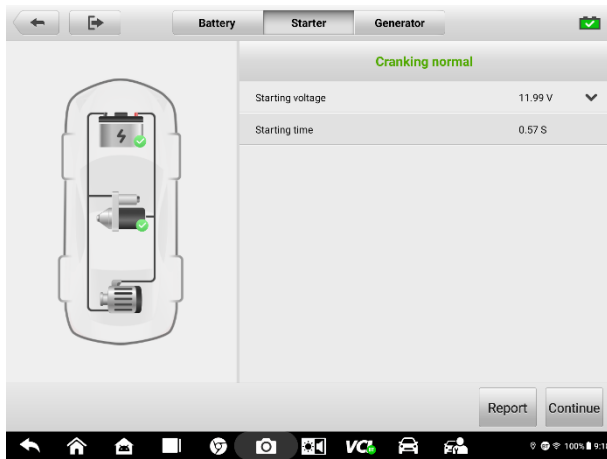

Figure 9-7 Starter Test Results Screen

Table 9-5 Starter Test Results

Result	Description
Cranking Normal	The starter is good.
Current Too Low	Low momentary discharge capacity.
Voltage Too Low	Low battery storage capacity.
Not Started	The starter is not detected for starting.

9.3.3 Generator Test

➤ **To perform the generator test**

1. Tap **Continue** on the Starter Test Results screen. Perform required operations based on the on-screen instructions.
2. Tap **Continue** at the bottom of the screen to view the test results.
3. Tap the **Done** button to finish the in-vehicle test.

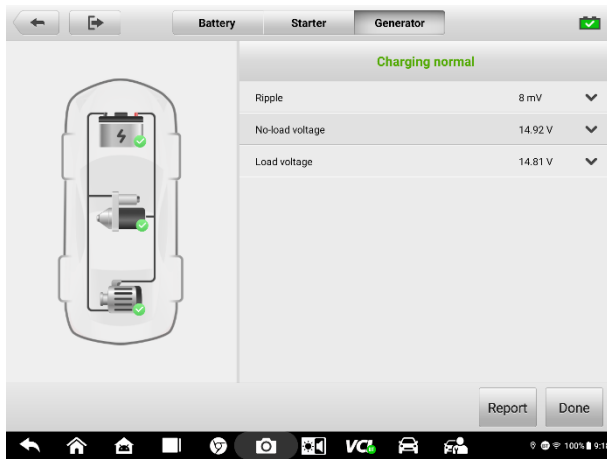

Figure 9-8 Generator Test Results Screen

Table 9-6 Generator Test Results

Result	Description
Charging Normal	The generator is functioning normally.
Output Too Low	<ul style="list-style-type: none"> ● The belt linking the starter and the generator is loose. ● The cable linking the starter and battery is loose or corroded.
Output Too High	<ul style="list-style-type: none"> ● The generator is not properly connected to the ground. ● The voltage adjuster is broken and needs replacement.
Ripple Too Large	The commutation diode is broken.
No Output	<ul style="list-style-type: none"> ● The cable is loose. ● Some vehicles with power management systems do not provide path for charging due to the sufficient load capacity of the battery. ● The generator or the voltage adjuster is broken and needs replacement.

9.4 Out-vehicle Test

Out-vehicle test is used to test the condition of batteries that are not connected to a vehicle. This function aims to check the health status of the battery only. The battery types and standards able to be tested are as follows.

Types: FLOODED, AGM, AGM SPIRAL, EFB, and GEL

9.4.1 Test Procedure

➤ **To perform the out-vehicle test**

1. Tap the **Battery Test** application on the MaxiSys Job Menu. Select **Out-vehicle Test**.
2. Connect the tester clamps to the battery terminals.
3. Check the battery information. Tap **Start Testing** to start the test.

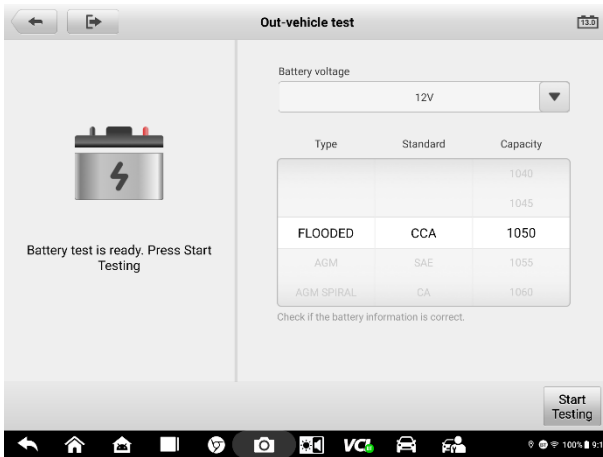

Table 9-7 Out-vehicle Test Screen

4. The test results will display in a few seconds.



Table 9-8 Out-vehicle Test Results Screen

9.4.2 Test Results

Icons are color-coded to indicate status.

Table 9-9 Out-vehicle Test Results

Result	Description
Good Battery	Battery meets required standards.
Good & Recharge	Battery is good, but low on charge. Fully charge the battery. Check for causes of low charge.
Charge & Retest	Battery requires charge to determine its condition.
Replace Battery	Battery fails to meet industry-accepted standards.
Bad Cell	Battery fails to meet industry-accepted standards.

10. Settings

Access the Settings menu to adjust default settings and view information about the MaxiSys system. The following options are available for the MaxiSys system settings:

- Units
- Language
- Printing Settings
- Report Settings
- Auto Update
- ADAS Settings
- Vehicle List
- EVDiag Box Settings
- Country/Region Code
- System Settings
- About

10.1 Operations

This section describes the operation procedures for the settings.

10.1.1 Units

This option allows you to change the measurement unit for the diagnostics system.

➤ **To change the unit setting**

1. Tap the **Settings** application on the MaxiSys Job Menu.
2. Tap the **Units** option on the left column.
3. Select the appropriate measurement units (metric or imperial). A check mark appears to the right of the active selection.
4. Tap the **Home** button on the top-left corner to return to the MaxiSys Job Menu. Or select another settings option for the system setup.

10.1.2 Language

This option allows you to change the display language for the MaxiSys system.

➤ To adjust the language setting

1. Tap the **Settings** application on the MaxiSys Job Menu.
2. Tap the **Language** option on the left column.
3. Select the appropriate language. A check mark displays to the right of the selected language.
4. Tap the **Home** button on the top-left corner to return to the MaxiSys Job Menu. Or select another settings option for the system setup.

10.1.3 Printing Settings

Printing Settings

This option allows you to print from the tablet to a network printer via a computer.

➤ To setup the printer connection

1. Tap **Settings** on the MaxiSys Job Menu.
2. Tap **Printing Settings** on the left column.
3. Select **Print via PC-Link** or **Print via Wi-Fi** to confirm the print method. A check mark will display to the right of the selected item.
4. Tap **Home** on the top-left corner to return to the MaxiSys Job Menu. Or select another settings option for the system setup.

Printing Operations

➤ To install the MaxiSys Printer driver program

1. Download **Maxi PC Suite** from www.autel.com > *Support* > *Downloads* > *Autel Update Tools*, and install to your Windows-based PC.
2. Double-click on **Setup.exe**.
3. Select an installation language and the wizard will load.
4. Follow the instructions on the screen and click on **Next** to continue.
5. Click **Install** and the printer driver program will be installed onto the computer.
6. Click **Finish** to complete the installation.

This section describes how to receive files from the MaxiSys tablet and perform printing through the computer.

 **NOTE**

Make sure the computer installed with the MaxiSys Printer driver program is connected to a printer.

➤ **To perform printing through the computer**

1. Run the **PC Link** program on the computer.
2. Click **Test Print** to check whether the printer works properly.
3. Tap the **Print** button on the toolbar of the tablet. A test document will be sent to the computer.
 - If the **Auto Print** option in the MaxiSys Printer is selected, the MaxiSys printer will automatically print the received document.
 - If the **Auto Print** option in the MaxiSys Printer is not selected, click the **Open PDF File** button to view files. Select the file(s) to be printed and click **Print**.

10.1.4 Report Settings

This option automatically synchronizes the diagnostics information of the vehicle to the vehicle history and forms a diagnostics report for the user to upload. Tap the **ON/OFF** button to enable/disable the **Scan Report** and **Report Upload to Cloud** functions. The buttons appear blue if the function is enabled and grey if the function is disabled.

10.1.5 Auto Update

This option allows you to preset a time to update the software. There are three update options: OS Update, MaxiSys Update, and Vehicle Update.

Tap **ON/OFF** to enable/disable Auto Update. The button displays blue if Autel Update is enabled and displays grey if the Auto Update is disabled. Set the time of the day for updating. If a specific time is set, the selected software will be automatically updated at this specific time.

10.1.6 ADAS Settings

➤ **To activate MaxiSys ADAS Calibration**

1. Confirm that updates for the registered MaxiSys tablet are available.
2. Select **Settings** on the MaxiSys Job Menu.
3. Click on **ADAS Registration**.

4. Scan the QR code on the ADAS frame to bind, or manually input frame serial number when QR code is not available.
5. Enter the verification code from the ADAS Calibration Card.
6. The system will reset and the MaxiSys Job Menu screen will display once registration has been completed.

10.1.7 Vehicle List

This option allows you to sort the vehicles either by alphabetic order or by frequency of use.

➤ **To adjust the vehicle list setting**

1. Tap the **Settings** application on the MaxiSys Job Menu.
2. Select **Vehicle List** on the left column.
3. Select the required sort type. A check mark will display to the right of the selected item.
4. Tap the **Home** button in the top-left corner to return to the MaxiSys Job Menu. Or select another settings option for system setup.

10.1.8 EVDiag Box Settings

When the EVDiag Box device is linked with the MS909, this MaxiSys diagnostics system can support the battery pack test function.

➤ **To link the EVDiag Box device**

1. Tap the **Settings** application on the MaxiSys Job Menu.
2. Tap the **EVDiag Box Settings** option on the left column.
3. Connect the EVDiag Box according to the on-screen connection diagram.
4. Tap **Read** to automatically acquire the EVDiag Box serial number and tap **Link EVDiag Box**.
5. Restart your tablet to automatically download the Battery Pack Test software.

10.1.9 Country/Region Code

This function provides Wi-Fi channel options for different countries and regions to ensure reliable and stable Wi-Fi communication. Please connect the tablet with a VCI before making adjustment.

➤ **To adjust the country/region code setting**

1. Tap the **Settings** application on the MaxiSys Job Menu.
2. Tap the **Country/Region Code** option on the left column.
3. Select the appropriate country or region. A message displays to confirm your selection.
4. Tap the **Home** button on the top-left corner to return to the MaxiSys Job Menu. Or select another settings option for the system setup.

🔗 **NOTE**

If the tablet can NOT find the VCI via Wi-Fi connection after setting the country code, please use the USB or Bluetooth connection to retry.

10.1.10 System Settings

This function provides you with direct access to the Android system setting interface, where you can adjust various system settings for the Android system platform, regarding wireless and networks settings, various device settings such as sound and display, as well as system security settings, and check related information about the Android system. Refer to Android documentation for additional information.

10.1.11 About

The About function provides information of the MS909, including the product name, version, hardware, and serial number.

➤ **To check the MaxiSys product information in About**

1. Tap the **Settings** application on the MaxiSys Job Menu.
2. Select the **About** option on the left column. The product information displays on the right.
3. Tap the **Home** button on the top-left corner to return to the MaxiSys Job Menu, or select another settings option for the system setup.

11. Update

The Update application allows you to download the latest software. The updates can improve the MaxiSys applications' capabilities, typically by adding new tests, new vehicle models or enhanced applications.

This section describes the update operations for the MaxiSys tablet. The tablet automatically searches for available updates for all of the MaxiSys software when it is connected to the Internet. Any updates that are found can be downloaded and installed on the tablet with a stable Internet connection.

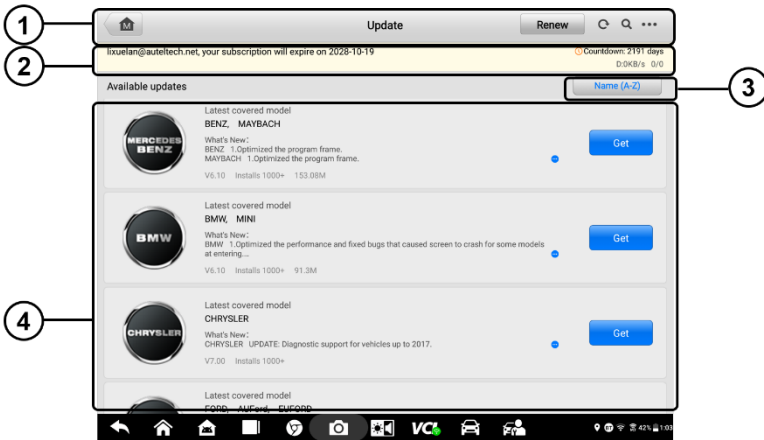

Figure 11-1 Update Screen

1. Navigation and Controls

- Home — returns to the MaxiSys Job Menu.
- Renew — renews the subscription.
- Refresh — refreshes the interface.
- Search — searches specific update item by entering the file name, for example: a vehicle make

2. Status Bar

- Left Side — displays the account information and the validity period of subscription.
- Right Side — displays the countdown for validity period of subscription; displays the download speed and update progress which indicates the completion status.

3. Function Button

- Name (A-Z) — tap to change the sort order of available updates. There are 5 ways to view updates: Date (Old to New), Date (New to Old), Frequency, Name

(A–Z), and Name (Z–A).

4. Main Section

- Left Column — displays vehicle icons.
- Middle Column — displays a brief introduction about the new changes to the software operation or capabilities. Tap the  button to open an information screen to view more details, and tap the dim area around to close the window.
- Right Column — according to the operation status of each software item, the button displays differently.
 - a) Tap **Get** to update the selected item.
 - b) Tap **Pause** to suspend the updating procedure.
 - c) Tap **Continue** to continue updating the suspended update.

➤ To update the software

1. Ensure the tablet is connected to a power source and has a stable Internet connection.
2. Tap the **Update** application from the MaxiSys Job Menu screen. The Update screen displays.
3. Check all available updates. If you only want to update one or some of the items, tap the **Get** button on the right column of the specific items.
4. Tap the **Pause** button to suspend the updating process. Tap **Continue** to resume updating and the process will continue from where it left off.
5. When the update process is completed, the software will be installed automatically. The previous version will be replaced.

12. VCI Manager

VCI Manager is for connecting the MaxiSys MS909 tablet with a VCI through Wi-Fi or Bluetooth. This application allows you to pair the tablet with the VCI or battery tester BT506 and to check their communication status.

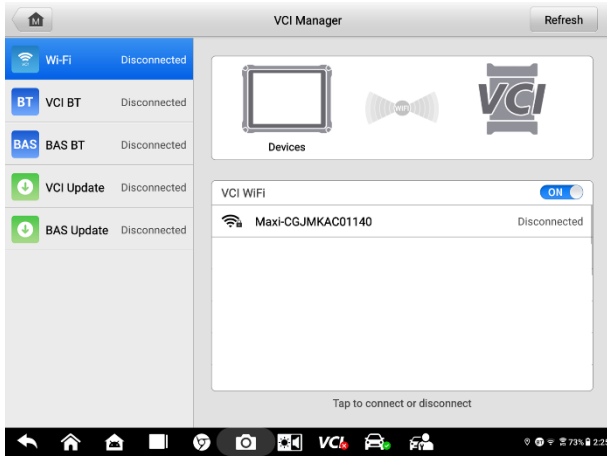

Figure 12-1 VCI Manager Screen

12.1 Wi-Fi Connection

Wi-Fi Connection is an advanced function for quick linkage with VCI. Since Wi-Fi connection supports 5G, the MaxiSys MS909 tablet and VCI share a faster and more stable connection when using this communication method. The tablet can be operated up to 50 meters away from the VCI when connected to the vehicle.

NOTE

To ensure quick connection, please perform this operation in a steady network environment.

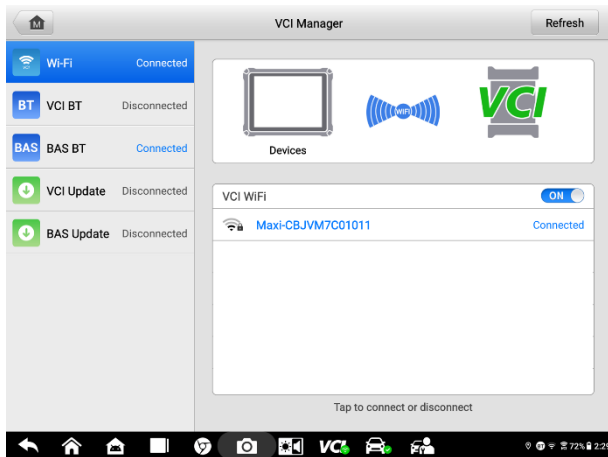

Figure 12-2 Wi-Fi Connection Screen

➤ **To connect the VCI with the tablet via Wi-Fi connection**

1. Power on the tablet.
2. Connect the 26-pin end of the main cable to the VCI's vehicle data connector.
3. Connect the 16-pin end of the main cable to the vehicle Data Link Connector (DLC).
4. Tap **VCI Manager** on the MaxiSys Job Menu of the tablet.
5. Select **Wi-Fi** from the connection mode list. Tap the VCI Wi-Fi toggle to turn it **ON**. The device will automatically start to search for available units.

NOTE

If no VCI is found, this may indicate that the signal strength is too weak to be detected. Reposition the VCI and remove all possible objects that may cause signal interference. Tap the **Refresh** button at the top-right corner to rescan for the VCI.

6. Depending on the VCI type you use, the device name may display as “Maxi” suffixed with a serial number. Select the appropriate device for connection. (If more than one VCI is used in the shop, ensure the correct VCI is selected to pair.)
7. When connection is established, the connection status reads “Connected.”
8. The VCI button on the system navigation bar at the bottom of the screen displays a green Wi-Fi icon, indicating the tablet is connected to the VCI.

12.2 VCI Bluetooth Pairing

Bluetooth pairing is the basic way for wireless connection. The VCI needs to be either connected to a vehicle or to an available power source, so that it is powered up during the synchronization procedure. Make sure the tablet has a charged battery or is connected to an AC/DC power supply.

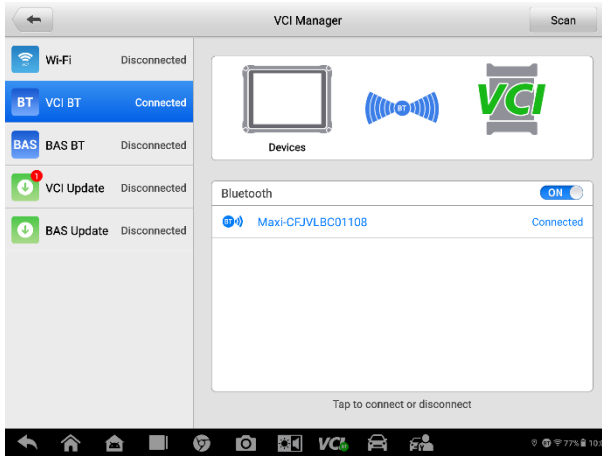

Figure 12-3 VCI Bluetooth Pairing Screen

➤ To pair the VCI with the tablet

1. Power on the tablet.
2. Connect the 26-pin end of the main cable to the VCI's vehicle data connector.
3. Connect the 16-pin end of the main cable to the vehicle data link connector (DLC).
4. Tap **VCI Manager** on the MaxiSys Job Menu of the tablet.
5. Select **VCI BT** from the connection mode list. Tap the Bluetooth toggle to turn it **ON**. The device automatically scans for VCIs available for Bluetooth pairing. Available VCIs are listed on the right side of the screen.
6. Depending on the VCI type you use, the device name may display as “Maxi” suffixed with a serial number. Select the required device for pairing.
7. When paired successfully, the connection status reads “Connected.”
8. The VCI button on the system navigation bar at the bottom of the screen displays a green circle BT icon, indicating the tablet is connected to the VCI.

📌 NOTE

A VCI can be paired to only one tablet at a time and once it has been paired, the device will not be discovered by any other unit.

12.3 BAS Bluetooth Pairing

The MaxiBAS BT506 device needs to be either connected to a vehicle or to an available power source, so that it is powered up during the synchronization procedure. Make sure the tablet is fully charged or is connected to an external power supply.

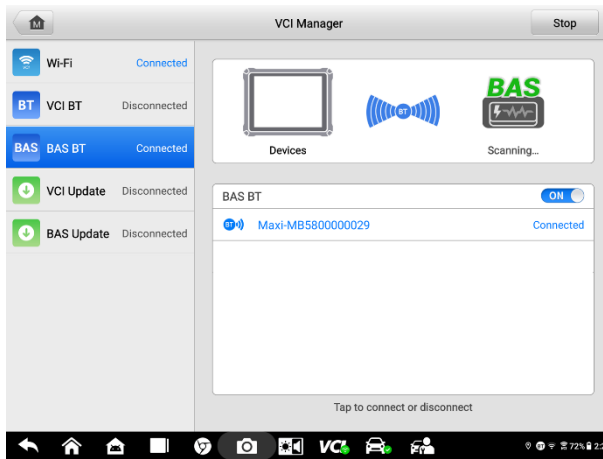

Figure 12-4 Battery Tester Bluetooth Pairing Screen

- **To pair the BT506 battery tester with the tablet**
 1. Turn on both the MaxiBAS BT506 and MS909 tablet.
 2. Tap the **VCI Manager** application on the MaxiSys Job Menu.
 3. Select **BAS BT** from the connection mode list. Tap the BAS Bluetooth toggle to turn it **ON**. The tablet automatically scans for an available battery tester for Bluetooth pairing. The device name will appear as “Maxi” suffixed with a serial number.
 4. Check the serial number of your BT506 tester and select the desired device on the tablet for pairing.
 5. When paired successfully, the connection status reads “Connected.”

12.4 VCI Update

The Update application provides the latest VCI update through the MaxiSys MS909 tablet. Before updating the VCI, please make sure the tablet network is stable.

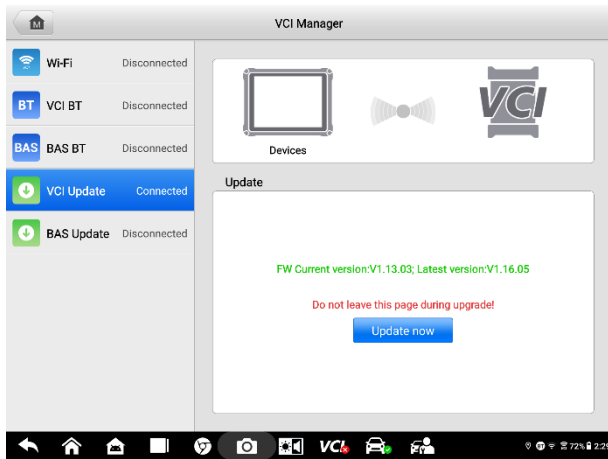

Figure 12-5 VCI Update Screen

➤ **To update the VCI**

1. Power on the tablet.
2. Connect the VCI to the tablet via USB cable or Bluetooth.
3. Tap **VCI Manager** on the MaxiSys Job Menu of the tablet.
4. Select **VCI Update** from the connection mode list.
5. The current version and the latest version of the VCI will display. Tap **Update Now** to update the VCI.

12.5 BAS Update

The Update application provides the latest BT506 update through the MaxiSys MS909 tablet. Before updating the BT506, please make sure the tablet network is stable.

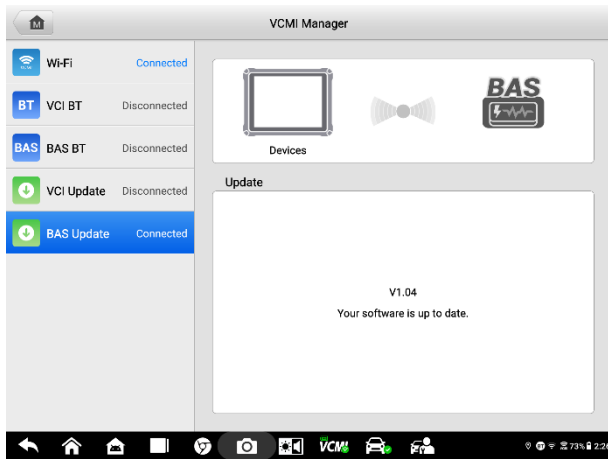

Figure 12-6 BAS Update Screen

➤ **To update the MaxiBAS BT506**

1. Power on the tablet and the MaxiBAS BT506.
2. Connect the MaxiBAS BT506 device to the tablet via Bluetooth or USB cable.
3. Tap **VCI Manager** on the MaxiSys Job Menu of the tablet.
4. Select **BAS Update** from the connection mode list.
5. The current version and the latest version of the MaxiBAS BT506 will appear. Tap **Update Now** to update the MaxiBAS BT506.

13. Support

This application launches the Support platform which synchronizes Autel's online service base station with the MaxiSys tablet. In order to synchronize the device to your online account, you need to register the product through the Internet when you use it for the first time. The Support application is connected to Autel's service channel and online communities that provides the quickest way for problem solutions, allowing you to submit complaints or send help requests to obtain direct service and support.

13.1 Product Registration

In order to get access to the Support platform and obtain update and other services from Autel, you are required to complete the product registration the first time you use it. There are two ways for registration:

A. Register your account and link the MS909 using the tablet

➤ **To register your account and link the MaxiSys tablet**

1. Tap **Autel User Center** from the MaxiSys Job Menu screen. The Log In screen appears.

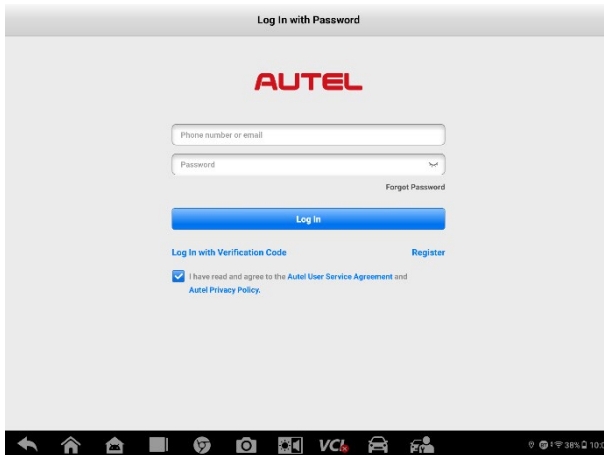

Figure 13-1 Autel User Center Screen

2. If you have an Autel account, log in with your account ID and password. Or you can log in with your phone number by tapping **Log In with Verification Code**.
3. If you are a new member to Autel, click on the **Register** button on the right side to create an ID.

4. Enter your personal information. Fields marked with an asterisk (*) are mandatory.
5. Read the **Autel User Service Agreement** and **Autel Privacy Policy**, then check the box to accept the terms.
6. After all the mandatory information is entered, click **Register**.
7. Once your account is successfully registered, your account will be logged in automatically.
8. Tap **Device Management** to link your device. Tap **Link Device** on the upper-right corner of the screen.
9. The serial number and password of the device will be shown on the screen. Tap **Link** to complete the operation.

B. Register the MS909 on the website

➤ **To register the diagnostic device**

1. Visit the website: <http://pro.autel.com>.
2. If you have an Autel account, log in and skip to Step 7.
3. If you are a new member to Autel, click **Register** to create your Autel ID.
4. Enter your personal information. Fields marked with an asterisk (*) are mandatory.
5. After all the mandatory information is entered, read the **Autel User Service Agreement** and **Autel Privacy Policy**, then check the box to accept the terms and click **Register**.
6. Once your account is successfully registered, you will be redirected to the Product Registration screen. If not, click the button on the screen.
7. Your product serial number and password are required to enter. To find your serial number and password on the tablet: go to **Settings** > **About**.
8. Enter your tablet's serial number and password.
9. Enter the CAPTCHA code and click **Submit** to complete your product registration.

13.2 Support Screen Layout

The Support application interface is navigated by the **Home** button on the top navigation bar.

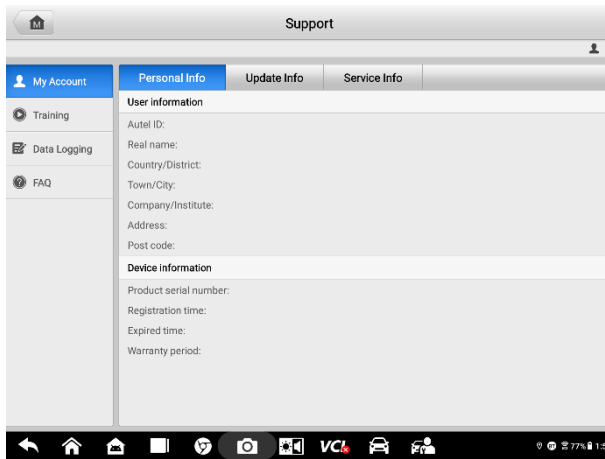

Figure 13-2 Support Application Screen

The main section of the Support screen is divided into two sections. The narrow column on the left is the main menu; selecting one subject from the main menu displays the corresponding functional interface on the right.

13.3 My Account

The My Account screen displays the comprehensive information of the user and the product, which is synchronized with the online registered account, including User Info, Device Info, Update Info, and Service Info.

13.3.1 Personal Info

The User Info and Device Info are both included under the Personal Info section.

- User Info — displays detailed information of your registered online Autel account, such as your Autel ID, Name, Address, and other contact information.
- Device Info — displays the registered product information, including the Serial Number, Registration Date, Expire Date, and Warranty Period.

13.3.2 Update Info

The Update Info section displays a detailed list of the product's software update history, including the product serial number, software version or name, and the update time.

13.3.3 Service Info

The Service Info section displays a detailed record list of the device's service history information. Every time the device has been sent back to Autel for repair, the device's

serial number and the detailed repair information, such as the fault type, changed components, or system reinstallation will be recorded and updated to the associated online product account that will be synchronized to the Service Info section.

13.4 Data Logging

The Data Logging section keeps records of all **Feedback** (submitted), **Not Feedback** (but saved) or **History** (up to the latest 20 test records) data loggings on the diagnostics system. The support personnel will receive and process the submitted reports through the Support platform. The solution will be sent back within 48 hours. You may continue to correspond with Support until the issue is resolved.

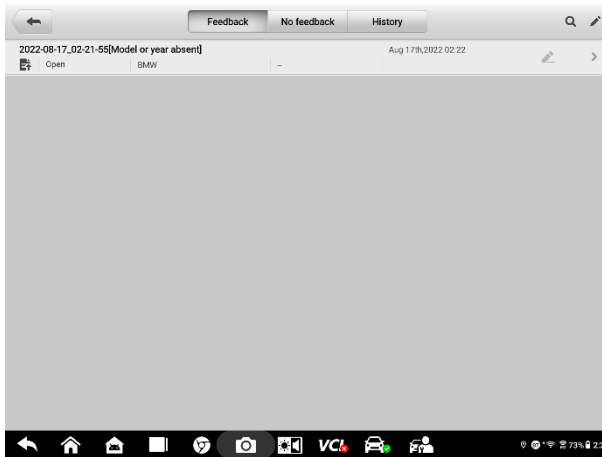

Figure 13-3 Data Logging Screen

- **To make a reply in a Data Logging session**
 1. Tap the **Feedback** tab to view the submitted data loggings.
 2. Select the latest message from Autel support service.
 3. Tap the input field at the bottom of the screen, and enter your reply. Additionally, tap the **Audio** button to record a voice message or tap the **Camera** button to take a screenshot.
 4. Tap **Send** to send your reply to Support.

13.5 Training

The Training section provides quick links to Autel's online video accounts. Select a video channel by language to see all available Autel online tutorial videos on such topics as product usage techniques and vehicle diagnostics practices.

13.6 FAQ

The FAQ section provides comprehensive references for all questions frequently asked and answered about the use of Autel's online member account, shopping, and payment procedures.

- Account — displays questions and answers about the use of Autel's online user account.
- Shopping & Payment — displays questions and answers about online product purchase and payment methods or procedures.

14. OEM Authorization

The OEM Authorization application allows to unlock the gateway ECU (CGW) for some vehicles to perform advanced diagnostics tests.

NOTE

Make sure the tablet is connected to the Internet before launching the OEM Authorization application.

➤ To unlock the gateway ECU (CGW)

1. Connect the MaxiSys tablet to the vehicle through the VCI. See [Establish Vehicle Communication](#) for details.
2. Tap **Diagnostics** on the MaxiSys Job Menu.
3. Tap **Renault**, select the vehicle type and tap **OK** to confirm the vehicle information.
4. On the Information screen, tap **Unlock**.

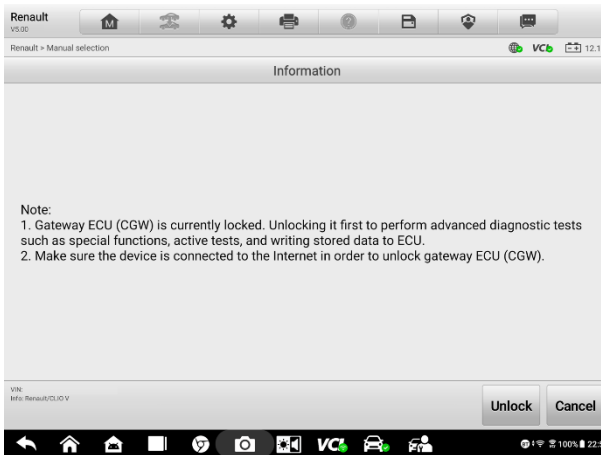

Figure 14-1 Information Screen

5. On the Purchase screen, tap **OK**. Select purchase method and pay to unlock the gateway. On the Purchase Successful screen, tap **OK**.

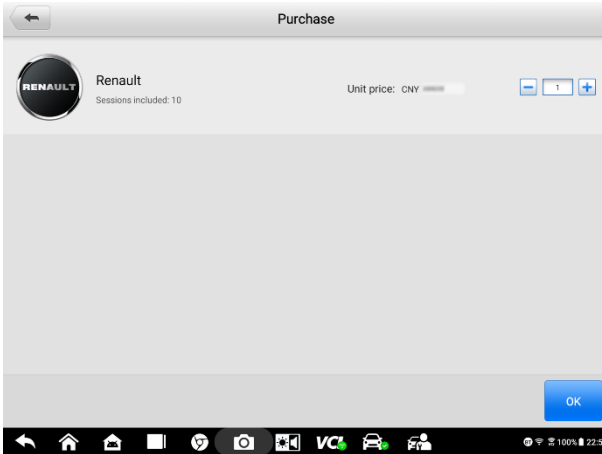

Figure 14-2 Purchase Screen

6. Exit the application. Tap **OEM Authorization** on the MaxiSys Job Menu. On the OEM Authorization screen, tap **Renew**. The Unlocking Information screen appears, on which you can view the remaining service sessions.

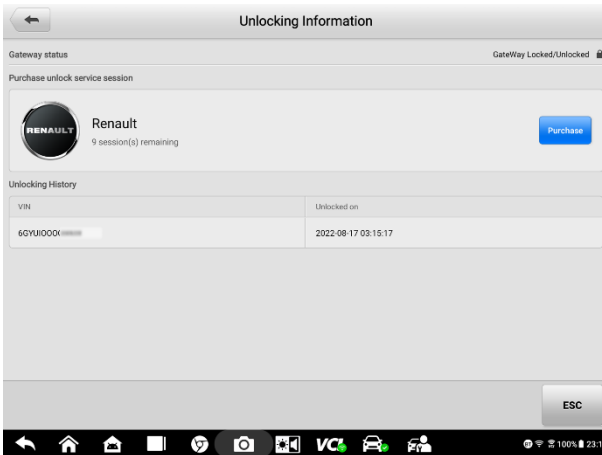

Figure 14-3 Unlocking Information Screen

15. MaxiViewer

MaxiViewer allows you to search for functions supported by our tools and the version information. There are two ways of searching, either by searching the tool and the vehicle or searching the functions.

➤ **To search by vehicle**

1. Tap the **MaxiViewer** application on the MaxiSys Job Menu. The MaxiViewer application screen displays.
2. Tap the tool name on the top-left to drop down the tool list, tap the one you want to search.
3. Choose the vehicle brand, model, and year you want to search.
4. All the functions supported by the selected tool for the selected vehicle display within three columns, function, sub function, and version.

➤ **To search by the functions**

1. Tap the **MaxiViewer** application on the MaxiSys Job Menu. The MaxiViewer application screen displays.
2. Tap the tool name on the top-left to drop down the tool list, then choose the one you want to search.
3. Enter the function you want to search in the top-right search box. The screen will display all vehicles that support this function, along with information such as the vehicles' year, system, capacity, type, function, sub-function, and version.

 **NOTE**

Fuzzy search is supported.

16. MaxiVideo

The MaxiVideo application configures the MaxiSys tablet to operate as a digital video scope by simply connecting the tablet to a MaxiVideo camera. This function allows you to examine difficult-to-reach areas normally hidden from sight, with the ability to record digital still images and videos, which offers you an economical solution to inspect machinery, facilities, and infrastructure in a safe and quick way.

Two sizes of imager head are available: 8.5 mm and 5.5 mm.

NOTE

The MaxiVideo camera and its fittings are optional. Please purchase them separately. For detailed product operation instructions, please refer to the Quick Reference Guide of the MaxiVideo camera.

17. Quick Link

The Quick Link application provides you with convenient access to Autel's official website and many other well-known sites in automotive service, which offers you abundant information and resources, such as technical help, knowledge bases, forums, training, and expert consultations.

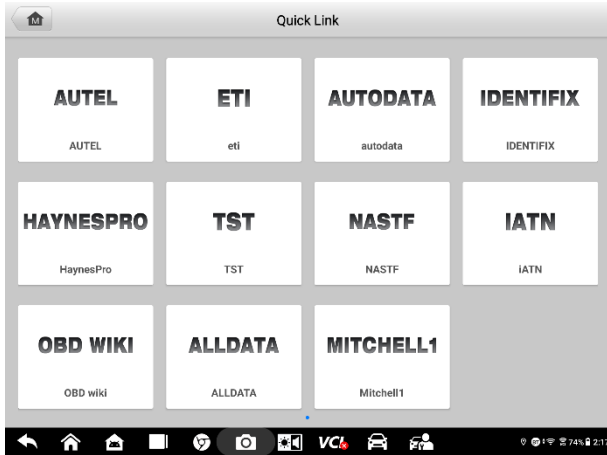

Figure 17-1 Quick Link Screen

➤ To open a quick link

1. Tap **Quick Link** on the MaxiSys Job Menu. The **Quick Link** application screen displays.
2. Select a website thumbnail from the main section. The Chrome browser is launched and the selected website is opened.
3. Now you can start exploring the website.

18. Remote Desktop

The Remote Desktop application launches the TeamViewer Quick Support program, which is a simple, fast and secure remote control interface. You can use the application to receive ad-hoc remote support from Autel's support center, colleagues or friends, by allowing them to control your MaxiSys tablet on their PC via the TeamViewer software.

18.1 Operations

If you think of a TeamViewer connection as a phone call, the TeamViewer ID would be the phone number, under which all TeamViewer Clients can be reached separately. Computers and mobile devices that run TeamViewer are identified by a globally unique ID. The first time the Remote Desktop application is started, this ID is generated automatically based on the hardware characteristics and will not change.

Make sure the tablet is connected to the Internet before launching the Remote Desktop application, so that the tablet is able to receive remote support from a third party.

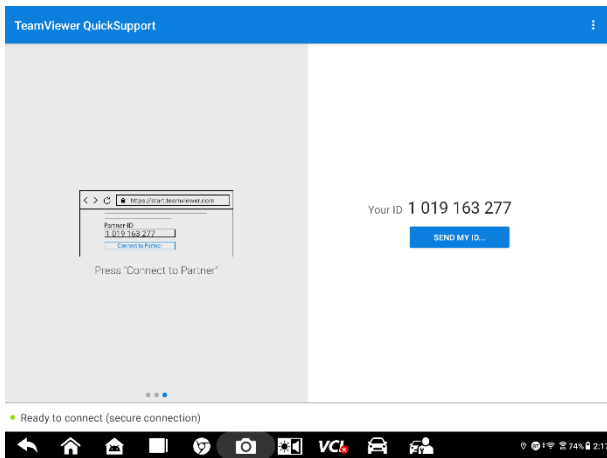

Figure 18-1 Remote Desktop Screen

- **To receive remote support from a partner**
 1. Power on the tablet.
 2. Tap the **Remote Desktop** application on the MaxiSys Job Menu. The TeamViewer interface displays and the device ID is generated and shown.
 3. Your partner must install the Remote Control software to his/her computer by downloading the TeamViewer full version program online

(<http://www.teamviewer.com>). Start the software on his/her computer at the same time, in order to provide support and take control of the tablet remotely.

4. Provide your ID to the partner, and wait for him/her to send you a remote control request.
5. A message displays to ask for your confirmation to allow remote control on your device.
6. Tap **Allow** to accept, or tap **Deny** to reject.
7. Refer to the associated TeamViewer documents for additional information.

19. User Feedback

The User Feedback feature allows you to submit questions related to this product.

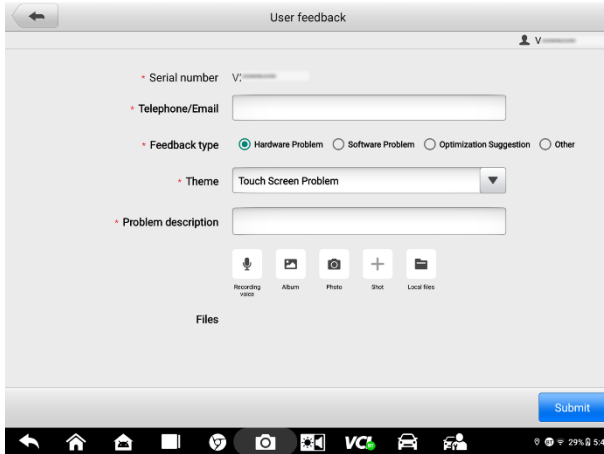

Figure 19-1 User Feedback Screen

➤ To send new user feedback

1. Register the product online. See [Product Registration](#) for detailed information.
2. Tap **User Feedback** on the MaxiSys Job Menu. The device information is automatically synchronized with the online account.
3. Enter your telephone number/email address, feedback type, theme, and problem description. You can also attach a voice recording, photo, photo album, screen captures, image or PDF files to the form. To help us resolve the issue more efficiently, we recommend you complete the form with as many details as possible.
4. Tap **Submit** to send the completed form to Autel's online service center. The submitted feedback will be carefully read and handled by our support personnel.

20. Maintenance and Service

To ensure that the tablet and the combined VCI unit perform at their optimum level, we advise that the product maintenance instructions in this section are strictly followed.

20.1 Maintenance Instructions

The following includes how to maintain your devices, together with precautions to take.

- Use a soft cloth dampened with alcohol or mild glass cleaner to clean the tablet touchscreen at the end of each work day.
- Do not use any abrasive cleansers, detergent, or automotive chemicals on the tablet.
- Keep the devices in dry conditions and within specified operating temperatures.
- Dry your hands before using the tablet. The touchscreen of the tablet may not work when it is moist, or when you tap the touchscreen with wet hands.
- Do not store the devices in humid, dusty or dirty areas.
- Check the housing, wiring, and connectors for dirt and damage before and after each use.
- Do not attempt to disassemble your tablet or the VCI unit.
- Do not drop or cause severe impact to the devices.
- Use only authorized battery chargers and accessories. Any malfunction or damage caused by the use of unauthorized battery charger or accessories will void the limited product warranty.
- Ensure that the battery charger does not contact conductive objects.
- Do not use the tablet beside microwave ovens, cordless phones and certain medical or scientific instruments to prevent signal interference.

20.2 Troubleshooting Checklist

- A. When the tablet does not work properly:
- Make sure the tablet has been registered online.
 - Make sure the system software and diagnostic application are properly updated.
 - Make sure the tablet is connected to the Internet.

- Check all cables, connections, and indicators to see if the signal is being received.
- B. When battery life is shorter than usual:
- This may happen when you are in an area with low signal strength. Turn off your device if it is not in use.
- C. When you cannot turn on the tablet:
- Make sure the tablet is connected to a power source or the battery is charged.
- D. When you are unable to charge the tablet:
- Your charger maybe out of order. Contact your nearest dealer.
 - You may be attempting to use the device in an overly hot/cold temperature. Charge the device in a temperate area.
 - Your device may not be connected to the charger properly. Check the connector.

 **NOTE**

If the problems persist, please contact Autel's technical support personnel or your local selling agent.

20.3 About Battery Usage

Your tablet is powered by a built-in lithium-ion polymer battery, which enables you to recharge your battery when there is electricity left.

 **DANGER**

The built-in lithium-ion polymer battery is factory-replaceable only; incorrect replacement or tampering with the battery pack may cause an explosion.

- Do not use a damaged battery charger.
- Do not disassemble, open, crush, bend, deform, puncture, or shred the battery.
- Do not modify, remanufacture or attempt to insert foreign objects into the battery, or expose the battery to fire, explosion, or other hazards.
- Only use the specified charger and USB cables. Use of non-Autel-authorized charger or USB cables may lead to device malfunction or failure.
- Use of an unqualified battery or charger may present a risk of fire, explosion, leakage, or other hazards.
- Avoid dropping the tablet. If the tablet is dropped, especially on a hard surface, and you suspect damage, take the tablet to a service center for inspection.
- Try to keep closer to your wireless router to reduce battery usage.
- The time needed to recharge the battery varies depending on the remaining battery

capacity.

- Battery life inevitably shortens over time.
- Unplug the charger once the tablet is fully charged since overcharging may shorten battery life.
- Keep the battery in temperate environments. Do not place it inside a car when it is too hot or too cold, which may reduce the capacity and life of the battery.

20.4 Service Procedures

This section provides information on technical support, repair service, and application for replacement or optional parts.

20.4.1 Technical Support

If you have any question or problem on product operations, please contact us.

AUTEL NORTH AMERICA

- **Phone:** 1-855-AUTEL-US (855-288-3587) Monday-Friday 9AM-6PM Eastern Time
- **Website:** www.autel.com
- **Email:** sales@autel.com; ussupport@autel.com
- **Address:** 36 Harbor Park Drive, Port Washington, New York, USA 11050

AUTEL EUROPE

- **Phone:** +49(0)89 540299608 Monday-Friday, 9:00AM-6:00PM Berlin Time
- **Website:** www.autel.eu
- **Email:** salesoffice.eu@autel.com; support.eu@autel.com
- **Address:** Landsberger Str. 408, 4. OG, 81241 München, Germany

AUTEL CHINA HEADQUARTERS

- **Phone:** +86-0755-8614-7779 Monday-Friday, 9:00AM-6:00PM Beijing Time
- **Website:** www.auteltech.cn
- **Email:** sales@auteltech.net; support@autel.com
- **Address:** 7-8th, 10th Floor, Building B1, Zhiyuan, Xueyuan Road, Xili, Nanshan, Shenzhen, 518055, China

AUTEL APAC

- **Phone:** +81-045-548-6282
- **Website:** www.autel.com/jp/
- **Email:** sales.jp@autel.com; support.jp@autel.com

- **Address:** 6th Floor, Ari- Nadoribiru 3-7-7, Shin-Yokohama, Kouhoku-Ku, Yokohama-Shi, Kanagawa-Ken, 222-0033 Japan

AUTEL IMEA

- **Phone:** +971 585 002709
- **Website:** www.autel.com
- **Email:** sales.imea@autel.com; imea-support@autel.com
- **Address:** 906-17, Preatoni Tower (Cluster L), Jumeirah Lakes Tower, DMCC, Dubai, UAE

AUTEL LATIN AMERICA

- **Phone:** +52 33 1001 7880 (Spanish in Mexico), +55 19 97816 4911 (Portuguese in Brazil)
- **Website:** www.autel.com
- **Email:** sales.latin@autel.com; latsupport@autel.com; brsupport@autel.com
- **Address:** Avenida Americas 1905, 6B, Colonia Aldrete, Guadalajara, Jalisco, Mexico

For technical assistance in other markets, please contact your local selling agent.

20.4.2 Repair Service

If it is necessary to send back your device for repair, please download and fill out the repair service form from www.autel.com. The following information must be included:

- Contact name
- Return address
- Telephone number
- Product name
- Complete description of the problem
- Proof-of-purchase for warranty repairs
- Preferred method of payment for non-warranty repairs

NOTE

For non-warranty repairs, payment can be made with Visa, Master Card, or with approved credit terms.

Send the device to your local agent, or to the address below:

7-8th, 10th Floor, Building B1, Zhiyuan,

Xueyuan Road, Xili, Nanshan,

Shenzhen, 518055, China

20.4.3 Other Services

You can purchase the accessories directly from authorized tool suppliers of Autel, or your local distributor or agent.

Your purchase order should include the following information:

- Contact information
- Product or part name
- Item description
- Purchase quantity

21. Compliance Information

FCC Compliance

FCC ID: WQ8-MS909DV2125

This equipment has been tested and verified to comply with the limits for a Class B digital device, pursuant to Part 15 of the FCC Rules. These limits are designed to provide reasonable protection against harmful interference in a residential installation. This equipment generates uses and can radiate radio frequency energy and, if not installed and used in accordance with the instructions, may cause harmful interference to radio communications. However, there is no guarantee that interference will not occur in a particular installation. If this equipment does cause harmful interference to radio or television reception, which can be determined by turning the equipment off and on, the user is encouraged to correct the interference by one or more of the following measures:

- Reorient or relocate the receiving antenna.
- Increase the separation between the equipment and receiver.
- Consult the dealer or an experienced radio/TV technician for help.

This device complies with part 15 of the FCC Rules. Operation is subject to the following two conditions:

- (1) This device may not cause harmful interference, and
- (2) This device must accept any interference received, including interference that may cause undesired operation.

Changes or modifications not expressly approved by the party responsible for compliance could void the user's authority to operate the equipment.

SAR:

The radiated output power of this device is below the FCC radio frequency exposure limits. Nevertheless, the device should be used in such a manner that the potential for human contact is minimized during normal operation.

The exposure standard for wireless devices employs a unit of measurement known as the Specific Absorption Rate, or SAR. The SAR limit set by the FCC is 1.6 W/Kg. Tests for SAR are conducted using standard operating positions accepted by the FCC with the device transmitting at its highest certified power level in all tested frequency bands. Although the SAR is determined at the highest certified power level, the actual SAR level of the device while operating can be well below the maximum value. This is because the device is designed to operate at multiple power levels to use only the power required to reach the network. To avoid the possibility of exceeding the FCC radio frequency exposure limits, human proximity to antenna should be minimized.

22. Warranty

22.1 12-Month Limited Warranty

Autel Intelligent Technology Corp., Ltd. (the Company) warrants to the original retail purchaser of this MaxiSys Diagnostics Device that should this product or any part thereof during normal usage and under normal conditions be proven defective in material or workmanship that results in product failure within twelve (12) months period from the date of purchase, such defect(s) will be repaired, or replaced (with new or rebuilt parts) with Proof of Purchase, at the Company's option, without charge for parts or labor directly related to the defect(s).

The Company shall not be liable for any incidental or consequential damages arising from the use, misuse, or mounting of the device. Some states do not allow limitation on how long an implied warranty lasts, so the above limitations may not apply to you.

This warranty does not apply to:

- a) Products subjected to abnormal use or conditions, accident, mishandling, neglect, unauthorized alteration, misuse, improper installation or repair or improper storage;
- b) Products whose mechanical serial number or electronic serial number has been removed, altered or defaced;
- c) Damage from exposure to excessive temperatures or extreme environmental conditions;
- d) Damage resulting from connection to, or use of any accessory or other product not approved or authorized by the Company;
- e) Defects in appearance, cosmetic, decorative or structural items such as framing and non-operative parts.
- f) Products damaged from external causes such as fire, dirt, sand, battery leakage, blown fuse, theft or improper usage of any electrical source.

! IMPORTANT

All contents of the product may be deleted during the process of repair. You should create a back-up copy of any contents of your product before delivering the product for warranty service.
