

Trademarks

Autel®, MaxiSys®, MaxiDAS®, MaxiScan®, MaxiTPMS®, MaxiRecorder®, and MaxiCheck® are trademarks of Autel Intelligent Technology Corp., Ltd., registered in China, the United States, and other countries. All other marks are trademarks or registered trademarks of their respective holders.

Copyright Information

No part of this manual may be reproduced, stored in a retrieval system or transmitted in any form or by any means electronic, mechanical, photocopying, recording, or otherwise without the prior written permission of Autel.

Disclaimer of Warranties and Limitation of Liabilities

All information, specifications and illustrations in this manual are based on the latest information available at the time of printing.

Autel reserves the right to make changes at any time without notice. While information of this manual has been carefully checked for accuracy, no guarantee is given for the completeness and correctness of the contents, including but not limited to the product specifications, functions, and illustrations.

Autel will not be liable for any direct, special, incidental, or indirect damages, or for any economic consequential damages (including lost profits) as a result of using this product.

IMPORTANT

Before operating or maintaining this unit, please read this manual carefully, paying extra attention to the safety warnings and precautions.

For Services and Support:



pro.autel.com
www.autel.com



1-855-288-3587/1-855-AUTELUS (North America)
0086-755-86147779 (China)



support@autel.com

For details, please refer to the *Service Procedures* in this manual.

Safety Information

For your own safety and the safety of others, and to prevent damage to the device and vehicles upon which it is used, it is important that the safety instructions presented throughout this manual be read and understood by all persons operating or coming into contact with the device.

There are numerous procedures, techniques, tools, and parts for servicing vehicles, as well as in the skill of the person doing the work. Because of the vast number of test applications and variations in the products that can be tested with this equipment, we cannot possibly anticipate or provide advice or safety messages to cover every circumstance. It is the automotive technician's responsibility to be knowledgeable of the system being tested. It is crucial to use proper service methods and test procedures. It is essential to perform tests in an appropriate and acceptable manner that does not endanger your safety, the safety of others in the work area, the device being used, or the vehicle being tested.

Before using the device, always refer to and follow the safety messages and applicable test procedures provided by the manufacturer of the vehicle or equipment being tested. Use the device only as described in this manual. Read, understand, and follow all safety messages and instructions in this manual.

Safety Messages

Safety messages are provided to help prevent personal injury and equipment damage. All safety messages are introduced by a signal word indicating the hazard level.

DANGER

Indicates an imminently hazardous situation which, if not avoided, will result in death or serious injury to the operator or to bystanders.

WARNING

Indicates a potentially hazardous situation which, if not avoided, could result in death or serious injury to the operator or to bystanders.

Safety Instructions

The safety messages herein cover situations Autel is aware of. Autel cannot know, evaluate or advise you in regards of all possible hazards. You must be certain that any condition or service procedure encountered does not jeopardize your personal safety.

 **DANGER**

When an engine is operating, keep the service area WELL VENTILATED or attach a building exhaust removal system to the engine exhaust system. Engines produce carbon monoxide, an odorless, poisonous gas that causes slower reaction time and can lead to serious personal injury or loss of life.

 **It is not advised to use headphones at a high volume**

Listening at high volumes for long periods of time may result in loss of hearing.

 **Safety Warnings**

- Always perform automotive testing in a safe environment.
- Wear safety eye protection that meets ANSI standards.
- Keep clothing, hair, hands, tools, test equipment, etc., away from all moving or hot engine parts.
- Operate the vehicle in a well-ventilated work area.
- Put the transmission in PARK (for automatic transmission) or NEUTRAL (for manual transmission) and make sure the parking brake is engaged.
- Put blocks in front of the drive wheels and never leave the vehicle unattended while testing.
- Be extra cautious when working around the ignition coil, distributor cap, ignition wires and spark plugs. These components create hazardous voltages when the engine is running.
- Keep a fire extinguisher suitable for gasoline, chemical, and electrical fires nearby.
- Do not connect or disconnect any test equipment while the ignition is on or the engine is running.
- Keep the test equipment dry, clean, and free from oil, water, and grease. Use a mild detergent on a clean cloth to clean the outside of the equipment as necessary.
- Do not drive the vehicle and operate the test equipment at the same time. Any distraction may cause an accident.
- Refer to the service manual for the vehicle being serviced and adhere to all diagnostic procedures and precautions. Failure to do so may result in personal injury or damage to the test equipment.
- To avoid damaging the test equipment or generating false data, make sure the vehicle battery is fully charged and the connection to the vehicle DLC is clean and secure.
- Do not place the test equipment on the distributor of the vehicle. Strong electro-magnetic interference can damage the equipment.

CONTENTS

SAFETY INFORMATION	ii
SAFETY INSTRUCTIONS	ii
1 USING THIS MANUAL	1
1.1 CONVENTIONS	1
2 GENERAL INTRODUCTION	3
2.1 MAXISYS TABLET.....	3
2.2 MAXIFLASH VCI	7
2.3 ACCESSORIES KIT.....	10
3 GETTING STARTED	12
3.1 POWER UP.....	12
3.2 POWER DOWN.....	15
4 DIAGNOSTICS	17
4.1 ESTABLISH VEHICLE COMMUNICATION AND SELECTION.....	17
4.2 DIAGNOSTICS SCREEN LAYOUT	27
4.3 AUTO SCAN.....	31
4.4 CONTROL UNIT	33
4.5 ECU INFORMATION	34
4.6 TROUBLE CODES	35
4.7 LIVE DATA.....	36
4.8 ACTIVE TEST	43
4.9 SPECIAL FUNCTIONS	44
4.10 PROGRAMMING AND CODING.....	45
4.11 GENERIC OBDII OPERATIONS.....	48
4.12 DIAGNOSTICS REPORT	52
4.13 EXIT DIAGNOSTICS.....	56
5 INTELLIGENT DIAGNOSTICS	58
5.1 ACCESSING INTELLIGENT DIAGNOSTICS.....	58
5.2 INTELLIGENT DIAGNOSTICS OPERATION.....	63
6 SERVICE	71
6.1 OIL RESET SERVICE.....	71
6.2 ELECTRIC PARKING BRAKE (EPB) SERVICE	72
6.3 TIRE PRESSURE MONITORING SYSTEM (TPMS) SERVICE.....	72
6.4 BATTERY MANAGEMENT SYSTEM (BMS) SERVICE	72
6.5 DIESEL PARTICLE FILTER (DPF) SERVICE	73

6.6 IMMOBILIZER (IMMO) SERVICE	74
6.7 STEERING ANGLE SENSOR (SAS) SERVICE.....	74
7 BATTERY TEST.....	76
7.1 TEST PREPARATION	76
7.2 IN-VEHICLE TEST	77
7.3 OUT-VEHICLE TEST	82
8 OEM AUTHORIZATION	84
9 SETTINGS	86
9.1 UNIT.....	86
9.2 LANGUAGE	87
9.3 PRINTING SETTINGS	87
9.4 REPORT SETTINGS.....	88
9.5 PUSH NOTIFICATIONS.....	88
9.6 AUTO UPDATE	89
9.7 VEHICLE LIST	89
9.8 SYSTEM SETTINGS.....	89
9.9 ABOUT.....	90
10 DATA MANAGER.....	91
10.1 VEHICLE HISTORY	92
10.2 WORKSHOP INFORMATION	94
10.3 CUSTOMER	94
10.4 IMAGE.....	95
10.5 CLOUD REPORT.....	97
10.6 PDF FILES.....	97
10.7 REVIEW DATA.....	97
10.8 DATA LOGGING.....	98
10.9 UNINSTALL APPS	98
11 VCI MANAGER	99
11.1 VCI CONNECTION VIA BLUETOOTH	99
11.2 BAS CONNECTION VIA BLUETOOTH	100
11.3 VCI UPDATE	100
11.4 BAS UPDATE	101
12 UPDATE	103
13 SUPPORT	105
13.1 PRODUCT REGISTRATION	105

13.2 SUPPORT SCREEN LAYOUT	105
13.3 MY ACCOUNT	106
13.4 TRAINING	106
13.5 DATA LOGGING	106
13.6 FAQ DATABASE	107
14 MAXVIEWER	108
15 MAXISCOPE	109
16 MAXIVIDEO	110
17 QUICK LINK	111
18 REMOTE DESKTOP	112
18.1 OPERATIONS	112
19 USER FEEDBACK	114
20 AUTEL USER CENTER	115
21 MAINTENANCE AND SERVICE	117
21.1 MAINTENANCE INSTRUCTIONS	117
21.2 TROUBLESHOOTING CHECKLIST	117
21.3 ABOUT BATTERY USAGE	118
21.4 SERVICE PROCEDURES	119
22 COMPLIANCE INFORMATION	122
23 WARRANTY	124
23.1 12-MONTH LIMITED WARRANTY	124

1 Using This Manual

This manual contains device usage instructions.

Some illustrations shown in this manual may contain modules and optional equipment that are not included in your system.

1.1 Conventions

The following conventions are used:

1.1.1 Bold Text

Bold text is used to highlight selectable items such as buttons and menu options.

Example:

- Tap **OK**.

1.1.2 Notes and Important Messages

Note

A **NOTE** provides helpful information such as additional explanations, tips, and comments.

Example:

 **NOTE**

New batteries reach full capacity after approximately 3 to 5 charging and discharging cycles.

Important

IMPORTANT indicates a situation that if not avoided may result in damage to the tablet or vehicle.

Example:

 **IMPORTANT**

Keep the cable away from heat, oil, sharp edges and moving parts. Replace damaged cables immediately.

1.1.3 Hyperlinks

Hyperlinks or links that take you to other related articles, procedures, and illustrations are available in electronic documents. Blue italic text indicates a selectable hyperlink and blue underlined text indicates a website link or an email address link.

1.1.4 Illustrations

The illustrations used in this manual are samples and the actual interface may vary for each vehicle being tested. Observe the menu titles and on-screen instructions to make the correct option selection.

1.1.5 Procedures

An arrow icon indicates a procedure.

Example:

➤ **To use the camera**

1. Tap the **Camera** button to open the camera application.
2. Focus the image to be captured in the viewfinder.
3. Tap the camera icon on the right side of the screen. The viewfinder now shows the captured picture and auto-saves the taken photo.
4. Swipe the screen left to view the stored photos.
5. Tap the **Back** or **Home** button to exit the camera application.

2 General Introduction

The MaxiSys® Elite II Pro Diagnostic Platform is the next generation of smart solution for specialized automotive diagnosis. Featuring the Qualcomm octa-core processor, a 9.7" LED display with a super sensitive capacitive touchscreen, combined with an optimized array of powerful applications, and the best possible coverage of OE-level diagnostics, the MaxiSys Elite II Pro performs every job from comprehensive vehicle diagnostics and analysis to advanced ECU programming quickly and efficiently.

There are 2 main components to the MaxiSys Elite II Pro system:

- MaxiSys Tablet — the central processor and monitor
- Vehicle Communication Interface (VCI) — the device for accessing vehicle data

This manual describes the construction and operation of these devices and how they work together to deliver diagnostic solutions.

2.1 MaxiSys Tablet

2.1.1 Functional Description

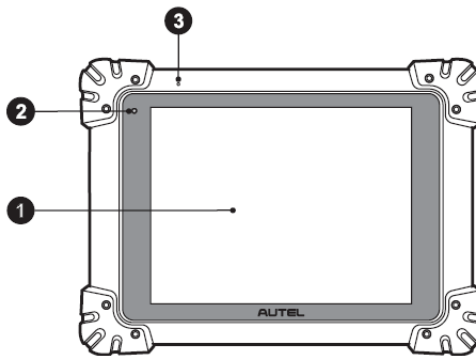

Figure 2-1 MaxiSys Tablet, Front View

1. 9.7" LED Capacitive Touchscreen
2. Ambient Light Sensor — detects ambient light brightness
3. Microphone

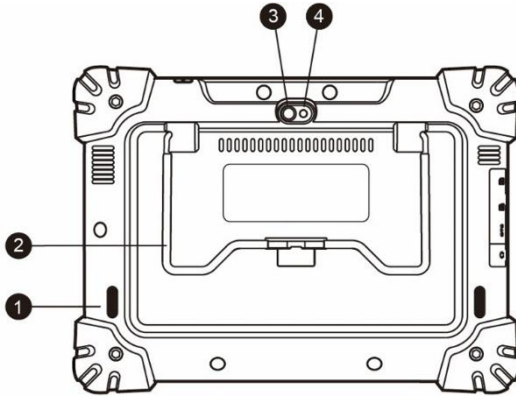

Figure 2-2 MaxiSys Tablet, Back View

1. Speaker
2. Collapsible Stand — extends from the back to allow hands-free viewing of the tablet
3. Rear Camera
4. Camera Flash

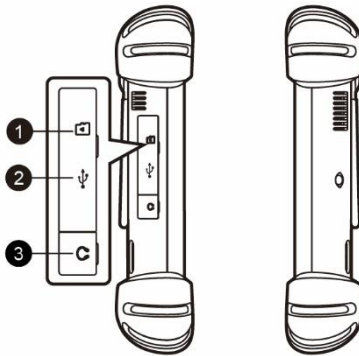

Figure 2-3 MaxiSys Tablet, Side Views

1. Mini SD (Secure Digital) Card Slot
2. Mini USB (Universal Serial Bus) Port
3. Headphone Jack

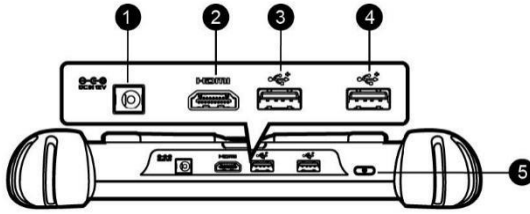

Figure 2-4 MaxiSys Tablet, Top View

1. DC Power Supply Input Port
2. HDMI (High-definition Multimedia Interface) Port
3. USB Port
4. USB Port
5. Power/Lock Button — long press to turn the tablet on and off, or short press to lock the screen

2.1.2 Power Sources

The tablet can receive power from any of the following sources:

- Internal battery pack
- AC/DC power supply
- Vehicle power

! IMPORTANT

Do not charge the battery when the temperature is below 0°C (32°F) or above 45°C (113°F).

Internal Battery Pack

The tablet can be powered with its internal rechargeable battery, which if fully charged can provide sufficient power for about 7.5 hours of continuous operation.

AC/DC Power Supply

The tablet can be powered from an electrical outlet using the AC/DC power adapter. The AC/DC power supply also charges the internal battery pack.

Vehicle Power

The tablet can be powered from the auxiliary power outlet adapter or other DC power port on the test vehicle through a direct cable connection. The vehicle power cable connects to the DC power supply port on the top side of the tablet.

2.1.3 Technical Specifications

Table 2-1 Tablet Specifications

Item	Description
Operating System	Android 10.0
Processor	Qualcomm octa-core processor (2.2 GHz quad-core A73 + 1.8 GHz quad-core A53)
Memory	4 GB RAM & 128 GB on-board memory
Display	9.7" HD display with 2048 × 1536 resolution & capacitive touchscreen
Connectivity	<ul style="list-style-type: none">● Wi-Fi 802.11 a/b/g/n/ac● Bluetooth V5.0 + EDR● USB 2.0● HDMI● SD Card (Support up to 64 GB)
Camera	<ul style="list-style-type: none">● Rear: 16.0 megapixel● Autofocus with flashlight
Sensors	<ul style="list-style-type: none">● Gravity accelerometer● Ambient Light Sensor (ALS)
Audio Input / Output	<ul style="list-style-type: none">● Microphone● Dual speakers● 3-band 3.5 mm stereo/standard headset jack
Power and Battery	<ul style="list-style-type: none">● 3.7 V/11000 mAh Lithium-polymer battery● Charging via 12 V AC/DC power supply with a temperature between 0 °C and 45 °C
Input Voltage	12 V (9 to 24 V)

Item	Description
Power Consumption	6.5 W
Operating Temp.	0 to 50 °C (32 to 122 °F)
Storage Temp.	-10 to 60 °C (14 to 140 °F)
Dimensions (w x h x d)	300 mm (11.81") x 220 mm (8.66") x 50 mm (1.97")
Weight	1.42 kg (3.13 lbs.)
Protocols	ISO 9142-2, ISO 14230-2, ISO 15765-4, K/L-Line, Flashing Code, SAE-J1850 VPW, SAE-J1850 PWM, CAN ISO 11898, Highspeed, Middlespeed, Lowspeed and Singlewire CAN, GM UART, UART Echo Byte Protocol, Honda Diag-H Protocol, TP 2.0, TP 1.6, SAE J1939, SAE J1708, Fault-Tolerant CAN

2.2 MaxiFlash VCI

2.2.1 Functional Description

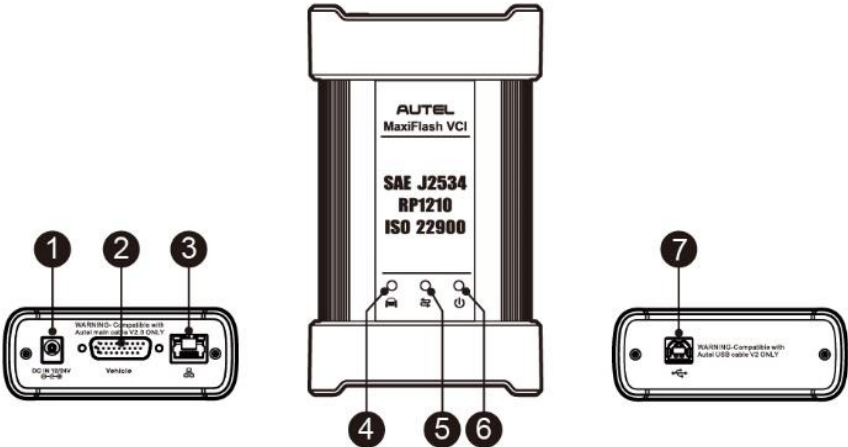

Figure 2-5 MaxiFlash VCI Views

1. DC Power Supply Input Port
2. Vehicle Data Connector
3. Ethernet Port
4. Vehicle LED
 - Flashes green when communicating with the vehicle's system
5. Connection LED
 - Lights solid green when connected with the tablet via USB cable
 - Lights solid blue when connected with the tablet via Bluetooth (BT)
6. Power LED
 - Lights solid yellow automatically at power-up when VCI is self-testing
 - Lights solid green when powered on
 - Lights solid red when system failure has occurred
 - Flashes red when VCI is upgrading
7. USB Port

Programming Capability

The MaxiFlash VCI is a D-PDU, SAE J2534 & RP1210 compliant PassThru programming interface device. Using the updated OEM software, it is capable of replacing the existing software/firmware in the Electronic Control Units (ECU), programming new ECUs, and fixing software-controlled drivability issues and emission issues.

! IMPORTANT

DO NOT disconnect the MaxiFlash VCI while the vehicle LED is on. If the reprogramming procedure is interrupted while the vehicle's ECU is blank or only partially programmed, the module may be unrecoverable.

Communication Capability

The MaxiFlash VCI supports Bluetooth and USB communication methods. It can transmit vehicle data to the tablet with or without a cable connection. In open areas, the working range of the transmitter through Bluetooth communication is up to 328 feet (about 100 m). If the signal is lost due to being taken out of range, communication will be restored once the tablet is within range.

2.2.2 Power Sources

The MaxiFlash VCI can receive power from the following sources:

- Vehicle power
- AC/DC power supply

Vehicle Power

The MaxiFlash VCI operates on 12/24 volt vehicle power, which receives power via the vehicle data connection port. The device powers on whenever it is connected to an OBDII/EOBD compliant Data Link Connector (DLC). For non-OBDII/EOBD compliant vehicles, the device can be powered from an auxiliary power outlet adapter or other suitable power port on the test vehicle using the auxiliary power cable.

AC/DC Power Supply

The MaxiFlash VCI can be powered from a wall socket using the AC/DC power adapter.

2.2.3 Technical Specifications

Table 2-2 MaxiFlash VCI Specifications

Item	Description
Communications	<ul style="list-style-type: none">● Bluetooth V5.0 + BR/EDR● USB 2.0● Ethernet
Input Voltage Range	DC 9 to 28 V
Supply Current	<ul style="list-style-type: none">● 190 mA @12 V● 110 mA @ 24 V
Operating Temp.	0 to 50 °C (32 to 122 °F)
Storage Temp.	-20 to 60 °C (-4 to 140 °F)
Dimensions (L x W x H)	149 mm (5.87") x 86 mm (3.38") x 35 mm (1.28")
Weight	0.29 kg (0.64 lb.)

2.3 Accessories Kit

2.3.1 Main Cable V2.0

The MaxiFlash VCI can be powered through the Autel Main Cable V2.0 (the V2.0 icon can be seen on the cable) when connected to an OBDII/EOBD compliant vehicle. The Main Cable V2.0 connects the VCI to the vehicle's DLC, through which the VCI can transmit vehicle data to the tablet.

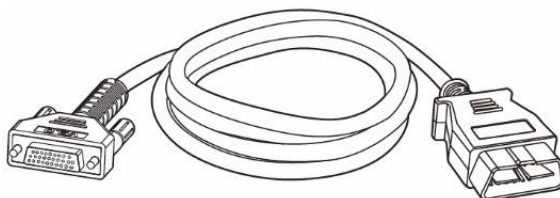

Figure 2-6 Main Cable V2.0 – 1.5m in Length

NOTE

The MaxiFlash VCI can be connected by the Autel Main Cable V2.0 only. DO NOT use other Autel main cables to connect the MaxiFlash VCI.

2.3.2 OBDI Adapters (Optional)

The optional OBDI-type adapters are for non-OBDII vehicles. The adapter used depends on the type of vehicle being tested. The adapters are sold separately. Please contact your distributor for detail.



Benz-14



Chrysler-16



BMW-20



Nissan-14

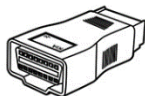

Kia-20



Fiat-3



PSA-2



Mazda-17

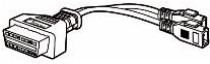

Volkswagen/Audi-
2+2



Benz-38



Mitsubishi/Hyundai
-12+16

2.3.3 Other Accessories

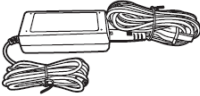

AC/DC Power Adapter (12 V)

Connects the tablet to the external DC power port for power supply.



USB 2.0 Cable V2 (the V2 icon can be seen on the cable)

Connects the tablet to the VCI.



Mini USB Cable

Connects the tablet to the computer.



Clipper Cable

Provides power to the tablet or the VCI through connection to the vehicle battery.



Auxiliary Power Outlet Adapter

Provides power to the tablet or the VCI through connection to the vehicle's auxiliary power outlet, as some non-OBDII vehicles cannot provide power via the DLC connection.

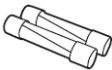

Spare Fuse x2

A safety device for the auxiliary power outlet adapter.

3 Getting Started

Make sure the tablet has sufficient power or is connected to the external power supply (see [Power Sources](#)).

NOTE

The images and illustrations depicted in this manual may differ from the actual ones.

3.1 Power Up

Long press the **Power/Lock** button on the top-right side of the tablet to switch the unit on. The system boots up and shows the lock screen. Slide up to unlock and enter the MaxiSys Job Menu screen.



Figure 3-1 MaxiSys Job Menu Screen

1. Application Buttons
2. Locator and Navigation Buttons
3. Status Icons

NOTE













It is recommended that you lock the screen when not in use to protect information in the system and conserve the power.





Almost all operations on the tablet are controlled through the touchscreen. The touchscreen navigation is menu-driven, which allows you to quickly locate the test procedure or data that you need, through a series of questions and options. Detailed descriptions of the menu structures can be found in the chapters for each application.

3.1.1 Application Buttons

The table below briefly describes each of the applications in the MaxiSys system.

Table 3-1 Applications







Name	Button	Description
Diagnostics		Accesses the unit's diagnostics functions. See Diagnostics .
Service		Accesses special functions menu. See Service .
Battery Test		Accesses the Battery Test menu with in-vehicle test and out-vehicle test functions. See Battery Test .
OEM Authorization		Accesses OEM authorization menu. See OEM Authorization .
Settings		Accesses the system settings menu. See Settings .
Data Manager		Accesses the saved repair shop, customer and vehicle data including detailed vehicle diagnostics and test records. See Data Manager .
VCI Manager		Accesses the VCI connection menu. See VCI Manager .
Update		Accesses system software update menu. See Update .
Support		Synchronizes Autel's online service database with the MaxiSys tablet. See Support .
MaxiViewer		Provides a quick search for supported functions and/or vehicles. See MaxiViewer .
MaxiScope		Configures the MaxiSys diagnostic device to operate as an automotive oscilloscope when work in combination with the MaxiScope module. See MaxiScope .
MaxiVideo		Configures the unit to operate as a video scope device by connecting to an imager head cable for close vehicle inspections. See MaxiVideo .





Name	Button	Description
Quick Link		Provides associated website bookmarks to allow quick access to product update, service, support, and other information. See Quick Link .
Remote Desktop		Configures your unit to receive remote support using the TeamViewer application. See Remote Desktop .
User Feedback		Allows you to submit questions related to this product. See User Feedback .
Autel User Center		Allows you to register an Autel account, view and edit your personal profile, and link your device. See Autel User Center .

3.1.2 Locator and Navigation Buttons

Operations of the Navigation buttons at the bottom of the screen are described in the table below:

Table 3-2 Locator and Navigation Buttons

Name	Button	Description
Locator		Indicates the location of the screen. Swipe the screen left or right to view the previous or next screen.
Back		Returns to the previous screen.
MaxiSys Home		Returns to the MaxiSys Job Menu.
Android Home		Returns to the Android system home screen.
Recent Apps		Displays a list of applications that are currently running. Tap an app icon to launch. Remove an app by swiping it to the left or right.
Browser		Launches the Chrome Internet browser.
Camera		Launches the camera. Press and hold to capture a screenshot of the current screen. Saved files are stored in the Data Manager application for later review. See Data Manager .

Name	Button	Description
Display & Sound		Adjusts the brightness of the screen and the volume of the audio output.
VCI		Opens the VCI Manager application. A green badge with a BT or USB icon at the bottom-right corner indicates the VCI is connected, while a red “x” icon will be displayed if the connection fails.
MaxiSys Shortcut		Returns to the Diagnostics screen.
Service Shortcut		Returns to the Service screen.

➤ **To use the camera**

1. Tap the **Camera** button. The camera screen opens.
2. Focus the image to be captured in the viewfinder.
3. Tap the camera icon on the right side of the screen. The viewfinder now shows the captured picture and auto-saves the taken photo.
4. Swipe the screen left to view the stored photos.
5. Tap the **Back** or **Home** button to exit the camera application.

🚫 **NOTE**

After swiping the camera screen from left to right, the camera mode and video mode can be switched by tapping the blue camera icon or video icon.

3.1.3 System Status Icons

Your MaxiSys tablet is a fully functional Android tablet with the standard Android operation system status icons. Refer to Android documentation for additional information.

3.2 Power Down

All vehicle communications should be terminated before shutting down the tablet. A warning message displays if a shutdown is attempted while the tablet is communicating with the vehicle. Forcing a shutdown while the tablet is communicating with the vehicle may lead to ECU problems on some vehicles. Please exit the Diagnostics application before shutting off the tablet.

➤ **To power down the MaxiSys tablet**

1. Press and hold the **Power/Lock** button.
2. Tap **Power Off**.
3. Tap **OK**.

3.2.1 Reboot System

In case of a system crash, press and hold the **Power/Lock** button and tap **Restart** to reboot the system.

4 Diagnostics

The Diagnostics application can access the electronic control module of multiple vehicle control systems, including but not limited to the engine, transmission, anti-lock brake system (ABS), and airbag system (SRS).

4.1 Establish Vehicle Communication and Selection

4.1.1 Establish Vehicle Communication

The Diagnostics operations require connecting the MaxiSys Elite II Pro tablet to the test vehicle through the MaxiFlash VCI using the Main Cable V2.0 (Use the applicable OBDI adapter if needed). To establish proper vehicle communication with the tablet, you need to perform the following steps:

1. Connect the VCI to the vehicle's DLC for both communication and power source.
2. Connect the VCI to the tablet via Bluetooth or USB connection.
3. Check the VCI navigation button at the bottom bar on the screen. If a green BT or USB icon appears at the lower-right corner, the MaxiSys Diagnostics Platform is ready to start vehicle diagnosis.

4.1.1.1 Vehicle Connection

The method used to connect the VCI to a vehicle's DLC depends on the vehicle's configuration as follows:

- A vehicle equipped with an On-board Diagnostics Two (OBDII) management system supplies both communication and 12-volt power through a standardized J-1962 DLC.
- A vehicle not equipped with an OBDII management system supplies communication through a DLC connection, and in some cases supplies 12-volt power through the auxiliary power outlet or a connection to the vehicle battery.

OBDII Vehicle Connection

This type of connection only requires the Main Cable V2.0 without any additional adapter.

➤ **To connect to an OBDII vehicle**

1. Connect the main cable's female adapter to the Vehicle Data Connector on the VCI and tighten the captive screws.
2. Connect the cable's 16-pin male adapter to the vehicle's DLC, which is generally located under the vehicle dashboard.

NOTE

The vehicle's DLC is not always located under the dashboard. Refer to the user manual of the test vehicle for additional connection information.

Non-OBDII Vehicle Connection

This type of connection requires both the Main Cable V2.0 and an OBDI adapter for the specific vehicle being serviced.

There are three possible scenarios for non-OBDII vehicle connection:

- DLC connection supplies both communication and power.
- DLC connection supplies communication and power is supplied via the auxiliary power outlet.
- DLC connection supplies communication and power is supplied via the vehicle battery.

➤ **To connect to a non-OBDII Vehicle**

1. Connect the main cable's female adapter to the Vehicle Data Connector on the VCI and tighten the captive screws.
2. Locate the required OBDI adapter and connect its 16-pin jack to the main cable's male adapter.
3. Connect the attached OBDI adapter to the vehicle's DLC.

NOTE

Some vehicles may have more than one adapter or may have test leads instead of an adapter. Make the proper connection to the vehicle DLC as required.

➤ **To connect the auxiliary power outlet adapter**

1. Plug the DC power connector of the auxiliary power outlet adapter into the DC power supply input port on the device.
2. Connect the male connector of the auxiliary power outlet adapter into the vehicle's auxiliary power outlet.

➤ **To connect the clipper cable**

1. Connect the tubular plug of the clipper cable to the male connector of the auxiliary power outlet adapter.

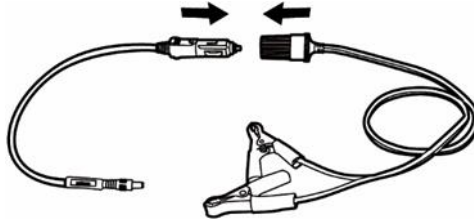

Figure 4-1 Connection between Auxiliary Power Outlet Adapter and Clipper Cable

2. Plug the DC power connector of the auxiliary power outlet adapter into the DC power supply input port of the VCI.
3. Connect the clipper cable to the vehicle's battery.

NOTE

After the VCI is successfully connected to the vehicle, the Power LED on the device lights solid green and a beeping sound will be heard.

4.1.1.2 VCI Connection

After the VCI is properly connected to the vehicle, the Power LED on the VCI lights solid green, and is ready to establish communication with the tablet.

The VCI supports two communication methods with the tablet: Bluetooth and USB.

Pairing via Bluetooth

In open areas, the working range for Bluetooth communication is about 328 feet (100 m), giving technicians greater mobility to perform vehicle diagnosis from anywhere in the repair shop.

To expedite multi-vehicle diagnostics, more than one VCI can be used in busy repair shops, enabling technicians to quickly pair their MaxiSys tablet to each VCI separately via Bluetooth and therefore eliminating the need to unplug the VCI from one vehicle and then connect it to another each time.

➤ To pair the tablet with the VCI via Bluetooth

1. Power up the tablet.
2. Select the **VCI Manager** application from the MaxiSys Job Menu.
3. Select **VCI BT** from the connection mode list. Tap the **Bluetooth** toggle to turn it ON. The device automatically scans for available VCIs for pairing. The found devices are listed on the right side of the screen.

NOTE

If no VCI is found, this may indicate that the signal strength is too weak to be detected. Reposition the VCI and remove all possible objects that may cause signal interference. Tap the **Scan** button at the top-right corner to rescan for the VCI.

4. Typically, the VCI name appears as “Maxi” suffixed with a serial number. Select the VCI for pairing. (If more than one VCI is used in the shop, ensure the correct VCI is selected for pairing.)
5. When pairing is successful, the connection status reads, “Connected.”
6. The VCI icon on the tablet navigation bar on the bottom appears as a green circle badge with a BT icon when the tablet and the VCI are connected.

USB Cable Connection

The USB cable connection is a simple and quick way to establish communication between the tablet and the VCI. After properly connecting the tablet to the VCI using the USB cable, the VCI navigation button at the bottom bar of the screen displays a green circle badge with a USB icon and the connection LED on the VCI lights solid green, indicating the connection between the devices is successful.

NOTE

The USB connection provides the most stable communication and is therefore the recommended communication method between the tablet and VCI when operating ECU programming or coding.

The MaxiSys diagnostic platform is now ready to perform vehicle diagnosis.

4.1.1.3 No Communication Message

- A. If the tablet is unable to connect to the VCI, an error message appears. An error message indicates the tablet is not communicating with the VCI. Troubleshoot the error by performing the following steps:
- Ensure the VCI is powered on.
 - When using the wireless connection, ensure the network is configured correctly and the proper device has been connected.
 - If the tablet loses communication abruptly during the diagnosis, ensure no objects are causing signal interference.
 - Ensure the VCI is properly positioned with the VCI front side up.
 - Move the tablet closer to the VCI. If using the wired connection, ensure the cable is securely attached to the VCI.
 - Ensure the connection LED is lit for the selected communication type: Bluetooth or USB.

B. If the VCI is unable to establish a communication link, a message will display. Possible causes for the communication error include:

- A vehicle system has been selected for diagnosis that is not supported by the vehicle.
- There is a loose connection.
- There is a blown vehicle fuse.
- The vehicle or the data cable has a wiring fault.
- There is a circuit fault in the data cable or adapter.
- The vehicle information entered is incorrect.

4.1.2 Getting Started

Prior to first use of the Diagnostics application, ensure the VCI is properly connected to and is communicating with the tablet. See [VCI Connection](#).

4.1.2.1 Vehicle Menu Layout

When the VCI is properly connected to the vehicle and the tablet, the platform is ready to start vehicle diagnosis. Tap the **Diagnostics** application button on the MaxiSys Job Menu, the Vehicle Menu will appear on the screen.

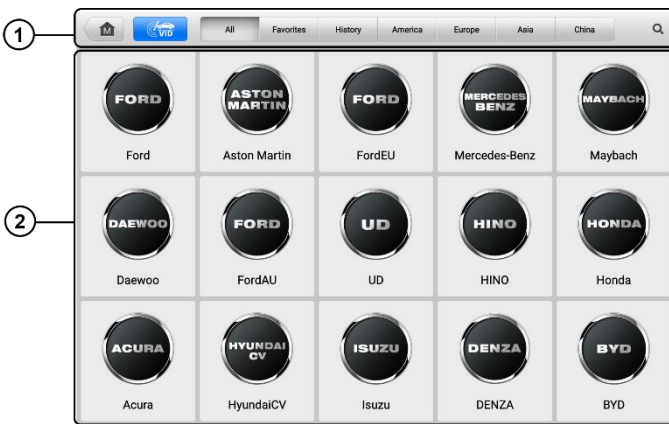



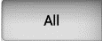
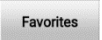
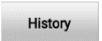

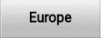
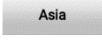
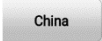

Figure 4-2 Vehicle Menu Screen

1. Top Toolbar Buttons
2. Automobile Manufacturer Icons

Top Toolbar Buttons

The operations of the Toolbar buttons at the top of the screen are listed and described in the table below:

Table 4-1 Top Toolbar Buttons

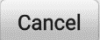
Name	Button	Description
Home		Returns to the MaxiSys Job Menu.
VID		<p>Opens a dropdown list.</p> <ul style="list-style-type: none"> ● Tap Auto Detect for auto VIN detection. ● Tap Manual Input to enter VIN or license number manually. ● Tap Scan VIN/License to scan the VIN/license number by camera.
All		Displays all the vehicle makes in the vehicle menu.
Favorites		Displays user-favorited vehicle makes.
History		Displays stored test vehicle records. This option provides you with direct access to previously tested vehicle records. See Vehicle History .
America		Displays the American vehicle menu.
Europe		Displays the European vehicle menu.
Asia		Displays the Asian vehicle menu.
China		Displays the Chinese vehicle menu.
Search		Tap to open a virtual keyboard and manually enter a specific vehicle make.
Cancel		Tap to exit the search screen or cancel an operation.

Automobile Manufacturer Icons

The automobile manufacturer icons display the various vehicle brand names. Select the proper manufacturer icon after the VCI is properly connected to the test vehicle to start a diagnostics session.

4.1.3 Vehicle Identification

The MaxiSys diagnostics system supports five methods of vehicle identification.

1. Auto Detect
2. Manual Input
3. Scan VIN/License
4. Manual Vehicle Selection
5. Alternative Vehicle Identification

4.1.3.1 *Auto Detect*

The MaxiSys diagnostics system features the latest VIN-based AutoVIN Scan function to identify the test vehicle with just one tap, enabling the technician to quickly identify the exact vehicle and scan its available systems for fault codes.

➤ **To perform an AutoVIN Scan**

1. Tap the **Diagnostics** application button on the MaxiSys Job Menu. The Vehicle Menu appears.
2. Tap the **VID** button on the top toolbar.
3. Select **Auto Detect**. The tablet starts VIN scanning on the vehicle's ECU. Once the test vehicle is successfully identified, the system will directly guide you to the Vehicle Diagnostics screen.



Figure 4-3 Auto Detect Screen

In some cases, the Auto VIN function is still available for some vehicle makes after being selected.

Select an automobile manufacturer icon from the Vehicle Menu screen (Figure 4-2) and then tap **Automatic Selection** > **Read**. The system will proceed to acquire VIN information automatically or allow users to manually enter the VIN.

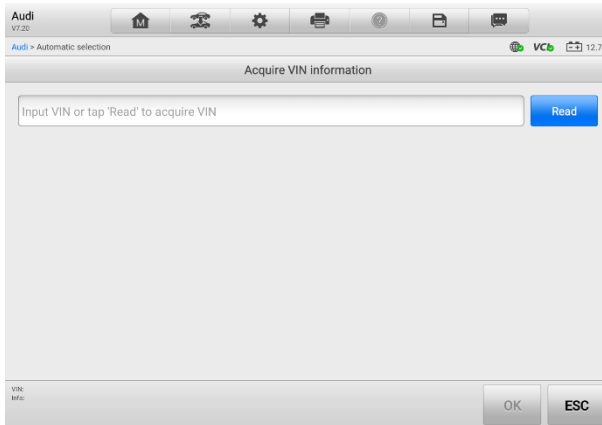

Figure 4-4 Automatic Selection Screen

4.1.3.2 Manual Input

For some vehicles that do not support the Auto VIN Scan function, the MaxiSys Diagnostics system allows you to manually enter the vehicle VIN or license number, or simply take a photo of the VIN sticker or license plate for quick vehicle identification.

➤ **To perform Manual Input**

1. Tap the **Diagnostics** application button on the MaxiSys Job Menu. The Vehicle Menu appears.
2. Tap the **VID** button on the top toolbar.
3. Select **Manual Input** in the dropdown list.
4. Tap the input box and enter the correct VIN or license number.



Figure 4-5 Manual VIN Input Screen

5. Tap **OK**. The vehicle will be identified and matched to the vehicle database and the Vehicle Diagnostics screen will appear.
6. Tap “**x**” on the top-right corner to exit Manual Input.

4.1.3.3 Scan VIN/License

➤ **To perform the Scan VIN/License**

1. Tap the **Diagnostics** application button on the MaxiSys Job Menu. The Vehicle Menu appears.
2. Tap the **VID** button on the top toolbar.
3. Tap **Scan VIN/License** in the dropdown list (Figure 4-3). The camera will launch. On the right side of the screen, from top to bottom, three options are available: Scan Bar Code, Scan VIN, and Scan License.

NOTE

The Scan License option is supported in certain countries and areas. If not available, manually enter the license number.

4. Select one of the three options and position the tablet to align the VIN or license number within the scanning window, the result appears in the Recognition Result dialog box after scanned. Tap **OK** to confirm the result, and then the vehicle information confirmation screen will appear on the tablet. If all the

vehicle information is correct, tap the icon in the middle of the screen to confirm the VIN of the vehicle being tested. Tap **OK** to continue.

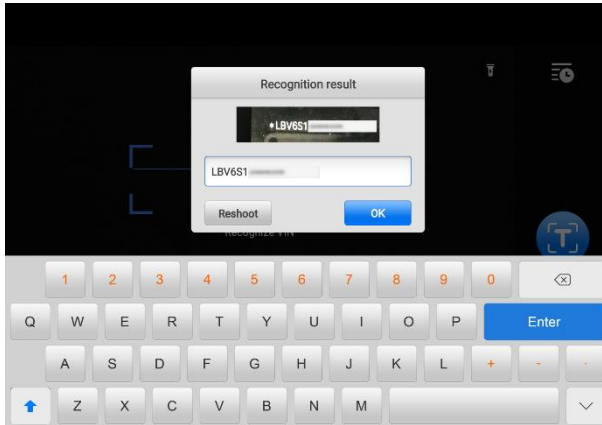



Figure 4-6 Scan VIN Screen 1

If the VIN/license number cannot be scanned, please manually enter it after tapping the pen-shape  icon. Tap **OK** to continue. Manually enter the license number and select a vehicle brand in the Vehicle Information Confirmation screen. Tap the icon in the middle of the screen to confirm the VIN of the vehicle being tested. Tap **OK** to continue.

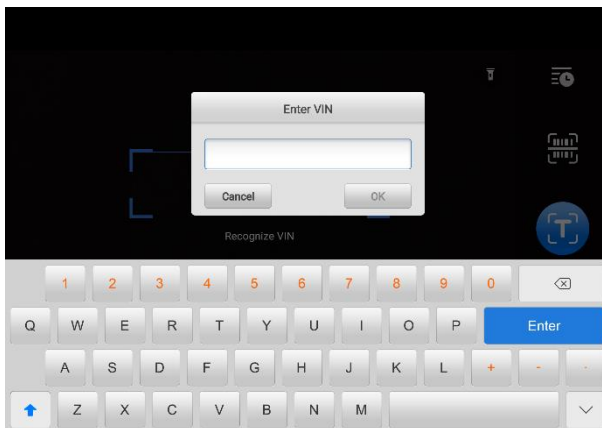

Figure 4-7 Scan VIN Screen 2

4.1.3.4 Manual Vehicle Selection

When the vehicle's VIN is not automatically retrievable through the vehicle's ECU, or when the specific VIN is unknown, you can manually select the vehicle.

This mode of vehicle selection is menu-driven. Select the manufacturer icon on the Vehicle Menu screen and the Select Diagnostic Type screen appears. Tap the **Manual Selection** button. Select the vehicle information (e.g., the series, model, engine, type,

and emission) on the same screen. Tap **Reset** or **ESC** to reselect the vehicle information, if needed.

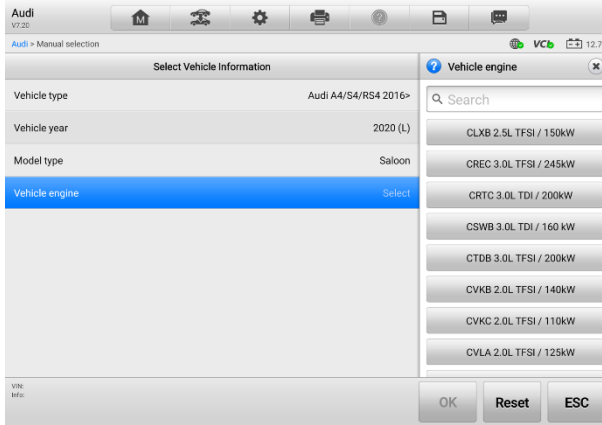

Figure 4-8 Manual Vehicle Selection Screen

4.1.3.5 Alternative Vehicle Identification

Occasionally, the tablet may not be able to identify a vehicle. For these vehicles, the user may perform a generic OBDII or EOBD diagnostics. See [Generic OBDII Operations](#) for additional information.

4.2 Diagnostics Screen Layout

After the vehicle information is selected, tap the **OK** button at the bottom-right corner of the screen to open the Main Menu screen. This section consists of various functions commonly used, including Auto Scan and Control Unit. The available functions displayed vary by vehicle.

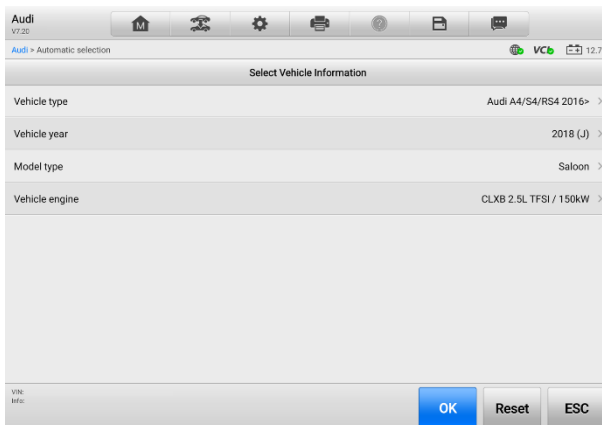

Figure 4-9 Select Vehicle Information Screen

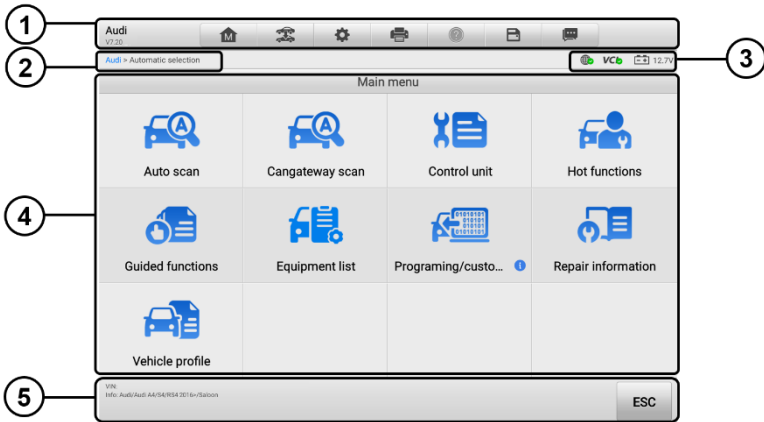







Figure 4-10 Main Menu Screen



1. Diagnostics Toolbar
2. Current Directory Path
3. Status Information Bar
4. Main Section
5. Function Buttons

Diagnostics Toolbar

The Diagnostics Toolbar contains buttons that allow you to print or save the displayed data and perform other operations. The table 4-2 provides a brief description for the operations of the diagnostics toolbar buttons.

Table 4-2 Diagnostics Toolbar Buttons

Button	Name	Description
	Home	Returns to the MaxiSys Job Menu.
	Vehicle Swap	Exits the diagnostics session and returns to the Vehicle Menu screen to select another vehicle for testing.
	Settings	Opens the Settings screen. See Settings .
	Print	Saves and prints a copy of the displayed data. See Printing Settings .
	Help	Provides instructions or tips for operations of various diagnostics functions.

Button	Name	Description
	Save	<p>There are three ways to save data:</p> <ul style="list-style-type: none"> • Tap Screenshot to save an image of the current screen. • Tap Save as PDF to save a PDF file (use this option when data displays on multiple screens). • Tap Report to Cloud to save reports for cloud sharing. <p>These files are stored in Data Manager application for later review. See Data Manager.</p>
	Data Logging	<p>Records the communication data and ECU information of the vehicle. The saved data can be reported and sent to the technical center via the internet.</p> <p>You can go to the Support application to follow up the processing progress. See Data Logging.</p>

 **NOTE**

The Diagnostics Toolbar buttons (located on the top of the screen) will be active throughout the diagnostics session for such tasks as printing and saving the displayed data, obtaining help information or performing data logging.

➤ **To print data in Diagnostics**

1. Tap the **Diagnostics** application button on the MaxiSys Job Menu. The **Print** button in the diagnostics toolbar is available throughout the whole diagnostics operations.
2. Tap **Print** and a drop-down menu displays.
 - **Print This Page** — prints a screenshot of the current screen.
 - **Print All Data** — prints a PDF copy of all displayed data.
3. A temporary file will be created and sent via the computer to the printer.
4. When the file is sent, a confirmation message displays.

 **NOTE**

Make sure the tablet and the printer are connected either by Wi-Fi or LAN before printing. For more instructions on printing, see [Printing Settings](#).

➤ **To submit Data Logging reports in Diagnostics**

1. Tap the **Diagnostics** application button on the MaxiSys Job Menu. The **Data Logging** button on the diagnostics toolbar is available throughout the whole diagnostics operations.

2. Tap the **Data Logging** button to display the error options. Select a specific error and tap **OK**. A submission form will display to let you fill in the report information.
3. Tap **Send** to submit the report form via the Internet. A confirmation message displays when sending is successful.

Current Directory Path

The Directory Path shows all directory names to access the current screen.

Status Information Bar

The Status Information Bar at the top of the Main Section displays the following items:

1. **Network Icon** — indicates whether a network is connected.
2. **VCI Icon** — indicates the communication status between the tablet and VCI.
3. **Battery Icon** — indicates the battery status of the vehicle.

Main Section

The Main Section of the screen varies depending on the stage of operations. The Main Section can show vehicle identification selections, the main menu, test data, messages, instructions, and other diagnostics information.

Function Buttons

The Function Buttons vary depending on the stage of operations. They can be used to navigate, save or clear the diagnostic data, exit scanning as well as make other controls. The functions of these buttons will be described in the following sections when relevant.

4.2.1 Screen Messages

Messages appear when additional input is needed before proceeding. There are mainly three types of on-screen messages: Confirmation, Warning, and Error.

✧ **Confirmation Messages**

This type of message usually appears as an "Information" screen, when you are about to perform an action that cannot be reversed or when an action has been initiated and your confirmation is needed to continue.

When a user-response is not required, the message displays briefly.

✧ **Warning Messages**

This type of message appears when completing the selected action may result in an irreversible change or loss of data. An example of this message is the "Erase Codes" message.

❖ Error Messages

Error messages appear when a systemic or procedural error has occurred. Possible errors include cable disconnection and communication interruption.

4.2.2 Making Selections

The Diagnostics application is a menu-driven program that presents a series of options one at a time. As you select from a menu, the next menu in the series appears. Each selection narrows the focus and leads to the desired test.

4.3 Auto Scan

The Auto Scan function performs a comprehensive scanning of all the systems in the vehicle ECU to locate faults and retrieve DTCs. Tap **Fault Scan** at the bottom of the screen to start.

➤ To perform the Auto Scan function

1. Tap the **Diagnostics** application button on the MaxiSys Job Menu. Choose the corresponding vehicle information and enter the Main Menu screen. (Figure 4-10)
2. Select **Auto Scan** on the Main Menu to enter the diagnostics interface.
3. Tap the **Fault Scan** button at the bottom of the screen to scan the vehicle system modules.

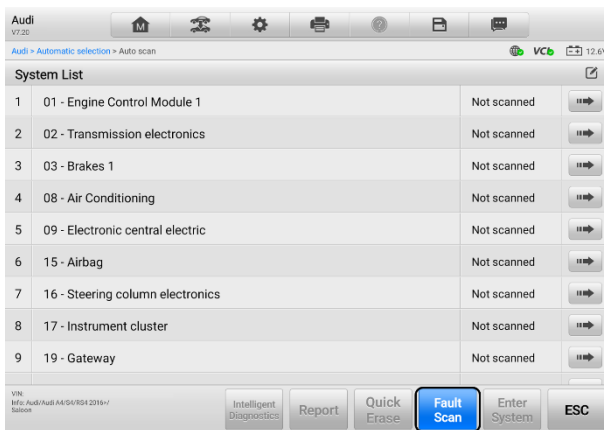



Figure 4-11 Auto Scan Screen

📌 NOTE

On the Auto Scan screen, there is a **Select System** icon  on the upper-right corner. Select the corresponding system(s) to scan will save more time than scanning all systems.

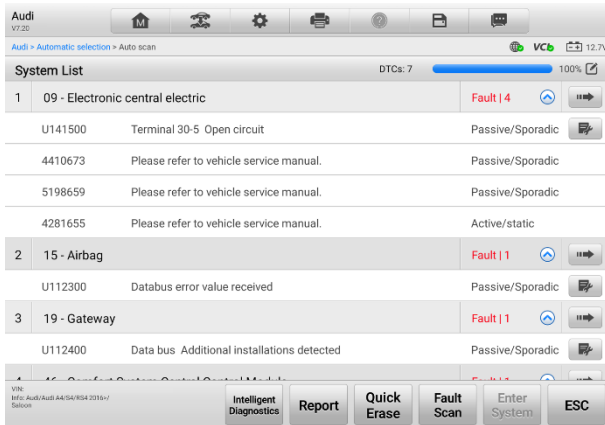

Figure 4-12 Auto Scan Results Screen

4. The results are displayed on the screen. The quantity of total faults will appear on the upper-right corner.

Column 1 — displays the system numbers.

Column 2 — displays the scanned systems.

Column 3 — displays the scan results.

- ◇ **-?-:** Indicates that the vehicle control system has been detected, but the tablet cannot access it.
- ◇ **Fault | #:** Indicates there is/are fault code(s) detected; “#” indicates the quantity of detected faults.
- ◇ **Pass | No Fault:** Indicates the system was scanned and no faults has been detected.
- ◇ **Not Scanned:** Indicates the system has not been scanned.
- ◇ **No Response:** Indicates the system has not received a response.

Column 4 — tap to enter the corresponding system.

The table 4-3 provides a brief description of how the function buttons in Auto Scan operate:

Table 4-3 Function Buttons in Auto Scan

Name	Description
Intelligent Diagnostics	Directly accesses the Intelligent Diagnostics function to view the fault code analysis information. See Intelligent Diagnostics Operation .
Report	Displays the diagnostic data in the report form.

Name	Description
Quick Erase	Erases all faults after scanning.
Fault Scan	Scans vehicle system modules.
Pause	Pauses the scanning process.
Enter System	Enters the ECU system.
ESC	Returns to the previous screen or exits the Diagnostics Screen.

Select one of the system modules from System List screen and tap **Enter System** to enter the specific system functions.

4.4 Control Unit

The Control Unit function allows you to manually locate a required control system for testing through a series of choices. Follow the menu-driven procedure, the program will guide you to the Function Menu screen.

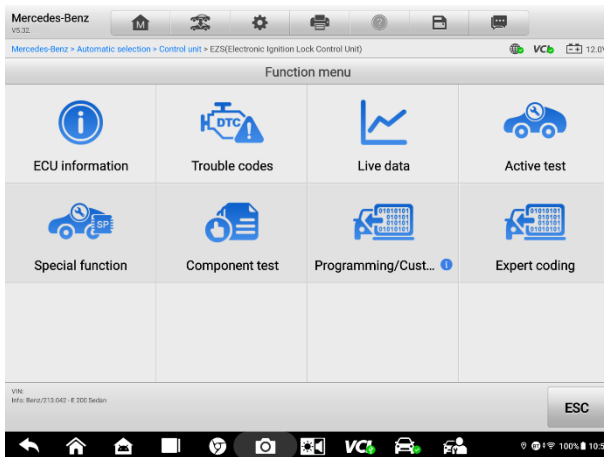

Figure 4-13 Function Menu Screen

Available functions may vary by vehicle. The function menu may include:

- **ECU Information** — displays detailed ECU information. Select to display information screen.
- **Trouble Codes** — contains Read Codes and Erase Codes. The former displays detailed DTC information retrieved from the vehicle control module. The latter allows you to erase DTCs and other data from the ECU.
- **Live Data** — retrieves and displays live data and parameters from the vehicle's ECU.

- **Active Tests** — provides specific subsystem and component tests. This selection may display as *Actuators*, *Actuator Test* or *Function Tests*. Available tests vary by vehicle.
 - **Special Functions** — provides various component adaptations.
 - **Coding** — reprograms adaptive data for vehicle control modules.
 - **Programming** — downloads the latest software from the online server database through Internet access and reprograms the newest version into the vehicle's ECU.
- **To perform a diagnostic function**
1. Establish communication with the test vehicle.
 2. Identify the test vehicle by selecting from the menu options.
 3. Locate the required system for testing by tapping **Auto Scan** or through menu-driven selections in **Control Unit**.
 4. Select the desired diagnostic function from the Function Menu screen.

4.5 ECU Information

This function retrieves and displays the specific information for the tested control unit, including unit type and version numbers.

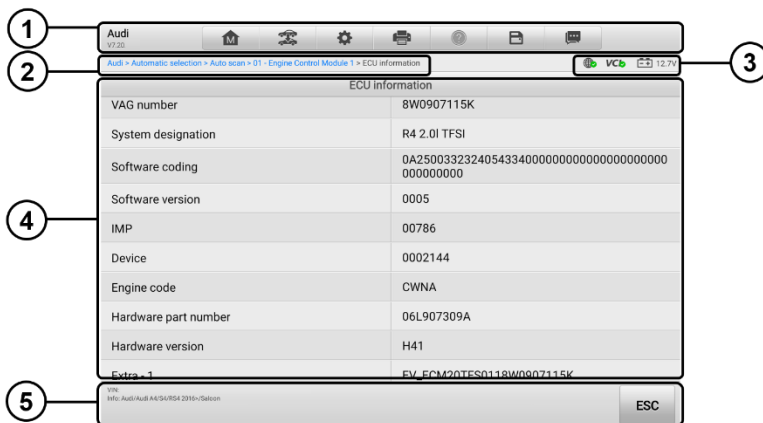

Figure 4-14 ECU Information Screen

1. Diagnostics Toolbar Buttons — see [Table 4-2 Diagnostics Toolbar Buttons](#) for detailed descriptions of the operations of each button.
2. Current Directory Path
3. Status Information Bar
4. Main Section — the left column displays the item names; the right column displays the specifications or descriptions.

- Function Button — in this case, only the **ESC** button is available. Tap it to exit after viewing.

4.6 Trouble Codes

4.6.1 Read Codes

This function retrieves and displays DTCs from the vehicle control system. The Read Codes screen varies for each vehicle being tested. For some vehicles, freeze frame data can also be retrieved for viewing.

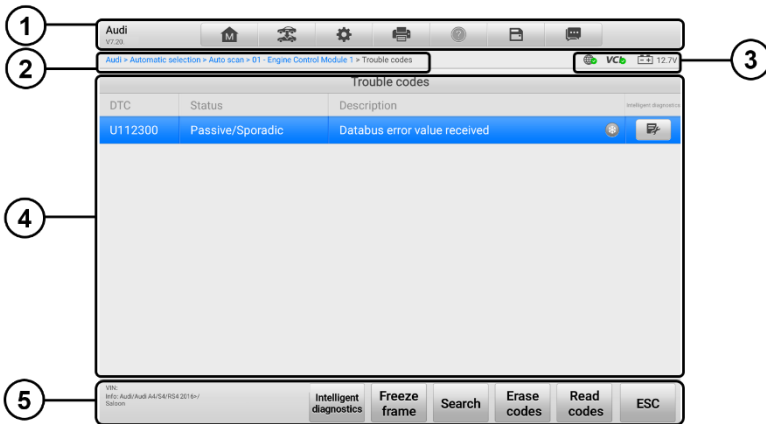

Figure 4-15 Read Codes Screen

- Diagnostics Toolbar — see [Table 4-2 Diagnostics Toolbar Buttons](#) for details.
- Current Directory Path
- Status Information Bar
- Main Section
 - Column 1 — displays the retrieved codes from the vehicle.
 - Column 2 — indicates the status of the retrieved codes.
 - Column 3 — detailed descriptions for the retrieved codes.
 - Column 4 — provides access to the Intelligent Diagnostics screen.
- Function Buttons
 - Intelligent Diagnostics** — enters the Intelligent Diagnostics screen to check related repair cases and help information.
 - Freeze Frame** — 📄 icon displays when freeze frame data is available for viewing. Tap the icon to display the data screen. The Freeze Frame screen is similar to the

Read Codes interface and shares similar operations.

- **Search** — searches the selected DTC for additional information on the Internet.
- **Erase codes** — erases codes from the ECU. It is recommended that DTCs are read and needed repairs are performed before erasing codes.
- **Read codes** — retrieves and displays the DTCs from the vehicle control system. The Read Codes screen varies for each vehicle being tested.
- **ESC** — returns to the previous screen or exit the function.

4.6.2 Erase Codes

After reading the retrieved codes from the vehicle and certain repairs have been made, you can erase the codes from the vehicle using this function. Before performing this function, make sure the vehicle's ignition key is in the ON (RUN) position with the engine off.

➤ To erase codes

1. Tap **Erase Codes** in the function buttons.
2. A warning message appears to inform you of data loss when this function is applied.
 - a) Tap **Yes** to continue. A confirmation screen appears when the operation is successfully done.
 - b) Tap **No** to exit.
3. Tap **ESC** on the confirmation screen to exit Erase Codes.
4. Perform the Read Codes function again to ensure the operation is successful.

4.7 Live Data

When this function is selected, the screen displays the data list for the selected module. The parameters appear in the order that they are transmitted by the ECU, so expect variation among vehicles.

Gesture scrolling allows you to quickly move through the data list. Drag your finger up or down on the screen to reposition the parameters being displayed if the data occupies more than one screen. The figure below displays a typical Live Data screen:

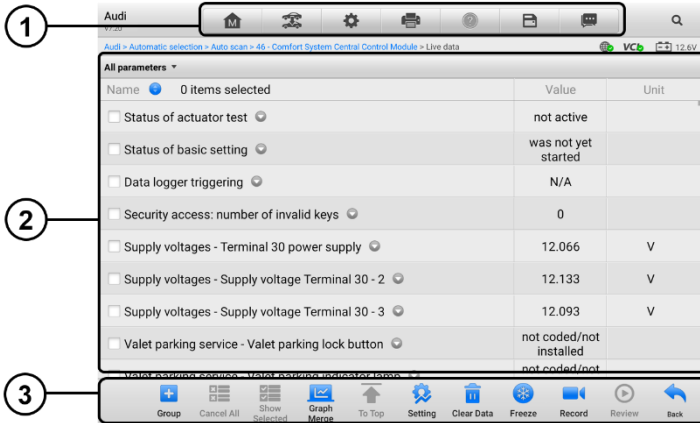

Figure 4-16 Live Data Screen

1. **Diagnostics Toolbar Buttons** — see [Table 4-2 Diagnostics Toolbar Buttons](#) for detailed descriptions of each button.

2. Main Section

- Name Column — displays the parameters.
 - a) Check Box — tap the check box to the left of a parameter to select the item. Tap the check box again to deselect it.
 - b) Drop-down Button — tap the drop-down button on the right of a parameter to open a submenu, which provides optional modes that display the data.
- Value Column — displays the values of the parameters.
- Unit Column — displays the units of the parameters. To change the Unit mode, tap the **Settings** button in the top toolbar and select a required mode. See [Unit](#).

Display Mode

There are four display modes available for data viewing, allowing you to view various parameters in the mode best suited to represent the data.

Tap the drop-down button on the right of a parameter to open a submenu. A total of 7 buttons will be displayed: The 4 buttons on the left represent different data display modes, plus an **Information** button (active when additional information is available), an **Unit Change** button (for switching the unit of the displayed data), and a **Trigger** button (tap to open the "Trigger Settings" window).

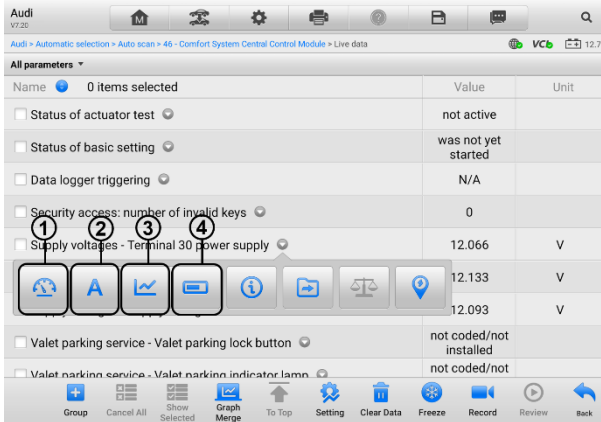

Figure 4-17 Display Mode Screen

Each parameter displays the selected mode independently.

- ① **Analog Gauge Mode** — displays the parameters in gauge charts.
- ② **Text Mode** — the default mode that displays the parameters as a text list.

NOTE

Some status parameters, such as a switch reading like ON, OFF, ACTIVE, and ABORT, can only be displayed in Text Mode. Others, such as a sensor reading, can be displayed in both text and graph modes.

- ③ **Waveform Graph Mode** — displays the parameters in waveform graphs.

In this mode, five control buttons will appear on the right of the parameter, allowing you to manipulate the displayed status.

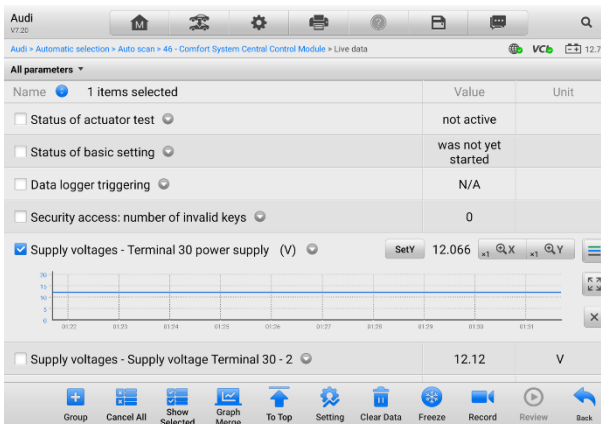

Figure 4-18 Waveform Graph Mode Screen

- **Settings (SetY)** — sets the minimum and maximum value of the Y-axis.

- Scale — changes the scale values.

There are two scale buttons displaying above the waveform graph on the right, which can be used to change the scale values of the X-axis and Y-axis of the graph. There are four scales available for the X-axis: x1, x2, x4, and x8. Three scales available for the Y-axis: x1, x2, and x4.

- Edit — tap to edit the waveform color and the line thickness.
- Zoom-in — tap once to display the selected data graph in full screen.
- Exit — tap to exit the waveform graph mode.

Full Screen Display — this option is only available in the waveform graph mode, and is mostly used in Graph Merge status for data comparison. There are three control buttons available on the top-right corner of the screen under this mode.

- Scale — tap to change the scale values below the waveform graph. There are four scales available for the X-axis: x1, x2, x4, and x8. There are three scales available for the Y-axis: x1, x2, and x4.
- Edit — tap to open an edit window, in which you can set the waveform color and the line thickness displayed for the selected parameter.
- Zoom-out — tap to exit full screen display.
- Exit — tap to exit the waveform graph mode.

➤ **To edit the waveform color and line thickness in a data graph**

1. Select a parameter to display in Waveform Graph mode.
2. Tap the **Edit** button and an edit window will appear.

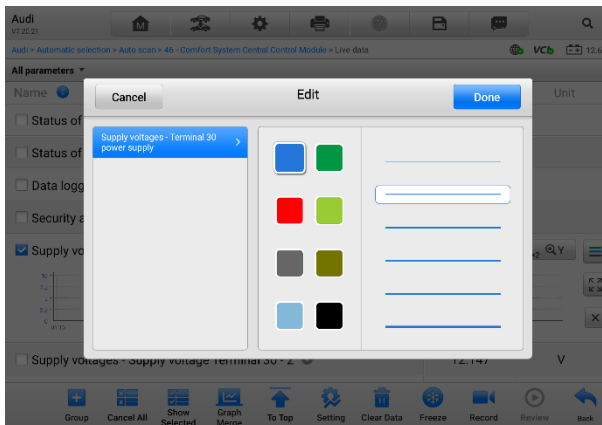

Figure 4-19 Waveform Edit Screen

3. The parameter is selected automatically in the left column.
4. Select a color from the middle column.
5. Select a line thickness from the right column.
6. Tap **Done** to save the settings and exit or tap **Cancel** to exit without saving.

NOTE

In the full screen display, edit the waveform color and the line thickness by tapping the **Edit** button on the upper-right side of the screen.

④ **Digital Gauge Mode** — displays the parameters in the form of a digital gauge graph.

Trigger Settings

On the Trigger Settings screen, you can set a standard range by filling in the minimum value and maximum values. When exceeding these values, the trigger function will be executed and the device will automatically record and save the generated data. You can review the saved live data by tapping the **Review** button at the bottom of the screen.

Tap the drop-down button on the right of a parameter to open a submenu. The **Trigger** button is the last one in the submenu. Tap to display the Trigger Settings window.

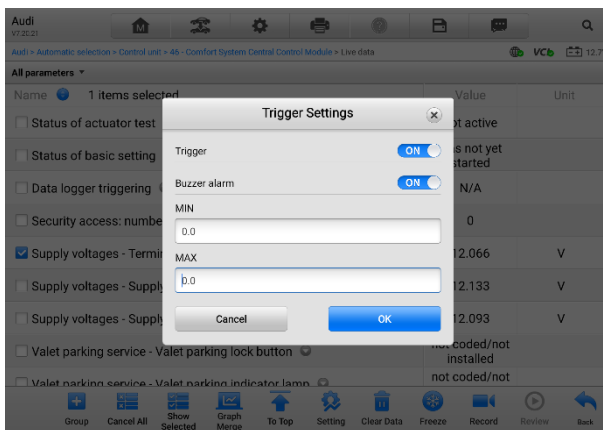

Figure 4-20 Trigger Settings Screen

Two buttons and two input boxes are available in the Trigger Settings dialog box.

- a) **Trigger On** — toggles the trigger on and off. The trigger is **ON** by default.
- b) **Buzzer Alarm** — switches the alarm on and off. The alarm function makes a beeping sound as an alert when the data reading reaches the preset minimum or maximum point. The buzzer alarm will only sound at the first trigger.
- c) **MIN** — displays a virtual keyboard to enter a lower threshold value.

d) **MAX** — displays a virtual keyboard to enter an upper threshold value.

➤ **To set a trigger**

1. Tap the drop-down button on the right side of the parameter to open a submenu.
2. Tap the **Trigger** button on the right side of the submenu to open the Trigger Settings window.
3. Tap the **MIN** input box and enter the required minimum value.
4. Tap the **MAX** input box and enter the required maximum value.
5. Tap **OK** to save the settings and return to the Live Data screen, or tap **Cancel** to exit without saving.

When the trigger is set, a trigger mark appears in front of the parameter. The mark is gray when it is not triggered, and turns orange when triggered. Moreover, two horizontal lines appear on each of the data graphs (when Waveform Graph Mode is applied) to indicate the alarm point. The threshold lines are shown in different colors to differentiate them from the waveforms.

3. Function Buttons

The operations of all available function buttons on the Live Data screen are described below:

- ✦ **Group** — customizes the groups. Put the needed live data into the groups defined by the users themselves.
- ✦ **Cancel All** — cancels all selected parameters.
- ✦ **Show Selected/Show All** — switches between the two options; one displays the selected parameters, the other displays all the available items.
- ✦ **Graph Merge** — merges selected data graphs (for Waveform Graph Mode only). This function is very useful when comparing different parameters.

🔗 **NOTE**

This mode supports the merging of 2 to 5 parameters from different graphs. Only quantitative parameters are supported.

➤ **To merge selected data graphs**

1. Select parameters to be merged.
2. Tap the **Graph Merge** button at the bottom of the Live Data screen.
 - a) This mode only supports parameters that can be represented digitally. If non-digital parameters are selected, a message will display advising the user that the selected parameters are not supported in this mode and to

select 2 to 5 digital parameters. Tap the **Got It** button to return to the previous screen and select supported parameters.

- b) When unsupported parameters are selected, a message will appear advising the user to selected only parameters that are supported.
- c) A message will also appear if more than 5 parameters have been selected. Please select 2 to 5 of the supported parameters and tap the **OK** button to merge.

3. Tap the **Cancel Merging** button at the bottom of the Live Data screen to cancel merging.

❖ **To Top** — moves a selected data item to the top of the list.

❖ **Setting** — sets recording duration.

➤ **To set live data record duration**

1. Tap **Setting** button at the bottom of the Live Data screen.
2. Tap the > button to the right of **Recording time after trigger** bar and select a time length.
3. Tap **OK** to save the settings and return to the Live Data Setting screen or tap the “**X**” button at the upper-right corner to exit without saving.
4. Tap **Done** at the upper-right corner of the Live Data Setting screen to confirm and save the settings and return to the Live Data screen or tap **Cancel** to exit without saving.

❖ **Clear Data** — clears all cached live data.

❖ **Freeze** — displays the retrieved data in freeze mode.

- Previous Frame — moves to the previous frame of the frozen data.
- Next Frame — moves to the next frame of the frozen data.
- Play/Pause — plays/pauses the frozen data.
- Resume — exits the freeze data mode and returns to normal data display.

❖ **Record** — starts recording the live data of the selected data items. Tap the **Record** button at the bottom of the Live Data screen. A message will display prompting user to select parameters to record. Tap the **Got It** button to confirm. Scroll down and select data to record. Tap the **Record** button to start recording. Tap the **Resume** button to stop recording. The recorded live data can be viewed in the **Review** section at the bottom of the Live Data screen or in the Data Manager application.

- Resume — stops data recording and returns to normal data display.
- Flag — appears when the Record function is applied. Tap this button to set flags to note points of interest when recording data. Notes can be added during

playback in Review or Data Manager. Select the preset flag to open a popup window and display a virtual keyboard to input notes.

- ✧ **Review** — reviews the recorded data. Tap **Review** to display a recording list and select one item to review.

NOTE

Only the data recorded during the current operation can be reviewed on the Live Data screen. All the historical recorded data can be reviewed in Review Data in the Data Manager application.

- Previous Frame — switches to the previous frame of the recorded data.
- Next Frame — switches to the next frame of the recorded data.
- Play/Pause — plays/pauses the recorded data.
- Show Selected — displays the selected parameters.
- Graph Merge — merges selected data graphs.
- Back — exits the review and returns to the Live Data screen.

- ✧ **Back** — returns to the previous screen or exits the function.

4.8 Active Test

The Active Test function is used to access vehicle-specific subsystem and component tests. Available tests vary by vehicle.

During an active test, the tablet sends commands to the ECU to activate the actuators. This test determines the integrity of the system or part by reading ECU data or by monitoring the operation of the actuators. Such tests may include toggling a solenoid, relay, or switch, between two positions.

Selecting Active Test displays a menu of test options. Available tests vary by vehicle.

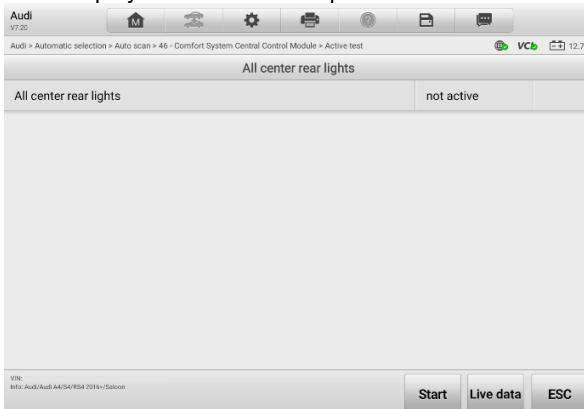

Figure 4-21 Active Test Screen

Select a test from the menu options. Follow the instructions displayed on the screen to complete the test. Procedures and instructions vary by vehicle.

The function buttons in the lower-right corner of the Active Test screen manipulate the test signals. The operational instructions are displayed in the main section of the test screen. Follow the on-screen instructions and make appropriate selections to complete the tests. Tap the **ESC** button to exit the test when finished.

4.9 Special Functions

These functions perform various component adaptations, including the recalibration or configuration of certain components after repairs or replacements have been completed.

Select a function to display detailed information and the execution screen. Tap the function buttons to perform the selected function or exit the function.

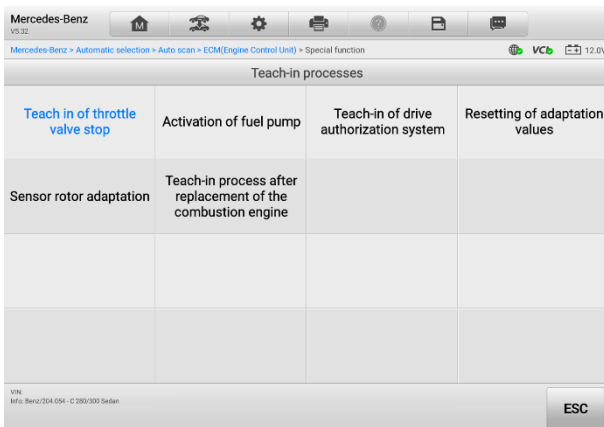

Figure 4-22 Special Function Screen 1

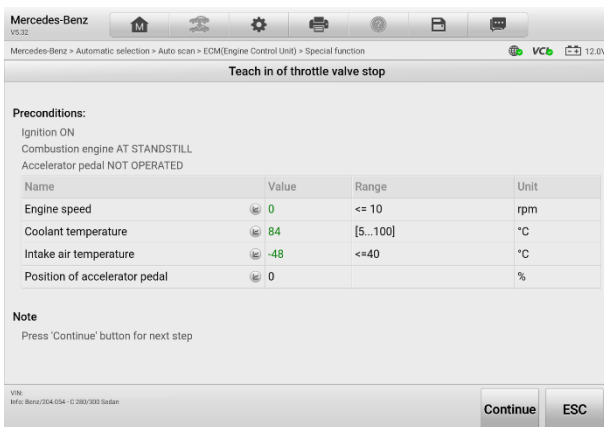

Figure 4-23 Special Function Screen 2

4.10 Programming and Coding

Since the introduction of the OBDII and leading up to modern hybrids and EVs, hardware and software technologies in cars have been advancing at an exponential rate. Updating software may be the only way to fix the following issues:

- Drivability
- Fuel Efficiency
- Power Loss
- Fault Codes
- Durability of Mechanical Parts

The Programming and Coding function is used to “re-flash” the vehicle control modules, which allows you to update the computer software of the vehicle to the latest version, as well as to reprogram adaptive data of certain components after making repairs or replacements.

NOTE

The programming function applies only when the vehicle is connected with a VCI, which serves as a PassThru interface to establish communication and transfer data to the vehicle's ECU.

Available programming or coding operations vary by test vehicle. Only the available operations display in the tablet menu.

There are two general types of programming operations:

- A. Coding — also known as *Teach-in Program* or *Component Adaptation*, is used to reprogram adaptive data for vehicle control modules after repairs or replacements of vehicle parts.
- B. Reprogramming — downloads the latest version of software from the online server database via the Internet access (this procedure is done automatically when the tablet is connected to the Internet, so there is no need to check for software updates yourself), and reprograms the newest version into the vehicle's ECU.

NOTE

Ensure that the tablet is connected to a stable Internet access before launching the ECU programming function, so that the tablet is able to access the vehicle manufacturer's server for update service.

Selecting the Programming or Coding function opens a menu of operation options that varies by vehicle make and model. Selecting a menu option either displays a programming interface or opens another menu of additional choices. Follow all on-screen instructions while performing the programming or coding operations. How and what information is presented on the screen vary by the type of operation being performed.

a module.

- Do not quit the application during a module programming as the process may fail and may also result in permanent damage to the module.

Typical reprogramming operations require you to input and validate the VIN number first. Tap the input box and enter the correct number. The programming interface then appears.

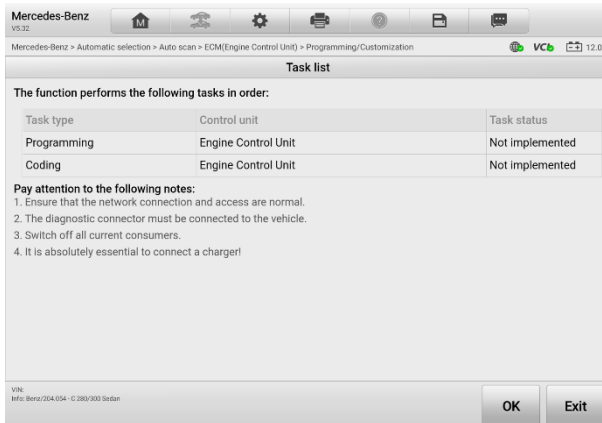

Figure 4-25 Reprogramming Operation Screen

The main section of the reprogramming interface offers information about the hardware, the current software version, and the newest software versions to be programmed into the control units. A series of on-screen operational instructions will display to guide you through the programming procedure.

Carefully read the on-screen information and follow the instructions to execute the programming procedure.

4.10.3 Re-flash Errors

! IMPORTANT

When reprogramming onboard, always make sure the vehicle battery is fully charged and in good working condition. During reprogramming, the operation may fail if voltage falls below the proper operation voltage. Sometimes a failed operation can be recovered, but the failed reprogramming can also ruin the control module. We recommend connecting an external battery maintainer to the vehicle to ensure a steady voltage is maintained throughout programming. The required voltage differs by vehicle manufacturer. Consult vehicle manufacturer for correct voltage to be maintained.

Occasionally a flash update procedure may not be completed properly. Common causes of flash errors include poor cable connections between the tablet, VCI, and vehicle, the vehicle ignition being switched off before the flash procedure is completed, or low vehicle battery voltage.

If the process quits, recheck all the cable connections to assure good communications and initialize the flash procedure. The programming procedure will automatically repeat if the previous operation does not succeed.

4.11 Generic OBDII Operations

The OBDII vehicle diagnosis option offers a quick way to check for DTCs, isolate the cause of an illuminated Malfunction Indicator Lamp (MIL), check monitor status prior to emissions certification testing, verify repairs, and perform other emissions-related services. The OBDII direct access option is also used for testing OBDII-compliant vehicles that are not included in the diagnostics database. Diagnostics toolbar buttons at the top of the screen are available for specific vehicle diagnostics. See [Table 4-2 Diagnostics Toolbar Buttons](#) for details.

4.11.1 General Procedure

➤ **To access the OBDII diagnostics functions**

1. Tap the **Diagnostics** button on the MaxiSys Job Menu. The Vehicle Menu appears.
2. Tap the **EOBD** button. There are two options to establish communication with the vehicle.
 - Auto Scan — select to establish communication using each protocol in order to determine which one the vehicle is using.
 - Protocol — select to open a submenu of various protocols. A communication protocol is a standardized way of data communication between an ECM and a diagnostics tool. Global OBD may use several different communication protocols.
3. Select a specific protocol if the **Protocol** option is selected. Wait for the OBDII Diagnostic Menu to appear.

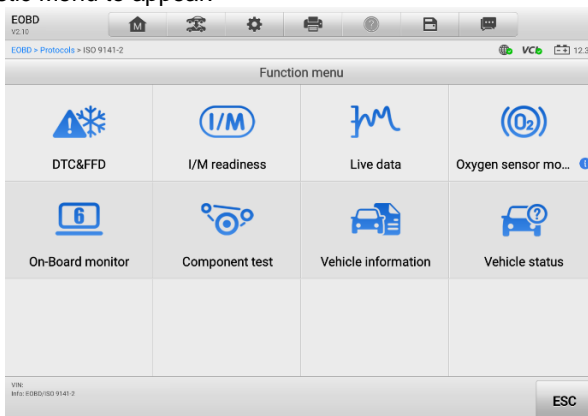

Figure 4-26 OBDII Diagnostic Menu Screen

4. Select a function to continue.

- DTC & FFD
- I/M Readiness
- Live Data
- Oxygen Sensor Monitor
- On-Board Monitor
- Component Test
- Vehicle Information
- Vehicle Status

NOTE

Supported functions may vary by vehicle.

4.11.2 Function Descriptions

This section describes various functions of each diagnostics option.

4.11.2.1 DTC & FFD

When this function is selected, the screen displays a list of Current Codes and Pending Codes. When the Freeze Frame data of certain DTCs are available for viewing, a snowflake button will display on the right side of the DTC item. The Erase Codes function can be applied by tapping the function button at the bottom of the screen.

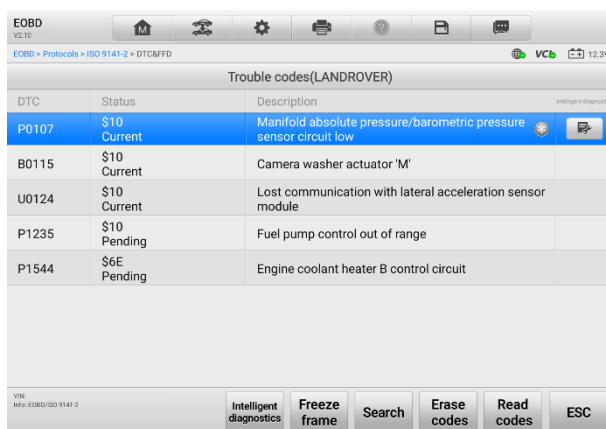



DTC	Status	Description	Intelligent diagnostics
P0107	\$10 Current	Manifold absolute pressure/barometric pressure sensor circuit low	 
B0115	\$10 Current	Camera washer actuator 'M'	
U0124	\$10 Current	Lost communication with lateral acceleration sensor module	
P1235	\$10 Pending	Fuel pump control out of range	
P1544	\$6E Pending	Engine coolant heater B control circuit	

Figure 4-27 DTC & FFD Screen

- **Current Codes**

Current codes are emissions-related DTCs from the ECU of the vehicle. OBDII codes are prioritized according to their emissions severity, with higher-priority codes overwriting lower-priority ones. The priority of the code determines the illumination of the Malfunction Indicator Lamp (MIL) and the codes erase procedure. Manufacturers rank codes differently, so DTCs may vary by vehicle.

- **Pending Codes**

These are codes whose storing conditions have been met during the last drive cycle, but need to be met on two or more consecutive drive cycles before the DTC stored. The purpose of displaying pending codes is to assist the service technician after a vehicle repair when diagnostic information is cleared, by reporting test results after a single driving cycle.

- a) If a test fails during the driving cycle, the DTC associated is reported. If the pending fault does not occur again within 40 to 80 warm-up cycles, the fault is automatically cleared from memory.
- b) Test results reported do not necessarily indicate a faulty component or system. If test results indicate another failure after additional driving, a DTC is stored to indicate a faulty component or system.

- **Freeze Frame**

In most cases the stored frame is the last DTC reported. Certain DTCs — those that have a greater impact on vehicle emission — have a higher priority. In these cases, DTC of the highest priority is the one for which the freeze frame records are retained. Freeze frame data includes a “snapshot” of critical parameter values at the time the DTC is stored.

- **Erase Codes**

This option is used to clear all emissions-related diagnostics data including DTCs, freeze frame data, and specific manufacturer-enhanced data from the vehicle ECU. This option resets the I/M Readiness Monitor Status for all vehicle monitors to Not Ready or Not Complete status.

A confirmation screen displays when the clear codes option is selected to prevent accidental loss of data. Tap **Yes** on the confirmation screen to continue or **No** to exit.

4.11.2.2 I/M Readiness

This function is used to check the readiness of the monitoring system. It is an excellent function to use prior to having a vehicle inspected for state emissions compliance. Selecting **I/M Readiness** opens a submenu with two choices:

- ✦ Since DTCs Cleared — displays the status of monitors since the last time the DTCs

were erased.

- ✧ This Driving Cycle — displays the status of monitors since the beginning of the current drive cycle.

4.11.2.3 Live Data

This function enables the display of real-time PID data from the ECU. Displayed data includes analog and digital input and output, and system status information broadcast in the vehicle data stream.

Live data can be displayed in various modes, see [Live Data](#) for detailed information.

4.11.2.4 Oxygen Sensor Monitor

This function allows retrieval and review of recent oxygen sensor monitor test results stored on the vehicle on-board computer.

The Oxygen Sensor Monitor test function is not supported by vehicles that communicate using a controller area network (CAN). For Oxygen Sensor Monitor tests results of CAN-equipped vehicles, refer to [On-Board Monitor](#).

4.11.2.5 On-Board Monitor

This function allows you to view the results of On-Board Monitor tests. The tests are useful after the service when a vehicle control module memory is already erased.

4.11.2.6 Component Test

This function enables dual-directional control of the ECU so that the diagnostics tool can transmit control commands to operate the vehicle systems. This function is useful in determining how well the ECU responds to a command.

4.11.2.7 Vehicle Information

This function enables the display of the vehicle identification number (VIN), calibration identification number, calibration verification number (CVN), and other information of the test vehicle.

4.11.2.8 Vehicle Status

This function checks the current condition of the vehicle, such as the communication protocols of OBDII modules, number of fault codes, and status of the Malfunction Indicator Lamp (MIL).

4.12 Diagnostics Report

4.12.1 Pre-Scan and Post-Scan

➤ **To perform the pre-scan and post-scan functions**

1. Auto Scan the Vehicle — the Auto VID function can automatically identify the vehicle and its equipped systems. All available modules in all systems will be scanned automatically. Codes and their details will be listed.
2. Print Pre-scan Report — vehicle images can be taken with the tablet and attached to scan report. The report file can be generated and submitted. The report can be customized with shop and vehicle information.
3. Repair Vehicle — creates efficient repair plan from the start.
4. Auto Scan Repaired Vehicle — ensures no new faults were created during repair and no DTCs are present at completion.
5. Print Post-scan Report — proves all DTCs on pre-scan report are fixed.

4.12.2 Diagnostics Report Saving, Viewing, and Sharing

Diagnostics reports can be reviewed, saved, and shared with others in many ways.

4.12.2.1 Diagnostics Report Saving

a) Via the **History** function

- ❖ Tap **Diagnostics** on the MaxiSys Job Menu and tap **History** in the Top Toolbar.

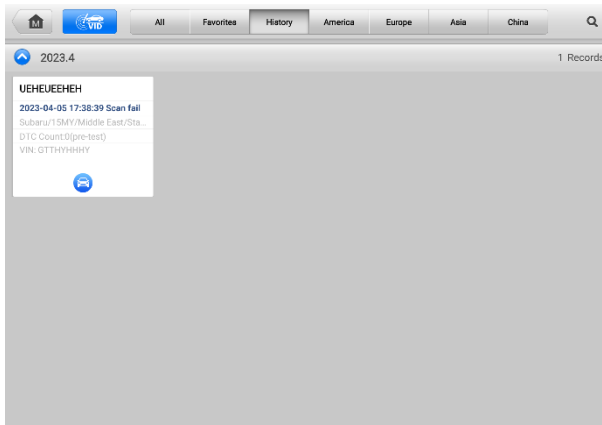

Figure 4-28 History Screen

- ❖ Select a history record and tap the **⋮** button on the upper-right corner to view the PDF document, print, email or delete the historical test.

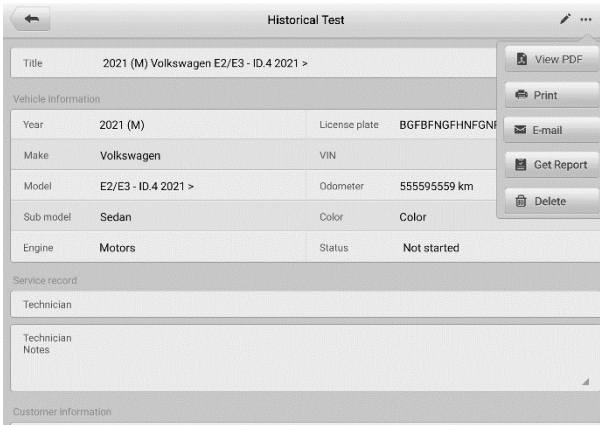

Figure 4-29 Historical Test Screen

- ✦ Tap **View PDF** to view the report directly. Or tap **Get Report**, enter the license plate and current mileage, and then tap **Save > View Report** to save and view the report.

b) Via the **Auto Scan** function

- ✦ Enter the Auto Scan page and tap **Fault Scan** at the bottom of the screen.

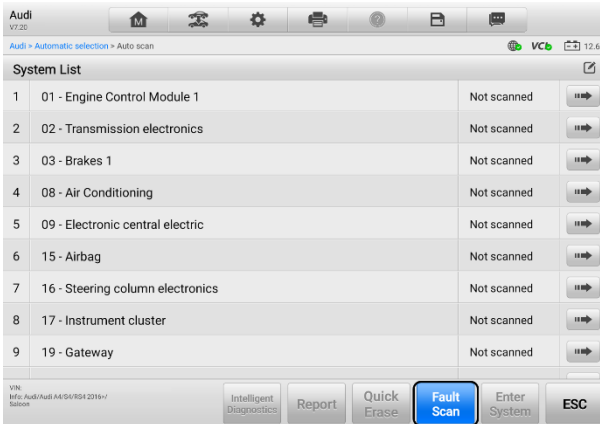

Figure 4-30 Auto Scan Screen 1

- ✦ When the system scan is completed, tap **Report** in the Function Button Bar at the bottom of the screen.

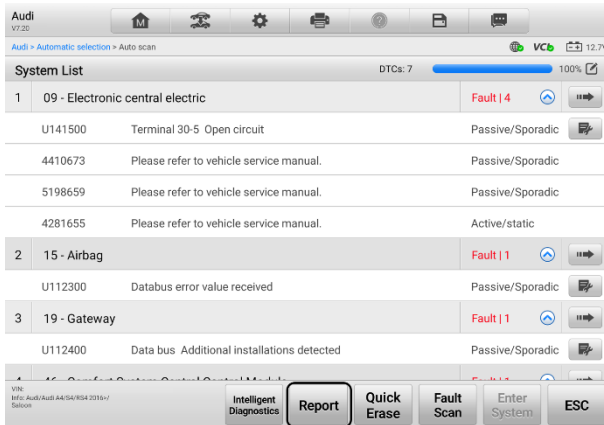

Figure 4-31 Auto Scan Screen 2





- ❖ Tap the  button in the Diagnostics Toolbar and select **Save as PDF**. Enter the license number and tap **Save**. Tap the  button on the upper-right of the screen to view the report.
- ❖ Or tap the  button in the Diagnostics Toolbar and select **Report to Cloud**. Enter the license plate and current mileage. Tap **Save > View Report** and then select a saved report to view.



Figure 4-32 Report Screen

c) Via the functions on the Navigation Bar

- ❖ The diagnostics report can also be viewed from such diagnostics function screens including Auto Scan, Read Codes, Live Data, and Active Test screens. Tap the  button in the Diagnostics Toolbar, and select **Save as PDF** to save the PDF document.

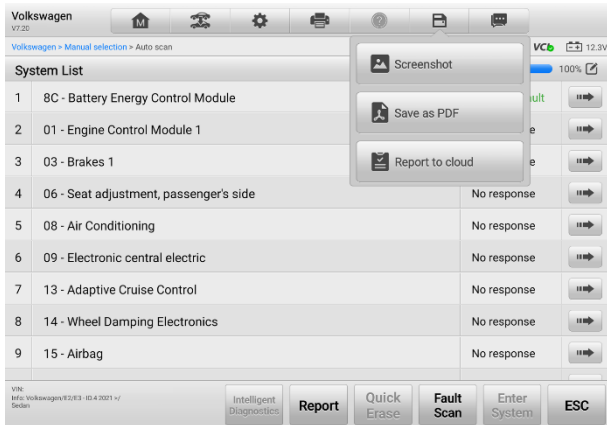

Figure 4-33 Read Codes Screen

4.12.2.2 Diagnostics Reports Viewing

All the saved reports can be viewed in the Data Manger application.

- ✧ Tap **Data Manager > Vehicle History**. Select a specific vehicle history record and then tap **View PDF** in the upper-right corner to view the report.
- ✧ Once you save the reports by tapping the **Save as PDF** button, tap **Data Manager > PDF** to view these local reports.
- ✧ Once you save the reports by tapping the **Get Report** or **Report to Cloud** button, tap **Data Manager > Cloud Report** to view these reports saved to the Autel cloud platform.

4.12.2.3 Diagnostics Report Cloud Sharing

- ✧ Tap **Data Manager > Cloud Report** to enter the Report List screen.

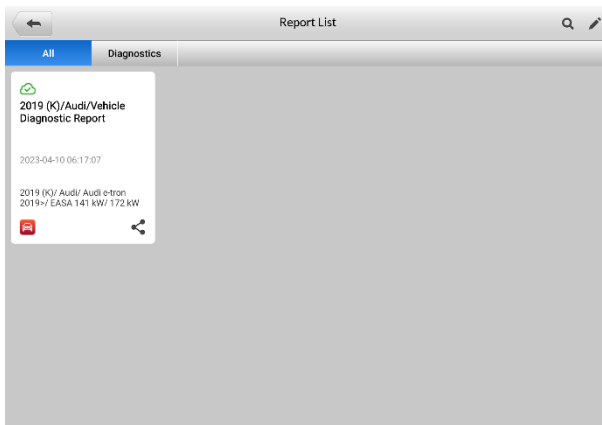





Figure 4-34 Report List Screen

NOTE

Note that if the report displays  , it means the report has been uploaded to the cloud successfully, and you can share the report with others; if the report displays  , it means the report has failed to upload to the cloud, but will try to automatically upload to the cloud when entering the Report again.

- ✧ Choose a report displaying  , then tap the **Share** icon .
- ✧ There are three ways to share reports: scan the QR code, send by email, and send by SMS (via phone number).

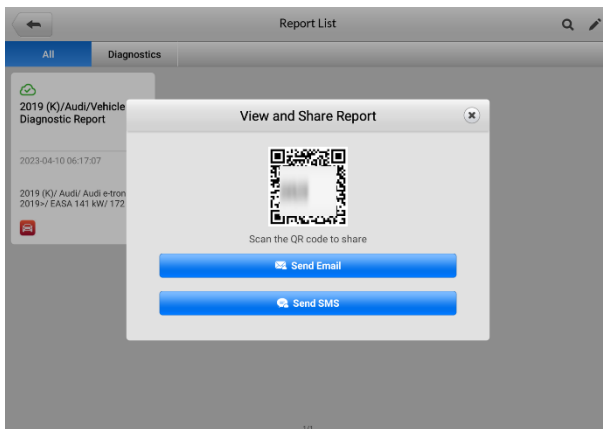

Figure 4-35 Report Sharing Screen

4.13 Exit Diagnostics

The Diagnostics application operates while communication between the tablet and the vehicle is still active. It is important to properly exit from the diagnostics operation interface to stop all communications with the vehicle before closing the Diagnostics application.

NOTE

Damage to the vehicle Electronic Control Module (ECM) may occur if communication is disrupted. Ensure all forms of communication links such as data cable, USB cable, and wireless or wired network, are properly connected throughout the test. Exit all interfaces before disconnecting the test cable and power supply.

- **To exit the Diagnostics application**
 - On an active diagnostic screen
 1. Tap the **Back** or **ESC** button to exit a diagnostic session.
 2. Or tap **Vehicle Swap** button in the diagnostics toolbar to return to the Vehicle Menu screen.

- On the Vehicle Menu screen
 1. Tap the **Home** button in the top toolbar.
 2. Or tap the **Back** button in the navigation bar at the bottom of the screen.
 3. Or tap the **Home** button in the diagnostics toolbar to exit the application directly and return to the MaxiSys Job Menu.

Now, the Diagnostics application is no longer communicating with the vehicle and it is safe to open other MaxiSys applications or exit the MaxiSys Diagnostics System and return to the Home screen.

5 Intelligent Diagnostics

Intelligent Diagnostics is a specific fault code analysis function, with which you can access the most comprehensive and the latest code-specific data, DTC analysis, repair assist, repair tips, and relevant repair cases. It has been drawn from real world shop repair orders and records and with input from experienced industry professionals.

Intelligent Diagnostics adopts the scientific data cloud computing technology to match the specific fault code with the exact vehicle model. And the data has been verified by automotive maintenance professionals.

The following are main parts of the code data contained in Intelligent Diagnostics:

1. Vehicle System and Detected DTC(s)
2. Technical Service Bulletin (OEM Information)
3. DTC Analysis
4. Repair Assist
5. Repair Tips
6. Relevant Cases

NOTE

Before launching the Intelligent Diagnostics function, please ensure the network is connected successfully.

5.1 Accessing Intelligent Diagnostics

5.1.1 Auto Scan

Before launching Intelligent Diagnostics, please ensure that vehicle communication has been established. Connect the MaxiSys diagnostics tablet to the test vehicle through the VCI. For detailed instructions to establish vehicle communication with the MaxiSys tablet, see [Establish Vehicle Communication](#).

Once communication is established, enter the **Diagnostics** application and select a vehicle model. After a vehicle model is selected, tap **Auto Scan** from the Main menu. The System List screen will appear. Tap the **Fault Scan** button at the bottom to scan system faults. For detailed instructions on using the Auto Scan function, see [Auto Scan](#).

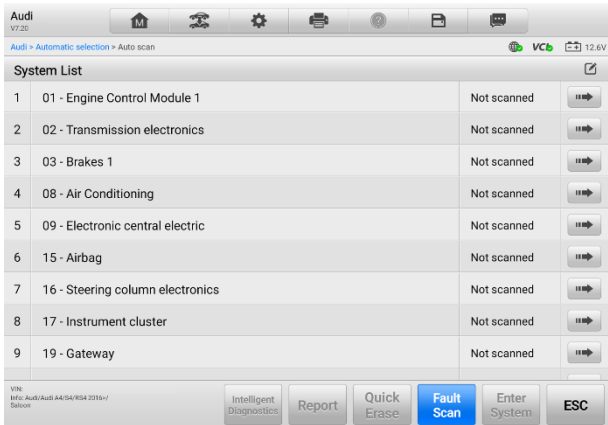

Figure 5-1 System List Screen

Tap the **Fault Scan** button at the bottom. After scanning, a system with identified faults will display in red, with the number of faults displayed on the right. The number of total faults will display on the top.

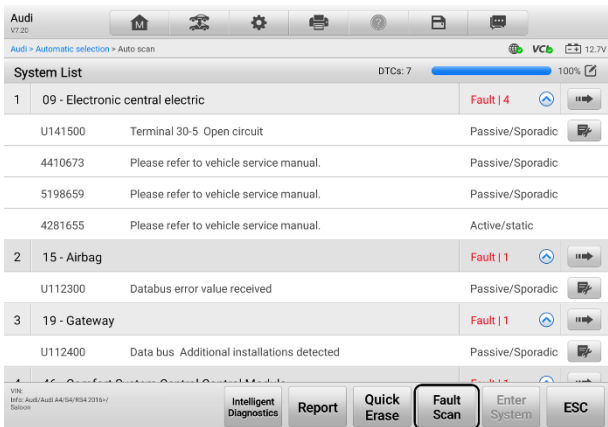





Figure 5-2 Fault Scan Screen

After scanning system faults, there are four methods to access the Intelligent Diagnostics screen:

- ✦ Access via the Intelligent Diagnostics button  to view code-related information of all DTCs for the whole vehicle.

- ❖ Access via the Intelligent Diagnostics icon  to view code-related information of a specific DTC.
- ❖ Access via the Enter System button  to view code-related information of a specific DTC.
- ❖ Access via the Enter System icon  to view code-related information of a specific DTC.

5.1.2 Access via Intelligent Diagnostics Button

After all the faults of the vehicle systems are scanned, tap the **Intelligent Diagnostics** button on the bottom of the screen to directly enter the Intelligent Diagnostics screen. Entering the Intelligent Diagnostics screen, you can find the TSB and DTC analysis information of all DTCs for all the systems that have been scanned.

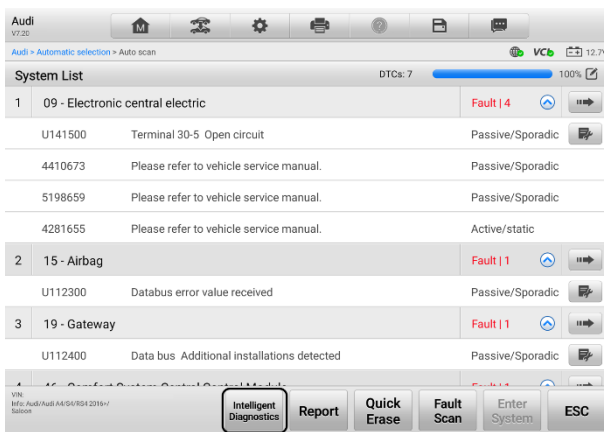



Figure 5-3 Intelligent Diagnostics Button Screen

5.1.3 Access via Intelligent Diagnostics Icon

You can also use the **Intelligent Diagnostics** icon to enter the Intelligent Diagnostics function to get detailed fault repair instructions of a specific DTC.

If the Intelligent Diagnostics function is available for the vehicle, the Intelligent Diagnostics icon will display on the right. The details of the detected faults, including the fault code, fault description and status, will be displayed under the system name or module. Tap the **Intelligent Diagnostics** icon  on the right to directly enter the Intelligent Diagnostics screen.

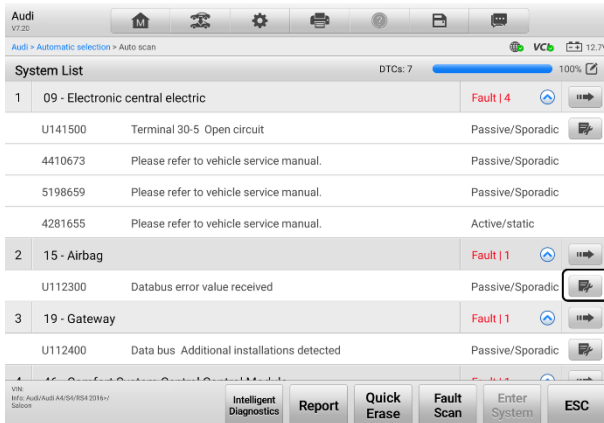

Figure 5-4 Intelligent Diagnostics Icon Screen

5.1.4 Access via Enter System Button

- Select a system from the DTC list to activate the Enter System button at the bottom of the screen. Tap the **Enter System** button.

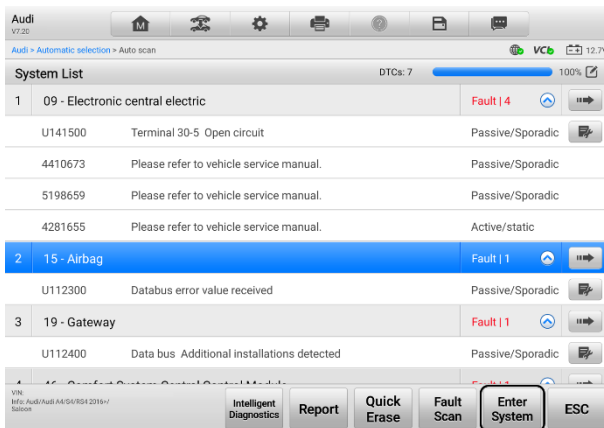

Figure 5-5 Enter System Button Screen

- Select **Trouble Codes** from the function menu screen to enter the trouble codes screen. Available functions vary by vehicle.

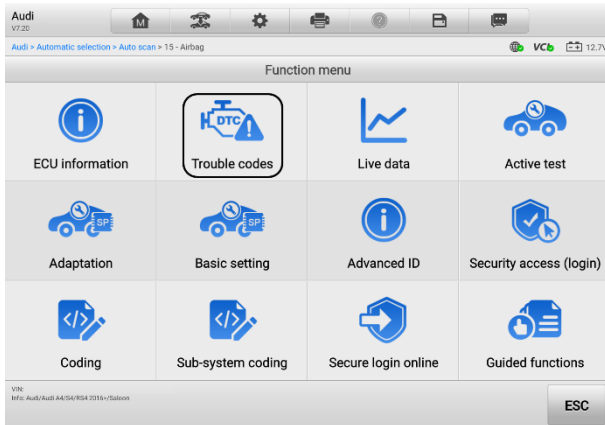



Figure 5-6 Function Menu Screen

- Tap the **Intelligent Diagnostics** icon  to the right of the DTC description, or select a specific DTC from the DTC list, and then tap the **Intelligent Diagnostics** button at the bottom of the screen to enter the Intelligent Diagnostics function.

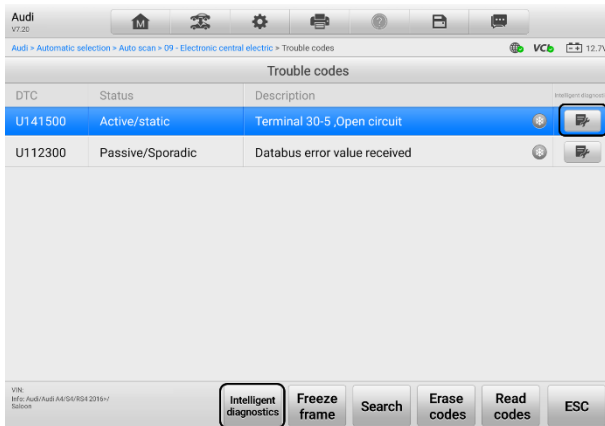



Figure 5-7 Trouble Codes Screen

5.1.5 Access via Enter System Icon

When entering a specific system by tapping the Enter System icon , you can also access the Intelligent Diagnostic screen if the Intelligent Diagnostics function is available for this vehicle.

Tap the **Enter System** icon on the right of a system. Follow the instructions in the [Access via Enter System Button](#) section to continue.

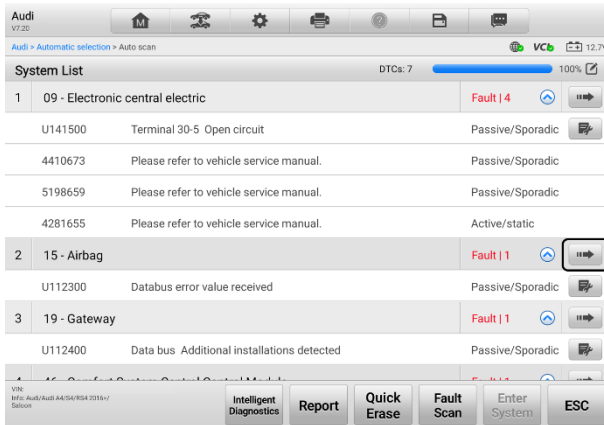

Figure 5-8 Enter System Icon Screen

5.2 Intelligent Diagnostics Operation

Intelligent Diagnostics is an important and powerful function of MaxiSys Elite II Pro. It provides substantial information for intelligent diagnosis of the faults detected, offering Technical Service Bulletin, DTC analysis, Repair Assist, and Repair Tips to help you repair detected faults. It also provides relevant case information for viewing.

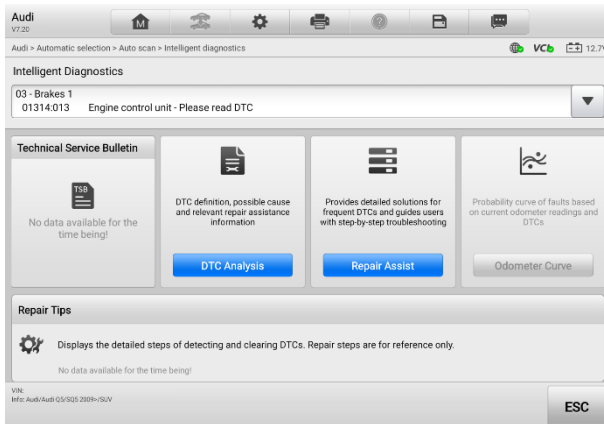

Figure 5-9 Intelligent Diagnostics Layout

The Intelligent Diagnostics function consists of the following sections:

1. **Vehicle System and Detected DTCs** — displays the name of the vehicle system(s) and the detected DTCs.
2. **Technical Service Bulletin** — contains DTC-related recalls, TSB, and OEM campaigns.

3. **DTC Analysis** — provides repair assistance information related to the fault code.
4. **Repair Assist** — intelligently prioritizes DTCs and leads the user to the proper repair.
5. **Repair Tips** — displays the detailed steps of detecting and clearing DTCs. Repair steps are for reference only.
6. **Relevant Cases** — offers relevant fault-clearing cases for reference.

5.2.1 Vehicle System and Detected DTC(s)

This section displays the scanned vehicle systems that contain faults. Tap the drop-down menu to view comprehensive information of all systems or switch to different fault codes for details.

Tap the arrow button on the right to display a drop-down list of all systems along with specific DTCs. Touch and slide up or down on the screen to review all codes in the list. Select all systems or select a DTC to view the corresponding Intelligent Diagnostics information.

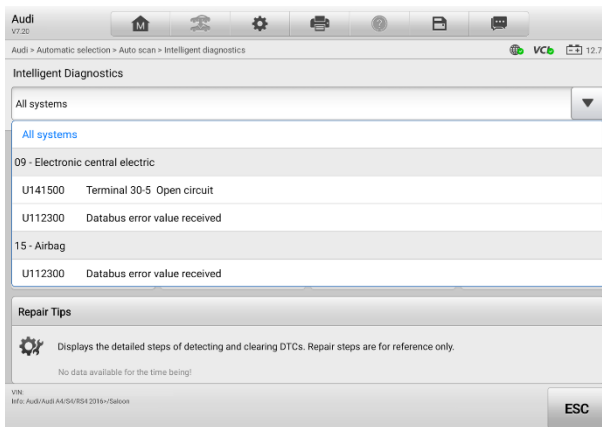

Figure 5-10 Vehicle System and Detected DTC(s) Screen

5.2.2 Technical Service Bulletin (OEM Information)

The Technical Service Bulletin function matches the selected fault code with relevant vehicle manufacturer TSBs. All TSBs related to the selected DTC are listed in the display window. Select one to open the page and view the TSB in details.

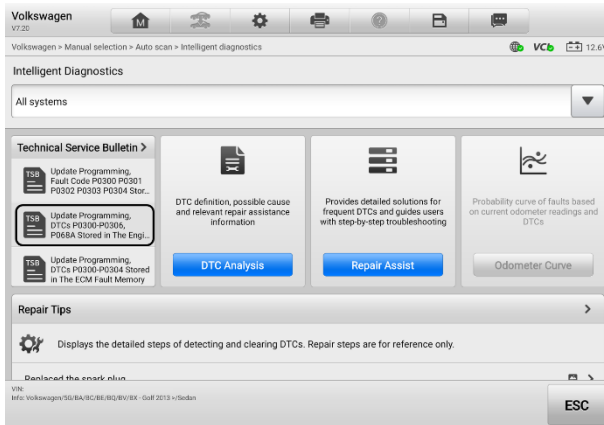

Figure 5-11 Technical Service Bulletin Screen 1

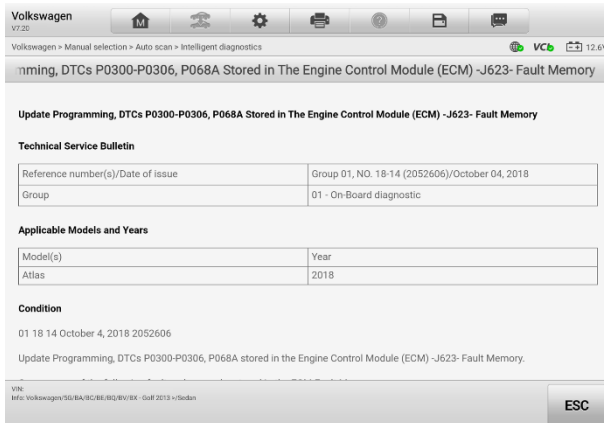

Figure 5-12 Technical Service Bulletin Screen 2

5.2.3 DTC Analysis

On the Intelligent Diagnostics screen, the DTC Analysis contains repair assistance and information related to the fault codes, including the fault description, condition, fault influence, possible causes, and possible solution. The repair assistance information vary by vehicle.

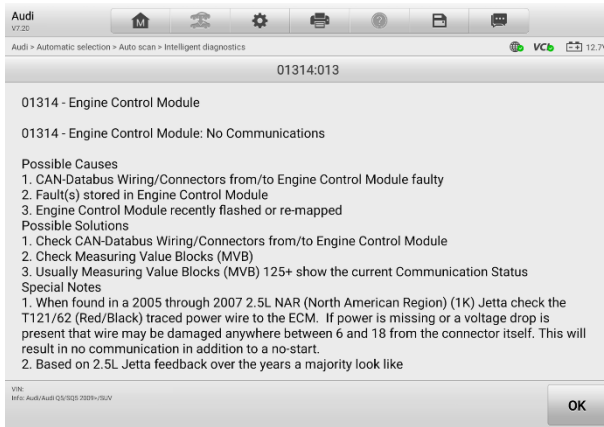

Figure 5-13 DTC Analysis Screen

5.2.4 Repair Assist

The Repair Assist displays a list of items and their descriptions, completion status, and priorities. The higher the priority number is (1 is the highest), the earlier the related items should be tested.

➤ To perform Repair Assist

1. Tap the **Repair Assist** button on the Intelligent Diagnostics screen.

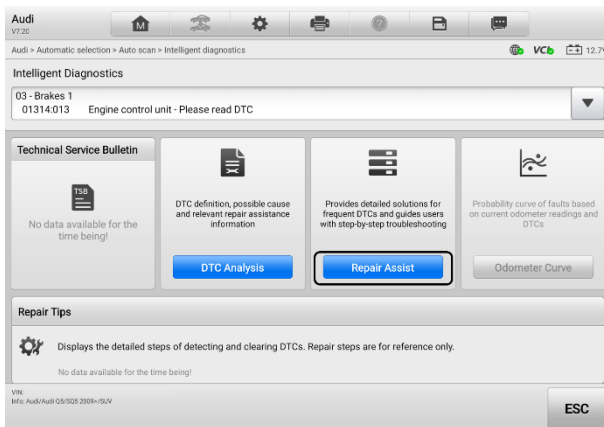



Figure 5-14 Repair Assist Screen 1

2. Tap the **Run** button from the Function Buttons section or tap the  icon on the right of the selected item to perform Repair Assist function.

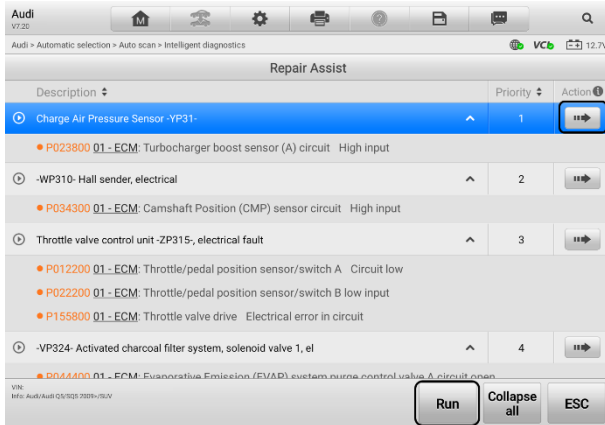

Figure 5-15 Repair Assist Screen 2

3. The fault analysis information such as the repair steps, requires tools, trigger conditions, and system description displays on the screen. Read carefully and tap **Continue** to proceed.

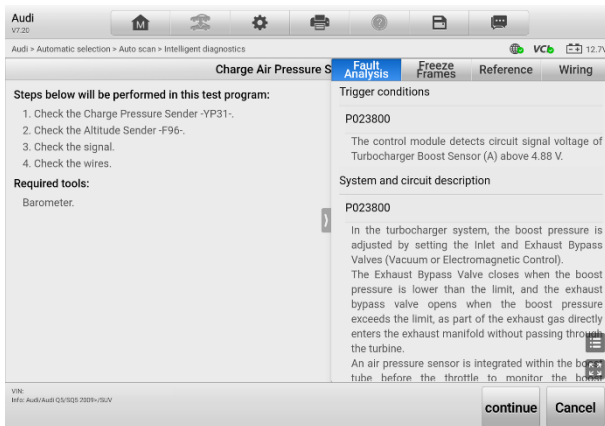



Figure 5-16 Repair Assist Screen 3

NOTE

In some cases, you need to tap this icon  to fold the right column so that the whole interface of Select Branch can be shown.

4. In the repair process, it may integrate one or more diagnostic functions such as Read Codes, Erase Codes, Live Data, Freeze Frame, and Active Test as needed.

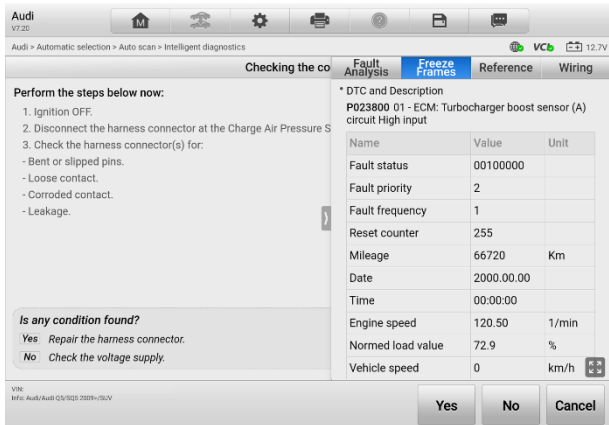

Figure 5-17 Repair Assist Screen 4

5. In some cases, a solution will be generated to guide you to solve the problem with some reference information.

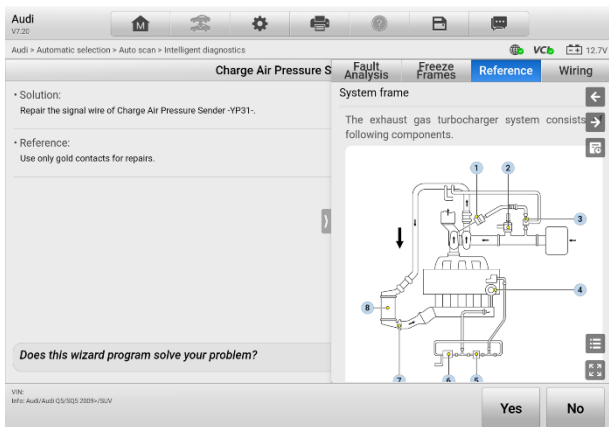



Figure 5-18 Repair Assist Screen 5

6. The related wires can also be located on the *Wiring* screen. Tap the legend button  in the upper-right corner to search or tap a certain module name to locate it. After location, the related wires will be highlighted. Also, you can directly tap a certain module in the diagram to highlight it and the related wires.

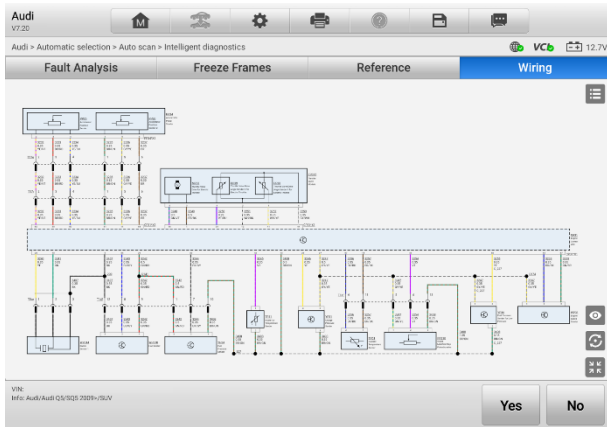











Figure 5-19 Repair Assist Screen 6

Operation instructions of the buttons on the right side of the screen are as follows:

- Tap this button  to search or tap a certain module name to locate it.
- Tap this button  to switch to the last one or tap this button  to switch to the next one.
- Tap this button  to find what you have previously viewed.
- Tap this button  to hide the unrelated wires, and tap this button  to show the hidden wires.
- Tap this button  to restore the initial settings.
- Tap this button  to exit the full screen, and tap this button  to enter the full screen.

5.2.5 Repair Tips

The Repair Tips function displays a range of diagnostic and repair steps, including the information needed in order to clear the faults. Repair steps are for reference only.

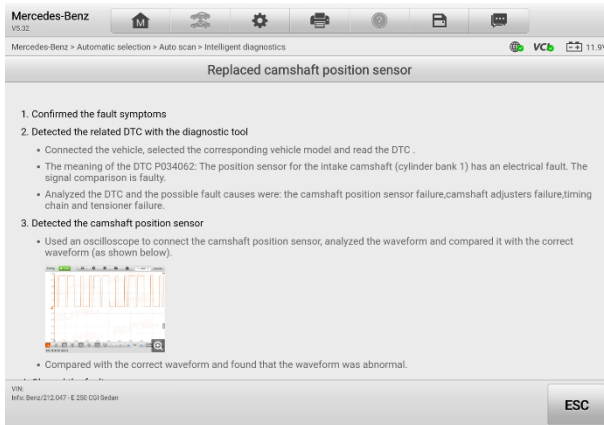

Figure 5-20 Repair Tips Description

5.2.6 Relevant Cases

This section offers recommended repair cases that may be relevant to the current vehicle and/or the current fault. These repair cases may provide greater insight into diagnosing and repairing your vehicle. Tap the relevant cases to review.



Figure 5-21 Relevant Case Screen

➤ To review relevant cases information

1. Tap the **Relevant Cases** icon to display main page.
2. Scroll through the page and to locate relevant information.
3. Tap the arrow icon at the left top and return to the previous repair case page.

6 Service

The **Service** section is specially designed to provide quick access to the vehicle systems for various scheduled service and maintenance tasks. The typical service operation screen is a series of menu-driven commands. Follow the on-screen instructions to select appropriate options, enter values or data, and perform necessary actions. The application will display detailed instructions to complete selected service operations.

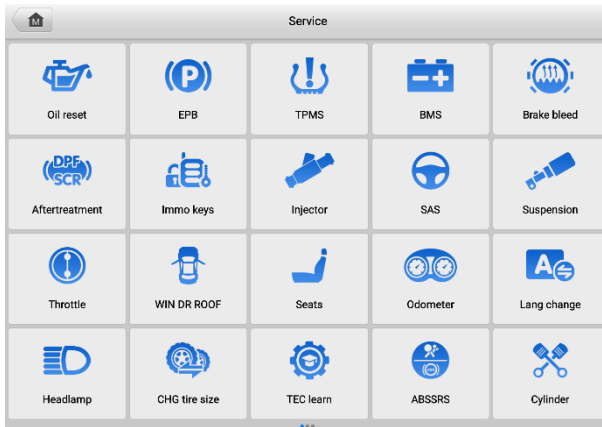

Figure 6-1 Service Menu

Several most commonly used services are described in this chapter.

6.1 Oil Reset Service

Perform reset for the Engine Oil Life system, which calculates an optimal oil life change interval depending on the vehicle driving conditions and climate. The Oil Life Reminder must be reset each time the oil is changed so that the system can calculate when the next oil change is required.

NOTE

1. Always reset the engine oil life to 100% after every oil change.
2. All required work must be carried out before the service indicators are reset. Failure to do so may result in incorrect service values and cause DTCs to be stored by the relevant control module.
3. For some vehicles, the scan tool can reset additional service lights such as maintenance cycle and service interval. On BMW vehicles, for example, service resets include engine oil, spark plugs, front/rear brakes, coolant, particle filter, brake fluid, micro filter, vehicle inspection, exhaust emission inspection and vehicle checks.

6.2 Electric Parking Brake (EPB) Service

This function has a multitude of usages to maintain the electronic braking system safely and effectively. The applications include deactivating and activating the brake control system, assisting with brake fluid control, opening and closing brake pads, and setting brakes after disc or pad replacement.

6.2.1 EPB Safety

It can be dangerous to perform Electric Parking Brake (EPB) system maintenance, so before you begin the service work, please keep these rules in mind.

- ✓ Ensure that you are fully familiar with the braking system and its operation before commencing any work.
- ✓ The EPB control system may be required to be deactivated before carrying out any maintenance/diagnostic work on the brake system. This can be done from the tool menu.
- ✓ Only perform maintenance work when the vehicle is stationary and on level ground.
- ✓ Ensure that the EPB control system is reactivated after the maintenance work has been completed.

NOTE

Autel accepts no responsibility for any accident or injury arising from the maintenance of the Electric Parking Brake system.

6.3 Tire Pressure Monitoring System (TPMS) Service

This function allows you to quickly look up the tire sensor IDs from the vehicle ECU, as well as to perform TPMS replacement and reset procedures after tire sensors are replaced.

6.4 Battery Management System (BMS) Service

The Battery Management System (BMS) allows the tool to evaluate the battery charge state, monitor the close-circuit current, register the battery replacement, activate the rest state of the vehicle, and charge the battery via the diagnostic socket.

NOTE

- This function is not supported by all vehicles.
 - The sub functions and actual test screens of the BMS may vary by vehicle, please follow the on-screen instructions to make correct option selection system.
-

The vehicle may use either a sealed lead-acid battery or an Absorbed Glass Mat (AGM) battery. Lead acid battery contains liquid sulphuric acid and can spill when overturned. AGM battery (known as VRLA battery, valve regulated lead acid) also contains sulphuric acid, but the acid is contained in glass mats between terminal plates.

It is recommended that the replacement aftermarket battery has the same specifications, such as capacity and type, as the exiting battery. If the original battery is replaced with a different type of battery (e.g. a lead-acid battery is replaced with an AGM battery) or a battery with a different capacity (mAh), the vehicle may require reprogramming of the new battery type, in addition to, performing the battery reset. Consult the vehicle manual for additional vehicle-specific information.

6.5 Diesel Particle Filter (DPF) Service

The Diesel Particle Filter (DPF) function manages DPF regeneration, DPF component replacement teach-in and DPF teach-in after replacing the engine control unit.

The ECM monitors driving style and selects a suitable time to employ regeneration. Cars driven a lot at idling speed and low load will attempt to regenerate earlier than cars often driven with higher load and speed. For regeneration to take place, a prolonged high exhaust temperature must be obtained.

In the event of the car being driven in such a way that regeneration is not possible (i.e., frequent short journeys), a diagnostic trouble code will eventually be registered in addition to the DPF light and “Check Engine” indicators displaying. A service regeneration can be requested in the workshop using the diagnostics tool.

Before performing a forced DPF regeneration using the tool, check the following items:

- The fuel light is not on.
- No DPF-relevant faults are stored in system.
- The vehicle has the specified engine oil.
- The oil for diesel is not contaminated.

! IMPORTANT

Before diagnosing the problem vehicle and attempting to perform an emergency regeneration, it is important to obtain a full diagnostic log and read out relevant measured value blocks.

🔧 NOTE

1. The DPF will not regenerate if the engine management light is on, or there is a faulty EGR valve.
2. The ECU must be re-adapted when replacing the DPF and when topping up the fuel additive Eolys.

3. If the vehicle needs to be driven in order to perform a DPF service, a second person is required for the function. One person should drive the vehicle while the other person observes the screen on the tool. Do not attempt to drive and observe the scan tool at the same time. This is dangerous and puts your life and the lives of other motorists and pedestrians at risk.
-

6.6 Immobilizer (IMMO) Service

An immobilizer is an anti-theft mechanism that prevents an automobile's engine from starting unless the correct ignition key or other device is present. This device prevents thieves from starting the car by a method known as hot wiring. Most new vehicles have an immobilizer as standard equipment. An important advantage of this system is that it doesn't require the car owner to activate it; it operates automatically. An immobilizer is considered as providing much more effective anti-theft protection than an audible alarm alone; many auto insurance companies offer lower rates for vehicles that are equipped with an immobilizer.

As an anti-theft device, an immobilizer disables one of the systems needed to start a car's engine, usually the fuel supply or the ignition. This is accomplished by radio frequency identification between a transponder in the ignition key and a device called a radio frequency reader in the steering column. When the key is placed in the ignition, the transponder sends a signal with a unique identification code to the reader, which relays it to a receiver in the vehicle computer control module. If the code is correct, the computer allows the fuel supply and ignition systems to operate and start the car. If the code is incorrect or absent, the computer disables the system, and the car will be unable to start until the correct key is placed in the ignition.

The IMMO service can disable a lost vehicle key and program the replacement key fob. One or more replacement key fobs can be programmed.

6.7 Steering Angle Sensor (SAS) Service

SAS Calibration permanently stores the current steering wheel position as the straight-ahead position in the SAS EEPROM. Therefore, the front wheels and the steering wheel must be set exactly to the straight-ahead position before calibration. In addition, the VIN is also read from the instrument cluster and stored permanently in the SAS EEPROM. On successful completion of calibration, the SAS fault memory is automatically cleared.

Calibration must always be carried out after the following operations:

- Steering wheel replacement
- SAS replacement
- Any maintenance that involves opening the connector hub from the SAS to the column

- Any maintenance or repair work on the steering linkage, steering gear or other related mechanism
 - Wheel alignment or wheel track adjustment
 - Accident repairs where damage to the SAS or assembly, or any part of the steering system may have occurred
-

 **NOTE**

- Autel accepts no responsibility for any accident or injury arising from servicing the SAS system. When interpreting DTCs retrieved from the vehicle, always follow the manufacturer's recommendation for repair.
 - All software screens shown in this manual are examples, and actual test screens may vary by test vehicle. Pay attention to the menu titles and onscreen instructions to make correct option selections.
 - Before starting procedure, make sure the vehicle has an ESC button. Look for button on dash.
-

7 Battery Test

Battery Test conducts battery and cranking/charging systems analysis and enables technicians to view the health status of the vehicle's battery and electrical system. Functions include in-vehicle test and out-vehicle test.

NOTE

The MaxiBAS BT506 tester is sold separately.

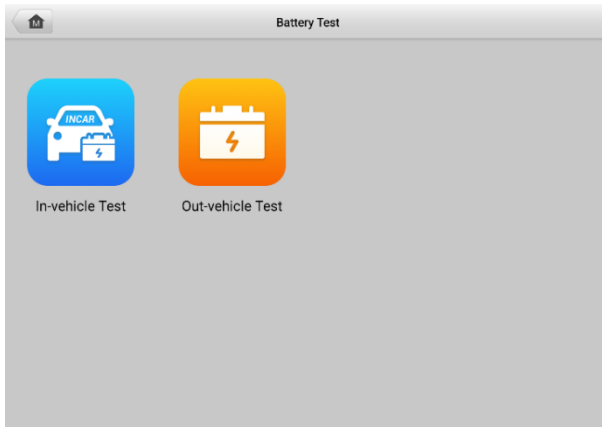

Figure 7-1 Battery Test Screen

7.1 Test Preparation

7.1.1 Inspect the Battery

Before starting a test, observe the battery for:

- Cracking, buckling or leaking (If you see any of these defects, replace the battery.)
- Corroded, loose or damaged cables and connections (Repair or replace as needed.)
- Corrosion on the battery terminals, and dirt or acid on the case top (Clean the case and terminals using a wire brush and a mixture of water and baking soda.)

7.1.2 Connect the Battery Tester

➤ **To pair the BT506 battery tester with the MaxiSys Elite II Pro tablet**

1. Press and hold the **Power/Lock** button to turn on the tablet and battery tester. Ensure that each unit is sufficiently charged before use.

2. Enable **Bluetooth** on the MaxiSys Elite II Pro by tapping **VCI Manager > BAS BT**, and the tablet automatically scans for an available tester for pairing. The device name will appear as “Maxi” suffixed with a serial number.
3. Check the serial number of your battery tester and select the desired device for pairing.
4. When paired successfully, the connection status will read as “Connected.”

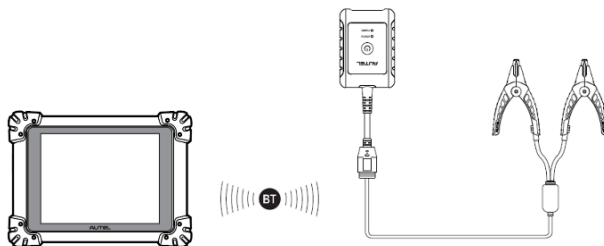

➤ **To connect to a battery**

Connect the red clamp to the positive (+) terminal and the black clamp to the negative (-) terminal of the battery.

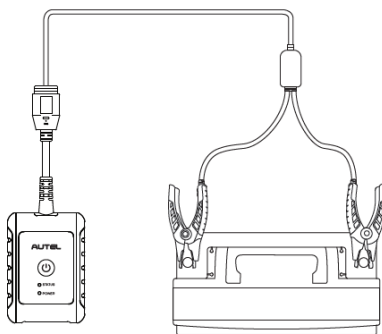

7.2 In-vehicle Test

In-vehicle Test is used for testing batteries that are installed in a vehicle. An in-vehicle test includes Battery Test, Starter Test, and Generator Test. These tests help determine the health status of the battery, the starter, and the generator.

! **IMPORTANT**

A disclaimer page will appear when accessing any function on the Home screen for the first time. Please read the end user agreement and tap **Accept** to continue. If you tap **Decline**, you will not be able to use the features properly.

Prior to testing any battery, ensure that the battery tester is paired with the tablet via Bluetooth and is connected properly to a battery.

7.2.1 Start the test

➤ To start the battery test

1. Tap the **Battery Test** application on the MaxiSys Job Menu. Select **In-vehicle Test**.
2. Confirm your vehicle information and make sure the VIN information is filled.
3. Confirm your battery information, including voltage, type, standard, and capacity. Tap **Next** to continue in-vehicle test functions.

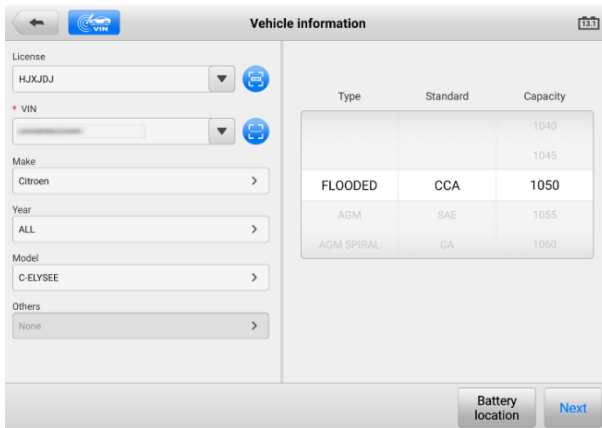



Figure 7-2 Battery Information Screen

Please refer to the table below for a list of buttons that may appear when accessing the functions:

Table 7-1 Top Toolbar Buttons

Button	Name	Description
	Battery Connection	The value on the icon indicates the real-time voltage of the tested battery. In the battery test, the button will turn green if the battery is good; otherwise, it will turn red.
	Home	Returns to the MaxiSys Job Menu.
	Next	Tap to proceed.

Button	Name	Description
	Back	Returns to the previous screen.
	Exit	Returns to the Job Menu.

7.2.2 Battery Test

1. Follow the on-screen instructions. Check the boxes once all required tasks are completed and tap **Start Testing**.

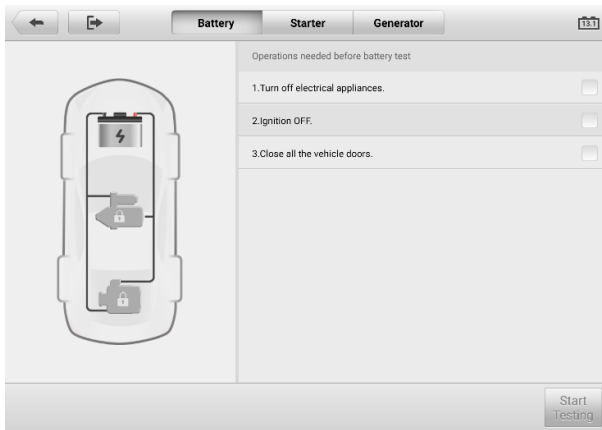

Figure 7-3 Battery Test Screen

2. Wait until the test is completed. The test results will be displayed on the tool.

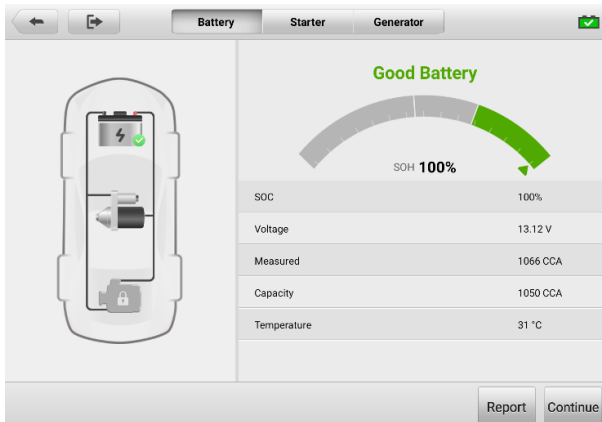

Figure 7-4 Battery Test Results Screen

Battery Test Results

The battery test results include a color-coded results summary, a list of test data, and repair tips.

Table 7-2 Battery Test Results

Result	Repair Tip
Good Battery	Battery is good.
Good & Recharge	Battery is good but insufficiently charged. Recharge the battery.
Charge & Retest	Battery requires charge to determine its condition.
Bad Cell	Replace the battery.
Replace Battery	Replace the battery.

NOTE

Please always complete the battery test before you proceed to the starter and generator tests.

7.2.3 Starter Test

Follow the on-screen instructions to complete the test. Start the engine and let it idle. The test results will appear as follows:

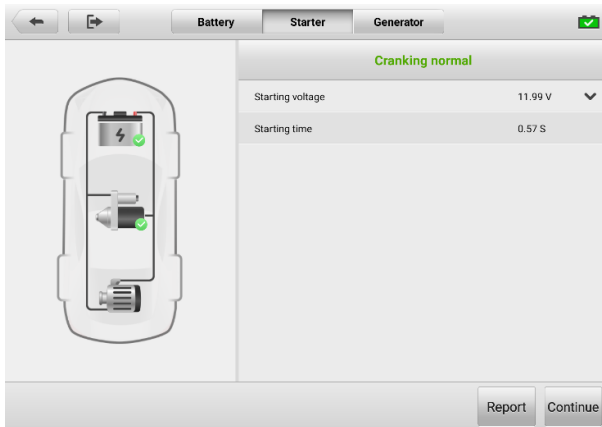

Figure 7-5 Starter Test Results Screen

Table 7-3 Starter Test Results

Result	Description
Cranking Normal	The starter is good.
Current Too Low	Low momentary discharge capacity.
Voltage Too Low	Low battery storage capacity.
Not Started	The starter is not detected for starting.

7.2.4 Generator Test

Follow the on-screen instructions to complete the test. The test results will appear as follows:

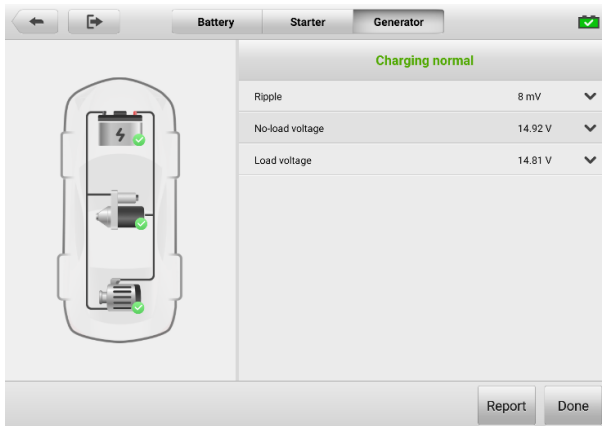

Figure 7-6 Generator Test Results Screen

Table 7-4 Generator Test Results

Result	Description
Charging Normal	The generator is functioning normally.
Output Too Low	<ul style="list-style-type: none"> ● The belt linking the starter and the generator is loose. ● The cable linking the starter and battery is loose or corroded.
Output Too High	<ul style="list-style-type: none"> ● The generator is not properly connected to the ground. ● The voltage adjuster is broken and needs replacement.
Ripple Too Large	The commutation diode is broken.

Result	Description
No Output	<ul style="list-style-type: none"> ● The cable is loose. ● Some vehicles with power management systems do not provide path for charging due to the sufficient load capacity of the battery. ● The generator or the voltage adjuster is broken and needs replacement.

7.3 Out-vehicle Test

Out-vehicle Test is used to test the conditions of batteries that are not connected to a vehicle. This function aims to check the health status of the battery only.

7.3.1 Test Procedure

➤ **To start the out-vehicle test**

1. Tap the **Battery Test** application on the MaxiSys Job Menu. Select **Out-vehicle Test**.
2. Connect the tester clamps to the battery terminals.
3. Select the appropriate battery type, rating standard, and CCA value. Tap **Start Testing** to start the test.

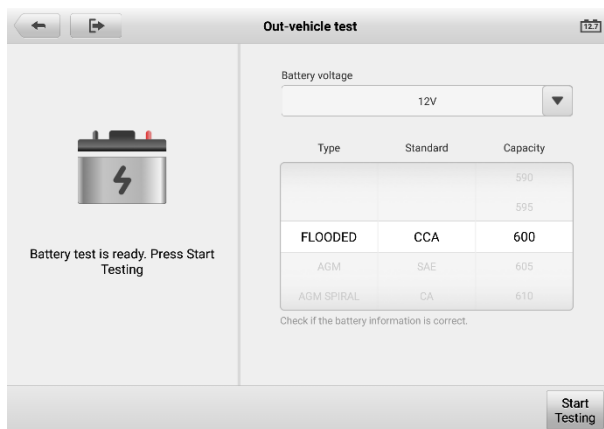

Figure 7-7 Out-vehicle Test Screen

4. The test results will display in a few seconds.

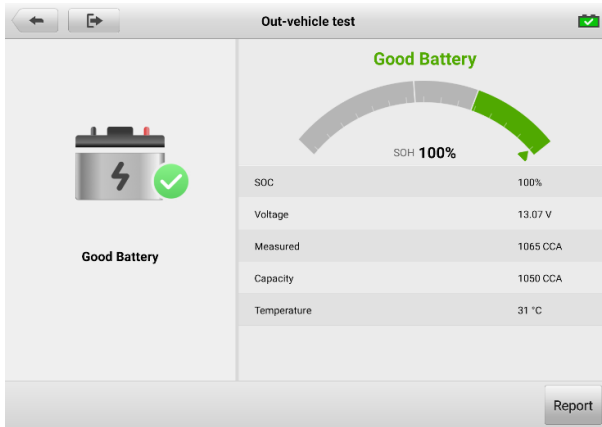

Figure 7-8 Out-vehicle Test Results Screen

7.3.2 Test Results

Icons are color-coded to indicate status.

Table 7-5 Out-vehicle Test Results

Result	Description
Good Battery	Battery meets required standards.
Good & Recharge	Battery is good, but low on charge. Fully charge the battery. Check for causes of low charge.
Charge & Retest	Battery requires charge to determine its condition.
Replace Battery	Battery fails to meet industry-accepted standards.
Bad Cell	Battery fails to meet industry-accepted standards.

8 OEM Authorization

The OEM Authorization application allows to unlock the gateway ECU (CGW) for some vehicles to perform advanced diagnostics tests.

NOTE

Make sure the tablet is connected to the Internet before launching the OEM Authorization application.

➤ To unlock the gateway ECU (CGW)

1. Connect the MaxiSys tablet to the vehicle through the VCI. See [Establish Vehicle Communication](#) for details.
2. Tap **Diagnostics** on the MaxiSys Job Menu.
3. Tap **Renault**, select the vehicle type and tap **OK** to confirm the vehicle information.
4. On the Information screen, tap **Unlock**.



Figure 8-1 Information Screen

5. On the Purchase screen, tap **OK**. Select purchase method and pay to unlock the gateway. On the Purchase Successful screen, tap **OK**.

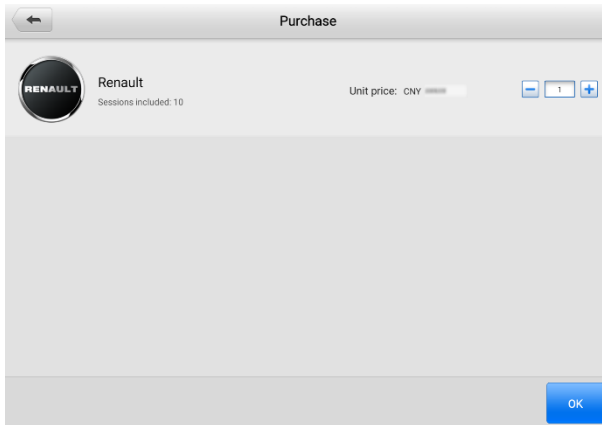

Figure 8-2 Purchase Screen

- Exit the application. Tap **OEM Authorization** on the MaxiSys Job Menu. On the OEM Authorization screen, tap **Renew**. The Unlocking Information screen appears, on which you can view the remaining service sessions.

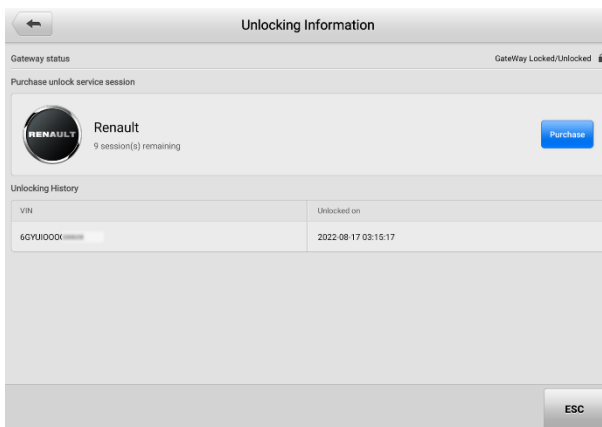

Figure 8-3 Unlocking Information Screen

9 Settings

Access the Settings menu to adjust default settings and view information about the MaxiSys system.

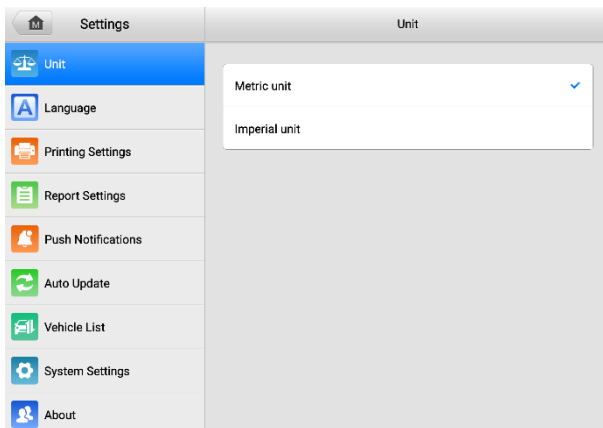

Figure 9-1 Settings Screen

The following options are available for the MaxiSys system settings:

- Unit
- Language
- Printing Settings
- Report Settings
- Push Notifications
- Auto Update
- Vehicle List
- System Settings
- About

This section describes the operation procedures for the settings.

9.1 Unit

This option allows you to change the measurement unit for the diagnostics system.

➤ **To change the unit setting**

1. Tap the **Settings** application on the MaxiSys Job Menu.

2. Tap the **Unit** option on the left column.
3. Select the appropriate measurement unit. A check mark displays to the right of the selected unit.
4. Tap the **Home** button on the top-left corner to return to the MaxiSys Job Menu. Or select another settings option for the system setup.

9.2 Language

This option allows you to change the display language for the MaxiSys system.

➤ To adjust the language setting

1. Tap the **Settings** application on the MaxiSys Job Menu.
2. Tap the **Language** option on the left column.
3. Select the appropriate language. A check mark displays to the right of the selected language.
4. Tap the **Home** button on the top left corner to return to the MaxiSys Job Menu. Or select another settings option for the system setup.

9.3 Printing Settings

9.3.1 Printing Settings

This option allows you to print from the tablet to a network printer via a computer.

➤ To set up the printer connection

1. Tap **Settings** on the MaxiSys Job Menu.
2. Tap **Printing Settings** on the left column.
3. Select **Print via PC-Link** or **Print via Wi-Fi**. A check mark will display to the right of the selected item.
4. Tap **Home** on the top-left corner to return to the MaxiSys Job Menu. Or select another settings option for the system setup.

9.3.2 Printing Operations

➤ To install the MaxiSys Printer driver program

1. Download **Maxi PC Suite** from www.autel.com > *Support* > *Downloads* > *Autel Update Tools*, and install to your Windows-based PC.
2. Double-click on **Setup.exe**.
3. Select an installation language and the wizard will load.
4. Follow the instructions on the screen and click **Next** to continue.

5. Click **Install** and the printer driver program will be installed to the computer.
6. Click **Finish** to complete the installation.

This section describes how to receive files from the MaxiSys tablet and perform printing through the computer.

NOTE

Make sure the computer installed with the MaxiSys Printer driver program is connected to a printer.

➤ **To perform printing through a computer**

1. Make sure the tablet is connected to the computer network, via Wi-Fi or LAN, before printing.
2. Run the **PC Link** program on the computer.
3. Click **Test Print** to check whether the printer works properly.
4. Tap the **Print** button on the toolbar of the tablet. A test document will be sent to the computer.
 - If the **Auto Print** option in the MaxiSys Printer is selected, the MaxiSys printer will automatically print the received document.
 - If the **Auto Print** option in the MaxiSys Printer is not selected, click the **Open PDF File** button to view files. Select the file(s) to be printed and click **Print**.

9.4 Report Settings

This option automatically synchronizes the diagnostics information of the vehicle to the vehicle history and forms a diagnostics report for the user to upload. Tap the **ON/OFF** button to enable/disable the Report Upload to Cloud function. The button appears blue if the function is enabled and gray if the function is disabled.

9.5 Push Notifications

This option allows you to manage notifications. The Notification Preference is turned on by default and cannot be turned off by users so that certain system notifications such as system security warning will not be blocked. Internet access is required for receiving online messages.

➤ **To manage other notifications**

1. Tap **Settings** on the MaxiSys Job Menu.
2. Tap **Push Notifications** on the left column.
3. Tap the  button on the right to open a drop-down list.
4. There are four options: Enable all notifications, Limit to 3 notifications or less per week, Limit to 1 notification per week, and Disable all notifications. Select

whichever you want.

5. Tap **Home** on the top-left corner to return to the MaxiSys Job Menu. Or select another settings option for the system setup.

When the Push Notifications function is performed and new messages are received by the MaxiSys device, a notification message displays on the MaxiSys Job Menu. Press on the message bar and drag it down to display a list of received messages. Slide the list up or down to view additional messages if present.

Tap a specific message to launch the corresponding application. For example, if you tap on an Update notification message, the Update application will be launched.

9.6 Auto Update

This option allows you to preset a time to update the software. There are three update options: OS Update, MaxiSys Update, and Vehicle Update.

Tap **ON/OFF** to enable/disable the Auto Update function. The button displays blue if the Auto Update is enabled and displays gray if the Auto Update is disabled. Set the time of the day for updating. If a specific time is set, the selected software will be automatically updated at this specific time.

9.7 Vehicle List

This option allows you to sort the vehicles either by alphabetical order or by frequency of use.

➤ To adjust the vehicle list setting

1. Tap the **Settings** application on the MaxiSys Job Menu.
2. Select **Vehicle List** on the left column.
3. Select the required sort type. A check mark will display to the right of the selected item.
4. Tap the **Home** button on the top-left corner to return to the MaxiSys Job Menu. Or select another settings option for system setup.

9.8 System Settings

This function provides you with direct access to the Android system settings interface, where you can adjust various system settings for the Android system platform, regarding wireless and networks settings, various device settings such as sound and display, as well as system security settings, and check related information about the Android system. Refer to Android documentation for additional information.

9.9 About

The About function provides information of the MaxiSys diagnostics device, including the product name, version, hardware, and serial number.

➤ **To check the MaxiSys product information in About**

1. Tap the **Settings** application on the MaxiSys Job Menu.
2. Select the **About** option on the left column. The product information screen displays on the right.
3. Tap the **Home** button on the top-left corner to return to the MaxiSys Job Menu. Or select another settings option for the system setup after viewing.

10 Data Manager

The Data Manager application allows you to store, print, and review the saved files, manage the workshop information, customer information records, and keep test vehicle records.

Selecting the **Data Manager** application opens the file system menu. There are nine main functions available.





Figure 10-1 Data Manager Screen

The table below describes each of the function buttons in the Data Manager application.

Table 10-1 Buttons in Data Manager

Name	Button	Description
Vehicle History		Tap to view the diagnostics records.
Workshop Information		Tap to view or edit the workshop information.
Customer		Tap to create a new customer account file.
Image		Tap to view the screenshots.
Cloud Report		Tap to review the saved reports and share cloud reports.
PDF		Tap to view the reports stored as PDF files.

Name	Button	Description
Review Data		Tap to view the recorded data.
Data Logging		Tap to view communications with Autel support service and ECU information of the test vehicle. The saved data can be reported and sent to the technical center via the Internet.
Uninstall Apps		Tap to uninstall applications.

10.1 Vehicle History

This function stores records of test vehicle, including vehicle information and the retrieved DTCs from previous diagnostic sessions. Test information is summarized and displays in an easy-to-read table listing. The Vehicle History also provides direct access to the previously tested vehicle and allows you to directly restart a diagnostic session without needing to perform auto or manual vehicle selection.

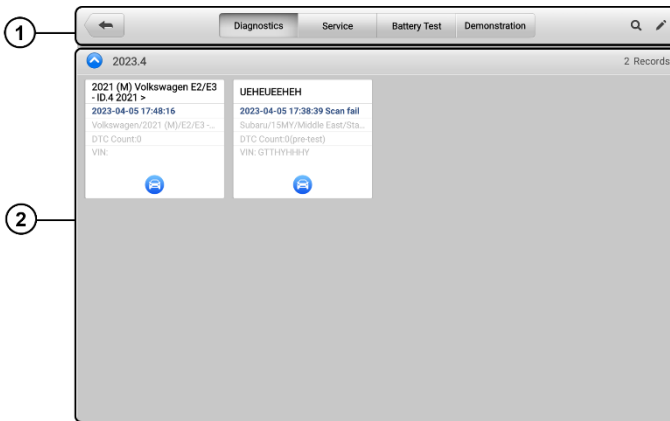

Figure 10-2 Vehicle History Screen

1. Top Toolbar Buttons — navigation and application controls.
 2. Main Section — displays all the vehicle records.
- **To activate a test session for the recorded vehicle**
1. Tap **Data Manager** on the MaxiSys Job Menu.
 2. Select **Vehicle History** to open the screen. Tap **Diagnostics, Battery Test or Service** to select test records.
 3. Tap the icon at the bottom of the thumbnail of a vehicle record.

4. The Diagnostics screen of the vehicle appears and a new diagnostics session is activated. Or select a vehicle thumbnail to select a record. A Test Records window appears. Review the recorded information of the test vehicle and tap the button on the upper-right corner to continue diagnostics.

10.1.1 Test Records

A Test Record is a detailed data form of the tested vehicle, which includes general vehicle information, service record, customer information, and the diagnostic trouble codes retrieved from previous test sessions. Technician Notes will also display if present.

NOTE

The MaxiSys tablet must establish a connection to the VCI to restart test sessions on a previously tested vehicles.

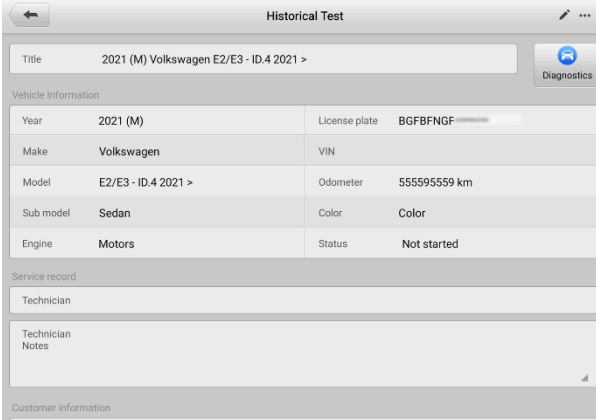

Historical Test			
Title		2021 (M) Volkswagen E2/E3 - ID.4 2021 >	
Vehicle Information			
Year	2021 (M)	License plate	BGFBFNGF
Make	Volkswagen	VIN	
Model	E2/E3 - ID.4 2021 >	Odometer	555595559 km
Sub model	Sedan	Color	Color
Engine	Motors	Status	Not started
Service record			
Technician			
Technician Notes			
Customer information			

Figure 10-3 Test Records Sheet

➤ To edit the Test Records

1. Tap **Data Manager** on the MaxiSys main screen.
2. Select **Vehicle History**.
3. Select a specific vehicle history record thumbnail from the main section. The historical test sheet will appear.
4. Tap the **Edit** button (a pen icon) to start editing.
5. Tap each item to enter information or attach files or images.
6. Tap **Add a Customer** to correlate the historical test sheet to an existing customer account, or add a new account to be correlated with the test vehicle record. See [Customer](#) for more information.
7. Tap **Done** to save the updated record or tap **Cancel** to exit without saving.

NOTE

The vehicle VIN, license number, and customer account are correlated by default. Vehicle records will automatically be correlated using this vehicle and customer identification.

10.2 Workshop Information

The Workshop Information allows you to enter, edit, and save detailed workshop information, such as shop name, address, phone number, and other remarks, which, when printing vehicle diagnostics reports and other correlated test files, will appear as the header of your printed documents.

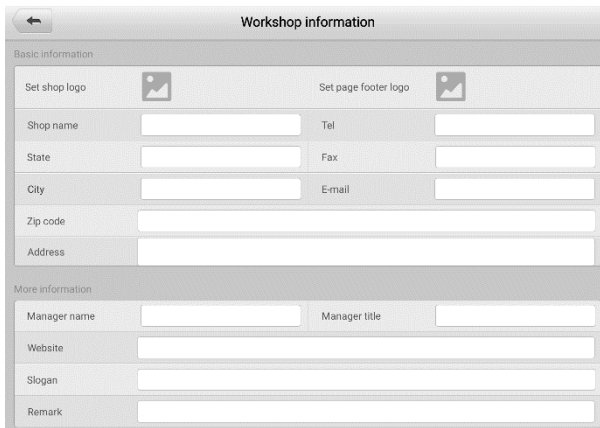

Figure 10-4 Workshop Information Sheet

➤ To edit the Workshop Information sheet

1. Tap **Data Manager** on the MaxiSys Main Screen.
2. Select **Workshop Information**.
3. Tap on each field to enter the corresponding information.
4. Tap **Done** to save the updated workshop information or tap **Cancel** to exit without saving.

10.3 Customer

The Customer function allows you to create and edit customer accounts. It helps you to save and organize all customer accounts that are correlated with the test vehicle records.

➤ To create a customer account

1. Tap the **Data Manager** application on the MaxiSys main screen.
2. Select **Customer**.

3. Tap the **Add a Customer** button. An empty information form appears. Tap each field to enter the appropriate information.

 **NOTE**

Required fields are denoted by an asterisk.

4. For customers with more than one vehicle for service, tap **Add New Vehicle Information**. To delete the added vehicle information, tap the  button.
5. Tap **Complete** on the upper-right corner of the screen to save the customer information or tap **Cancel** to exit without saving.

➤ **To edit a customer account**

1. Tap **Data Manager** on the MaxiSys Job Menu.
2. Select **Customer**.
3. Select a customer account by tapping the corresponding name card. A Customer Information record appears.
4. Tap **Edit** on the top toolbar to start editing.
5. Tap on the input field to edit the information.
6. Tap **Complete** to save the updated information or tap **Cancel** to exit without saving.

➤ **To delete a customer account**

1. Tap **Data Manager** on the MaxiSys Job Menu.
2. Select **Customer**.
3. Select a customer account by tapping the corresponding name card. A Customer Information record appears.
4. Tap **Edit** on the top toolbar to start editing.
5. Tap **Delete** on the top of the screen. A reminder message appears.
6. Tap **OK** to confirm the command and delete the account. Tap **Cancel** to cancel the request.

10.4 Image

The Image section is a PNG database containing all captured screenshots.

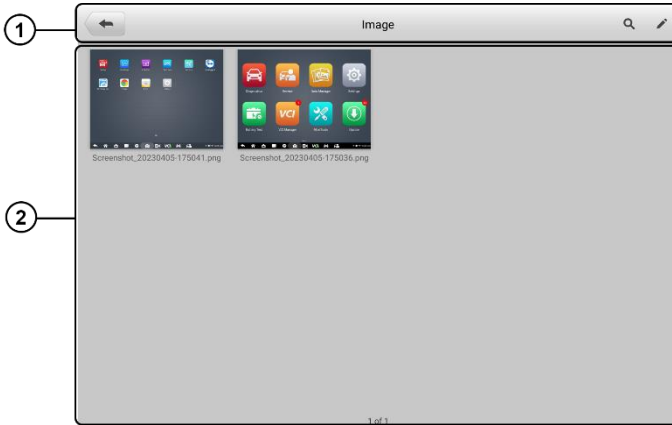



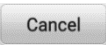





Figure 10-5 Image Database Screen

1. **Toolbar Buttons** — used to edit, print or delete the image files. See [Table 10-2 Toolbar Buttons Description](#) below for detailed information.
2. **Main Section** — displays the stored images.

Table 10-2 Toolbar Buttons Description

Name	Button	Description
Back		Return to the previous screen.
Search		Tap to enter the search page.
Edit		Tap to display the editing toolbar to print, delete or view image.
Cancel		Tap to close the editing toolbar or cancel file search.
Search		Quickly searches the image by entering the time of the screenshot.
Print		Tap to print the selected image.
Delete		Tap to delete the selected image.
Email		Tap to attach the selected image to an email.

➤ **To edit/delete image(s)**

1. Select **Data Manager** on the MaxiSys Job Menu.
2. Select **Image** to access the PNG database.
3. Tap **Edit** on the top-right corner of the window. The editing screen appears.

4. Select the image(s) you want to edit by tapping the check box at the bottom-right corner of the image.
5. Tap **Delete** to delete the selected images or delete all images. Tap the **Print** icon to print the selected image(s). Tap **Email** to attach the selected image(s) to an email.

10.5 Cloud Report

The Cloud Report section stores diagnostics reports. You can view local reports or share the report to the Autel cloud after entering the report database and selecting a specific report.

10.6 PDF Files

The PDF section stores and displays all PDF files of the saved data. After entering the PDF database, select a PDF file to view the stored information.

This section uses the standard Adobe Acrobat Reader application for file viewing and editing. Please refer to the associated Adobe Acrobat Reader manual for more detailed instructions.

10.7 Review Data

The Review Data function allows you to play back the recorded data frames from live data streams.

On the Review Data main screen, select a record to play back.

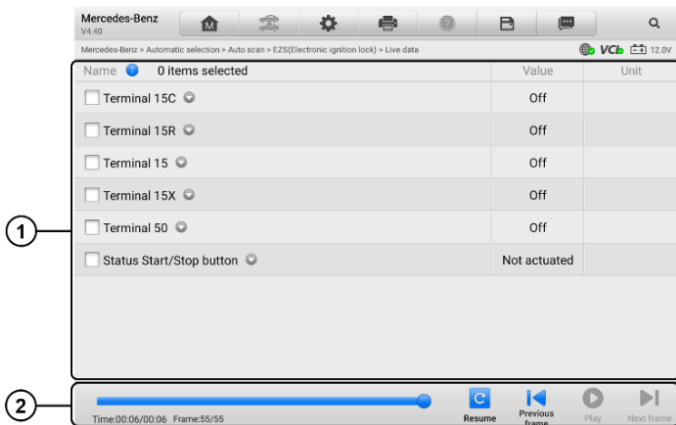

Figure 10-6 Data Playback Screen

1. Main Section — displays the recorded data frames.
2. Navigation Toolbar — allows you to manipulate data playback.

Use the Navigation Toolbar buttons to play back the record data from frame to frame.

Tap **Back** to exit data playback.

10.8 Data Logging

The Data Logging section allows you to launch the Support platform to view all records with or without feedback (saved) data logs on the diagnostics system. For more information, please refer to [Data Logging](#).

10.9 Uninstall Apps

This section allows you to manage the software application installed on the MaxiSys Diagnostics System. Selecting this section opens a management screen, on which you can check all the available vehicle diagnostics applications.

Select the vehicle software you want to delete by tapping on the car brand icon. The selected item will display a blue check mark on the upper-right corner. Tap the **Delete** button on the top bar to delete the software from the system database.

11 VCI Manager

The VCI Manager is for connecting the MaxiSys Elite II Pro tablet with a VCI through Bluetooth. This application allows you to pair the tablet with the VCI and to check its communication status.

11.1 VCI Connection via Bluetooth

The VCI needs to be either connected to a vehicle or to an available power source, so that it is powered up during the synchronization procedure. Make sure the tablet has a fully charged battery or is connected to an external power supply.

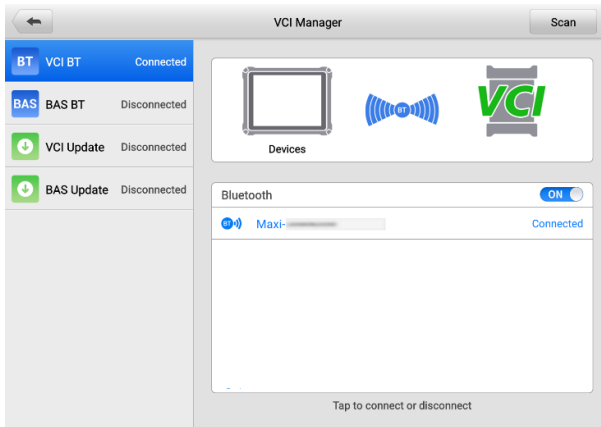

Figure 11-1 VCI Bluetooth Pairing Screen

➤ To pair the VCI with the tablet via Bluetooth

1. Power on the tablet.
2. Connect the 26-pin end of the main cable to the VCI's vehicle data connector.
3. Connect the 16-pin end of the main cable to the vehicle Data Link Connector (DLC).
4. Tap **VCI Manager** on the MaxiSys Job Menu.
5. Select **VCI BT** (short for VCI Bluetooth) from the connection mode list. Tap the Bluetooth toggle to turn it **ON**. The device will start searching for available units for pairing.
6. Depending on the VCI you use, the device name may appear as "Maxi" suffixed with the VCI's serial number. Select the appropriate device for pairing.
7. When paired successfully, the connection status reads "Connected."

- The VCI button on the system navigation bar at the bottom of the screen will display a green circle BT icon, indicating the tablet is connected to the VCI.

NOTE

A VCI can be paired with only one tablet at a time, and once it is been paired, the device will not be discoverable by any other unit.

11.2 BAS Connection via Bluetooth

The MaxiBAS BT506 battery tester needs to be either connected to a vehicle or to an available power source, so that it is powered up during the synchronization procedure. Make sure the tablet is fully charged or is connected to an external power supply.

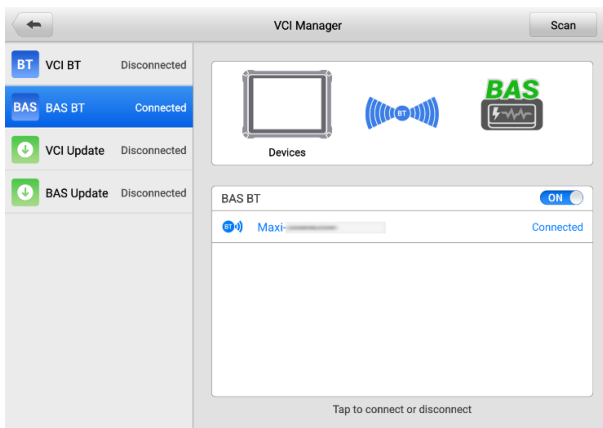

Figure 11-2 BAS Bluetooth Pairing Screen

- **To pair the BT506 battery tester with the tablet**
 - Turn on both the MaxiBAS BT506 and MaxiSys Elite II Pro tablet.
 - Tap **VCI Manager** on the MaxiSys Job Menu.
 - Select **BAS BT** from the connection mode list. Tap the BAS Bluetooth toggle to turn it **ON**. The tablet automatically scans for an available battery tester for Bluetooth pairing. The device name will appear as “Maxi” suffixed with a serial number.
 - Check the serial number of your BT506 battery tester and select the desired device on the tablet for pairing.
 - When paired successfully, the connection status will read as “Connected.”

11.3 VCI Update

The VCI Update provides the latest update for the MaxiFlash VCI. Before updating the VCI, please make sure the tablet network is stable.

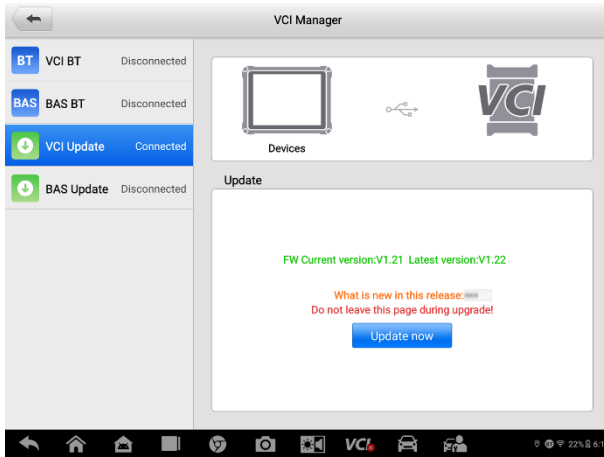

Figure 11-3 VCI Update Screen

➤ **To update the VCI**

1. Power on the tablet.
2. Connect the VCI to the tablet via Bluetooth or USB.
3. Tap **VCI Manager** on the MaxiSys Job Menu.
4. Select **VCI Update** from the connection mode list.
5. The current version and the latest version of the VCI will appear. Tap **Update Now** to update the VCI if available.

11.4 BAS Update

The BAS Update provides the latest update for the MaxiBAS BT506. Before updating the battery tester, please make sure the tablet network is stable.

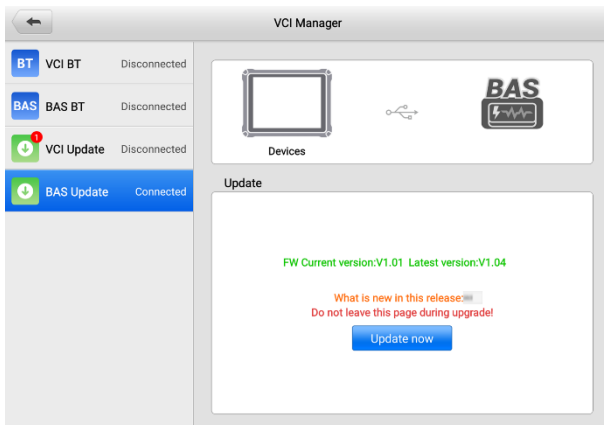

Figure 11-4 BAS Update Screen

➤ **To update the MaxiBAS BT506**

1. Power on the tablet and the MaxiBAS BT506.
2. Connect the MaxiBAS BT506 to the tablet via Bluetooth or USB.
3. Tap **VCI Manager** on the MaxiSys Job Menu.
4. Select **BAS Update** from the connection mode list.
5. The current version and the latest version of the MaxiBAS BT506 will appear. Tap **Update Now** to update the MaxiBAS BT506 if available.

ⓘ **NOTE**

Do not leave the BAS Update page during upgrade.

12 Update

The Update application allows you to download the latest software. The updates can improve the MaxiSys applications' capabilities, typically by adding new tests, new vehicle models or enhanced applications.

This section describes the update operations for the MaxiSys tablet. The tablet automatically searches for available updates for all of the MaxiSys software when it is connected to the Internet. Any updates that are found can be downloaded and installed on the tablet with a stable Internet connection.

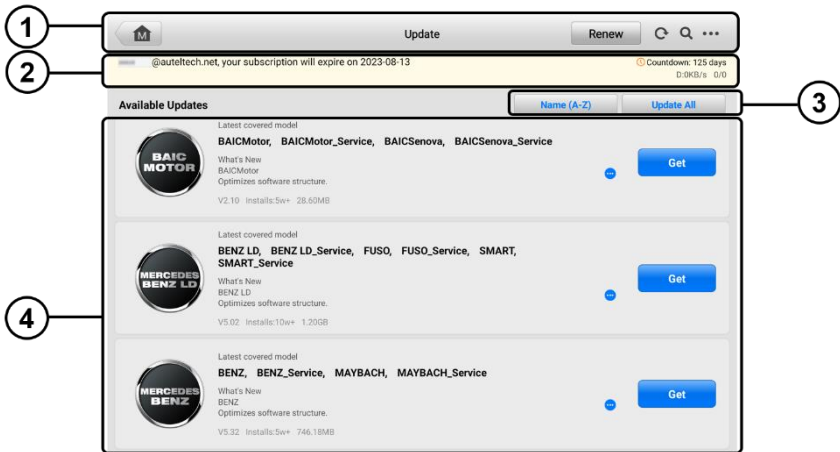

Figure 12-1 Update Screen

1. Navigation and Controls

- Home Button — returns to the MaxiSys Job Menu.
- Renew Button — extends subscription.
- Refresh — refreshes the interface.
- Search — searches specific update item by inputting the file name, for example, a specific vehicle manufacturer.
- More — includes three options: my devices, my orders, and my coupons.

2. Status Bar

- Left Side — displays the account information and the validity period of subscription.
- Right Side — displays the countdown for validity period of subscription; displays the download speed and update progress which indicates the completion status.

3. Function Button

- Name (A-Z) — tap to change the sort order of available updates. There are 5

ways to view updates: Date (Old to New), Date (New to Old), Frequency, Name (A–Z), and Name (Z–A).

- Update All — tap to select software for bulk download.

4. Main Section

- Left Column — displays vehicle logos.
- Middle Column — displays a brief introduction about the new changes to the software operation or capabilities. Tap  button to display an information screen to view more details, and tap the dim area around to close the window.
- Right Column — according to the operating status of each software item, the button appears differently.
 - a) Tap **Get** to update the selected item.
 - b) Tap **Pause** to suspend the updating procedure.
 - c) Tap **Continue** to go on updating the suspended update.

➤ To update the software

1. Power up the tablet, and ensure that it is connected to a power source and has a steady Internet connection.
2. Tap the **Update** application button on the MaxiSys Job Menu, or tap the update notification message when received. The Update application screen appears.
3. Check all available updates:
 - To update all items, tap the **Update All** button.
 - To update some items, tap the **Get** button on the right column of the specific item. This option is highly recommended to ensure updates are performed correctly, especially when you are unsure of the speed and stability of your Internet connection.
4. Tap the **Pause** button to suspend the updating process. Tap **Continue** to resume the update and the process will continue from the pause point.
5. When the updating process is completed, the software will be installed automatically. The new version will replace the older version.

13 Support

This application launches the Support platform which synchronizes Autel's online service base station with the MaxiSys tablet. In order to synchronize the device to your online account, you need to register the product through the Internet when you use it for the first time. The Support application is connected to Autel's service channel and online communities that provides the quickest way for problem solutions, send help requests to obtain direct service and support.

13.1 Product Registration

In order to get access to the Support platform and obtain update and other services from Autel, you are required to register the MaxiSys tablet the first time you use it. See [Autel User Center](#) for detailed information.

13.2 Support Screen Layout

The Support application interface is navigated by the **Home** button on the top navigation bar.

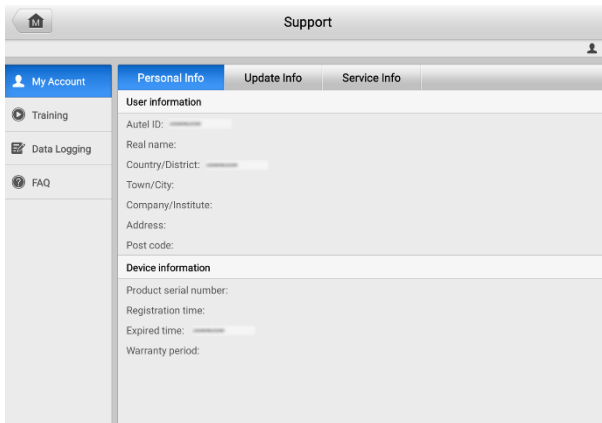

Figure 13-1 Support Application Screen

The main section of the Support screen is divided into two sections. The narrow column on the left is the main menu. Selecting one subject from the main menu displays the corresponding function interface on the right.

13.3 My Account

The My Account screen displays the comprehensive information of the user and the product, which is synchronized with the online registered account, including User Info, Device Info, Update Info, and Service Info.

13.3.1 Personal Info

The User Information and Device Information are both included under the Personal Info section.

- **User Information** — displays detailed information of your registered online Autel account, such as your Autel ID, name, address and other contact information.
- **Device Information** — displays the registered product information, including the serial number, registration date, expire date, and warranty period.

13.3.2 Update Info

The Update Info section displays a detailed list of the product's software update history, including the product serial number, software version or name, and the update time.

13.3.3 Service Info

The Service Info section displays a detailed record list of the device's service history information. Each time the device is sent back to Autel for repair, the device's serial number and the detailed repair information, such as the fault type, changed components, or system reinstallation, will be recorded and updated to the associated online product account that will be synchronized to the Service Info section.

13.4 Training

The Training section provides quick links to Autel's online video accounts. Select a video channel by language to see all available Autel online tutorial videos on such topics as product usage techniques and vehicle diagnostics practices.

13.5 Data Logging

The Data Logging section keeps records of all **Feedback** (submitted), **Not Feedback** (but saved) or **History** (up to the latest 20 test records) data loggings on the diagnostics system. The support personnel will receive and process the submitted reports through the Support platform. The solution will be sent back within 48 hours. You may continue to correspond with Support until the issue is resolved.



Figure 13-2 Data Logging Screen

➤ **To make a reply in a Data Logging session**

1. Tap the **Feedback** tab to view the submitted data loggings.
2. Select the latest message from Autel support service.
3. Tap the input field at the bottom of the screen and enter your reply. Additionally, tap the **Audio** button to record a voice message or tap the **Camera** button to take a screenshot.
4. Tap **Send** to send your reply to Support.

13.6 FAQ Database

The FAQ section provides comprehensive references for all questions frequently asked and answered about the use of Autel's online member account, shopping, and payment procedures.

- **Account** — displays questions and answers about the use of Autel's online user account.
- **Shopping & Payment** — displays questions and answers about online product purchase and payment methods or procedures.

14 MaxiViewer

MaxiViewer allows you to search the functions supported by our tools and the version information. There are two ways of searching, either by searching the tool and the vehicle or searching the functions.

➤ To search by vehicle

1. Tap the **MaxiViewer** application on the MaxiSys Job Menu.
2. Tap the tool name on the top-left to drop down the tool list, and tap the one you want to search.
3. Choose the vehicle brand, model, and year you want to search.

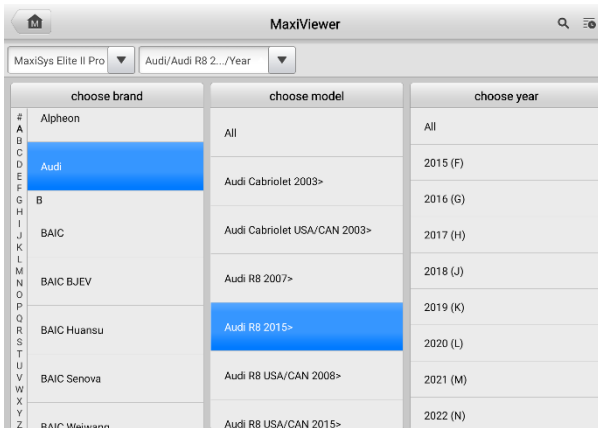

Figure 14-1 MaxiViewer Screen

4. All the functions supported by the selected tool for the selected vehicle are displayed such as vehicle's system, function, sub function, version, and more.

➤ To search by the functions

1. Tap the **MaxiViewer** application on the MaxiSys Job Menu.
2. Tap the tool name on the top-left to drop down the tool list, and choose the one you want to search.
3. Enter the function you want to search in the top-right search box. The screen will display all vehicles that support this function, along with information such as the vehicles' year, system, capacity, type, series, function, sub-function, and version.

NOTE

Fuzzy search is supported.

15 MaxiScope

The MaxiScope application configures the MaxiSys Diagnostics Device to operate as an automotive oscilloscope when used in combination with the MaxiScope module. This function provides all the features needed for performing electrical and electronic circuit tests as well as monitoring signal activities on any modern vehicles, which shows you what is really going on with a vehicle's electrical system.

Please download the latest user manual for Autel MaxiScope device from www.autel.com > **Specialty Tools** > **MORE PRODUCTS** > **MaxiScope MP408** > **Downloads**.

16 MaxiVideo

The MaxiVideo application configures the MaxiSys tablet to operate as a digital video scope by simply connecting the tablet to a MaxiVideo camera. This function allows you to examine difficult-to-reach areas normally hidden from sight, with the ability to record digital still images and videos, which offers you an economical solution to inspect machinery, facilities, and infrastructure in a safe and quick way.

Two sizes of imager head are available: 8.5 mm and 5.5 mm.

NOTE

The MaxiVideo camera and its fittings are optional. Please purchase them separately. For detailed product operation instructions, please refer to the Quick Reference Guide of the MaxiVideo camera.

17 Quick Link

The Quick Link application provides you with convenient access to Autel's official website and many other well-known sites in automotive service, which offers you abundant information and resources, such as technical help, knowledge bases, forums, training, and expert consultations.

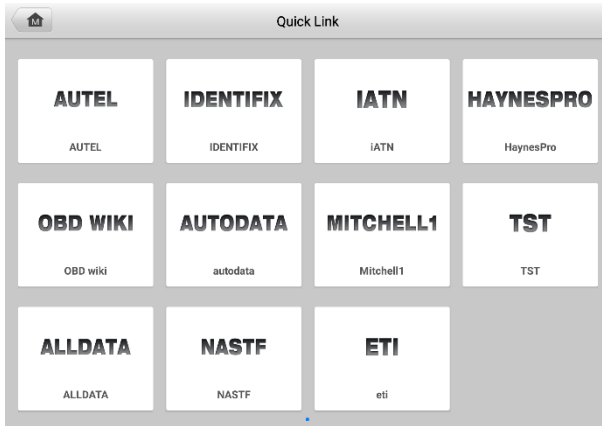

Figure 17-1 Quick Link Screen

➤ **To open a quick link**

1. Tap **Quick Link** on the MaxiSys Job Menu. The Quick Link application screen displays.
2. Select a website thumbnail from the main section. The Chrome browser is launched and the selected website is opened.
3. Now you can start exploring the website.

18 Remote Desktop

The Remote Desktop application launches the TeamViewer Quick Support program, which is a simple, fast, and secure remote control interface. You can use the application to receive ad-hoc remote support from Autel's support center, colleagues or friends, by allowing them to control your MaxiSys tablet on their PC via the TeamViewer software.

18.1 Operations

If you think of a TeamViewer connection as a phone call, the TeamViewer ID would be the phone number, under which all TeamViewer clients can be reached separately. Computers and mobile devices that run TeamViewer are identified by a globally unique ID. The first time the Remote Desktop application is started, this ID is generated automatically based on the hardware characteristics and will not change.

Make sure the tablet is connected to the Internet before launching the Remote Desktop application, so that the tablet is able to receive remote support from a third party.

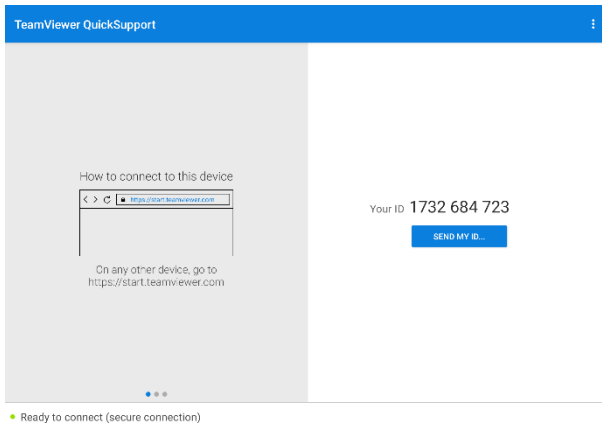

Figure 18-1 Remote Desktop Screen

➤ **To receive remote support from a partner**

1. Power on the tablet.
2. Tap the **Remote Desktop** application on the MaxiSys Job Menu. The TeamViewer interface displays and the device ID is generated and shown.
3. Your partner must install the Remote Control software to the computer by downloading the TeamViewer full version program online (<http://www.teamviewer.com>). Start the software on the computer at the same time in order to provide support and take control of the tablet remotely.

4. Provide your ID to the partner, and wait for him/her to send you a remote control request.
5. A message displays to ask for your confirmation to allow remote control on your device.
6. Tap **Allow** to accept or tap **Deny** to reject.

19 User Feedback

The User Feedback feature allows you to submit questions related to this product.

The image shows a mobile application screen titled "User feedback". At the top, there is a back arrow on the left and a user profile icon on the right. The form contains several fields: "Serial number" with a text input; "Telephone/Email" with a text input; "Feedback type" with four radio button options: "Hardware Problem" (selected), "Software Problem", "Optimization Suggestion", and "Other"; "Theme" with a dropdown menu; and "Problem description" with a text input. Below these fields is a media selection section with icons for "Recording voice", "Album", "Photo", "Shot", and "Local files". At the bottom, there is a "Files" section showing a list of attachments and a blue "Submit" button on the right.

Figure 19-1 User Feedback Screen

➤ To send new user feedback

1. Register the product online, see [Autel User Center](#) for detailed information.
2. Tap **User Feedback** on the MaxiSys Job Menu. The device information is automatically synchronized with the online account.
3. Enter your telephone number/email address, feedback type, theme, and problem description. You can also attach a voice recording, photo, photo album, screen captures, image or PDF files with the form. To help resolve the issue efficiently, we recommend you to complete the form with as many details as possible.
4. Tap **Submit** to send the completed form to Autel's online service center. The submitted feedback will be carefully read and handled by our support personnel.

20 Autel User Center

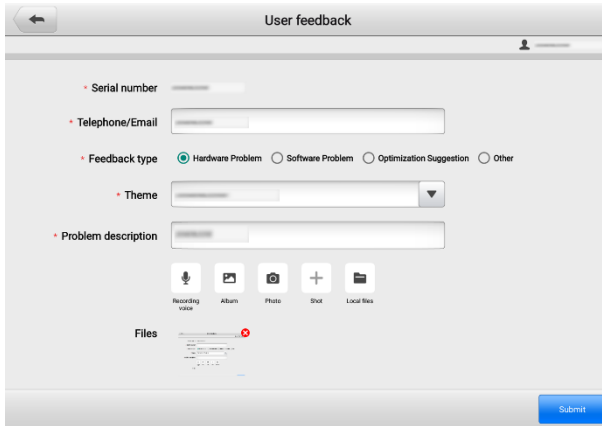
The Autel User Center application allows you to register your tool to download the latest released software, thereby enhancing the functionality of the MaxiSys application by adding new vehicle models or enhanced applications to the database.

There are two ways for product registration:

A. Register the product using the MaxiSys tablet

➤ **To log in with your account and register your tool**

1. Tap **Autel User Center** from the MaxiSys Job Menu. The following screen displays.

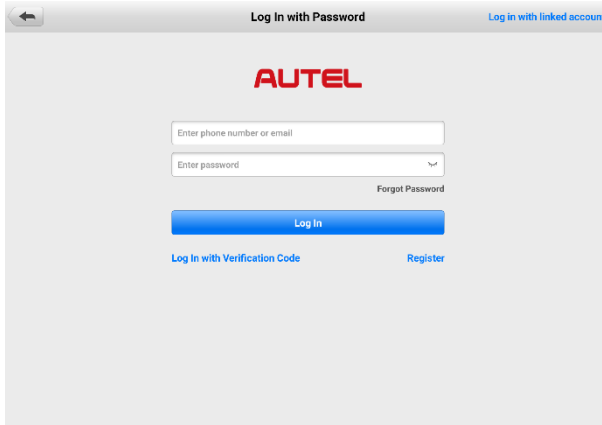

Figure 20-1 Autel User Center Screen

2. If you already have an Autel ID, you can log in with your phone number and verification code, or tap **Log In with Password** to log in with your Autel ID and password. If you do not have an Autle ID yet, tap **Register** to create an Autel ID.
3. Once your account is successfully registered, you will enter the main menu of the Autel User Center.
4. Select **Device Management** on the main menu.
5. Tap the **Link Device** button on the upper-right corner of the Device Management screen. The serial number and password of the device will automatically appear on the Link Device screen.
6. Tap the **Link** button to complete the product registration.

B. Register the product on the Autel website

➤ To register the diagnostics device

1. Visit the website: pro.autel.com.
2. If you have an Autel account, log in and skip to Step 7.
3. If you are a new member to Autel, click **Register** to create your Autel ID.
4. Enter your personal information. Fields marked with an asterisk (*) are mandatory.
5. After all the mandatory information is entered, read the **Autel User Service Agreement** and **Autel Privacy Policy**, then check the box to accept the terms and click **Register**.
6. Once your account is successfully registered, you will be redirected to the Product Registration screen. If not, click the button on the screen.
7. Your product serial number and password are required to enter. To find your serial number and password on the tablet: go to **Settings** > **About**.
8. Enter your tablet's serial number and password.
9. Enter the CAPTCHA code and click **Submit** to complete your product registration.

21 Maintenance and Service

To ensure that the tablet and the combined VCI perform at their optimum level, we advise that the product maintenance instructions in this section are strictly followed.

21.1 Maintenance Instructions

The following includes how to maintain your devices, together with precautions to take.

- Use a soft cloth dampened with alcohol or mild glass cleaner to clean the tablet touchscreen at the end of each work day.
- Do not use any abrasive cleansers, detergent or automotive chemicals on the tablet.
- Keep the devices in dry conditions and within specified operating temperatures.
- Dry your hands before using the tablet. The touchscreen of the tablet may not work when it is moist, or when you tap the touchscreen with wet hands.
- Do not store the devices in humid, dusty or dirty areas.
- Check the housing, wiring, and connectors for dirt and damage before and after each use.
- Do not attempt to disassemble your tablet or the VCI unit.
- Do not drop or cause severe impact to the devices.
- Use only authorized battery chargers and accessories. Any malfunction or damage caused by the use of unauthorized battery charger or accessories will void the limited product warranty.
- Ensure that the battery charger does not contact conductive objects.
- Do not use the tablet beside microwave ovens, cordless phones and certain medical or scientific instruments to prevent signal interference.

21.2 Troubleshooting Checklist

A. When the tablet does not work properly:

- Make sure the tablet has been registered online.
- Make sure the system software and diagnostic application are properly updated.
- Make sure the tablet is connected to the Internet.
- Check all cables, connections, and indicators to see if the signal is being received.

B. When battery life is shorter than usual:

- This may happen when you are in an area with low signal strength. Turn off your device if it is not in use.

C. When you cannot turn on the tablet:

- Make sure the tablet is connected to a power source or the battery is fully charged.

D. When you are unable to charge the tablet:

- Your charger maybe out of order. Contact your nearest dealer.
- You may be attempting to use the device in an overly hot/cold temperature. Charge the device in a temperate area.
- Your device may not be connected to the charger properly. Check the connector.

 **NOTE**

If the problems persist, please contact Autel's technical support personnel or your local selling agent.

21.3 About Battery Usage

Your tablet is powered by a built-in lithium-ion polymer battery, which enables you to recharge your battery when there is electricity left.

 **DANGER**

The built-in lithium-ion polymer battery is factory-replaceable only. Incorrect replacement or tampering with the battery pack may cause an explosion.

- Do not use a damaged battery charger.
- Do not disassemble, open, crush, bend, deform, puncture, or shred the battery.
- Do not modify, remanufacture or attempt to insert foreign objects into the battery, or expose the battery to fire, explosion, or other hazards.
- Only use the specified charger and USB cables. Use of non-Autel-authorized charger or USB cables may lead to device malfunction or failure.
- Use of an unqualified battery or charger may present a risk of fire, explosion, leakage, or other hazards.
- Avoid dropping the tablet. If the tablet is dropped, especially on a hard surface, and you suspect damage, take the tablet to a service center for inspection.
- Try to keep closer to your wireless router to reduce battery usage.
- The time needed to recharge the battery varies depending on the remaining battery capacity.
- Battery life inevitably shortens over time.
- Unplug the charger once the tablet is fully charged since overcharging may shorten battery life.
- Keep the battery in temperate environments. Do not place it inside a car when it is too hot or too cold, which may reduce the capacity and life of the battery.

21.4 Service Procedures

This section provides information on technical support, repair service, and application for replacement or optional parts.

21.4.1 Technical Support

If you have any question or problem on product operations, please contact us.

AUTEL NORTH AMERICA

- **Phone:** 1-855-AUTEL-US (855-288-3587) Monday-Friday 9AM-6PM Eastern Time
- **Website:** www.autel.com
- **Email:** sales@autel.com; ussupport@autel.com
- **Address:** 36 Harbor Park Drive, Port Washington, New York, USA 11050

AUTEL EUROPE

- **Phone:** +49(0)89 540299608 Monday-Friday, 9:00AM-6:00PM Berlin Time
- **Website:** www.autel.eu
- **Email:** salesoffice.eu@autel.com; support.eu@autel.com
- **Address:** Landsberger Str. 408, 4. OG, 81241 München, Germany

AUTEL CHINA HEADQUARTER

- **Phone:** +86-0755-8614-7779 Monday-Friday, 9:00AM-6:00PM Beijing Time
- **Website:** www.auteltech.cn
- **Email:** sales@auteltech.net; support@autel.com
- **Address:** 7-8th, 10th Floor, Building B1, Zhiyuan, Xueyuan Road, Xili, Nanshan, Shenzhen, 518055, China

AUTEL APAC

- **Phone:** +81-045-548-6282
- **Website:** www.autel.com/jp/
- **Email:** sales.jp@autel.com; support.jp@autel.com
- **Address:** 6th Floor, Ari- Nadoribiru 3-7-7, Shin-Yokohama, Kouhoku-Ku, Yokohama-Shi, Kanagawa-Ken, 222-0033 Japan

AUTEL IMEA

- **Phone:** +971 585 002709
- **Website:** www.autel.com
- **Email:** sales.imea@autel.com; imea-support@autel.com

- **Address:** 906-17, Preatoni Tower (Cluster L), Jumeirah Lakes Tower, DMCC, Dubai, UAE

AUTEL LATIN AMERICA

- **Phone:** +52 33 1001 7880 (Spanish in Mexico), +55 19 97816 4911 (Portuguese in Brazil)
- **Website:** www.autel.com
- **Email:** sales.latin@autel.com; latsupport@autel.com; brsupport@autel.com
- **Address:** Avenida Americas 1905, 6B, Colonia Aldrete, Guadalajara, Jalisco, Mexico

For technical assistance in other markets, please contact your local selling agent.

21.4.2 Repair Service

If it is necessary to send back your device for repair, please download and fill out the repair service form from www.autel.com. The following information must be included:

- Contact name
- Return address
- Telephone number
- Product name
- Complete description of the problem
- Proof-of-purchase for warranty repairs
- Preferred method of payment for non-warranty repairs

NOTE

For non-warranty repairs, payment can be made with Visa, Master Card, or with approved credit terms.

Send the device to your local agent, or to the address below:

7-8th, 10th Floor, Building B1, Zhiyuan, Xueyuan Road, Xili, Nanshan, Shenzhen, 518055, China

21.4.3 Other Services

You can purchase the accessories directly from authorized tool suppliers of Autel, or your local distributor or agent.

Your purchase order should include the following information:

- Contact information
- Product or part name

- Item description
- Purchase quantity

22 Compliance Information

FCC Compliance

FCC ID: WQ8-MS908S2122

This equipment has been tested and verified to comply with the limits for a Class B digital device, pursuant to Part 15 of the FCC Rules. These limits are designed to provide reasonable protection against harmful interference in a residential installation. This equipment generates uses and can radiate radio frequency energy and, if not installed and used in accordance with the instructions, may cause harmful interference to radio communications. However, there is no guarantee that interference will not occur in a particular installation. If this equipment does cause harmful interference to radio or television reception, which can be determined by turning the equipment off and on, the user is encouraged to correct the interference by one or more of the following measures:

- Reorient or relocate the receiving antenna.
- Increase the separation between the equipment and receiver.
- Consult the dealer or an experienced radio/TV technician for help.

This device complies with part 15 of the FCC Rules. Operation is subject to the following two conditions:

- (1) This device may not cause harmful interference, and
- (2) This device must accept any interference received, including interference that may cause undesired operation.

Changes or modifications not expressly approved by the party responsible for compliance could void the user's authority to operate the equipment.

SAR:

The radiated output power of this device is below the FCC radio frequency exposure limits. Nevertheless, the device should be used in such a manner that the potential for human contact is minimized during normal operation.

The exposure standard for wireless devices employs a unit of measurement known as the Specific Absorption Rate, or SAR. The SAR limit set by the FCC is 1.6 W/Kg. Tests for SAR are conducted using standard operating positions accepted by the FCC with the device transmitting at its highest certified power level in all tested frequency bands. Although the SAR is determined at the highest certified power level, the actual SAR level of the device while operating can be well below the maximum value. This is because the device is designed to operate at multiple power levels to use only the power required to reach the network. To avoid the possibility of exceeding the FCC radio frequency exposure limits, human proximity to antenna should be minimized.

RoHS Compliance

This device is declared to be in compliance with the European RoHS Directive 2011/65/EU.

CE Compliance

This product is declared to conform to the essential requirements of the following directives and carries the CE mark accordingly:

Radio Equipment Directive 2014/53/EU.

23 Warranty

23.1 12-Month Limited Warranty

Autel Intelligent Technology Corp., Ltd. (the Company) warrants to the original retail purchaser of this MaxiSys diagnostics device that should this product or any part thereof during normal usage and under normal conditions be proven defective in material or workmanship that results in product failure within twelve (12) months period from the date of purchase, such defect(s) will be repaired, or replaced (with new or rebuilt parts) with Proof of Purchase, at the Company's option, without charge for parts or labor directly related to the defect(s).

NOTE

If the warranty period is inconsistent with local laws and regulations, please comply with the relevant local laws and regulations.

The Company shall not be liable for any incidental or consequential damages arising from the use, misuse, or mounting of the device. Some states do not allow limitation on how long an implied warranty lasts, so the above limitations may not apply to you.

This warranty does not apply to:

- a) Products subjected to abnormal use or conditions, accident, mishandling, neglect, unauthorized alteration, misuse, improper installation or repair or improper storage;
- b) Products whose mechanical serial number or electronic serial number has been removed, altered or defaced;
- c) Damage from exposure to excessive temperatures or extreme environmental conditions;
- d) Damage resulting from connection to, or use of any accessory or other product not approved or authorized by the Company;
- e) Defects in appearance, cosmetic, decorative or structural items such as framing and non-operative parts.
- f) Products damaged from external causes such as fire, dirt, sand, battery leakage, blown fuse, theft or improper usage of any electrical source.

IMPORTANT

All contents of the product may be deleted during the process of repair. You should create a back-up copy of any contents of your product before delivering the product for warranty service.
