

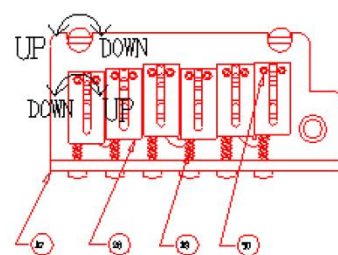

# Eart Guitars

Instruction Manual

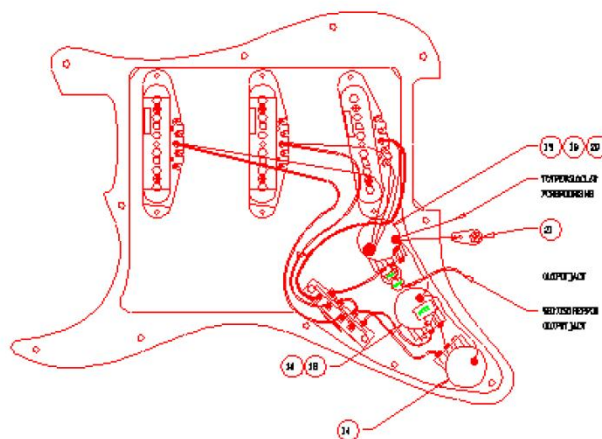

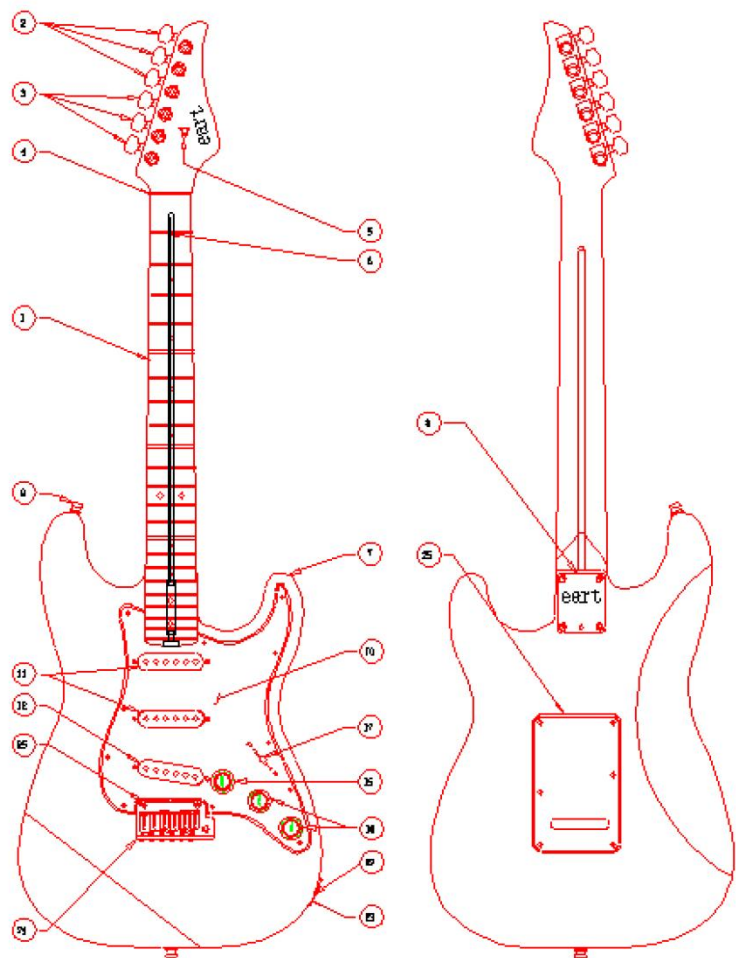

REF. #	DESCRIPTION
1	Neck
2	TuningKey
3	TuningKey
4	BoneNut
5	StringRetainer
6	TrussRodAdjustingWrench
7	Body
8	NeckMountingPlate
9	StrapButton
10	Pickguard
11	Pickup, Neck/Middle.
12	Pickup, Bridge
13	Control
14	Control
15	Knob, Volume
16	Knob, Tone
17	Switch, Lever 5-Position
18	Capacitor
19	Capacitor
20	Resistor
21	SolderLug
22	OutputJack
23	Ferrule, Jack
24	BridgeAssembly
25	PivotScrew Insert
26	BackPlate, Tremolo, Aged
27	BridgePlate
28	BridgeSection
29	IntonationScrew
30	HeightAdjustmentScrew, 1&6

### action

action is the distance between the fret and the strings.

If we want to measure action, we need to set the intonation accurately. Then it is necessary to place the ruler in the 14th fret and measure the distance between the top of the fret and the bottom of the string. Generally speaking, the action of the first fret should be 1.5-1.7mm, and the action of the sixth fret should be 2.0mm--2.2mm.

The method of adjustment is to gradually increase the action from low to high from the first fret. If the action is too high. The guitar will be difficult to play. If the action is too low, phenomena such as punches, silent notes, or lack of sustains may occur. If the action is correct, or if there is still a beating or silent phenomenon, you may need to adjust the neck reinforcement.

### Neck adjustment

The neck is continuously pulled by the strings, and the curvature of the neck is not only affected by the stability of the neck and the thickness of the strings, also changes with temperature and humidity.

If the action and intonation are correctly adjusted, but there is still a case of silent play or note, we need to adjust the curvature of the neck.

1. Check the curvature of the neck. After the intonation is set, press the first string at the first fret and hold the neck at the junction of the body, and then measure the gap between the string and the fret at the eighth fret. The gap of the lowest string is measured in the same way, and then adjusted so that the gap is within 0.3mm-0.5mm.

2. If the clearance is less than 0.3mm, you need to adjust the neck truss rod according to the direction "A" to make the curve of the neck more concave.

3. If the gap is higher than 0.5mm, you need to adjust the neck truss rod according to the direction "B" to make the curvature of the neck more convex.

※ Adjust the reinforcement nut 1/4 turn each time, while checking the tuning results.

### note

The neck must be carefully adjusted. Adjusting with too much force can damage your guitar.

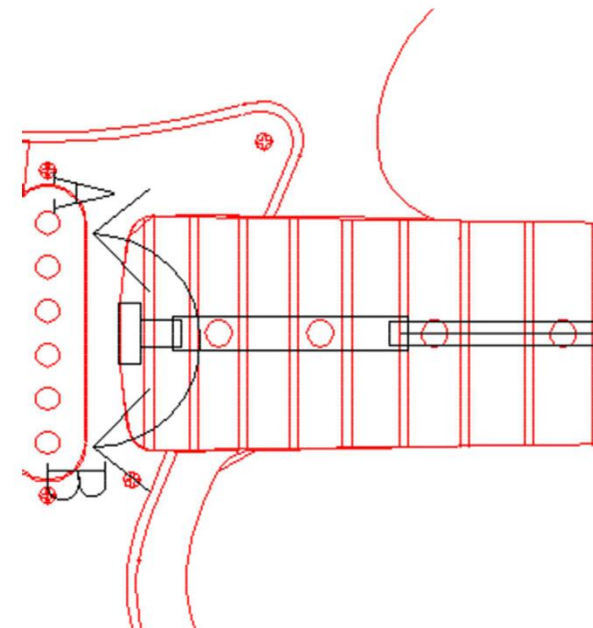

## bridge adjustment

Modern Two-Point Synchronized Tremolo

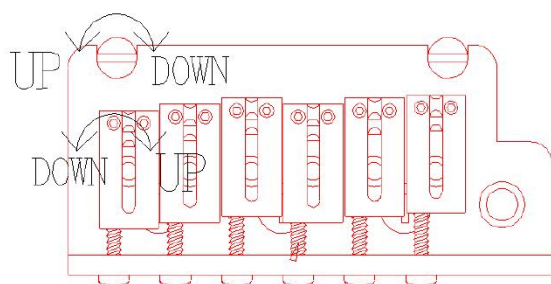

Vintage 6-point Synchronized Tremolo

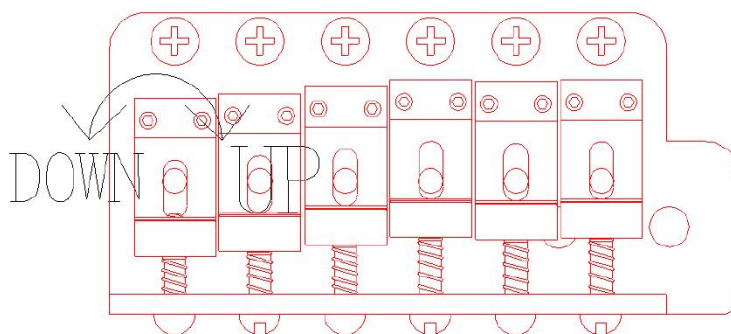

## pickups adjustment

pickups	bass side	treble side
vintage style	2.4mm	2mm
standard single-coil	2mm	1.6mm
humbucking	1.6mm	1.6mm

## control

2 humbuckers, 1 volume, 1 tone, 3way blade

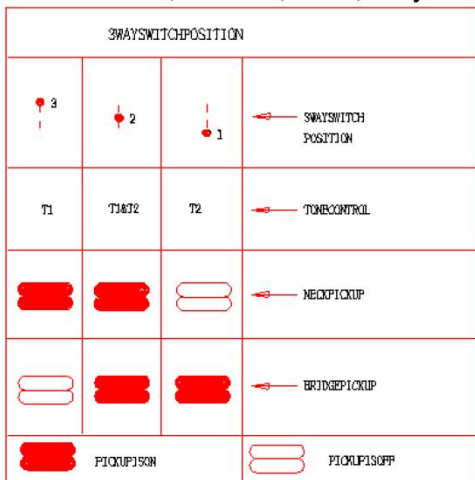

2single coils, 1humbucker, 1volume, 2tone, 5way blade

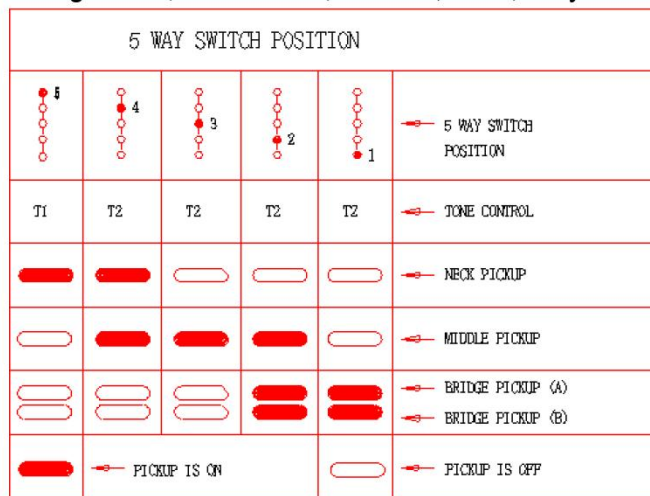

3single coils, 1volume, 2tone, 5 way blade

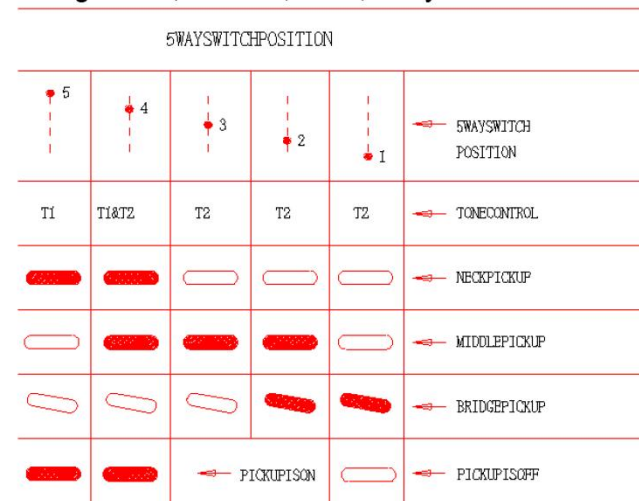

3single coils, 1volume, 2tone(Push-Pull for Bridge Pickup Bypass), 5 way blade

2single coils, 1humbucker, 1volume, Neck Tone(Push-Pull for Pickup Bypass), Middle/Bridge Tone (Push-Pull for Coil Split), 5 Way Blade Switch

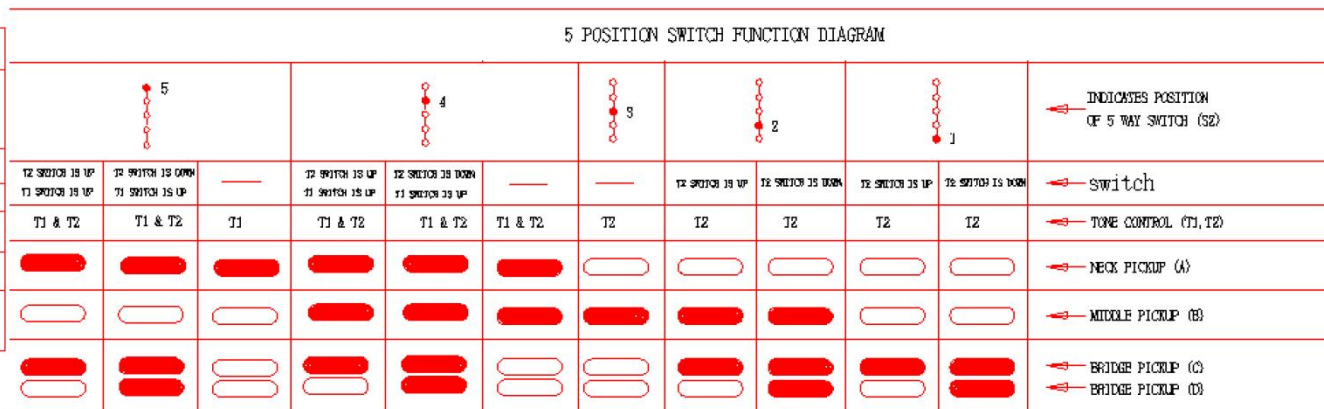
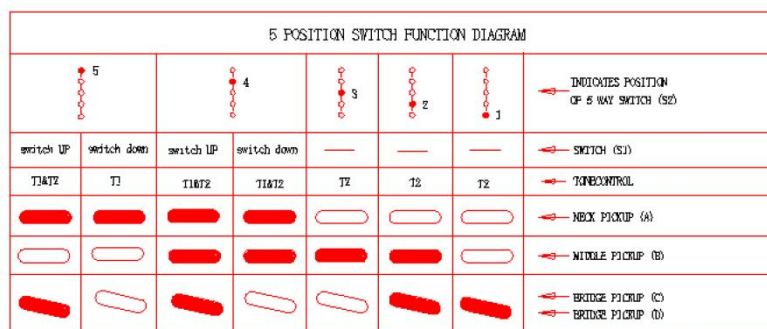

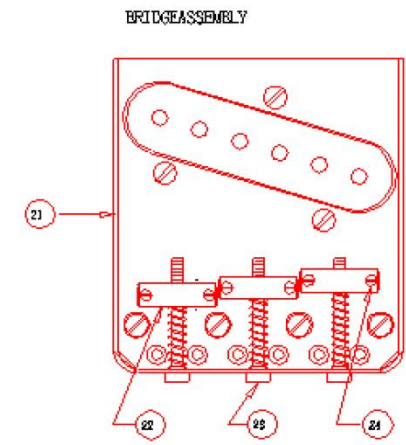
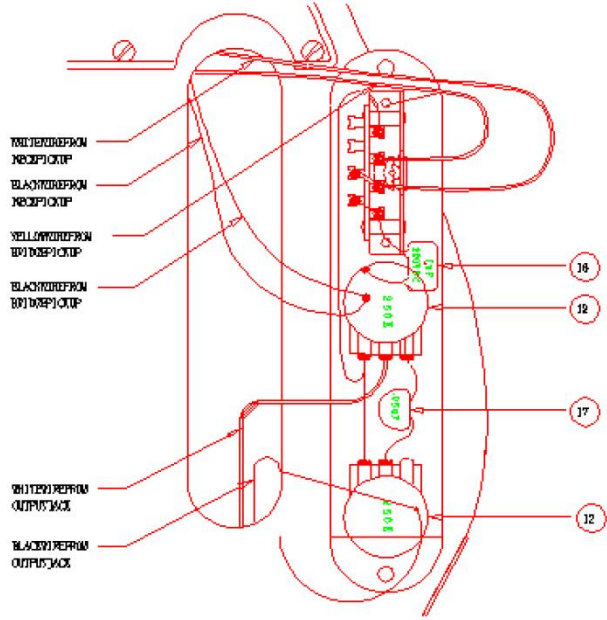
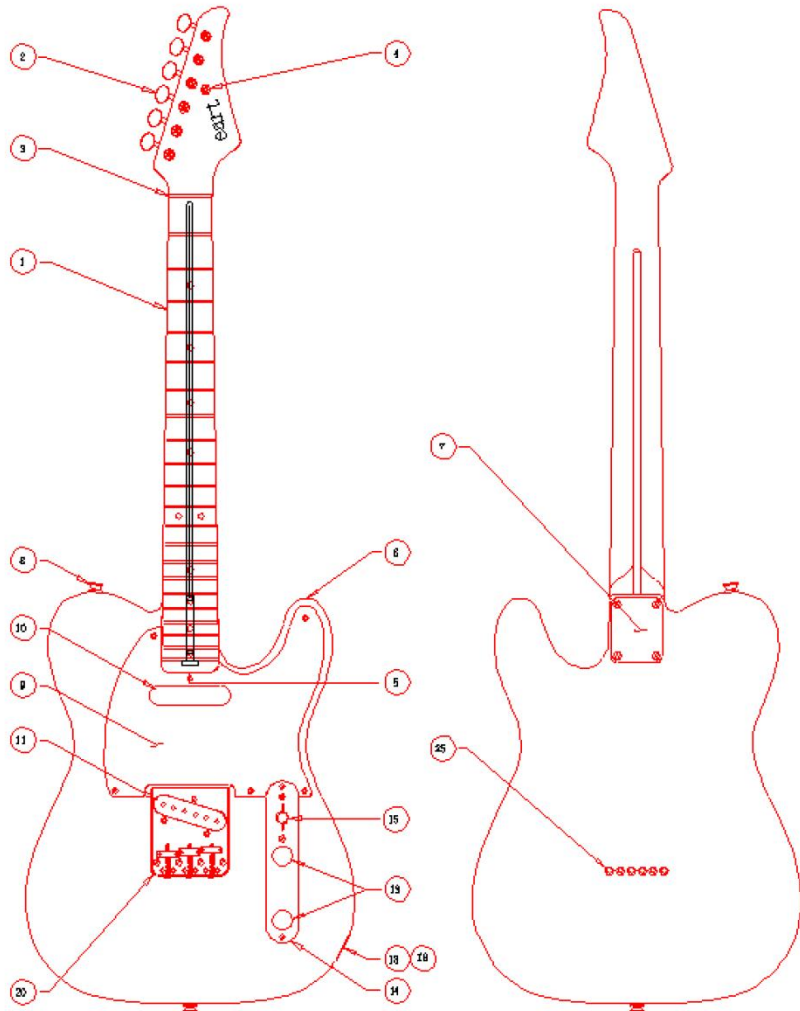

REF #	DESCRIPTION
1	Neck
2	TuningKey
3	BoneNut
4	StringRetainer
5	TrussRodAdjustmentNut
6	Body
7	NeckMountingPlate
8	StrapButton
9	Pickguard
10	Pickup, Neck
11	Pickup, Bridge
12	Control
13	Knob, Knurled
14	ControlPlate
15	Switch, Lever3-Position
16	Capacitor
17	Capacitor
18	OutputJack
19	JackFerrule
20	BridgeAssembly, VintageTelecaster
21	BridgePlate
22	BridgeSection, (3)
23	IntonationScrew, (3)
24	HeightAdjustmentScrew, (6)
25	StringRetainerFerrule

### action

action is the distance between the fret and the strings.

If we want to measure action, we need to set the intonation accurately. Then it is necessary to place the ruler in the 14th fret and measure the distance between the top of the fret and the bottom of the string. Generally speaking, the action of the first fret should be 1.5-1.7mm, and the action of the sixth fret should be 2.0mm--2.2mm.

The method of adjustment is to gradually increase the action from low to high from the first fret. If the action is too high. The guitar will be difficult to play. If the action is too low, phenomena such as punches, silent notes, or lack of sustains may occur. If the action is correct, or if there is still a beating or silent phenomenon, you may need to adjust the neck reinforcement.

### Neck adjustment

The neck is continuously pulled by the strings, and the curvature of the neck is not only affected by the stability of the neck and the thickness of the strings, also changes with temperature and humidity.

If the action and intonation are correctly adjusted, but there is still a case of silent play or note, we need to adjust the curvature of the neck.

1. Check the curvature of the neck. After the intonation is set, press the first string at the first fret and hold the neck at the junction of the body, and then measure the gap between the string and the fret at the eighth fret. The gap of the lowest string is measured in the same way, and then adjusted so that the gap is within 0.3mm-0.5mm.

2. If the clearance is less than 0.3mm, you need to adjust the neck truss rod according to the direction "A" to make the curve of the neck more concave.

3. If the gap is higher than 0.5mm, you need to adjust the neck truss rod according to the direction "B" to make the curvature of the neck more convex.

※ Adjust the reinforcement nut 1/4 turn each time, while checking the tuning results.

### note

The neck must be carefully adjusted. Adjusting with too much force can damage your guitar.

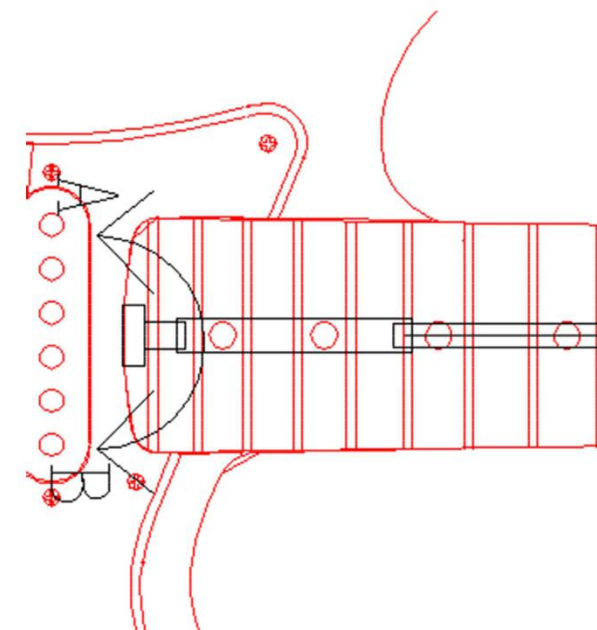

## bridge adjustment

Traditional 3-Saddle String Through Body Bridge

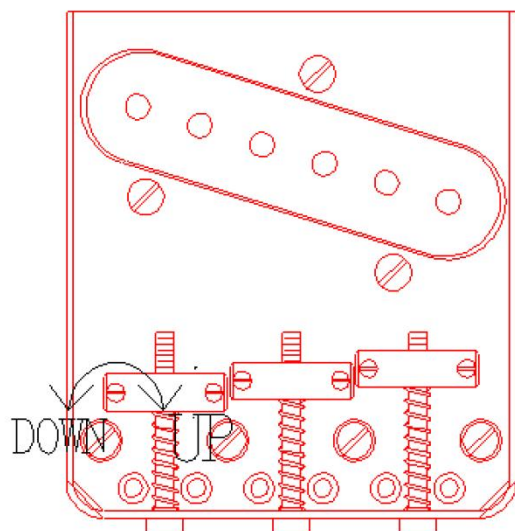

## control

3WAYSWITCHPOSITION			
			← 3WAYSWITCH POSITION
	T0	T1	← TONECONTROL
			← NECKPICKUP
			← BRIDGEPICKUP
	PICKUPOISON		
			PICKUPOFF

## pickups adjustment

pickups	bass side	treble side
vintage style	2.4mm	2mm
standard single-coil	2mm	1.6mm
humbucking	1.6mm	1.6mm



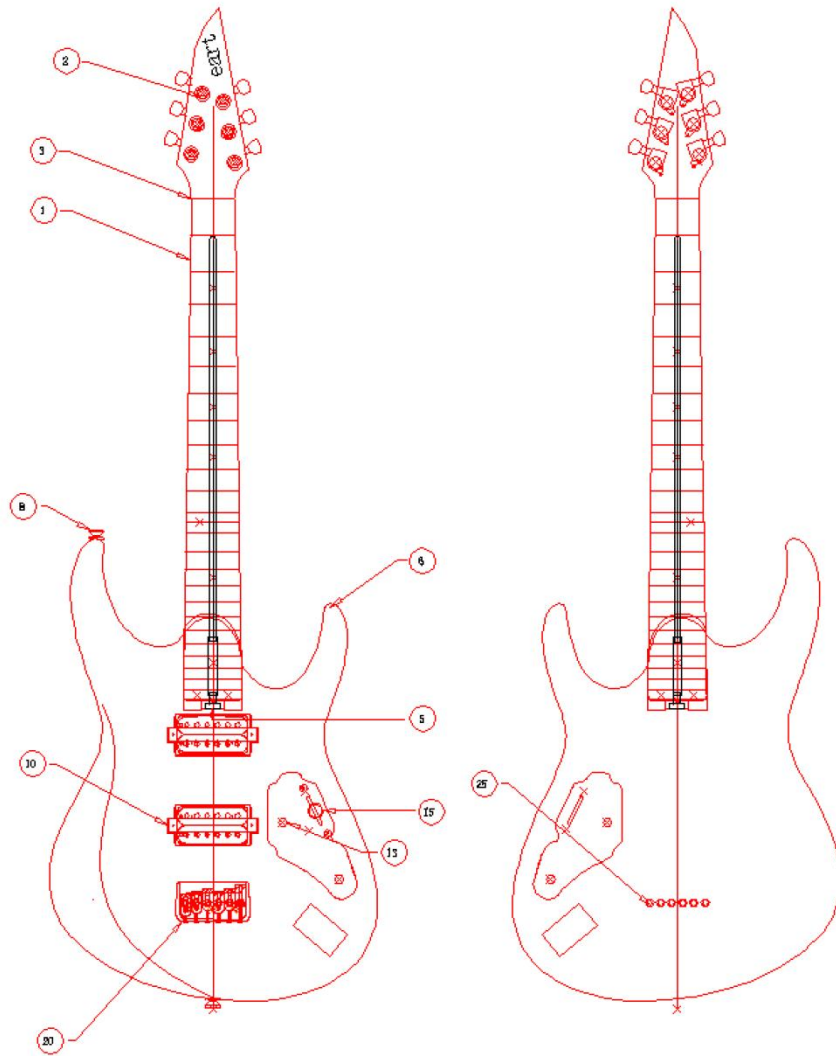

REF. #	DESCRIPTION
1	Neck
2	TuningKey
3	BoneNut
4	StringRetainer
5	TrussRodAdjustmentNut
6	Body
8	StrapButton
10	Pickup
13	Knob, Knurled
15	Switch, Lever3-Position
20	Bridge
25	StringRetainerFerrule

### action

action is the distance between the fret and the strings.

If we want to measure action, we need to set the intonation accurately. Then it is necessary to place the ruler in the 14th fret and measure the distance between the top of the fret and the bottom of the string. Generally speaking, the action of the first fret should be 1.5-1.7mm, and the action of the sixth fret should be 2.0mm--2.2mm.

The method of adjustment is to gradually increase the action from low to high from the first fret. If the action is too high. The guitar will be difficult to play. If the action is too low, phenomena such as punches, silent notes, or lack of sustains may occur. If the action is correct, or if there is still a beating or silent phenomenon, you may need to adjust the neck reinforcement.

### Neck adjustment

The neck is continuously pulled by the strings, and the curvature of the neck is not only affected by the stability of the neck and the thickness of the strings, also changes with temperature and humidity.

If the action and intonation are correctly adjusted, but there is still a case of silent play or note, we need to adjust the curvature of the neck.

1. Check the curvature of the neck. After the intonation is set, press the first string at the first fret and hold the neck at the junction of the body, and then measure the gap between the string and the fret at the eighth fret. The gap of the lowest string is measured in the same way, and then adjusted so that the gap is within 0.3mm-0.5mm.

2. If the clearance is less than 0.3mm, you need to adjust the neck truss rod according to the direction "A" to make the curve of the neck more concave.

3. If the gap is higher than 0.5mm, you need to adjust the neck truss rod according to the direction "B" to make the curvature of the neck more convex.

※ Adjust the reinforcement nut 1/4 turn each time, while checking the tuning results.

### note

The neck must be carefully adjusted. Adjusting with too much force can damage your guitar.

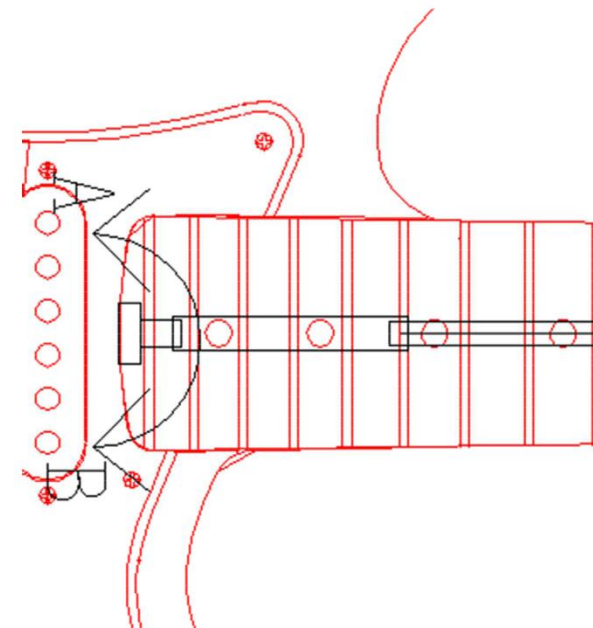

## bridge adjustment

Solid Brass Hardtail

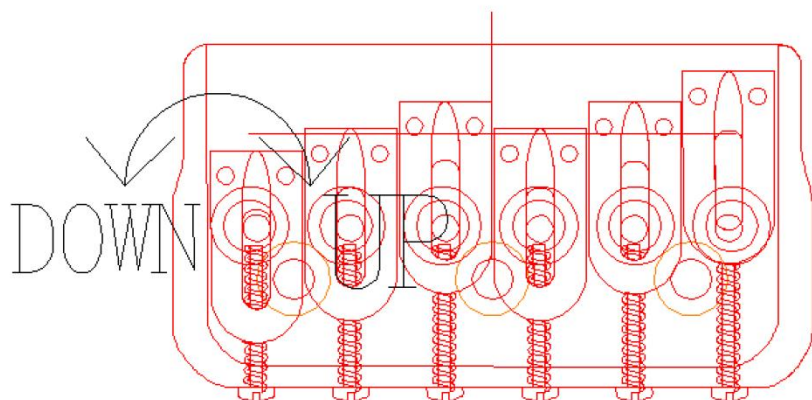

## pickups adjustment

pickups	bass side	treble side
vintage style	2.4mm	2mm
standard single-coil	2mm	1.6mm
humbucking	1.6mm	1.6mm

## control

3WAYSWITCHPOSITION			
3	2	1	3WAYSWITCH POSITION
T1	T1&T2	T2	ONECONTROL
			NECKPICKUP
			BRIDGEPICKUP
	PICKUPISON		PICKUPTSÖPP

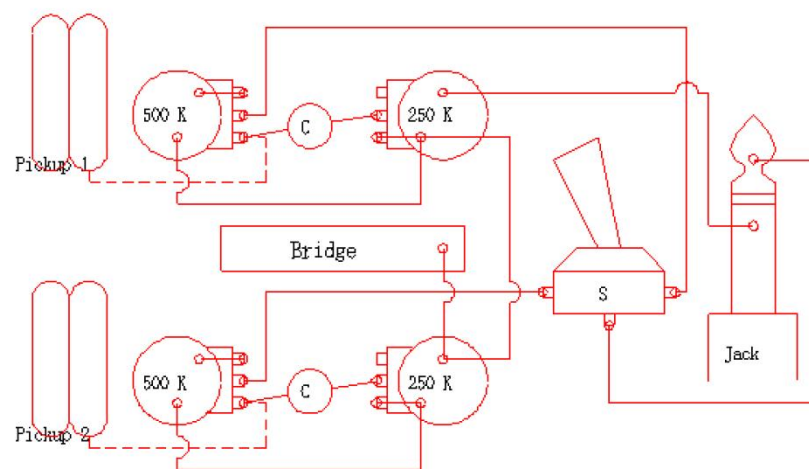
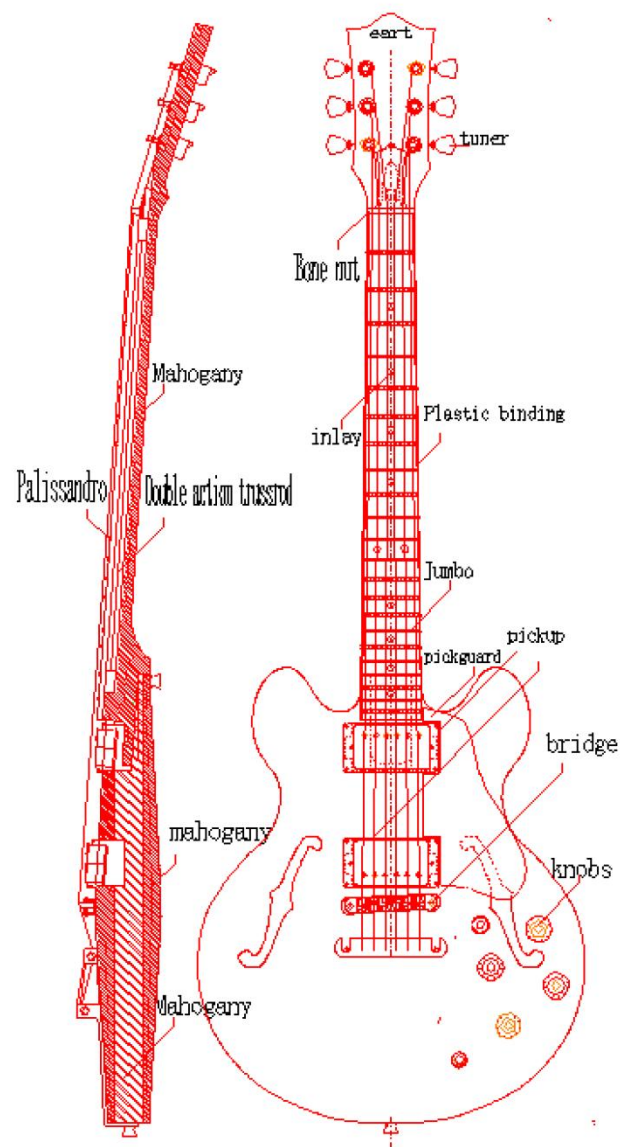

### action

action is the distance between the fret and the strings.

If we want to measure action, we need to set the intonation accurately. Then it is necessary to place the ruler in the 14th fret and measure the distance between the top of the fret and the bottom of the string. Generally speaking, the action of the first fret should be 1.5-1.7mm, and the action of the sixth fret should be 2.0mm--2.2mm.

The method of adjustment is to gradually increase the action from low to high from the first fret. If the action is too high. The guitar will be difficult to play. If the action is too low, phenomena such as punches, silent notes, or lack of sustains may occur. If the action is correct, or if there is still a beating or silent phenomenon, you may need to adjust the neck reinforcement.

### Neck adjustment

The neck is continuously pulled by the strings, and the curvature of the neck is not only affected by the stability of the neck and the thickness of the strings, also changes with temperature and humidity.

If the action and intonation are correctly adjusted, but there is still a case of silent play or note, we need to adjust the curvature of the neck.

1. Check the curvature of the neck. After the intonation is set, press the first string at the first fret and hold the neck at the junction of the body, and then measure the gap between the string and the fret at the eighth fret. The gap of the lowest string is measured in the same way, and then adjusted so that the gap is within 0.3mm-0.5mm.

2. If the clearance is less than 0.3mm, you need to adjust the neck truss rod according to the direction "A" to make the curve of the neck more concave.

3. If the gap is higher than 0.5mm, you need to adjust the neck truss rod according to the direction "B" to make the curvature of the neck more convex.

※ Adjust the reinforcement nut 1/4 turn each time, while checking the tuning results.

### note

The neck must be carefully adjusted. Adjusting with too much force can damage your guitar.

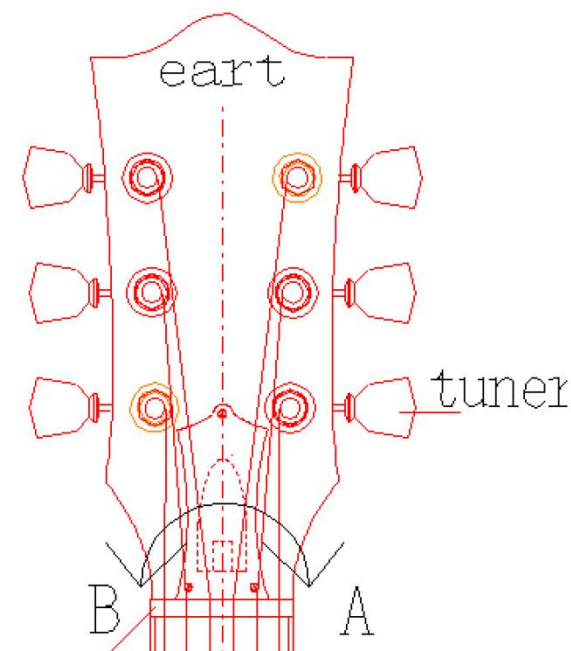

## bridge adjustment

Tune-O-Matic Style Bridge with Stopbar Tailpiece

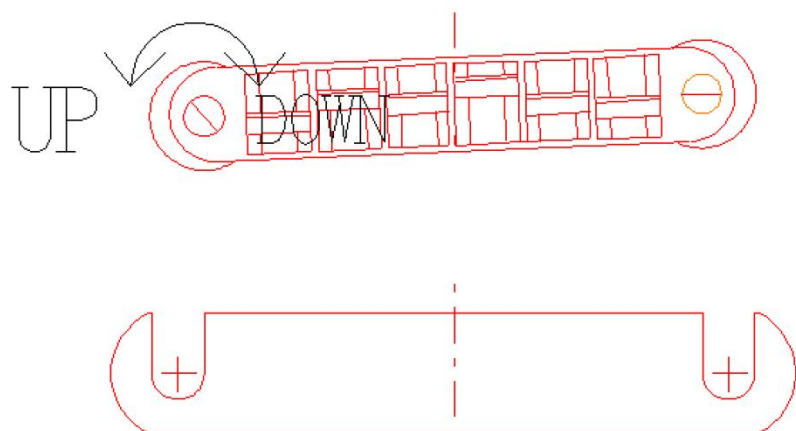

## control

3WAYSWITCHPOSITION			
3	2	1	3WAYSWITCH POSITION
T1	T1&T2	T2	TONECONTROL
			NECKPICKUP
			BRIDGEPICKUP
	PICKUPISON		PICKUPISOFF

## pickups adjustment

pickups	bass side	treble side
vintage style	2.4mm	2mm
standard single-coil	2mm	1.6mm
humbucking	1.6mm	1.6mm

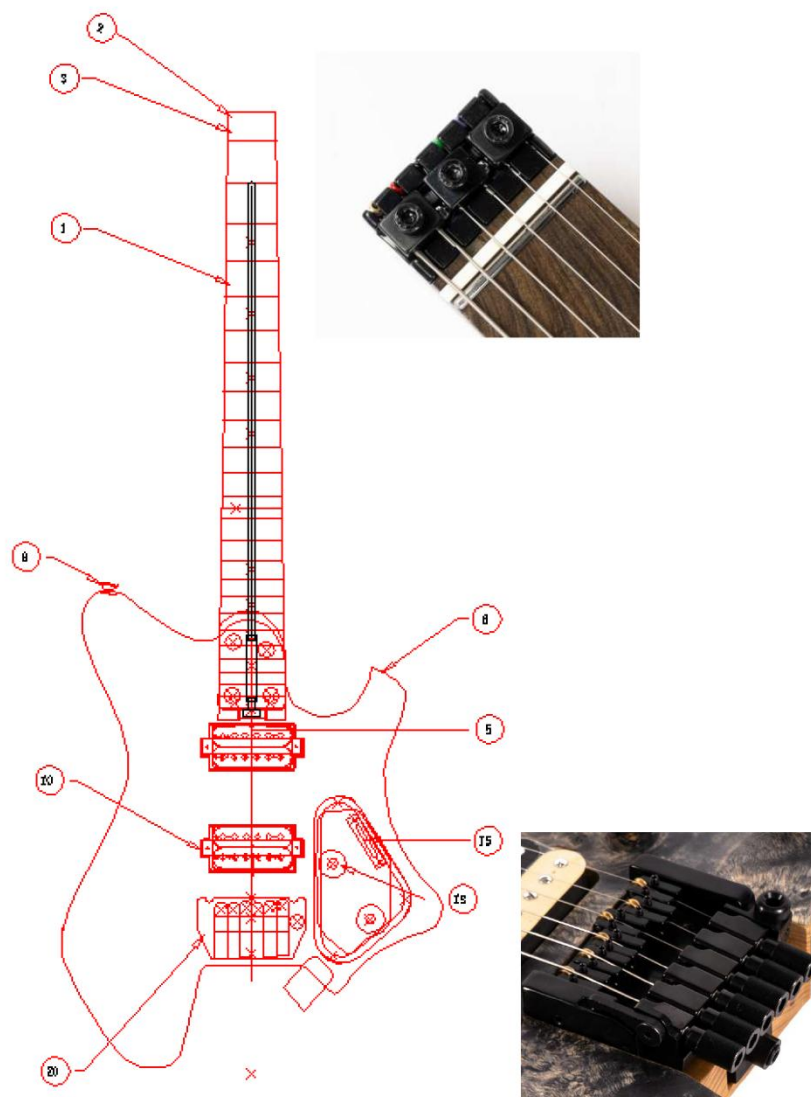

REF #	DESCRIPTION
1	Neck
2	TuningKey
3	BoneNut
5	TrussRodAdjustmentNut
6	Body
8	StrapButton
10	Pickup
13	Knob, Knurled
15	Switch, Lever3-Position
20	Bridge

### action

action is the distance between the fret and the strings.

If we want to measure action, we need to set the intonation accurately. Then it is necessary to place the ruler in the 14th fret and measure the distance between the top of the fret and the bottom of the string. Generally speaking, the action of the first fret should be 1.5-1.7mm, and the action of the sixth fret should be 2.0mm--2.2mm.

The method of adjustment is to gradually increase the action from low to high from the first fret. If the action is too high. The guitar will be difficult to play. If the action is too low, phenomena such as punches, silent notes, or lack of sustains may occur. If the action is correct, or if there is still a beating or silent phenomenon, you may need to adjust the neck reinforcement.

### Neck adjustment

The neck is continuously pulled by the strings, and the curvature of the neck is not only affected by the stability of the neck and the thickness of the strings, also changes with temperature and humidity.

If the action and intonation are correctly adjusted, but there is still a case of silent play or note, we need to adjust the curvature of the neck.

1. Check the curvature of the neck. After the intonation is set, press the first string at the first fret and hold the neck at the junction of the body, and then measure the gap between the string and the fret at the eighth fret. The gap of the lowest string is measured in the same way, and then adjusted so that the gap is within 0.3mm-0.5mm.

2. If the clearance is less than 0.3mm, you need to adjust the neck truss rod according to the direction "A" to make the curve of the neck more concave.

3. If the gap is higher than 0.5mm, you need to adjust the neck truss rod according to the direction "B" to make the curvature of the neck more convex.

※ Adjust the reinforcement nut 1/4 turn each time, while checking the tuning results.

### note

The neck must be carefully adjusted. Adjusting with too much force can damage your guitar.

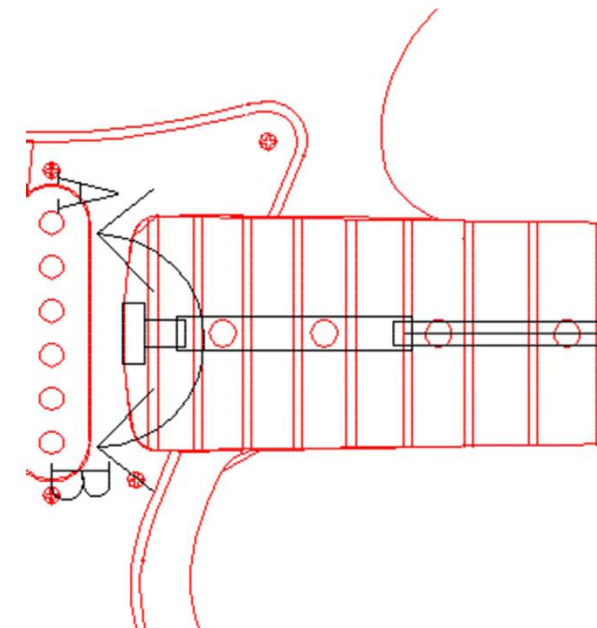



## bridge adjustment



1,put the strings at locking nut first,lock it as photo 1,  
2,there is hole at the roller of each bridge end machines,put in the strings and Turn the tail counterclockwise with a wrench.



1,left allen key can fix all the saddle ,  
2,top allen key can adjust the height of the saddle,  
3,lock at left side of the tremolo ,unlocked can use tremolo, locked can use as fixed  
4,end machines can loose and tight the strings ,use wrench or right allen key all is ok

## control

3WAYSWITCHPOSITION			
			← 3WAYSWITCH POSITION
T1	T1&T2	T2	← TONECONTROL
			← NECKPICKUP
			← BRIDGEPICKUP
	PICKUPISON		
			PICKUPISOFF

## pickups adjustment

pickups	bass side	treble side
vintage style	2.4mm	2mm
standard single-coil	2mm	1.6mm
humbucking	1.6mm	1.6mm

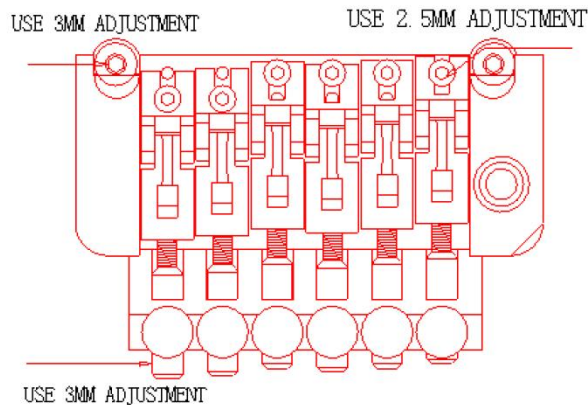
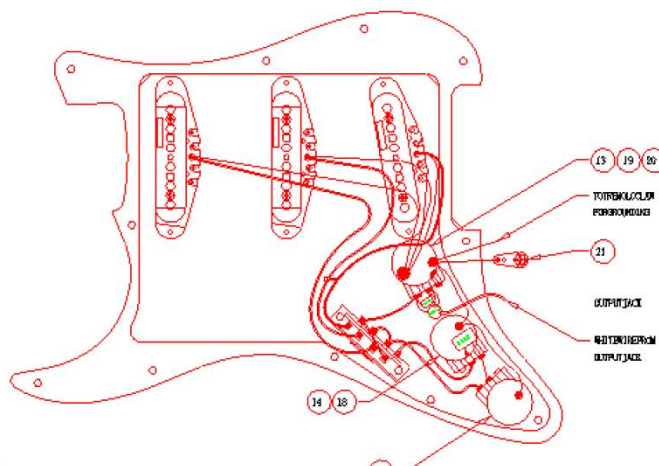
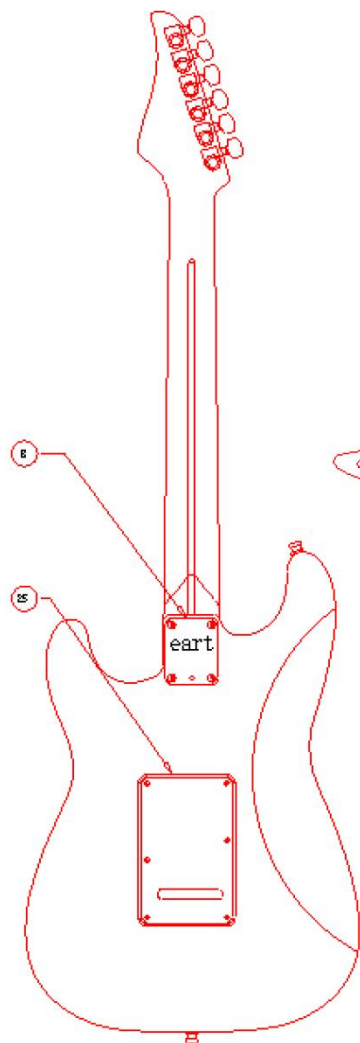
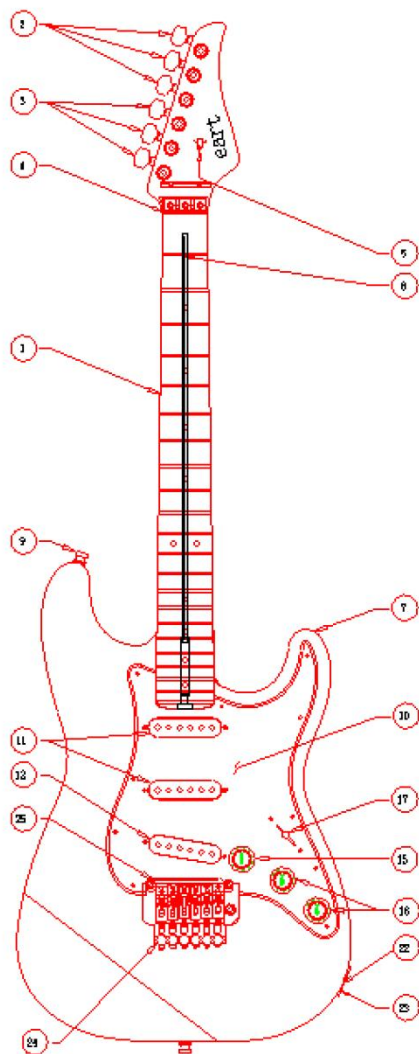

REF. #

DESCRIPTION

1	Neck
2	TuningKey
3	TuningKey
4	BoneNut
5	StringRetainer
6	TrussRodAdjustingWrench
7	Body
8	NeckMountingPlate
9	StrapButton
10	Pickguard
11	Pickup, Neck/Middle.
12	Pickup, Bridge
13	Control
14	Control
15	Knob, Volume
16	Knob, Tone
17	Switch, Lever5-Position
18	Capacitor
19	Capacitor
20	Resistor
21	SolderLug
22	OutputJack
23	Ferrule, Jack
24	BridgeAssembly
25	PivotScrew Insert
26	BackPlate, Tremolo, Aged

### action

action is the distance between the fret and the strings.

If we want to measure action, we need to set the intonation accurately. Then it is necessary to place the ruler in the 14th fret and measure the distance between the top of the fret and the bottom of the string. Generally speaking, the action of the first fret should be 1.5-1.7mm, and the action of the sixth fret should be 2.0mm--2.2mm.

The method of adjustment is to gradually increase the action from low to high from the first fret. If the action is too high. The guitar will be difficult to play. If the action is too low, phenomena such as punches, silent notes, or lack of sustains may occur. If the action is correct, or if there is still a beating or silent phenomenon, you may need to adjust the neck reinforcement.

### Neck adjustment

The neck is continuously pulled by the strings, and the curvature of the neck is not only affected by the stability of the neck and the thickness of the strings, also changes with temperature and humidity.

If the action and intonation are correctly adjusted, but there is still a case of silent play or note, we need to adjust the curvature of the neck.

1. Check the curvature of the neck. After the intonation is set, press the first string at the first fret and hold the neck at the junction of the body, and then measure the gap between the string and the fret at the eighth fret. The gap of the lowest string is measured in the same way, and then adjusted so that the gap is within 0.3mm-0.5mm.

2. If the clearance is less than 0.3mm, you need to adjust the neck truss rod according to the direction "A" to make the curve of the neck more concave.

3. If the gap is higher than 0.5mm, you need to adjust the neck truss rod according to the direction "B" to make the curvature of the neck more convex.

※ Adjust the reinforcement nut 1/4 turn each time, while checking the tuning results.

### note

The neck must be carefully adjusted. Adjusting with too much force can damage your guitar.

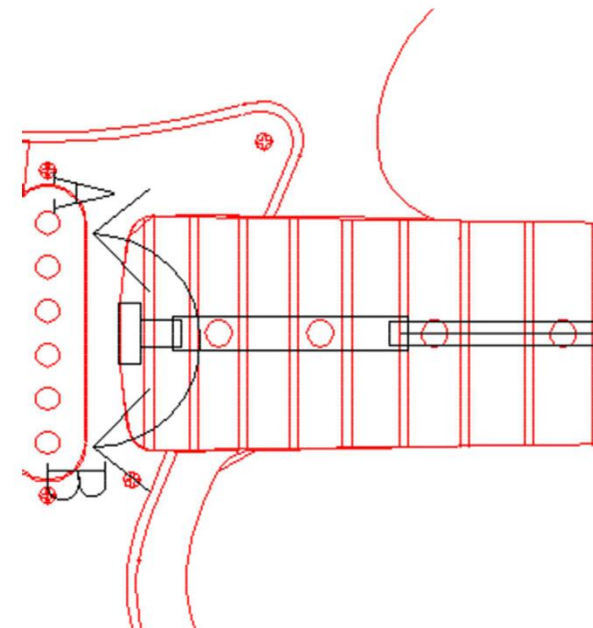

## bridge adjustment

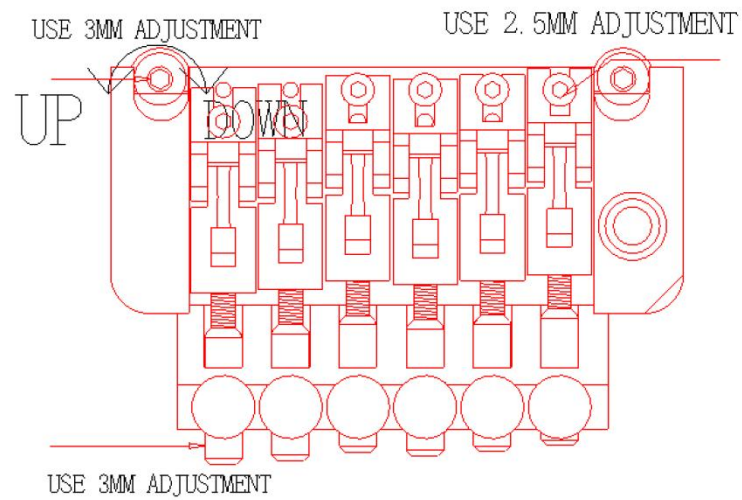

## pickups adjustment

pickups	bass side	treble side
vintage style	2.4mm	2mm
standard single-coil	2mm	1.6mm
humbucking	1.6mm	1.6mm

## control

2 humbuckers, 1 volume, 1 tone, 3 way blade

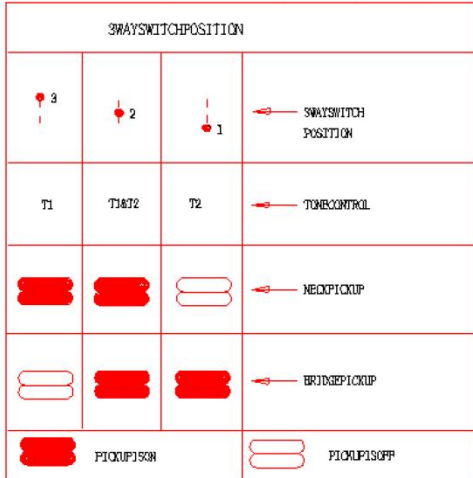

2 single coils, 1 humbucker, 1 volume, 2 tone, 5 way blade

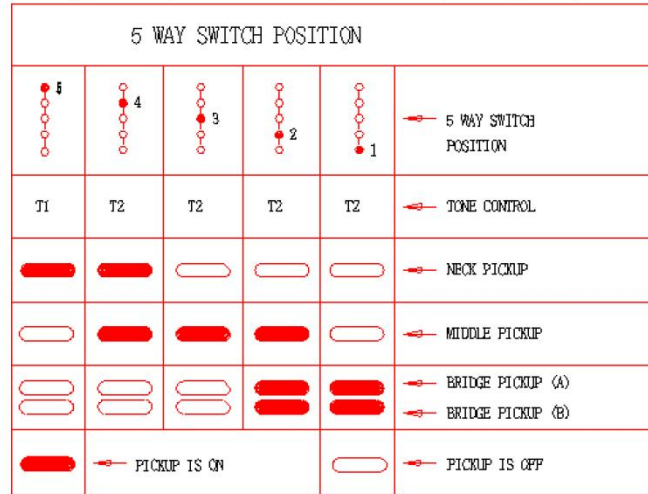

3 single coils, 1 volume, 2 tone, 5 way blade

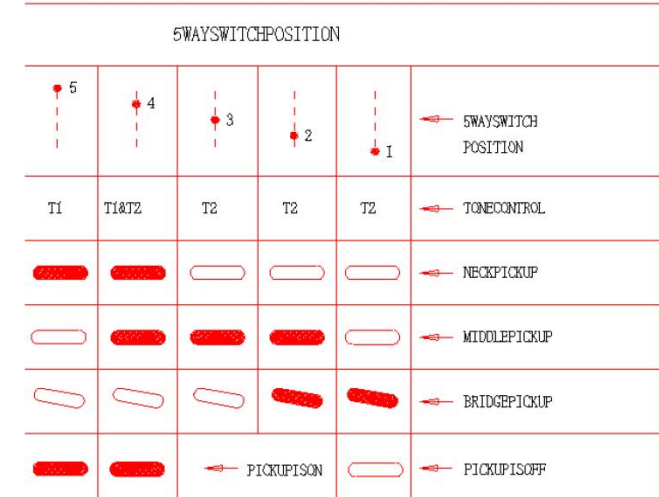

3 single coils, 1 volume, 2 tone (Push-Pull for Bridge Pickup Bypass), 5 way blade

2 single coils, 1 humbucker, 1 volume, Neck Tone (Push-Pull for Pickup Bypass), Middle/Bridge Tone (Push-Pull for Coil Split), 5 Way Blade Switch

