

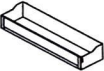







A2 same side: Installation drawing damping side pull basket

Notes :

1. please read the instruction carefully before installation;
2. cabinet width is subject to product ,550mm depth,height≥650mm,cabinet thickness16-18mm

Accessory List

basket	Slide Frame	① Doorconnector	② MSX8	③ M6X10	④ ST4X16	⑤ ST4X16	⑥ wall plug
2 pcs/3pcs	1set	2 set	4 pcs	4 pcs	8 pcs	8 pcs	4 pcs
							
		Have been installed in side frame			In the hardware bag		

STEPS

STEPS 1 :

1. As shown in figure A the size requirements of drilling holes in the side plates, the wall plug into the drilled holes have holes or system;
2. With the Flat Head Phillips Wood Screw, cross the third holes on the Slide, screw into the wall plug and fix it on the side board
3. With the same installation method, another slide

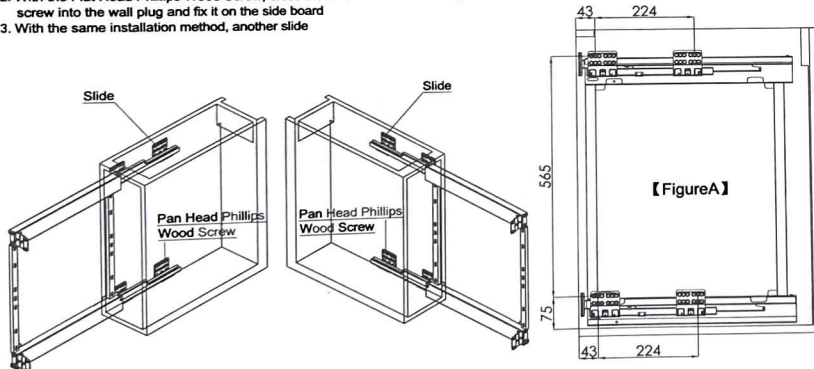

STEPS 2:

1. According to the hole position of door panel in the form, locate and install the door connector as shown in figure B
2. With fixed plate mounted on the panel with the Pan Head Phillips Wood Screw through the door
3. Loosen the screws slightly and adjust the door closure

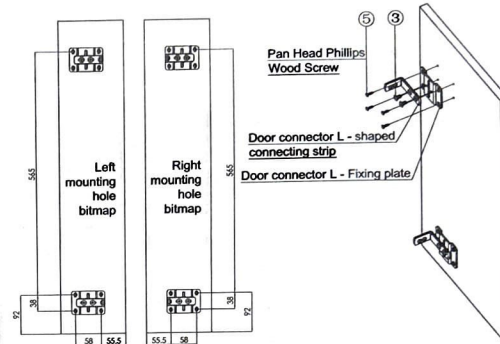

【FigureB】

Shown in the drawing of the side loading basket, right and left: the left and right are symmetrically installed, and the door closing amplitude is adjusted by the screw of the door adjuster

STEPS 3:

1. Hanging on the frame in parallel with the basket body, and adjusting the distance between the basket and the basket according to the use condition;

