

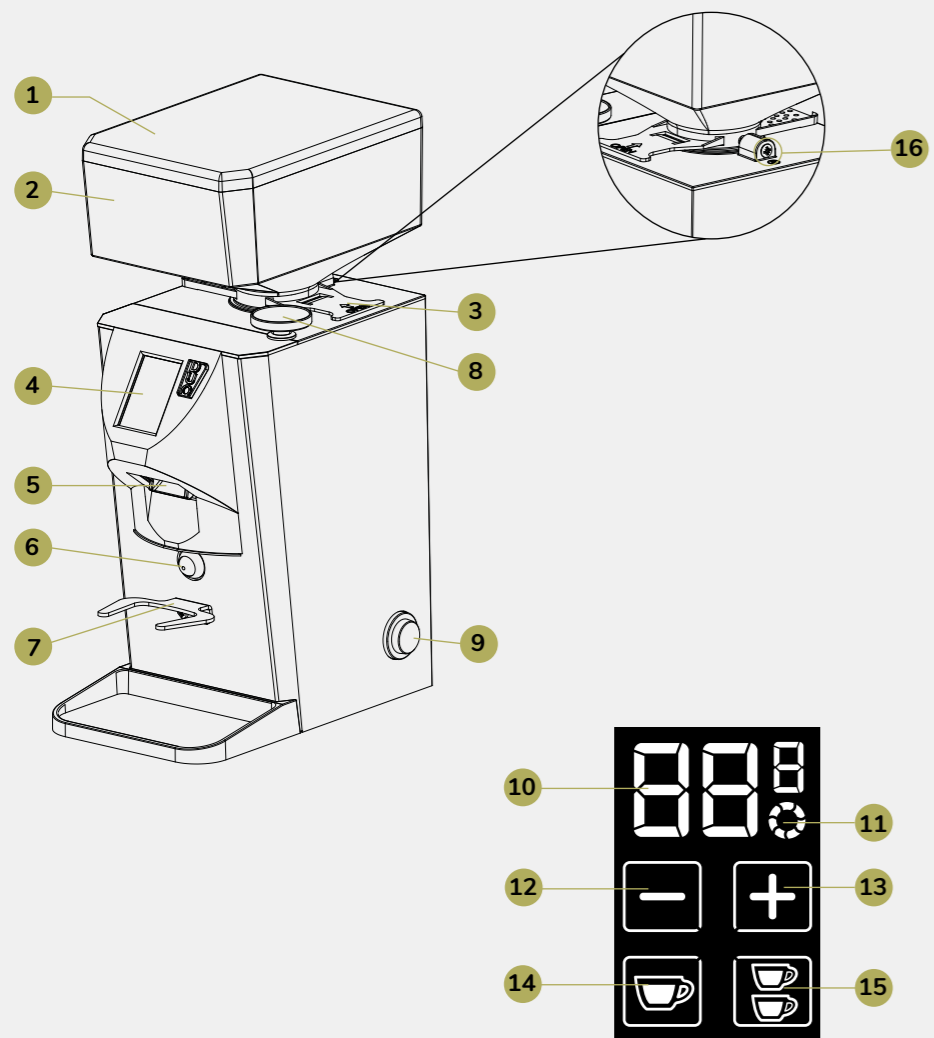

*quick guide*

## 1. DESCRIPTION OF THE PRODUCT



- 1 HOPPER LID
- 2 COFFEE BEAN HOPPER
- 3 COFFEE BEAN HOPPER OPEN/CLOSE TAB
- 4 DISPLAY TOUCHSCREEN
- 5 DISPENSER
- 6 FRONT GRIND START BUTTON
- 7 PORTAFILTER FORK
- 8 GRIND REGULATION KNOB
- 9 ON SWITCH
- 10 DISPENSING TIME/DOSE COUNTER DISPLAY
- 11 ACTIVE CONTINUOUS DISPENSER
- 12 DECREASE BUTTON
- 13 INCREASE BUTTON
- 14 SINGLE DOSE BUTTON
- 15 DOUBLE DOSE BUTTON
- 16 COFFEE BEAN CONTAINER SCREWS

## 2. USING THE GRINDER/DISPENSER

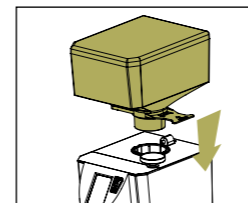

Before switching on the grinder/dispenser, insert the hopper into its holder by positioning the hole in line with the screw at the back of the device.

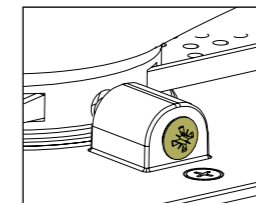

Tighten the lock screw.

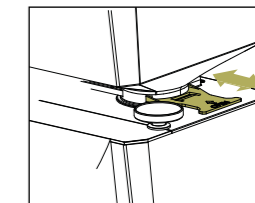

Push the tab (3) to close the container (2).

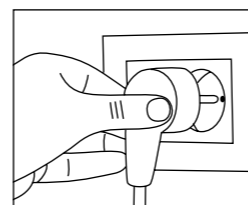

Unplug the coffee grinder.

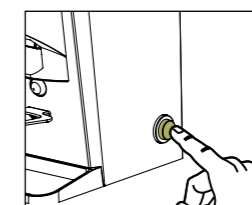

Press the on switch.

## 3. DISPENSING AND REGULATION OF DOSES (DISPLAY)



Select the dose to be dispensed by pressing the single dose (14) or double dose (15) button (the selected dose button lights up).

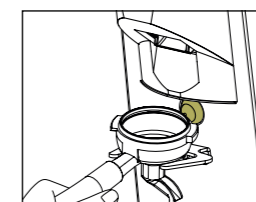

To start dispensing, place the portafilter onto the fork and apply slight pressure on the start grind button (6). Grinding time is visible on the display.

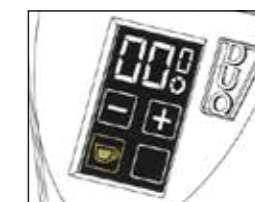

Once dispensing is completed, the grinding time returns to its pre-set value.

## 4. CONTINUOUS DISPENSING

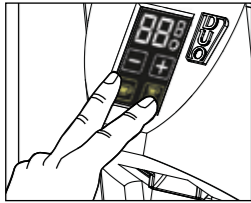

Press both the single dose (14) and the double dose (15) buttons. The symbol (11) will appear on the display.



Continuous dispensing lasts for a maximum of 60 seconds.

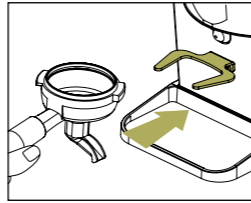

Place the portafilter on the fork (7).

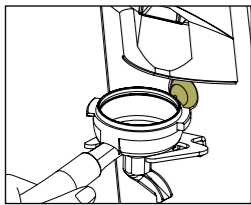

Press the portafilter until it comes into contact with the front start button (6) to dispense ground coffee from the spout (5).

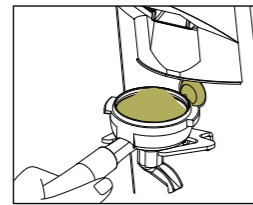

Press the front button (6) to stop dispensing and remove the portafilter.

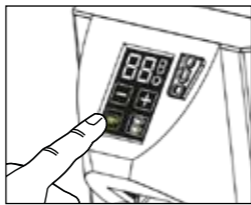

To exit from continuous dispensing mode, press the single dose (14) or double dose (15) button.

## 5. REGULATING THE GRIND

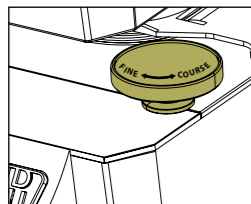

Rotate the regulation knob (8) clockwise for a finer grind or anticlockwise to increase the granulometry.

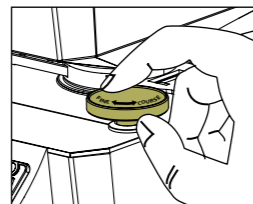

Carry out regulation gradually by grinding a little coffee every two notches at most.

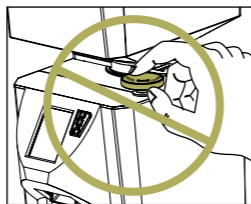

Do not rotate the knob when the motor is idle because the machine may jam.

## 6. HOW TO CLEAN THE HOPPER (once a week)

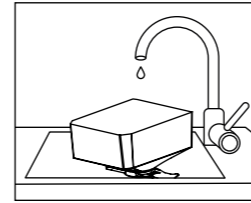



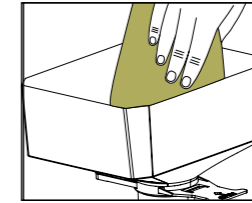





Wash the inside of the hopper with water and neutral soap.



Thoroughly rinse and dry it.

## 7. Q&A

	POSSIBLE CAUSES	SOLUTION	OUTCOME	
<b>The machine is not grinding coffee</b>	a) No electricity supply.	Check that the plug is working correctly, then make sure that the switch is in the ON position (“I” symbol).		
	b) The coffee beans are not reaching the burrs.	Open the tab of the coffee bean container, then with the motor on rotate the grind regulation knob towards “COARSE” (anticlockwise at least half a turn).		
	c) The burrs are jammed.	Contact the technical service centre.		
<b>The ground coffee is not coming out of the front spout</b>	a) The spout is blocked (there is a sound of the motor running but the burrs are not moving and coffee is not being dispensed).	Contact the technical service centre.		
<b>The quantity of ground coffee is limited.</b>	a) Grinding time is too short.	Increase the coffee grinding time by using the “+” button on the display.		

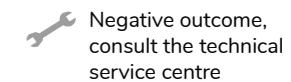
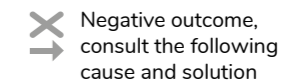



### ITALY

Simonelli Group  
Via E. Betti, 1  
62020 Belforte del Chienti  
Macerata - Italy  
T +39 0733 9501  
info@simonelligroup.it  
www.simonelligroup.it

### SINGAPORE

Simonelli Group Asia Pacific Pte Ltd  
380 Jalan Besar  
#06-03-04, ARC 380,  
Singapore 209000  
T +65 68410985  
www.nuovasimonelliasiapacific.com

### USA

Nuova Distribution USA  
6940 Salashan Pkwy, Bldg, A  
Ferndale, WA 98248  
T +1 360 366 2226  
info@simonelliusa.com  
www.simonelliusa.com



### FRANCE

Nuova Distribution France  
Hexapole- Actipole - Bat 5  
Rue Maurice Herzog  
73420 Viviers Du Lac  
T +33 [0] 9 67894852  
info@nuovadistribution.fr

---

[www.nuovasimonelli.com](http://www.nuovasimonelli.com)

Follow us

-  @ nuovasimonelliofficial
-  @ nuovasimonelliofficial
-  NuovaSimonelli