

iZEEKER

Quick Start Guide

DASH CAM

GD100

EN

DE

ES

Check User Manual

- Scan the QR code to check or download the GD100 User Manual.
- Scannen Sie den QR-Code, um das GD100-Benutzerhandbuch zu prüfen oder herunterzuladen.
- Escanea el código QR para consultar o descargar el Manual de Usuario del GD100.

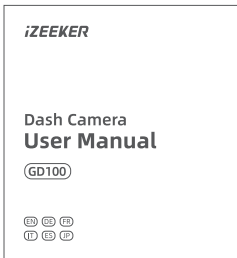

iZEEKER Dash Cam Video

- Search "iZEEKER Dash Cam" YouTube Channel or scan the QR code.
- Durchsuchen Sie den YouTube-Kanal „iZEEKER Dash Cam“ oder scannen Sie den QR-Code.
- Escanea el código QR para consultar o descargar el Manual de Usuario del GD100.

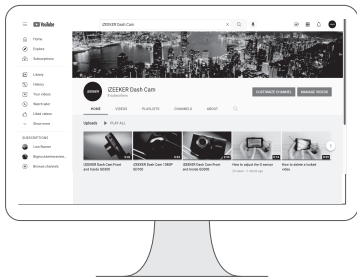

Customer Service

Any questions or doubts contact us at support@izeeker.co

Any feedback or suggestions contact us at complaint@izeeker.co

Installation

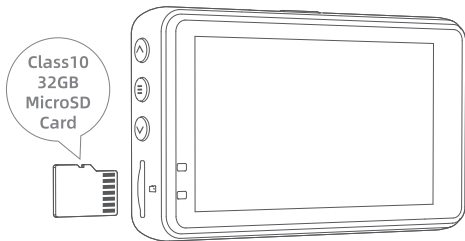

- Insert the MicroSD card with your fingernail, and format SD card before use.
- Legen Sie die MicroSD-Karte mit Ihrem Fingernagel ein und formatieren Sie die SD-Karte vor der Verwendung.
- Inserte la tarjeta MicroSD con la uña y formatee la tarjeta SD antes de usarla.

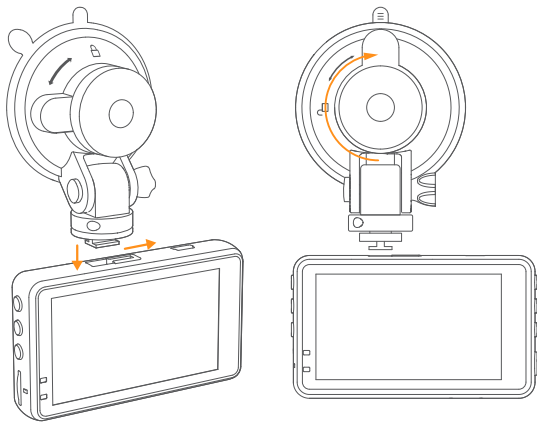

- Connect the dash camera to the suction mount.
- Schließen Sie die Strichkamera korrekt an die Saughalterung an.
- Conecte la dashcam a la ventosa.



Made in China
Version 1.2

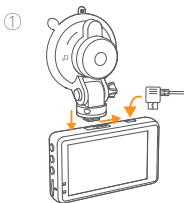
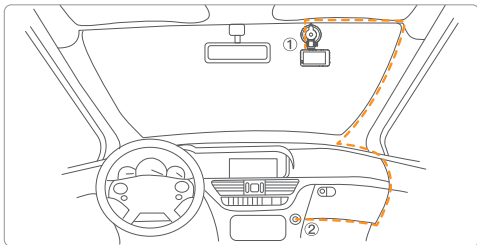

- Use the car charger to connect the camera to the cigarette lighter socket.
- Verwenden Sie das Autoladegerät, um die Kamera an den Zigarettanzünderanschluss anzuschließen.
- Utilice el cargador de coche para conectar la cámara a la toma del encendedor de cigarrillos.

Recording

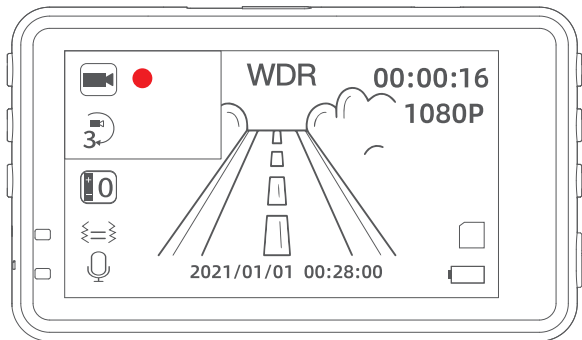

- Upon starting the ignition, the camera automatically starts recording.
- Beim Starten der Zündung beginnt die Kamera automatisch mit der Aufnahme.
- Al iniciar el encendido, la cámara comienza a grabar automáticamente.

Emergency Recording

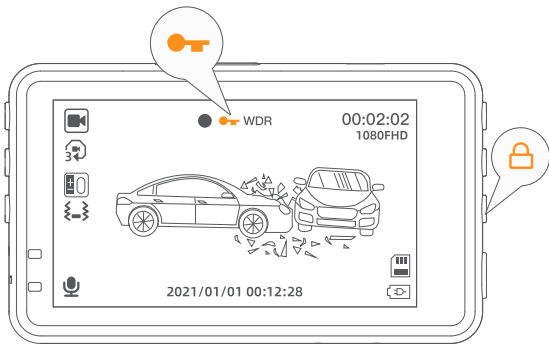

- The G-sensor detects collisions and locks the footage automatically as evidence, lock button can lock video manually.
- Der G-Sensor erkennt Kollisionen und sperrt das Filmmaterial automatisch als Beweis, die Sperrtaste kann das Video manuell sperren.
- El sensor G detecta colisiones y bloquea el metraje automáticamente como evidencia, el botón de bloqueo puede bloquear el video manualmente.

24/7 Parking Monitoring

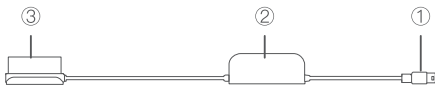
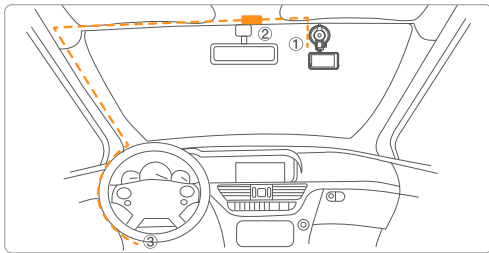

Not included

Mini hardware kit

- For 24/7 parking monitoring, install a mini hardware kit with the dash cam.
- Für die 24/7-Parkplatzüberwachung installieren Sie die Armaturenbrettkamera mit einem Mini Hardware-Kit.
- Para monitorear el estacionamiento las 24 horas, instale un mini kit de cableado con la dashcam.

Enter Menu

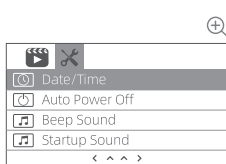
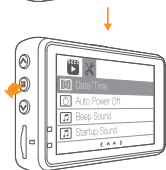
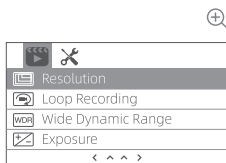
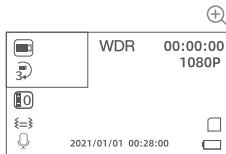

- Press the Menu Button to enter the Settings.
- Drücken Sie die Menütaste, um die Einstellungen einzugeben.
- Presione el botón Menú para ingresar a la Configuración.

Playback on Camera & PC

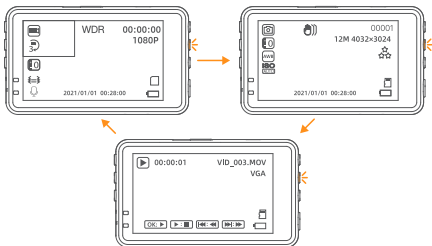

- Press the M button once to enter Camera Mode and twice to enter Playback Mode.
- Drücken Sie die M-Taste einmal, um den Kameramodus aufzurufen, und zweimal, um in den Wiedergabemodus zu gelangen.
- Presione el botón M una vez para ingresar al modo de cámara y dos veces para ingresar al modo de reproducción.

iZEEKER

Quick Start Guide
DASH CAM

GD100

EN DE ES

Made in China
Version 1.2



本设计图纸版权归本公司所有，未经本公司书面同意不得复印。

本图纸应与说明，产品状况，产品结构图及有
关图纸协调使用，发现任何差异请立即通知设计师。

图档中所有尺寸比例为1:1。

公差: L(长)*W(宽): +1/-1mm,H(高): ±1mm

项目信息

立项时间:	
计划时间:	
品牌:	iZEEKER
型号:	GD100
类型:	快速指南
版本号:	V1.2
版本变更描述:	

切刀 
压线 
开槽 
半穿 
粘合 

尺寸: 成品92×100mm (风琴折页)

印刷颜色: CMYK

材质: 128g双胶纸

特种工艺:

备注:

设计审核

1. 设计师:		2. 销售确认:	
3. 设计经理审核:		4. 项目经理确认:	
5. 品牌总监审核:		日期:	