



**Comfort
Bilt**

***Building Quality
Comforts***



OWNER'S MANUAL

HP22 PELLET STOVE

⚠ WARNING!

Please read this entire manual before installation and use of this fuel-burning pellet room heater, and save for future reference. Failure to follow these instructions could result in property damage, bodily injury, or even death. Contact local building or fire officials about restrictions and installation inspection requirements in your area.



Safety Alert Key: It is important to pay attention to alerts you will see throughout this manual to ensure your safety.

- **DANGER!** Indicates a hazardous situation which, if not avoided, will result in death or serious injury.
- **WARNING!** Indicates a hazardous situation which, if not avoided, could result in death or serious injury.
- **CAUTION!** Indicates a hazardous situation which, if not avoided, could result in minor or moderate injury.
- **NOTICE:** Indicates practices which may cause damage to the stove or to property.
- **Pro Tip:** Indicates additional information to help you better understand your stove and optimize its performance.

This wood heater needs periodic inspection and repair for proper operation.

It is against federal regulations to operate this wood heater in a manner inconsistent with operating instructions in this manual.

NOTICE: FIRE RISK

SMG Hearth and Home / ComfortBilt disclaims any responsibility, and the warranty and agency listing will be voided by the below actions.



DO NOT:

- Install or operate damaged stove.
- Modify Stove.
- Install other than as instructed by the manufacturer.
- Operate the stove without fully assembling all components.
- Over Fire (burning at higher temperatures than recommended, causing permanent damage to the stove.)
- Install any components not approved by the manufacturer.
- Install parts or components not listed or approved.
- Disable safety switches.

⚠️ DANGER! HOT SURFACES

Glass and other surfaces are hot during operation and cool down.

Hot glass will cause burns.



- Do not touch glass until it is cooled.
- NEVER allow children to touch glass or door.
- Keep children away; if you expect that children may come into contact with the stove, we recommend a barrier such as a decorative screen.
- CAREFULLY SUPERVISE children in the same room as the stove.
- Alert children and adults to hazards of high temperatures.

High temperatures may ignite clothing or other flammable materials.

- Keep clothing, furniture, draperies, and other flammable materials away.

⚠️ WARNING!

This product, and the fuels used to operate is (wood), and the products of combustion of such fuels, can expose you to chemicals including carbon black, which is known to the State of California to cause cancer, and carbon monoxide, which is known to the State of California to cause birth defects and other reproductive harm.

For more information go to www.P65warnings.ca.gov



⚠ CAUTION!

- This stove should NOT be used as the **only** source of heat in the home. Power outages and periodic maintenance will result in a total loss of heat.
- Contact local building or fire officials regarding restrictions and installation inspection requirements for your area.
- Contact your local authority (Municipal building department, Fire department, Fire prevention bureau, etc...) to determine the need for a permit.
- Keep combustible materials (such as grass, leaves, etc...) at least 3 feet away from the flue outlet on the outside of the building.
- Installation and repair of this pellet stove should be done by a qualified service person. The appliance should be inspected before use, and at least annually by a qualified service person. It is imperative that the control compartments, fire box, and circulating air passageways of the stove be kept clean.



⚠ CAUTION!

Install at least one smoke detector on each floor of your home to ensure your safety. They should be located away from the stove, and close to the sleeping areas.
You should have separate CO monitors for areas near the stove

NOTICE!

- During a power outage, the stove will shut down safely. Do not open the main door or ash pan door. During a power failure, the exhaust fan will not run. Keeping the doors sealed will allow the exhaust vent to draft out naturally. When the power is restored, the stove will not restart. If the exhaust temperature is still 126° F (52° C) when power is restored, the exhaust and convection fans will continue to run until the stove cools.
- *Over Fire Protection:* If the stove is being over fired or burning too hot, the high limit switches will automatically shut down the stove to avoid damage to other components. If the temperature on the hopper reaches 197° F (92° C), the auger will automatically stop and the stove will shut down. The exhaust fan will continue to run until the proof of fire switch cools. Allow the stove to cool before attempting to re-ignite.



⚠ WARNING!

- If the electrical power fails at any time when the stove is hot, keep all stove doors closed. This will limit the amount of smoke in the space.
- Never shut the stove down (while running) by unplugging it from the power source.
- Never shut the stove down (while running) by switching off the main power switch on the rear of the stove.

This stove has a manufacturer set minimum low burn rate that must not be altered. It is against federal regulations to alter this setting or otherwise operate this stove in a manner inconsistent with the operating instructions within this manual. If the unit is modified, it will no longer be compliant with the EPA regulations.

TABLE OF CONTENTS



STAY SAFE	3
• Safety Key	
• Additional Warnings	
GETTING STARTED	6
• Getting Familiar with Your Stove	
• What's Included	
INSTALLATION	8
• Pre-Installation	
• Floor Protection	
• Clearances to Combustibles	
• Vent Termination Clearances	
• Venting	
• Installation Examples	
OPERATION	16
• Fuel Guide	
• Getting Ready	
• Control Panel Operation	
• Control Panel Display	
• Pre-Ignition Checklist	
• Operational Modes	
• Remote Control	
• Starting Your Stove	
• Settings	
MAINTENANCE	28
• Maintenance & Cleaning Video	
• Side Panel Access	
TROUBLESHOOTING	31
• Troubleshooting Video	
• Total Power Loss	
• Low Temperature Alert	
• High Temperature Alert	
• Failure to Ignite	
• Lazy Burn / Pellet Buildup	
CERTIFICATIONS	34
• BTU & Efficiency Specifications	
• Electrical Rating	
• Glass Specifications	
• Warranty Coverage and Limitations	
WIRING DIAGRAM	36
REPLACEMENT PARTS	37

GETTING STARTED



Getting Familiar with your Stove

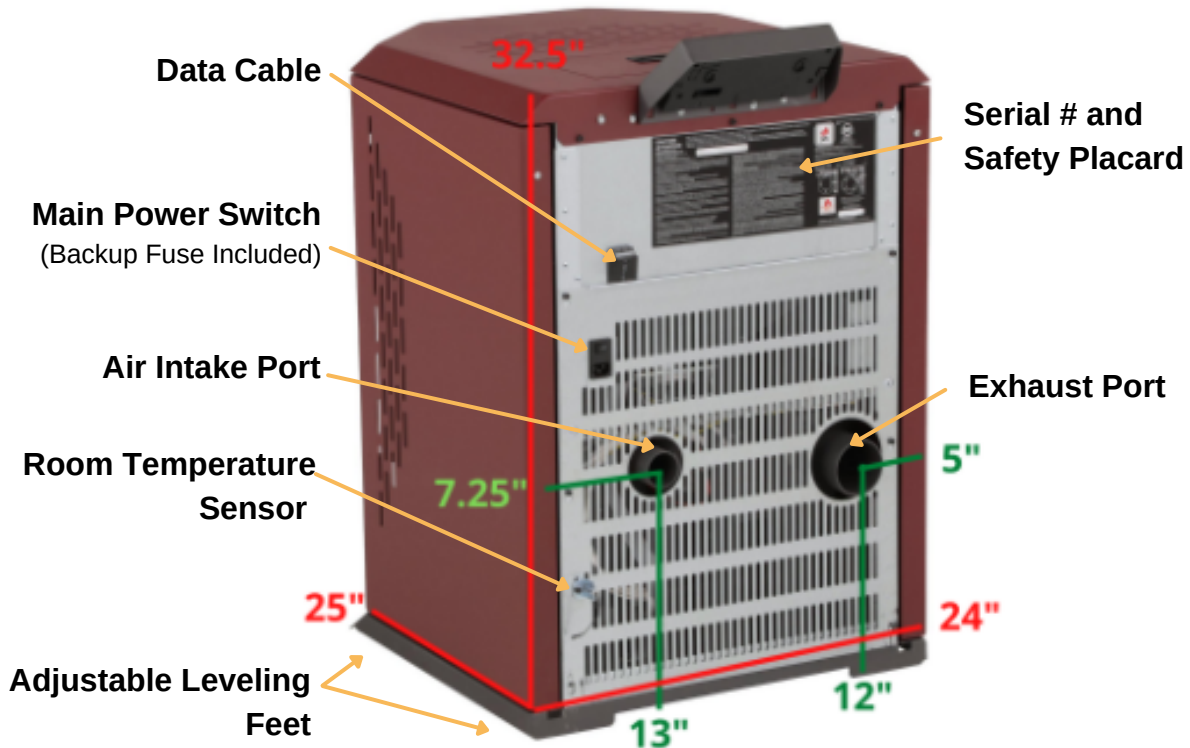
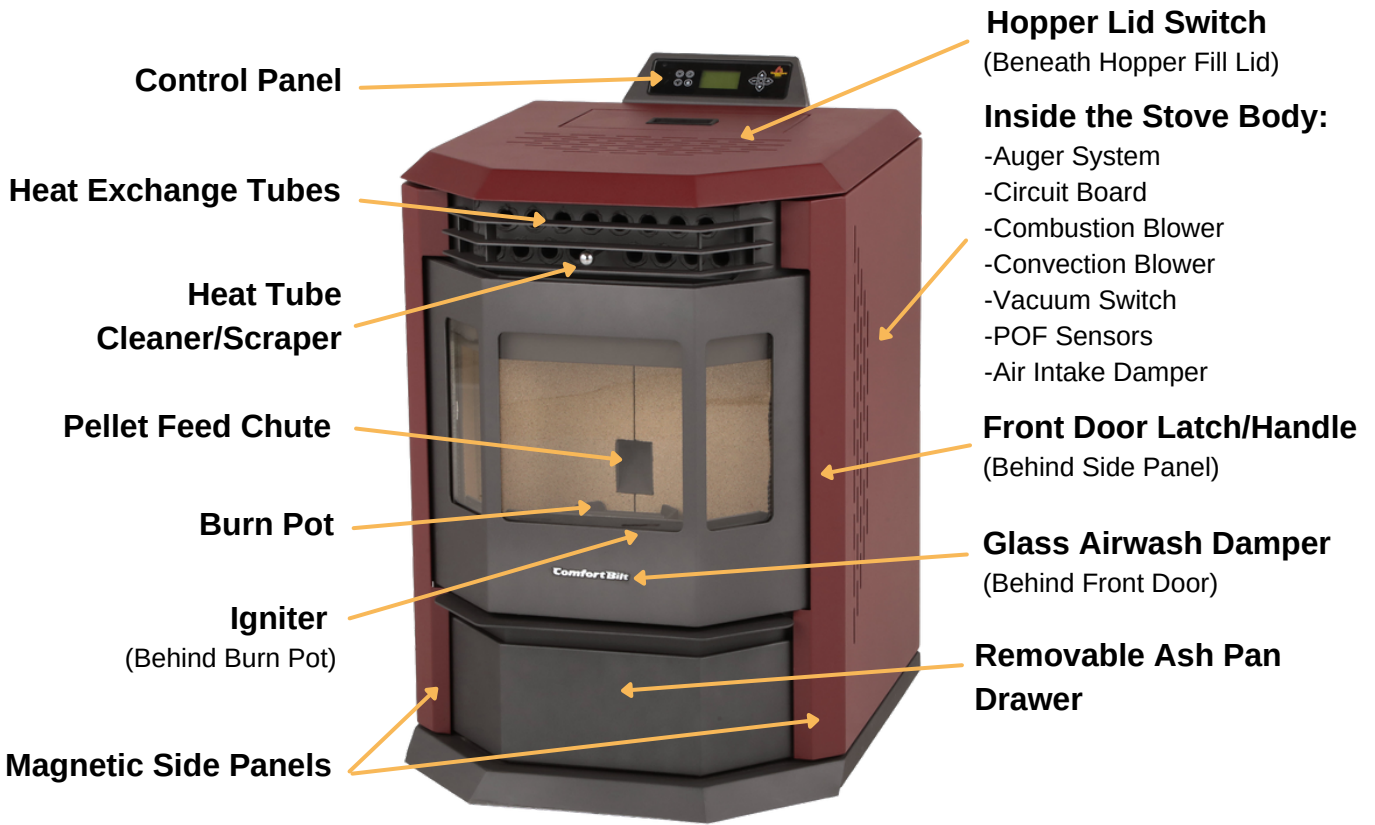

GETTING STARTED

What's Included



Owner's Manual



1 Year Warranty



Online Guides and Videos



Remote Control



Power Cord



Data Cable



Control Panel & Bracket



⚠️ WARNING!

Inspect stove and components for damage. Damaged parts may impair safe operation.

- Do **NOT** install damaged, incomplete, or substitute components.

Report damaged parts to dealer or manufacturer.

⚠️ CAUTION!

- Risk of cuts, abrasions, or flying debris.
- Wear protective gloves and safety glasses during installation.
- Metal edges may be sharp.



⚠️ WARNING! Fire Risk:

NO OTHER vent component may be used. Substitute or damaged vent components may impair safe operation.

What You May Need

Tools & Supplies

- High temperature silicone (500°F+)
- Screwdriver
- Allen wrench set
- Tape measure
- Framing square
- Reciprocating saw
- Electric drill & bits
- Caulking gun
- Level
- Plumb Line
- Stud Finder
- Utility knife
- Pliers
- Flashlight
- Hammer

Safety Equipment *(Recommended for all installation and maintenance steps)*

- Gloves
- Safety glasses
- Close-toed shoes

Pellet Vent Pipe

Must be an approved 3" or 4" diameter Type "L" or "PL" vent. Use 4" diameter vent if flue height is over 12 ft. or if installation is over 5,000ft above sea level. (See *Equivalent Vent Length chart on Pg. 13*)



New Stove Tutorial Playlist

See our New Stove Tutorial Series on YouTube.
Or scan the code.





Pre-Installation

Unpacking:

- Remove cardboard lid, outer box sleeve, and packing foam.
- Inspect for any shipping damage. *(Preferably before delivery team leaves)*
- Unscrew the mounting L brackets that secure the rear of the stove to the pallet. *(4mm Allen)*
- Open hopper lid and remove control panel, power cord, remote control, and all literature and packing material from the hopper.
- Open the front door via the latch on the right side behind the magnetic side panel *(see picture)* and remove cardboard packing material from the firebox chamber.
- Remove any tape or adhesive on the outside of the glass.



Front Door Latch

Mounting the Control Panel:

1. Remove all four Phillips mounting screws along the top rear of the stove where you wish to mount the controller bracket.
2. Line up the holes in the back to the mounting bracket and secure in place. *(Note: Universal mounting brackets are used, so only the far left and two right screws align. This is normal, and will still secure the panel to the stove)*
3. Find the data cable line at the rear of the stove, and plug it snugly into the back of the control panel.
 - The universal mounting bracket will also allow for the control panel to be mounted to the side farthest from the exhaust port for specific vertical venting scenarios. *(The two left and the far right screws are used in this case).*



Control Panel Mounting



Data Wire Connection

Placement:

Where you place your stove can significantly affect its performance and safety.

Sketch out a plan for installing the stove, including dimensions, before permanent placement. When determining the location for the stove, wall stud location is critical. You may need to adjust the location of the stove to avoid encountering a wall stud. Before placing the pellet stove, connect the vent to allow for minimum clearances to combustible walls.



Side Mounting

Pro Tip: It is recommended that your pellet vent pipe be installed and serviced by a professional installer.

- Installation **MUST** comply with local, regional, state and national codes and regulations.
- Consult insurance carrier, local building inspector, fire officials, or authorities having jurisdiction over restrictions, installation inspection and permits.

Surge Protector

Protect the electrical components of your stove by using a surge protector.

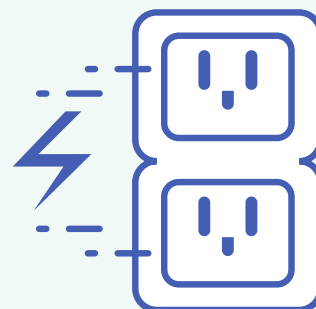

⚠️ WARNING!

Asphyxiation Risk:
DO NOT INSTALL IN A SLEEPING ROOM.
Stove consumes oxygen in the room.

INSTALLATION



Floor Protection

Floor Protection

Non-combustible material (such as a hearth pad) is required underneath your stove.



The stove must be installed on a noncombustible floor, with proper floor protection, or on a masonry hearth. When a clean out T-vent is installed on the inside of a home, the floor protector must extend 2 inches beyond the rear of the T-vent.

When stove is vented straight through the wall and the clean out T-vent is on the exterior of the home, the minimum clearance is 2 inches from the back of the stove to the wall.

- It is necessary to install Ember Protection: a type 1 floor protector for this stove.
- The floor protector must be non-combustible material, extending beneath the stove with a minimum of 6 inches (152mm) in front of the glass, and 6 inches (152mm) to both sides of the stove.
- Non-combustible floor protection must extend 2 inches (51mm) beneath the flue pipe of installed horizontal venting or under the top vent adapter with vertical installation. CANADA REQUIRED, USA RECOMMENDED.

Notice: Be careful to protect the bottom of the stove and floor surfaces when moving the stove. Bottom edges of the stove may be sharp and can scratch surfaces.

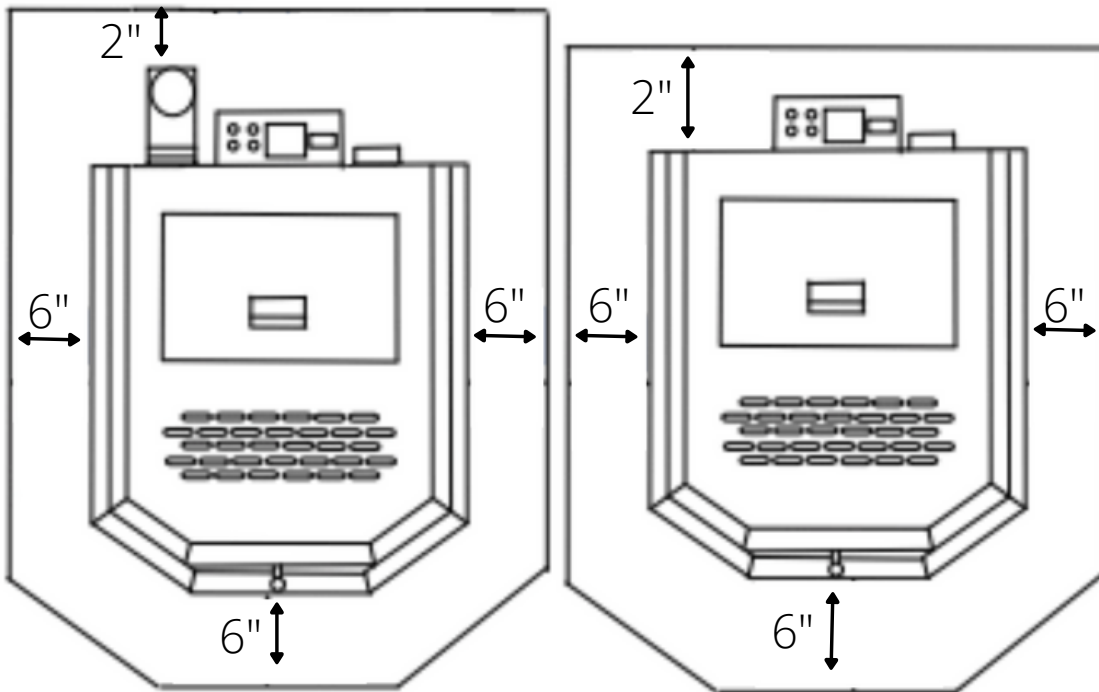

*This will satisfy safety standards for both USA and Canada

Notice: Clearances may only be reduced by means approved by the regulatory authority having jurisdiction.



Clearances to Combustibles

- Confirm required clearances to combustibles (Combustibles include wood, drywall, etc...)

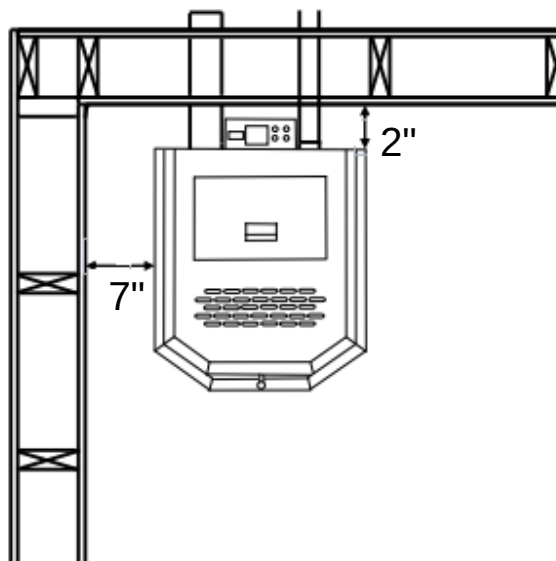
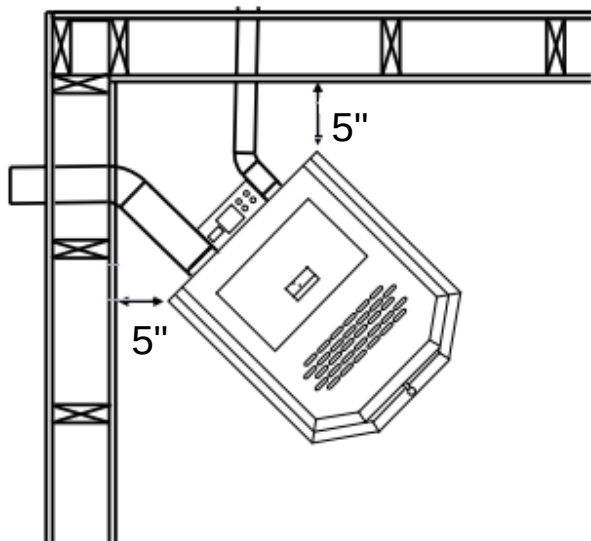

Horizontal installation

- Back walls to Stove rear corners: **5" (13cm)**
- Back wall to Stove back: **2" (5cm)**
- Side wall to Stove: **7" (18cm)**

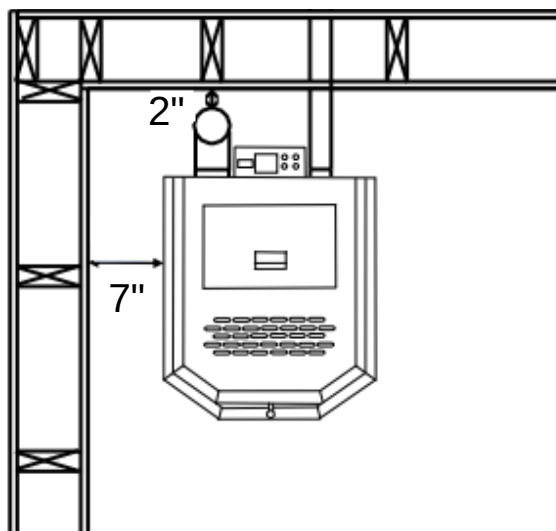
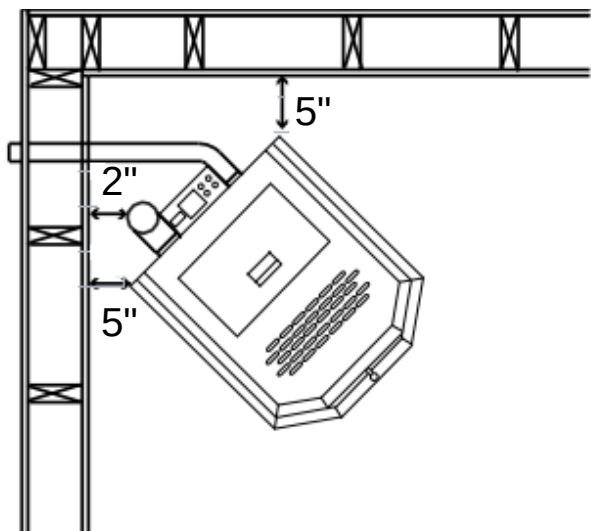

Vertical installation

- Back walls to Stove rear corners: **5" (13cm)**
- Back wall to pellet pipe: **2" (5cm)**
- Side wall to pellet pipe: **2" (5cm)**
- Side wall to Stove: **7" (18cm)**

Notice: When interior vent is installed vertically, the clearance to the back wall is determined by the vent size used. Install vent at clearance specified by the vent manufacturer. Take into consideration any upward turning elbows or tees.



CAUTION!

Take appropriate precautions to locate utilities within the wall and avoid contact.



Vent Termination Clearances

The stove vent must terminate on the outside of the building. Horizontal terminations must extend a minimum of 12" from the wall. Vertical terminations must protrude a minimum of 24" from the roof surface.

In addition, all clearances listed below must be met.

- Must have an approved cap (to prevent water from entering) or a 45 degree downturn with rodent screen.
- If the termination is located on a windy side of the house, we suggest using an approved house shield to prevent soot from building up on the side of the house.
- A vent must not be located where it may become plugged by snow or other material.

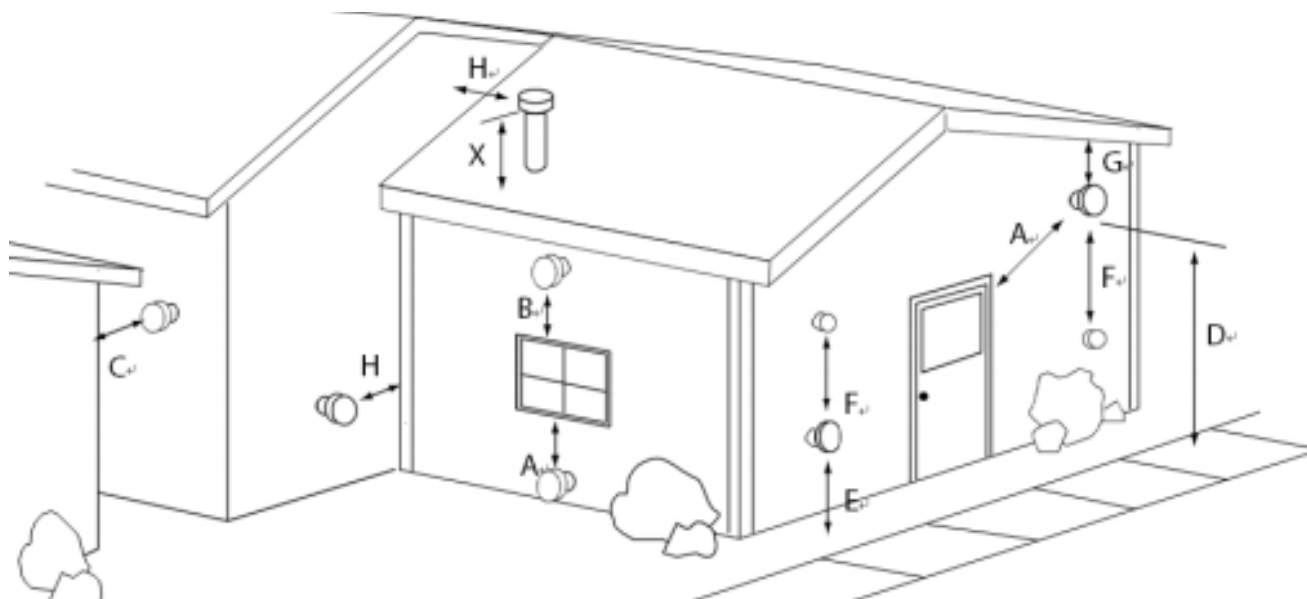

A: Minimum 48" clearance below or beside any door or window that opens. (This clearance may be reduced to 18" if using outside air). We recommend the door or window be kept closed during operation. Minimum 12" clearance below or beside any window that does not open.

B: Minimum 12" clearance above any door or window that opens.

C: Minimum 24" clearance from any adjacent building.

D: Minimum 7' clearance above any grade, when adjacent to public walkways.

E: Minimum 24" clearance above any grass, plants, or other combustible materials.

F: Minimum 36" clearance from any forced air intake of another appliance.

G: Minimum 24" clearance below eaves or overhangs.

H: Minimum 12" clearance horizontally from combustible wall.

X: Must be a minimum of 24" above the roof.

NOTICE:

Do NOT terminate vent:

- In any location that will allow flue gasses or soot to enter or stain the building.
- In any location which could create a nuisance or hazard.
- In any enclosed or semi enclosed area such as a carport, garage, attic, crawl space, under a sun deck or porch, or narrow walkway.
- Closely fenced area, or any location that can build up a concentration of fumes such as a stairwell, covered breezeway, etc...

Do NOT terminate vent below air inlet.

- It is recommended that at least 3 ft of vertical pipe be installed when the stove is vented directly through a wall - this will create a natural draft, which will help prevent the possibility of smoke or odor venting into the home during a power outage.



Venting

Adding bends in the exhaust path restricts air flow, reduces performance, and provides a collection point for ash deposits requiring more frequent cleaning.

⚠ CAUTION!

- Do **NOT** connect to any air distribution duct or system.
- Do **NOT** install a flue damper in the exhaust venting system of this stove.
- Do **NOT** Connect this stove to a chimney flue serving another appliance.
- The structural integrity of the manufactured home floor, wall, and ceiling/roof must be maintained.

Required: Only use a 3" or 4" type "L" or "PL" pellet venting system (such as DuraVent or Selkirk).

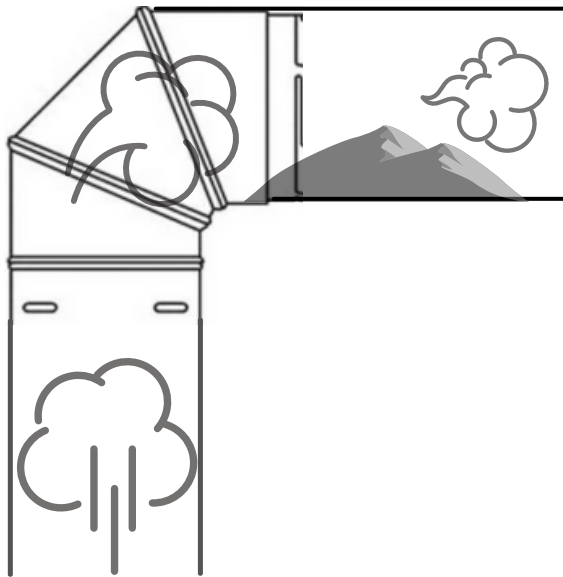

1. Mark and cut wall for venting penetration on exterior wall (if needed).
2. Install wall thimble (sold separately) per manufacturer specifications.
3. Install venting.
4. Use a sealant (such as silicone) to create an effective vapor barrier at the location where the chimney or other component penetrates the exterior of the structure.



⚠ CAUTION!

Ensure that your stove venting terminates above the stove or the follow may occur:

- Improper drafting.
- Smoke may seep into the house.
- Excessive soot.

Install at least one smoke detector on each floor of your home to ensure your safety.

They should be located away from the stove, and close to the sleeping areas.

You should have separate CO monitors for areas near the stove

Install pellet venting through wall and connect vent/pipe to stove

- The pellet venting pipe (also known as L vent) is constructed of two layers with air space between the layers. This air space acts as an insulator and reduces the outside surface temperature of pipe to allow a clearance to combustibles.
- A cap must be used at the termination of type L vent chimneys.
- For elevations above 5,000 feet above sea level, 4" venting is recommended. (Unless total length of venting is less than 6' and uses no more than 1 elbow)
- Some venting manufacturers offer pellet stove adapters for their venting for easier installation.
- Seal all pipe joints per the pipe manufacturer's instructions.
- Secure exhaust venting system to the Stove per the pipe manufacturer's instructions. (Usually by using high-temp silicone (500°+)
- Install termination cap.
- Confirm all required Stove clearances to combustibles.
- The vent must have a support bracket every 5' of pellet vent when on the exterior of the structure.



Required: Use a 3" appliance adapter as your first connection to the exhaust port of the stove. Secure the appliance adapter to the exhaust port of the stove using a high temperature sealant. (Such as RTV silicone)



Venting (Continued)

Pro Tip: Installing a clean-out “T” (sold separately), when venting vertically, can save time during cleaning, and is recommended to aid in the periodic cleaning and maintenance. Be aware of leak potential when installing an interior Tee.

- Do not install flue damper in the exhaust venting system of this unit.
- Use an approved wall thimble when passing the vent through walls. Use a ceiling support/fire stop spacer when passing the vent through ceilings. (Make sure to maintain minimum clearances to combustibles).
- If using more than one T-vent or exceeding 180° of elbows, the use of 4" venting pipe is recommended.
- The vent must have a support bracket every 5' of pellet vent when on the exterior of the structure.
- Horizontal sections of vent pipe should have a 1/4 inch rise per foot. We recommend using the shortest venting and fewest elbows possible when venting horizontal.
- Due to the potential for fly ash accumulation in horizontal venting sections, the maximum permissible horizontal venting length is 4 ft.
- Contact local building or fire officials about restrictions and installation inspection requirements in your area.
- Contact your local authority (such as municipal building department, fire department, fire prevention bureau, etc.) to determine the need for a permit.

Pro Tip: Use the bottom adjustable leveling feet for vertical movement of the stove up to 3/4".

Outside Air Intake (*available separately*)

- Connection from the intake pipe (*2" diameter pipe in rear of stove*) to the outside of the house is REQUIRED for mobile home installation. It is recommended in tightly sealed homes with exhaust fans such as kitchen or bathroom fans, or in basement installations. This will eliminate poor performance due to negative pressure.
- Only noncombustible pipe 2" (*or greater*) in diameter is approved for outside air connections (*Straight or flexible*). PVC pipe is NOT approved and should NEVER be connected to the stove.
- If the air inlet is connected to the outside, it MUST be terminated with a vertical 90° bend down, or with a wind hood. Failure to do so could result in a burn-back if high winds blow directly into the air inlet during a power outage.
- Blockages, excessive length (*more than 8 ft.*), or excessive bends in the air intake pipe could lead to starvation of combustible air to the stove.

Notice: The operation of exhaust fans, such as bathroom and attic fans, could create a negative pressure in the room, causing the stove to be starved of combustible air. Be sure to provide adequate ventilation in the room the pellet stove is located. If not, the vacuum pressure switch may shut off the operation of the pellet stove.

Equivalent Vent Length: Comfortbilt pellet stoves depend on a combustion fan to pull air through the unit for combustion. The venting system restricts the ability of the combustion fan to move the required amount of air through the unit. A system with too much resistance will result in incomplete combustion, more frequent required cleaning and poor unit performance. It is always best to choose a location for the appliance that will result in a venting system with the shortest equivalent vent length (EVL).

The following chart shows the equivalent vent length for common pellet vent components.

Equivalent Vent Length:

- 90° Elbows or Tee: (Each) **5 EVL Units**
- 45° elbow: (Each) **3 EVL Units**
- Horizontal Pipe or liner: (Per Ft) **1 EVL Units**
- Vertical Pipe or Liner: (Per Ft.) **½ EVL Units**

Maximum allowable equivalent vent length:

- **17 EVL** for 3" pellet vent pipe or liner
- **27 EVL** for 4" pellet vent pipe or liner

INSTALLATION



Simple Horizontal Installation

Installation

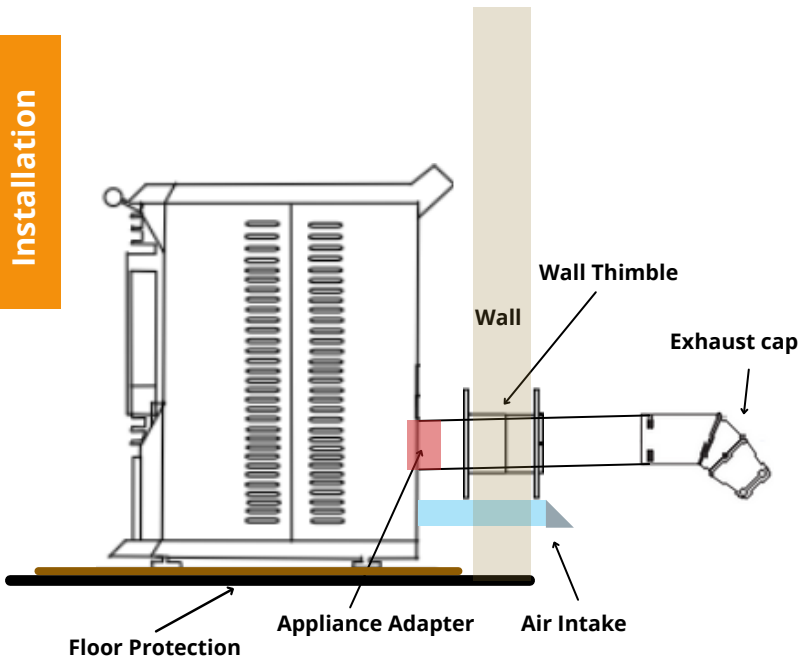

Notice: Excessive embers/sparks can exit exhaust cap if less than 4 ft of venting is used with no vertical rise.

Mobile Home Installation

Installation in a mobile home should be in accordance with the manufactured home and safety standard (HUD), [CFR 3280, Part 24](#). This stove must be vented to the outside. In addition to the standard installation instructions, the following requirements are mandatory for installation in a mobile home:

- The stove must be permanently attached to the floor.
- Stove must have an outside air source.
- Stove must be electrically grounded to the steel chassis of the mobile home, unless grounded or GFCI power outlets are provided.
- All vertical chimney vents must have wall supports.
- All exhaust systems must have a spark arrestor.
- Check with local building officials to see if other codes may apply.
- Structural integrity of the floor, wall and ceiling/roof must be maintained.

Simple Vertical Installation (preferred)

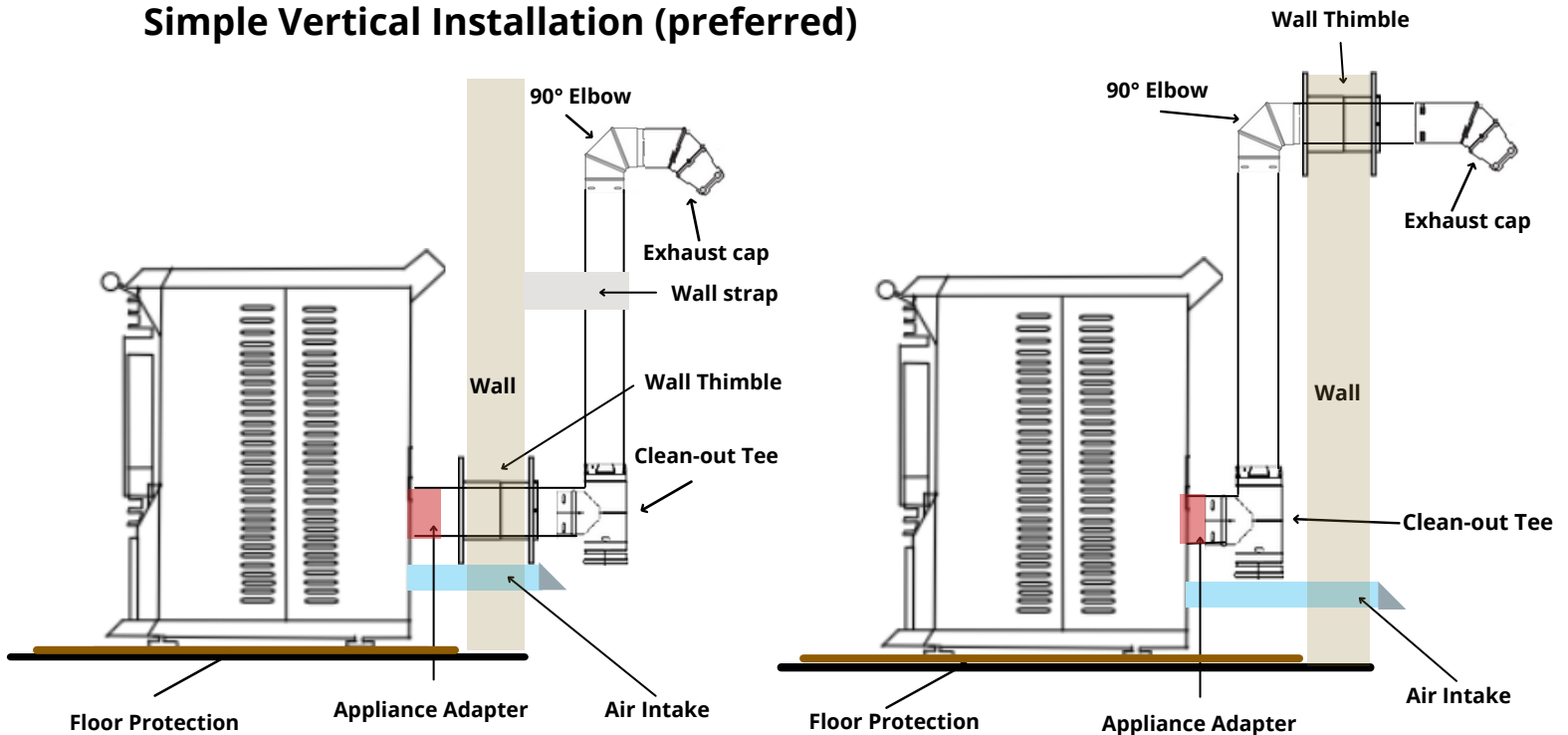

Notice: For Canada, the installation must conform to CAN/CSA-B365

INSTALLATION



Through Roof Vertical Installation

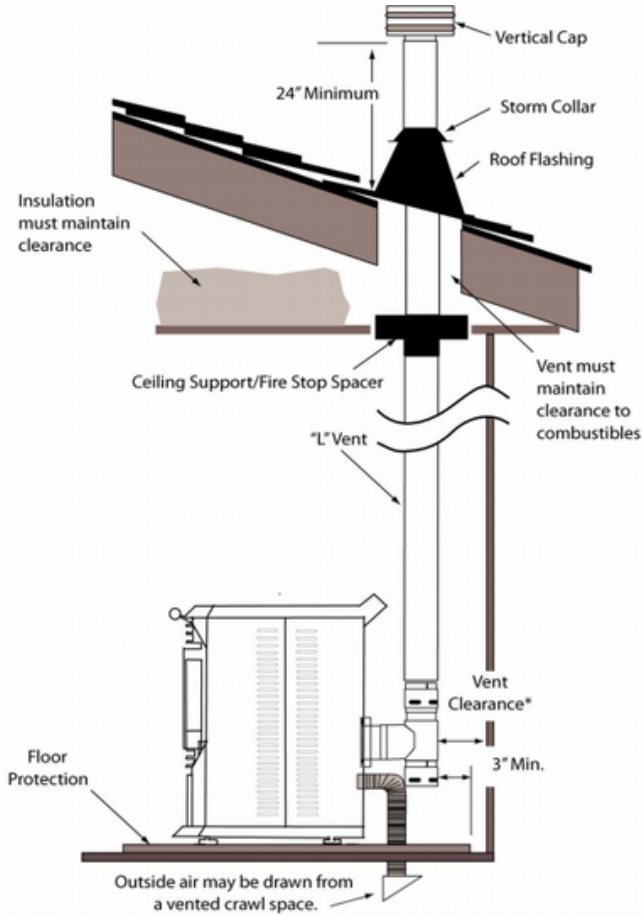

Class A Chimney Retrofit Installation

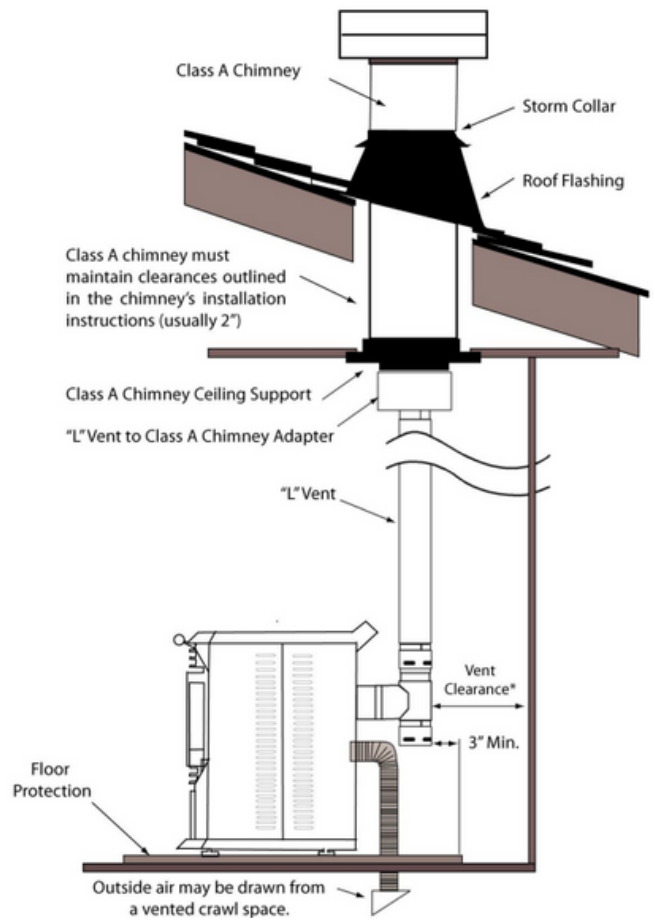

Installation

Masonry Fireplace Hearth Install

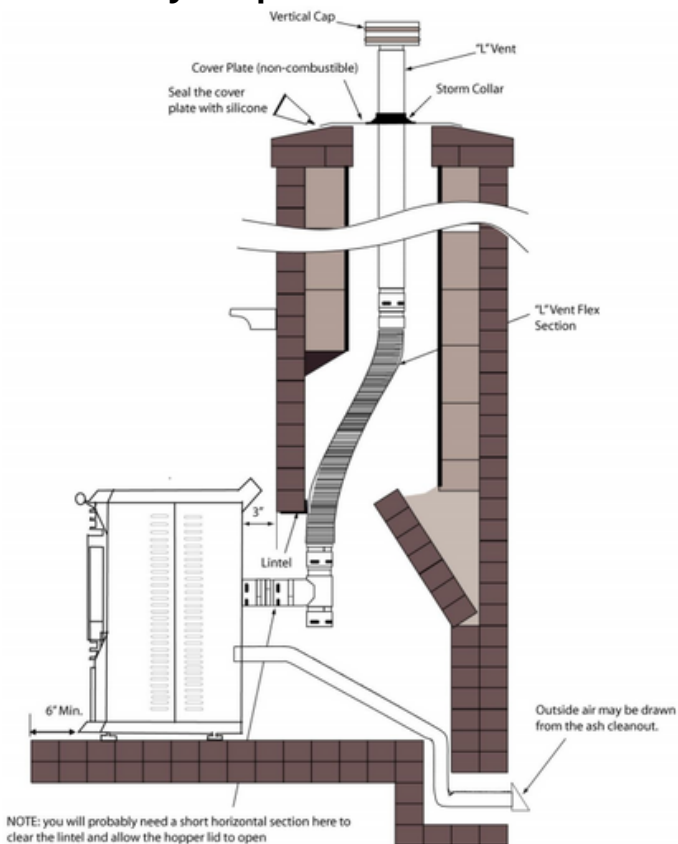

NOTE: you will probably need a short horizontal section here to clear the lintel and allow the hopper lid to open

Freestanding Masonry Chimney install

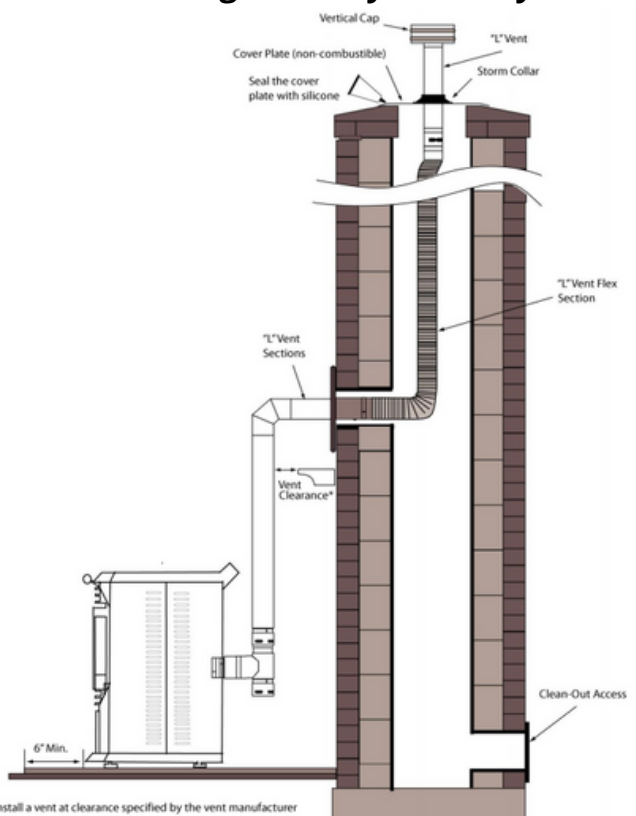

* Install a vent at clearance specified by the vent manufacturer



Fuel Guide

Fuel Material and Storage

- Wood pellets are generally produced out of wood waste such as sawdust and shavings. The raw material is dried, mechanically fractionated to size and extruded into pellets under high pressure.
- This pellet stove is designed and approved to burn wood pellets, that comply with pellet fuels industry standards. Minimum of 40 lbs. density per cubic foot, 1/4" to 5/16" in diameter, with a maximum length of 1", and less than 1% ash.
- The performance of your pellet stove is greatly affected by the type and quality of the wood pellets you use. As the heat output of various quality wood pellets differ, so too will the performance and heat output of the pellet stove.
- We recommend trying various brands and types before purchasing single-ton or multi-ton lots to ensure satisfaction. A 5-bag sample of pellets will give a good indication of what to expect from a certain brand/type.
- Wood pellets need to be protected from direct exposure to moisture. Water, from sources such as condensation and humidity, causes pellets to expand and break down into unusable fuel.
- Store fuel in dry location, not within clearances to combustibles of your stove.
- It is important to select and use only pellets that are dry and free from dirt and debris. Dirty fuel will adversely affect the operation and performance of the unit, and can void the warranty. The Pellet Fuel Institute (PFI) has established standards for wood pellet manufacturers. Only use pellets that meet or exceed PFI standards for premium fuels.
- Depending on the source material, pellets may have differing ash contents.

Higher Ash Content Material:

- Hardwoods with a high mineral content.
- Fuel that contains bark and other impurities.
- Standard grade pellets.

Lower Ash Content Material

- Most softwoods.
- Fuels with low mineral or impurity content.
- Most premium grade pellets.

Pro Tip: We recommend using Pellet Fuels Institute (PFI) certified pellet fuel with this stove.

- The type of fuel you are burning will dictate how often you have to clean your fire pot.
- If the fuel you are burning has a high dirt or ash content, it may be necessary to clean the burn pot more than once per day.
- Poor quality fuel will cause clinkers to form in the burn pot. Clinkers are formed when non-combustible impurities are super heated and become glass-like.

Notice: Tested and approved for wood pellet fuel only. Burning any other type of fuel voids warranty. *(Cord wood, wood chips, corn, shells, cherry pits, etc...)*

WARNING!

Do Not Burn:

- Garbage, Lawn clippings or yard waste, Materials containing rubber, including tires, Materials containing plastic, Waste petroleum products, paints or paint thinners, or asphalt products, Materials containing asbestos, Construction or demolition debris, Railroad ties, or pressure-treated wood, Manure or animal remains, or Paper products, cardboard, plywood, or particleboard
- Burning these materials may result in the release of toxic fumes or render the heater ineffective and cause smoke.



Getting Ready

What to Expect

- Combustion blower will turn on. *(Panel will display "Igniting")*
- Igniter will heat up.
- Auger system will deliver pellets into the burn pot. *(Smoke may occur during ignition but will evacuate once the flame appears in the burn pot.)*
- Convection blower will turn on once the stove heats up. *(Panel will display "Heating")*
- Combustion and convection blowers will continue to run even after your stove has been shut down. *(Panel will display "Fire off" or "Cooling")*

Pro Tip

- Odors and vapors are released during initial startup after purchase, and may persist for several days. Burning your stove on a higher level will speed the curing process. Open windows or doors for air circulation until curing/burn off is complete, or perform a "pre-burn" outdoors.
- During startup and operation, the stove's front door must be closed.
- Priming is only required the first time the stove is lit, or after a "Low Temperature" fault due to low pellets in the hopper. *(see Pre-ignition checklist)*

Understanding Your Stove

- Your stove utilizes a vertical auger fuel feed system that is operated by a microprocessor controlled digital circuit board. The digital circuit board allows the vertical auger fuel system to run in a timer based, non-continuous cycle. This cycling allows the auger to run for a predetermined amount of time. The auger pushes pellets up a chute located in the hopper. The pellets will then turn and fall through another chute into the burn pot.
- Your stove is equipped with an automatic ignition system that should ignite the fuel within 5 minutes of displaying "Igniting".
- As pellets fill the burn pot and ignite, outside air is drawn through the fuel and heated during the combustion process which is then pulled across the heat exchange tubes by the exhaust motor.
- As the stove reaches operating temperature, the room air is then circulated through the heat exchange tubes by a room air blower (convection blower), distributing warm air into the room.
- The amount of heat that is produced by the stove is proportional to the rate of fuel that is burned.
- Because a forced draft pressure is required for the combustion process inside the stove, it is extremely important that the exhaust system be properly installed and maintained.
- Front glass and ash pan doors must remain closed while in operation and the seals on the doors must be properly maintained.

WARNING! Fire Risk:

Keep combustible materials, gasoline, and other flammable vapors and liquids clear of the stove.



- Do NOT operate stove with door open.
- Do NOT operate stove without the ash pan drawer in place.
- Do NOT operate stove without burn pot in place.
- Do NOT store flammable materials in the stove's vicinity.
- Do NOT use gasoline, lantern fuel, kerosene, lighter fluid or similar liquids to start a fire in this stove.

Keep all such liquids well away from the stove while it is in use, as combustible materials may ignite.



Control Panel Operation



- 1) **Infrared Receiver:** Receives signal from remote control. *(Included)*
- 2) **Power Indicator:** Illuminates when main power is switched on.
- 3) **Alarm Light:** Illuminates when a fault is encountered (*Low Temperature, High Temperature, Ignite Failed, etc... see troubleshooting section for more information*)
- 4) **On/Off Button:** Starts and stops operation of the stove.
- 5) **Information Button:** Allows you to read the real-time status of the stove at any time.
- 6) **Mode Select Button:** Allows you to set the unit to one of four operational mode settings: Manual, Temp, Weekly, and Thermostat. *(Thstat mode requires wired thermostat to work correctly. See wiring diagram)*
- 7) **Combination Function Button:** After you press this key, the alarm indicator will light. You can then press another key to complete an operation. See the combination key function list below:
 - Button 6: Timer *(use scroll up and down to change value)*
 - Button 11: Feeding On *(Used to prime the auger)*
 - Button 9: Stop Feeding *(Used when auger priming is finished)*
 - Button 4: Child Lock *(Hold button 4 for three seconds to activate child lock. Hold button 9 for three seconds to disengage child lock)*
- 8) **Scroll up Button:** Allows you to scroll up to choose items in the menu.
- 9) **Exit Button:** Takes you out of current selection and returns to previous option and/or screen.
- 10) **Scroll Down Button:** Allows you to scroll down to choose items in the menu.
- 11) **Enter Button:** Pressing "Enter" button allows you to adjust and select data on the screen. Pressing the "Enter" button for 3 seconds will take you the "Set Data" menu, where you can alter settings such as time, combustion, and weekly schedules.



⚠️ WARNING! Shock Hazard.

- Plug directly into properly grounded 3 prong receptacle.
- Do NOT route power cord under or in front of the stove.
- The use of a surge protector is recommended.



Control Panel Display

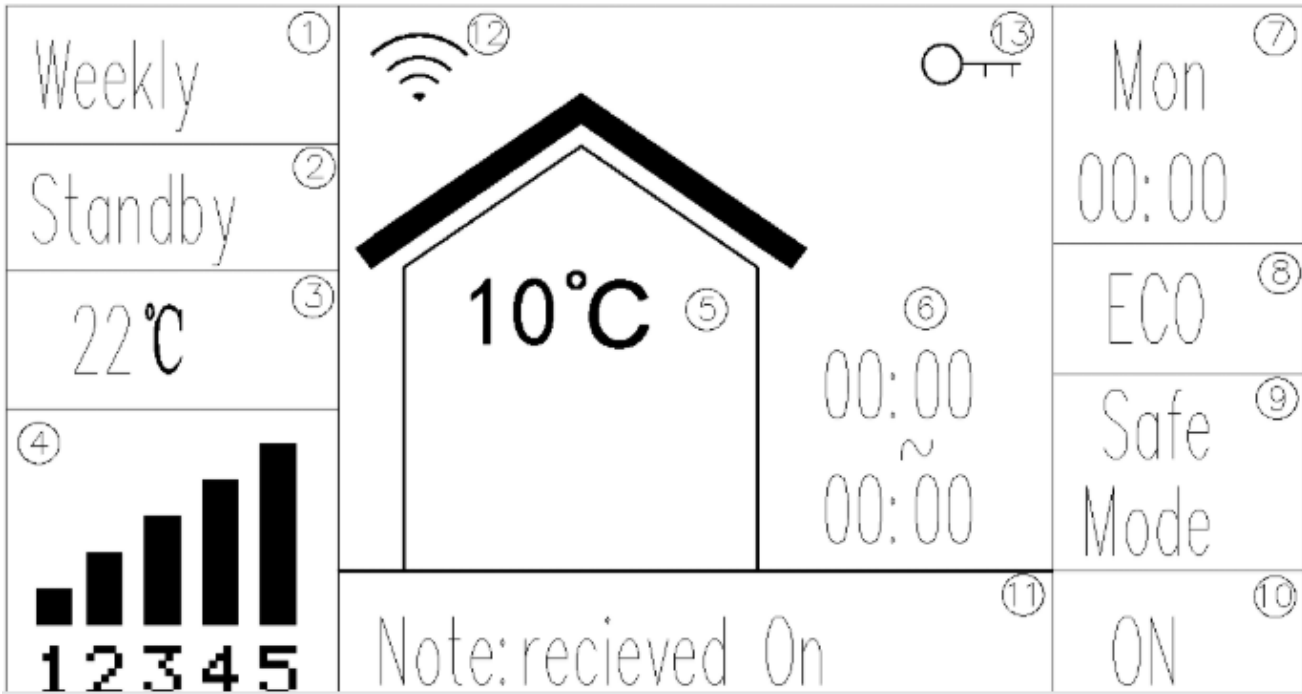





Operation

1. **Mode:** Displays the current operation mode. (*Manual, Temp, Weekly, or Thermostat*).
2. **Work Stage:** Displays the operational stage the stove is currently in. (*Igniting, Heating, Fire Off, Cleaning, Standby, Stop, etc...*)
3. **Desired Temperature:** In Temp or Weekly mode, this will show the currently set temperature.
4. **Heat Power Level:** Displays the current set Heat level. (*In Manual mode, you can directly set this. In other modes, this will change automatically, based on other requirements set by the stove*)
5. **Current Temperature:** Displays the temperature that is being read by the room temperature sensor wire.
6. **Current Time Period:** In weekly mode, this displays the current time setting.
7. **Day and Time:** Displays the day of the week and current time.
8. **ECO Mode Indicator:** Indicates when ECO is currently active. (*ECO allows the stove to cycle on and off automatically in the Temp and Weekly modes*)
9. **Safe Mode Indicator:** If the vacuum or limit switches are being bypassed, the stove will display the word "Safe Mode" in this box. (*See Settings for more info*)
10. **On/Off Indicator:** Indicates if the stove is on and in operation or in the process of shutting down.
11. **Information Bar:** Displays real-time messages. (*such as "feeding on" when performing auger priming for instance*)
12. **Wi-Fi Indicator:** (*Requires wi-fi adapter, not currently supported*)
13. **Child Lock Indicator:** Indicates when child lock is currently active. (*Child lock will lock the panel so no other buttons can be pressed*)



Pre-Ignition Checklist

1. **Check Hopper** - Make sure the hopper is clean and free of foreign matter. *(Including pellet fines and dust).*
2. **Fill Hopper** - Fill the hopper with wood pellets. *(Make sure that NO parts of the bag or any foreign objects enter the hopper, as this may cause harm to the auger feed system).*
3. **Close Hopper Lid** - Take care to ensure there is no pellet material on the hopper lid seating surfaces. *(This stove has a safety switch that will not allow pellets to feed with the hopper door open or ajar).*
4. **Check Igniter** - Ensure that the igniter rod is in a good position, and did not shift during transit. *(Centered in the tube and 1/4" - 1/2" back from flush)*
5. **Check Burn Pot** - Seat the burn pot flush on the air intake/igniter cradle. Ensure that the igniter port hole is toward the back, and that the lip of the burn pot is not resting atop the front square catch.
6. **Close Front Door** - Ensure the main glass door is closed. *(This stove has a safety switch that will not allow pellets to feed unless there is a negative pressure detected inside the stove).*
7. **Check Ash Pan Latches** - Check the adjustable side latches for the ash pan. Both should be snug and have close to even pressure.
8. **Adjust Heat Tube Scraper** - Push the heat tube scraper all the way in and out of the way. *(Knob and rod may get extremely hot during operation)*
9. **Plug Unit In** - Plug the power cable into the power outlet at the wall, and into the main power switch assembly block at the back of the stove. Then flip the power switch to the On position. *(- is on, 0 is off)*
10. **Boot Up** - The panel will boot up, displaying the logo screen and the current program being used. It should read: **HP60S_U01 115V 60Hz** quickly before displaying the home screen.
11. **Prime Auger** - Now test and prime the auger system. Press the Combination Function button . *(A red indicator light will come on).* Then the Enter button . A "Feeding On" message will display on the screen, and the auger will engage to slowly draw pellets into the drop chute. After about a minute, pellets should start dropping into the burn pot. Once pellets start to feed, press the Exit button  to stop the feeding. A "Feeding Off" message will display. Now press the Combination Function button  again *(the red indicator light will go out).*
12. **Ready to start** - The stove is now ready to start. *(Empty any extra pellets from the burn pot before igniting)*

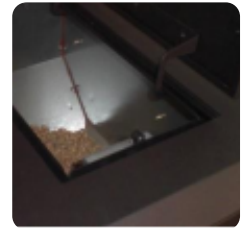

3. Hopper Lid Switch



4. Igniter



5. Burn Pot catch



8. Heat tube scraper



9. Power switch block

Notice: Every ignition sequence assumes an empty burn pot. Fuel left in the burn pot prior to ignition can cause the following: Delays in ignition, excessive smoking, puffing starts, and over-large fires.



Operational Modes

Before actually starting your stove, you will need to determine which operating mode you would prefer the stove to run in. This stove can operate in one of three modes - Manual, Temp, and Weekly.

- **Manual:** In this mode, you can adjust and set the heating power level to control the heat level. (1 - 5)
- **Temp:** In this mode, you can set the room temperature and the stove will automatically adjust the heating power level to maintain the desired temperature. (*Turning ECO option on in the settings will allow the stove to cycle on and off automatically based on the desired temperature*)
- **Weekly:** In this mode, the stove will work automatically during days and times you predesignate. You can have a program for each of the 7 days of the week, and up to 4 periods during the day.
- **Thstat:** In this mode, it uses a simple wired thermostat to control the fire on and fire off cycles.
- Pressing the mode select button  will cycle through all of the different operating modes.
- You must select your mode before turning on the stove. (*Current mode will display in the upper left hand corner of the display screen*)
- Selecting a mode while the stove is burning may cause the stove to shut down and could force a 30-minute cool-down delay in restarting. You do not need to start operation of the stove to select your mode. To choose the mode, locate the mode select button on the controller.

Manual: In the manual mode, you have the ability to change the heat levels, which will increase or decrease the amount of heat that the stove puts out.

- To change the power level in manual mode, use the "Scroll Up" or "Scroll Down" buttons on the control pad.
- Pressing either of these buttons once will move the power level up or down one level.

*NOTE: Manual mode allows you to directly change the heat level of the stove. (1 - 5 bars)
It does not allow you to adjust specific temperatures. (see Temp)*



Temp: The Temperature Mode allows you to set the desired temperature of the room. The stove will increase or decrease the heat level automatically to keep the room close to the set desired set temperature.

- To increase or decrease the "Call to" temperature, use the "Scroll Up" or "Scroll Down" button. The current room temperature will be displayed in the temperature display box on the screen, as will the "Call to" temperature.
- If the room temperature falls below the "call to" temperature, the stove's heat power level indicator will automatically rise to five. When the temperature has been reached, and maintained for about a minute, the heat power level will return to one and it will stay there until more heat is needed.
- The desired or "Call to" temperature has a range of 61 - 82° F (16 - 28° C)

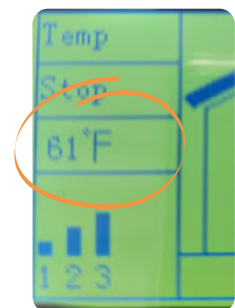

NOTE: In temperature mode, the stove will not shut off or go into standby. It will simply idle and continue to produce a fire until the room temperature falls below the "call to" temperature. When idling, the heat power level will read at level one in the power level box on the display screen. In order to allow the stove to cycle off and on automatically, the ECO option (see the "Settings" section) will need to be turned on.

Weekly: The Weekly Mode allows you to control and schedule the stove operation during set times and days throughout the week.

- You can select four different operation times for each of the seven days of the week.
- During the Weekly operation mode, the stove will run in a very similar way to "Temp" mode. Part of the weekly schedule program includes a desired "call to" temperature.
- See the "Set Data" section for more information on programming the weekly schedule.

IMPORTANT: Remember to set your weekly schedule in Weekly Mode before igniting a fire. If you attempt to set a weekly schedule while the stove is running in Manual or Temp modes, the weekly schedule will not set, and the screen will prompt you to wait until you have turned the stove off and it has cooled down before allowing you to retry.



Operational Modes (Continued)

Thstat: The Thstat Mode allows you to control the stove via a wired remote thermostat. *(The stove will only work in this mode if connected to a thermostat)*

- A thermostat is a simple switch that is temperature activated.
- When the thermostat engages, you will see an "ASKED" message on the screen. This is a call for heat, and the stove will automatically ignite, and run.
- When the thermostat disengages, you will see a "NONE" message on the screen, and the stove will then go into a fire off mode, and allow the fire to die down and then go into standby for the next call for heat.

Operation

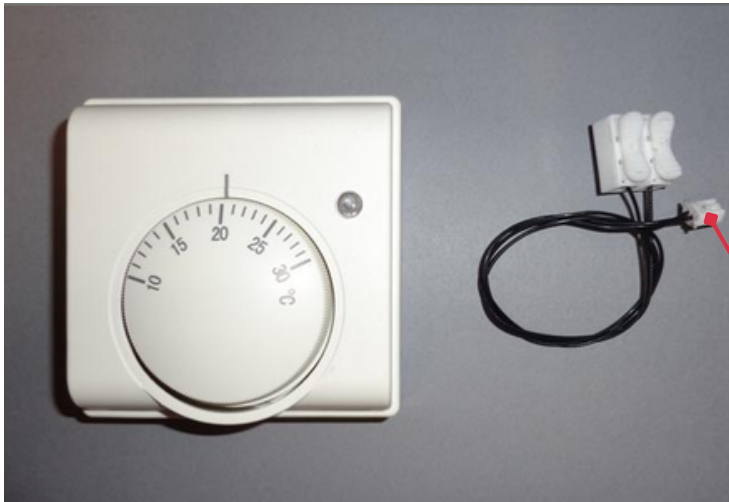

Connecting a Thermostat: Connect the "Call for Heat" extension wires from the thermostat to the bottom circuit board.

- Remove the right side or rear panel to access the circuit board.
- Remove the lid by removing the 4 Philips screws in the corners.
- Connect the thermostat lead wire to the plug labeled "Level" as shown.

Remote Control

All Comfortbilt pellet stoves come with an infrared remote that can control the panel.

- To activate the remote, pull the plastic battery separator tab from the back battery compartment.



- **On** - This button will start the stove (similarly to pressing the power button on the panel)
- **Off** - This button will stop the stove (similarly to pressing the power button on the panel)
- **Manual** - This button will put the stove into Manual mode
- **Temp** - This button will put the stove into Temperature control mode.
- **Up** - This button will increase the heat level (in Manual mode) or the set temperature (in Temp mode).
- **Down** - This button will decrease the heat level (in Manual mode) or the set temperature (in Temp mode).
- **Hold and Unhold** - These buttons no longer do anything, as there were for a previous version of the software.

- When the stove is started from the remote control, the panel backlight will stay off.
- This remote control uses a 3V CR2025 Lithium battery.



Starting your Stove

After you have chosen the desired operation mode for your stove, press the ON/OFF button to start the stove's ignite cycle.

- When the stove turns on, "Igniting" will appear in the work stage box on the screen.
- Once the fire is lit, and the stove achieves operating temperature, the work stage box on the screen will read "Heating", and the room blower fan will engage.
- During operation, the stove may display "Cleaning" periodically. This is an automatic cleaning that the stove will perform.
- The stove will continue operation until something interrupts that operation. (Low Temperature alerts due to low pellets in hopper for example).

Information Screen

At any time, you can press the Information button (#5) once to access the Running information screen.

- On the top half of this screen, it will display running information such as On/Off status, current heating level, current run time, and Eco and WIFI indicators.
- On the bottom half of this screen, it will display a real-time diagnostic readout, that shows which devices are currently engaging, as well as Hopper Temperature, and Room Temperature readouts. (*HT and RT*)

Pressing the Information button a second time will access the Stove information screen.

- This screen will display information such as: Total ignite times, total running time, and program and power information.

Note: The correct information for this stove is the following:

- Model: HP60S_U01
- Voltage: ~115V
- Frequency: 60Hz

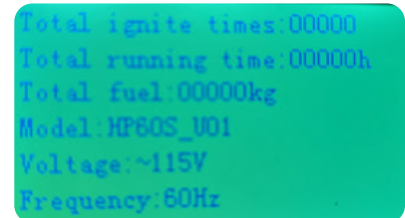
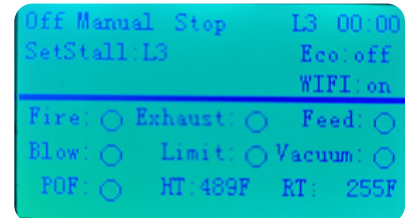
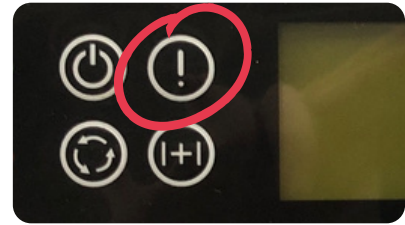

Operation

What Does a Good Fire Look Like?

A good flame will be an active torch with a bright yellow center. Streaking of blue near the bottom of the burn pot is also a good sign of decent airflow pressure. Ash should reduce to a fine light gray powder. Gritty brown ash and fuel being ejected from the pot before fully reducing usually indicates too much air pressure under the burn pot, while dark/black ash or lazy, darker flames indicates an air shortage.





- Level 1: The fire height may fluctuate up and down at this level as there is a lighter feed schedule, but on average the top should be just above the lip of the burn pot.
- Level 3: The fire should be a fairly stable torch that comes up about half way up the chamber.
- Level 5: The fire will be a tall torch, and the tops of the flame should reach to about the underside of the heat tubes.





Settings

There are a number of settings that can be altered or adjusted within your stove. (*Weekly schedules, Time/date, temperature units, etc...*)

- Press and hold the Enter button . This will take you to the "Set Data" screen.
- Use the Scroll Up () and Scroll Down () buttons to navigate through the list, and then press the Enter button to select.
- Press the Exit button  at any time to back out of your current menu or selection. Pressing the Exit button while at the Set Data menu screen will bring you back to the Home Screen. (*After a few minutes of inactivity, the panel will time out and go back to the Home screen*)

Here is a brief description of each of the menu items. A full description of each menu is available later in this section. (pg. 24 - 26)

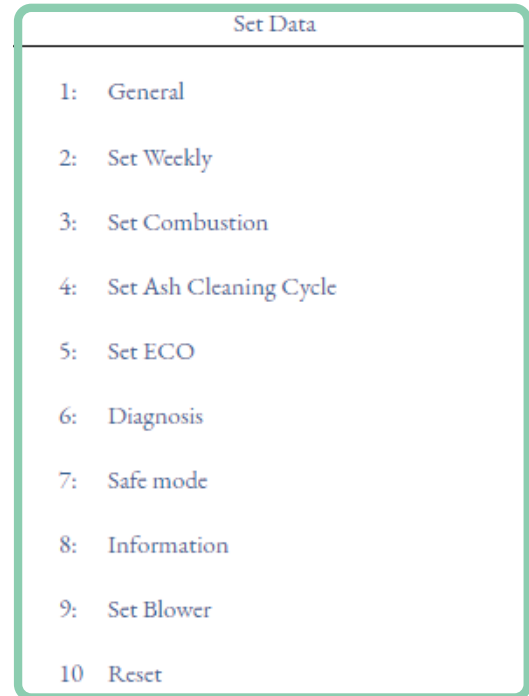

- 1: General** - This menu allows you to set up your Time/Day, Temperature unit readout (C or F), Language, and Wifi settings.
- 2: Set Weekly** - This menu allows you to set a weekly program schedule to be used when the stove is set to the Weekly Operation mode. This schedule can have up to four on/off cycles per day.
- 3: Set Combustion** - This menu allows technicians to alter the stove's Exhaust voltages and Blower voltages for each Heating or Ignition level. (*Feed rates are factory set and should not be altered*)
- 4: Set Ash Cleaning Cycle** - This menu allows you to alter the stove's automatic ash cleaning schedule for each Heating level.
- 5: Set ECO** - This menu lets you to toggle on or off the ECO function, which will allow the stove to automatically cycle on and off based on the desired temperature set in the Temp mode.
- 6: Diagnosis** - This menu allows you to independently test each of the main components of the stove.
- 7: Safe Mode** - This menu allows technicians to bypass one or both of the internal safety switches that have the authority to turn off the auger. (*Limit and Vacuum*)
- 8: Information** - This menu allows you to view some specific information about the stove. (Running info, Stove info, and Wifi History)
- 9: Set Blower** - This menu allows the room blower fan to be toggled On or Off. (*This menu is not used for our pellet stoves, but for devices that do not use blower fans such as boilers*)
- 10: Reset** - This menu will let you reset the programming in the panel to the stored factory defaults, and you will lose all of your user settings.

Notice: In the event the stove loses power, a 3V CR2032 Lithium coin battery, installed in the panel, should hold all of the user settings. Such as: Weekly schedules, Temperature units, and Time/Day

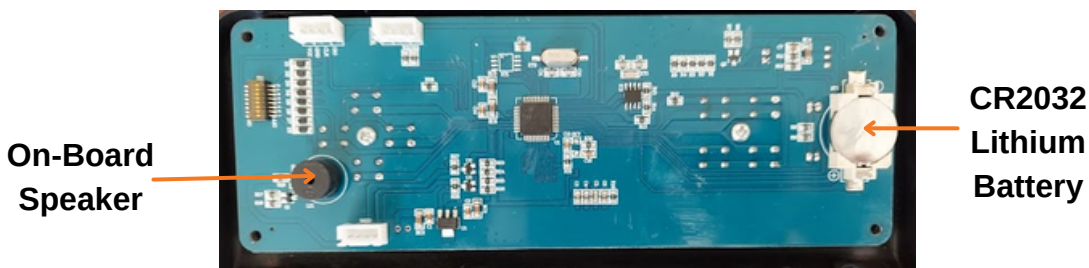



Settings Continued

1: General - This menu has four internal settings.

1. Time and Day
2. Temperature Units
3. Language
4. Wifi Reset / On

- Time and Day: Press Enter to select and highlight the block you wish to edit, use the Up and Down buttons to change the value, and then press Enter again to lock in your edits and highlight the next block.
- Temperature Units: Press Enter to highlight. Use the Up and Down buttons to change between temperature units (*C* or *F*) and then press Enter to confirm your selection.
- Language: Press Enter to highlight. Use the Up and Down buttons to select your desired language, then press Enter to confirm your selection.
- Wifi Reset / On: Press Enter to highlight either the Reset or On option, press the Up or Down button to change the value, and then press Enter again to confirm your selection. *(This option is reserved for future expansion for a wifi adapter, that is not built into the control panel.)*

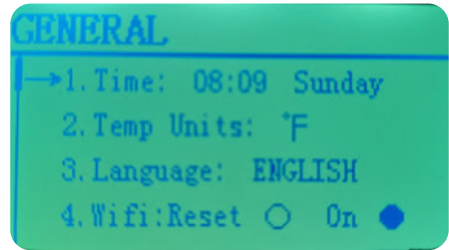

2: Set Weekly - This menu allows you to set up a weekly run schedule for your stove (*for each day*), and will have four independent time blocks. Each block will have the following:

1. Ignite On Time (*24 hour clock / Military time displayed*)
2. Fire Off Time (*24 hour clock / Military time displayed*)
3. Desired Temperature
4. Use Line Item (*Yes / No*)

- Press the Enter button to highlight the Day, press the Up or Down buttons to select the Day you wish to edit, and then press Enter again to confirm your selection.
- Press the Down button to move the cursor arrow down to your first program block.
- Press the Enter button to highlight the "Ignite On time" Hour block, press the Up or Down buttons to change the value, then press Enter again to confirm and highlight the "Ignite On time" minute block. Use the Up and Down buttons to edit the value. Press Enter to confirm, and highlight the next block.
- Press the Enter button to highlight the "Fire Off time" Hour block, press the Up or Down buttons to change the value, then press Enter again to confirm and highlight the "Fire Off time" minute block. Use the Up and Down buttons to edit the value. Press Enter to confirm, and highlight the next block.

Note: The earliest time you can turn the stove on is 00:00 (*Midnight*) and the latest time you can turn the stove off is 23:30 (*11:30pm*) **This forces a minimum 30 minute shutdown between 23:30 and Midnight the next day.*

- Press the Up and Down buttons to select the desired temperature while the stove is running. (*61°F - 82°F*) and press Enter to select and highlight the last block.
- Use the Up and Down arrows to select either Yes or No. (*Yes means to use this line, No means to ignore this line.*) Press the Enter button again to confirm.
- Repeat this process for lines 2 - 4 as desired to set up your weekly schedule.
- To replicate the same program for every day of the week, scroll up to the ALL item at the top right, and press the Enter button twice. (The panel will beep twice to indicate that the program was copied to all days of the week)

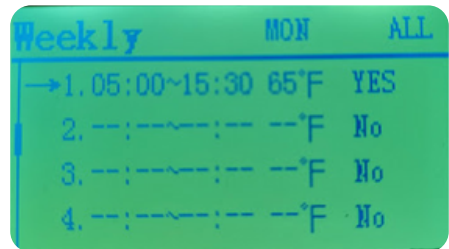

3: Set Combustion - This menu is reserved for authorized personnel to make changes as needed, on an individual basis.

- This menu is password protected to prevent creating a potentially dangerous situation.
- Only Comfortbilt authorized dealers, repair technicians, or technical support representatives can alter any combustion settings.



Settings Continued

4: Set Ash Cleaning Cycle - This menu has three options that are set for a specific heating level. (H01 - H05)

- Press the Up and Down arrows to navigate to the line item you wish to edit, and press Enter to highlight.
- Press Up and Down to edit the value, then press Enter again to confirm.

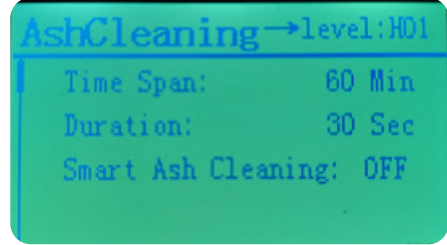

1. **Time Span:** Controls the time span between cleaning cycles. (Minutes)
2. **Duration:** Controls how long the cleaning cycle will last. (Seconds)
3. **Smart Ash Cleaning:** Allows the stove to use a pre-set range of numbers. Gives the option for Light, Medium, and Heavy cleaning cycles. *(Activating this option will gray out the Time Span and Duration options)*

When the stove enters into a "Cleaning" phase, the feeder will pause, and the exhaust fan will increase to let some of the buildup of ash in the burn pot get blown free. *(If you experience a very small flame or "Low Temperature" alerts during this cleaning cycle, reducing the Duration value to 20 Sec or less on level: H01 may help)*

5: Set ECO - This menu lets you toggle on or off the ECO function, which will allow the stove to automatically cycle on and off based on the desired temperature set in the Temp mode.

- Press the Enter button to highlight the Off or On tag.
- Press the Up or Down button to edit the value, and then press Enter to confirm.



When ECO is set to ON, and the stove is operating in the "Temp" mode, the stove will go into "Fire off" mode and shut down when the actual temperature *(in the house)* meets or exceeds the desired, or call to, temperature *(left side of screen)*

Once the exhaust housing is cool, and the actual temperature falls below the desired temperature, then the stove will automatically reignite.

This On/Off cycle will continue until interrupted or turned off.

***ECO will cause considerable wear on the igniter, and require more electricity during the added ignition phases.**

6: Diagnosis - This menu allows you to independently test each of the main components of the stove. You can only enter into the Diagnosis menu when the stove is off and the work stage line shows "Stop" *(at the top left, below the Operational mode)*

- Press the Enter button to cycle through the four main components. Fire, Exhaust, Feed, and Blow.
- Pressing the Up button will place a shaded circle next to the selected component and activate that device.

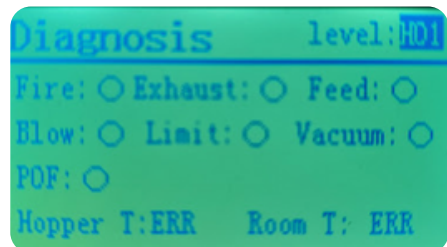

Level: This lets you simulate what level the activated device will run at. (H01 - H05)

Fire: Putting a shaded circle here will engage the Igniter. *(Once activated the igniter should glow at the tip within 3 minutes)*

Exhaust: Putting a shaded circle here will engage the combustion fan.

Feed: Putting a shaded circle here will engage the auger system and feed pellets. *(at the level indicated)*

Blow: Putting a shaded circle here will engage the room blower fan.

Limit: This will engage and become shaded when the hopper lid is closed.

Vacuum: This will engage and become shaded when the main chamber is under negative pressure. *(anytime the combustion fan is running)*

POF: *(Proof of Fire)* This will engage when the exhaust housing is hot. *(above 130° F)*

Hopper T: This will display the current temperature of the Hopper temp sensor. *(Alerts above 197°F)*

Room T: This will display the current temperature of the room. *(Room temperature sensor behind stove)*



Settings Continued

7: Safe Mode- This menu allows service technicians to bypass one or both of the internal safety switches that have the authority to stop the auger from feeding for testing and diagnosing purposes.

⚠ CAUTION!

- Bypassing safety switches can create dangerous situations, and is reserved for technicians only.

8: Information - This menu allows you to view some specific information about the stove. (See information screen on pg. 21)

- Press the Up or Down button to select the submenu you wish to view, and then press Enter to confirm.
- There are three information submenus.
 1. Running Information
 - This submenu will display running information, and will display a screen that is similar to the diagnosis menu that shows which devices are currently engaging. (see #6 Diagnosis)
 2. Stove Information
 - This submenu will display stove information such as: Total ignite times, total running time, and program and power information.
 3. History WIFI Information
 - This Submenu will display wifi history information. (Programmed future expansion)

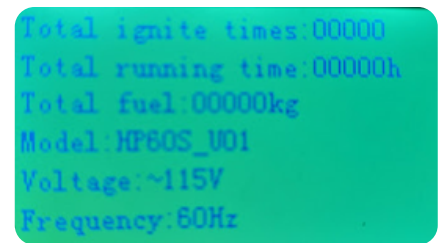
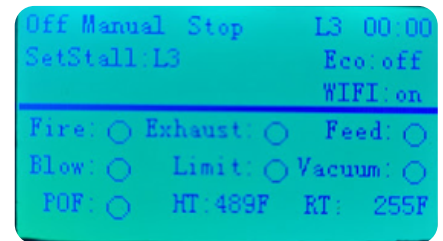
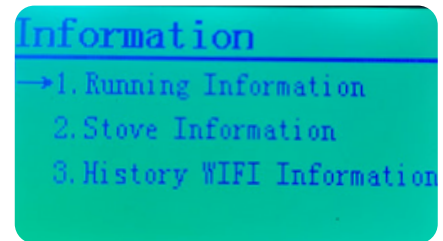

9: Set Blower - This menu allows the room blower fan to be toggled On or Off. (This menu is not used for our pellet stoves, but for devices that do not use blower fans such as boilers)

- Password protected; there is no reason to alter this.
- Setting the Blower to OFF would prevent the stove from being able to transfer internal heat out into the room, and could cause the stove to overheat and shut down.

10: Reset - This menu will let you reset the programming in the panel to the stored factory defaults, and you will lose all of your user level settings.

- Press the Enter button to highlight NO.
- Press the Up button to change the NO to YES.
- Press the Enter button again to confirm.
- The computer will reboot back to the home screen with default settings.

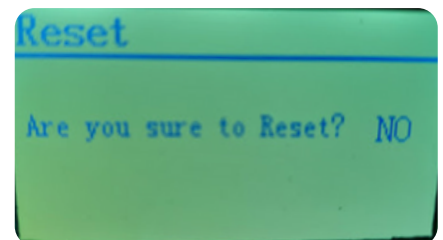



Maintenance & Cleaning

A majority of all problems with pellet stoves are related to general maintenance and cleaning. Regularly cleaning your stove will allow it to function properly and extends the life of most of the stove's components. Due to differences in fuel quality, stove cleaning intervals can vary wildly. However, the cleaner the stove is, the more efficiently it will burn.

⚠️ WARNING!

- Never perform cleaning or maintenance on a hot stove.
- Allow unit to cool completely.
- Interior components may still be hot, even when stove surfaces are cool to the touch. A protective glove is recommended.
- Clinkers may remain hot for several minutes after they are pulled from the burn pot.
- Never perform service with power supplied to the unit.



Maintenance & Cleaning Video

visit: <https://comfortbilt.net/pages/our-videos>
or scan the code.



Side Panel Access

In order to access many of the areas needed to clean, you must first open the side panels that are magnetically held in place.

Each side panel simply pulls free from the front and is hinged from the back to fully expose the internals.



Side Panel Access Video

visit: <https://comfortbilt.net/pages/our-videos>
or scan the code.



Heat Exchanger: Daily or as Needed

Clean the heat exchanger with the pre-installed scraper unit at the top of the stove when the stove is off and cool.

- Pull the chrome knob in and out a few times. (*Keep the front door shut to contain all of the ash as it falls*)
- The soot and ash will fall down to the burn pot and ash pan area.
- Keeping the heat exchange tubes clean will keep your stove's heat exchange process efficient.

⚠️ WARNING!

- Never touch the scraper rod while the stove is hot or running. Severe burns can occur.

Glass Air-Wash System

Below the front door opening, there is a slide damper that can be opened and closed. This is part of the glass air-wash system.

- Keeping the slider to the right will open up the damper and allow some room air to be drawn in and gently washed up the inside of the glass to help prevent excess soot buildup on the glass.
- Optimal location is set to about 1/2 way open, but feel free to experiment for best results for your application.



Maintenance & Cleaning Continued

Burn Pot: Daily or as Needed

Remove and clean the burn pot every time the hopper is filled with fuel, or as needed.

- To empty the burn pot, lift it out of the cradle and dump it directly into the ash pan to either side.
- Make sure all of the airflow holes in the burn pot are unobstructed.
- Be sure any build-up is removed when clearing the airflow holes.
- Using a small metal pick or drill bit can aid you if these get plugged through general use.

NOTE: When reseating the burn pot, ensure that it sits flush on the cradle, and there are no gaps. Gaps around the base of the burn pot can cause airflow leakage and lead to pellet buildups.

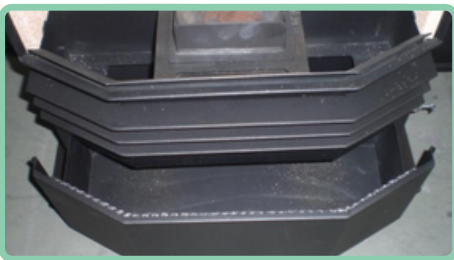

Ash Pan Drawer: Weekly or as Needed

- Ashes should be contained in a metal container with a tight fitting lid. The container of ashes should be placed on a noncombustible floor or, well away from any combustible materials.
- If ashes are disposed of by burial, or otherwise dispersed, they should remain inside the enclosed container until all cinders have cooled.
- The frequency in which the ash pan will need emptied will vary depending on the amount of fuel burned.

NOTE: Ensure that the side latches are snug and have even pressure when drawer is replaced. A loose or uneven drawer can cause pressure leakage and lead to build-ups in the burn pot.

Interior Chamber: Weekly or as Needed

Clean the interior chamber with an ash vacuum once per week or as needed. (Ash vacuums have a metal canister that is specially designed to contain soot).

- Remove the burn pot from the cradle and vacuum beneath.
- Be sure to remove any ash buildup in and around the igniter tube.

NOTE: When cleaning/vacuuming out the igniter tube, ensure that the igniter rod does not get nudged or pushed out of position.



Front Door Glass: Weekly or as Needed

Open the front door and clean the glass when cleaning interior chamber, or as needed.

- Only clean the glass when the glass is cool.
- Wipe the glass clean with a dry or damp rag.
- If this does not remove all build-up, use a non-abrasive cleaner.
- Using ceramic stove top cleaner can be helpful in removing soot build-up from the glass.
- Inspect the gaskets around the door periodically and replace any worn, frayed or compacted gaskets. To replace main door rope gasket, pull the old gasket out of the track, and clean the track with a scraper and mineral spirits/denatured alcohol. Then stretch out the replacement gasket to ensure a proper fit. Run a healthy bead of high temperature caulking around the track, and lay the new gasket down inside, starting and ending on the hinge side of the door.



Maintenance & Cleaning Continued

⚠ CAUTION!

- Do Not operate stove with broken glass
- Do Not slam doors shut.
- Do Not strike the glass.
- Do Not use abrasive cleaners.
- Do Not clean hot glass.
- Replace with factory authorized high temperature ceramic glass only.

(IMPORTANT) Rear Exhaust Chambers: Every ton (50 Bags) of Pellets Burned or as Needed

In addition to daily and weekly maintenance tasks, the exhaust chamber covers should be removed and the entire chamber vacuumed thoroughly once every ton (50 bags) of pellets burned or more often depending on pellet quality.

- First, you will need to locate the cover plates to the rear exhaust chambers. These chamber covers are small, rectangular, metal plates that are affixed with 2 wing nuts or Allen screws.
- There are two total chamber cover plates. One on each side of the stove behind the side panels.
- One is about 6 inches below the air intake damper.
- The other is on the top portion of the square exhaust pipe, adjacent to the exhaust motor housing.

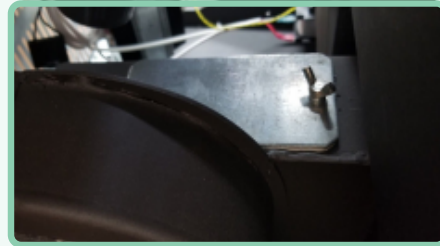

- Once you have located the chamber covers, you will then remove them by unscrewing the wing nuts/Allen screws and pulling the plate back.
- There is a gasket behind the plate to help make an airtight seal so the stove does not draw in air through these panels. It is ok to cut through the center of the gasket to access the chamber behind it. As long as there is adequate gasket material around the perimeter, it will provide a proper seal.
- Using a slender hose attachment for your ash vacuum, thoroughly vacuum out these chambers top to bottom. These chambers extend all the way up to the heat exchange tubes near the top of the stove, so it is imperative that the entire chamber is cleaned.
- Using a sweeping motion with a slender, flexible brush will ensure that no area is neglected and as much of the ash and soot is removed as possible. (1" - 1½" diameter coil brushes work great)

Exhaust Venting & Combustion Blower Housing: Annually or as Needed

The exhaust venting (including Tee cleanouts and elbows), and combustion motor, housing, and impellers should be inspected and cleaned once per year or as needed.

- There is a combustion motor gasket, which allows you to remove the motor from the housing, for inspection and cleaning. If damage occurs to the gasket, a new blower flange gasket may need to be added between the blower flange and the steel plate.
- Do not over-tighten wingnuts during reassembly.

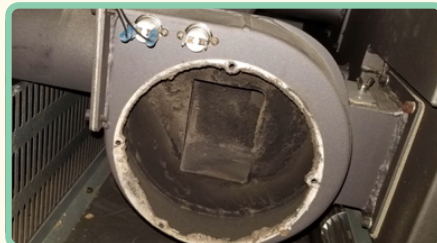



Troubleshooting Videos

visit: <https://comfortbilt.net/pages/our-videos>
or scan the code.



Check out our written guides here: <https://comfortbilt.net/pages/troubleshooting-component-guides>

⚠ CAUTION!

- Whenever performing maintenance on your stove, ensure that the stove is cool to the touch, and that power has been disconnected.

- Fault codes and error messages can be cleared off of the main screen by **pressing and holding the On/Off button for 5 seconds**. *(This acknowledges the error, and allows the stove to be restarted)*

Problem: Total Loss of Power at the Control Panel

A total power loss at the panel indicates that the flow of electricity has been interrupted. The flow of electricity follows this path: Main power cord > rear switch block > wiring harness > main circuit board > data cable > control panel.



Solutions:

- Ensure that the electrical outlet is working properly.
- Ensure that the power switch is set to the On position *(The -- is On, the 0 is Off)*
- Ensure that all of the wires and connections are secure at the power switch, circuit board, and control panel.
- Check the fuse at the back of the main power switch block. *(There is an active and backup fuse located in a pull-out tray. The active fuse is in the saddle, while the backup fuse is in the plastic sleeve)*



Problem: Alarm - Low Temperature *(Check Hopper/Burn Pot Message)*

When the low temp alarm occurs, it means that the computer has lost communication to the proof of fire switch (POF). This usually happens because the fire got too small or went out to embers. A handful of reasons can account for this happening, but the most common is feeder interruptions. *(Caused by low pellets in the hopper, or the hopper lid being left open too long during refueling, for example)*



Solutions:

- Ensure that the hopper is not too low, or that the pellets are not bridging or creating a funnel at the auger mouth opening. *(This can cause low density of pellets, and inconsistent feeding)*
- Check the Ash Cleaning Cycle *(see Settings)*. This cycle may need to be shortened on the lower levels.
- Ensure that the safety switches are staying engaged during operation. *(for example: if the hopper lid is left open, the auger will not feed, resulting in this alert)*
- For chronic issues, switch the leads over to the backup POF switch at the exhaust housing.

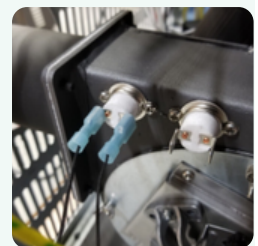



Problem: Alarm - High Temperature/Overheat

The stove giving a High Temp or Overheat alarm could be caused by the room blower not moving enough hot air out of the stove, limited combustion airflow, an improper fuel-to-air ratio in the settings, or an install with excessive bends/elbows.

Solutions:

- Ensure that the room blower fan is working properly, and that the blower voltages are not set too low. *(If the blower fan is not spinning, try to manually flick it to check for resistance)*
- Ensure that the airflow pathways are unobstructed. *(see Maintenance & Cleaning)*
- Ensure that the exhaust fan is not impeded, and is exhausting correctly.
- When operating in Temp mode, ensure that the room temp sensor is not in a cold location, causing the stove to run on a higher level than needed.



Problem: Alarm - Failure to Ignite

The stove giving a failure to ignite message, means that either a fire failed to ignite, or that not enough heat was generated at the Proof of Fire sensor to engage the stove's Heating mode.

Solutions:

- Ensure that the igniter is in a good position, and getting hot at the tip within three minutes. *(see igniter troubleshooting video)*
- Ensure that the burn pot is seated and oriented correctly. *(small hole and ring toward the back of the stove)*
- Ensure pellets are feeding and being delivered to the burn pot. *(see feeder troubleshooting video)*
- *Ensure that the front door and ash pan drawer are properly sealed.*
- *Ensure combustion fan is engaging, and that there is sufficient airflow being drawn through the stove at the air intake pipe.*
- If the fire is established within 5 minutes and maintains a good flame throughout ignition, but the stove fails to switch to heating mode, try moving the wires over from the active Proof of Fire sensor to the pre-installed backup at the exhaust housing.



Problem: Lazy or Dirty Flame / Buildup of Pellets in the Pot / Dark Black Smoke or Ash

If you see a buildup of pellets and/or black smoke in the main chamber or at the end of the exhaust, these are not normal emissions, and usually indicate a reduction of airflow.

Solutions:

- Check for clinkers or blockages in the burn pot, and that the burn pot is seated flush on the cradle. *(Gaps between the cradle and burn pot can allow air to be drawn around the pellets instead of through them)*
- Check for leakages or loose seals/gaskets around the stove, such as around the glass door or ash pan. *(Ensure the side latches of the ash pan are snug with about even pressure)*
- Check for potential blockages in the exhaust chambers or venting. *(see Maintenance and Cleaning)*
- Ensure the intake air damper not closed off. (Loosen the 4mm set screw, and pull outward to open)
**Damper is located at the base of the intake pipe on the inside of the stove, behind the side panel.*





Problem: Auger not feeding pellets

The stove operates, but does not feed pellets.

Solutions:

- Ensure that the hopper is full. When the hopper gets low, the pellets can funnel or bridge, causing a low density feeder problems.
- Ensure that the hopper lid switch, and vacuum pressure switches are engaging. Press the info button (!) to check if Feed, Vacuum, and Limit are engaging.
- Auger may have a buildup or jam. Empty the hopper and try to activate the auger in the diagnosis menu to see if the auger will turn.

**Note: If the auger is making a squeaking or groaning noise, you may want to lubricate the auger system with a lubricant such as graphite powder or white lithium grease.*



Problem: Alarm - Lost Connect

The stove giving a Lost Connect alert means that the panel is receiving power from the circuit board, but it is unable to communicate with it.

Solutions:

- Ensure that the 4-pin data cable is connected snugly into both the back of the control panel as well as into the bottom circuit board.
- Ensure that none of the 4-pin data cable wires have a loose connection at the white plastic connector.
- Ensure that the data cable pinout is the same on both sides, and that the Transmit line (TX) and Receive line (RX) did not get swapped or pinned out incorrectly.



Problem: ERR where room temperature should be

The stove displaying ERR inside the house where the room temperature should be, indicates that the control panel is not receiving accurate temperature data from the room temperature thermocouple sensor.

Solutions:

- Ensure that the room temperature sensor wire behind the stove is not crushed, cut, or damaged in any way.
- Ensure that the room temperature sensor wire is securely connected to the white jumper connection on the circuit board. *see wiring diagram

**Note: The stove will still operate correctly when set to the Manual operational mode.*



Problem: Temperature getting too warm in the room

If the room temperature is getting too warm, it means that the stove is creating more heat than the space is losing over time. This is fairly common during mild temperatures or in the transitional seasons.

Solutions:

- Turn the stove off to allow the space to cool down.
- Set the stove to a lower temperature (in Temp Mode) to allow the smallest fire possible.
- Set the stove to a lower heat level (in Manual Mode) to allow the smallest fire possible.
- If the stove is set to the lowest possible heat level or temperature and is still overheating the space, you can activate the ECO option to allow the stove to automatically cycle on and off based on room temperature data. *See Operation > Set ECO
- Alternatively, you can install a simple, wired, remote thermostat. This can help maintain a more accurate temperature range for the space.



NOTE: Activating the ECO function, or installing a remote thermostat will activate the electronic igniter much more frequently, causing more electricity to be used, and wearing the igniter out much faster.



For the full Lab Reports, visit:
<https://comfortbilt.net/pages/non-cbi>
 or scan the code.



BTU & Efficiency Specifications

Emissions Report No.	104780922MID-001R1
EPA Certified	1.01 grams / hr.
*HHV Tested Efficiency	80.5 %
**BTU Output	9,696 - 40,689 / hr.
***Heating Capacity	Up to 2,800 ft ²
Exhaust Port Size	75mm (3")
Air Intake Port Size	50mm (2")
Hopper Capacity	55 lbs (approximate)
Fuel	Premium Wood Pellets
Shipping Weight	285 lbs

*Weighted average HHV efficiency using data collected during EPA emissions test

**Maximum BTU output based on HHV efficiency and the high burn section of the EPA emissions test.

***Heating capacity depends on climate zone, structure layout, insulation ratings, and other factors.

Electrical Rating (On High)

HP22: 115VAC, 60Hz, Start 4.3 Amps, Run 1.8 Amps

Room Blower: 115VAC, 60Hz, 0.70 Amps

Combustion Blower: 115VAC, 60Hz, 0.55 Amps

Auger Motor: 115VAC, 60Hz, 0.55 Amps

Igniter: 115VAC, 60Hz, 3.2 Amps

Any generator, UPS, or battery backup system must have a **Pure Sine Wave** power signature.

(Partial or modified sine waves can damage electronics, or cause component failures)

**Performing an ignition while on battery backup will severely drain the battery, and may cause damage to the battery cells.*

Glass Specifications

This stove is equipped with ceramic glass.

Replace glass only with ceramic glass. Please contact Comfortbilt for replacement glass.

This manual describes the installation and operation of the Brand Comfortbilt, Model HP22 Series wood pellet stove. This stove meets the 2020 U.S. Environmental Protection Agency's crib wood emissions limits for wood stoves sold after May 15, 2020. Under specific conditions, this stove has been shown to deliver heat at rates ranging from 9,696 to 40,689 Btu/hr.

Complies with ASTM E2012 (R2017), ULC S627-2021, ASTM E2515-2017, ASTM E2779-2017, CSA B415.2010 (R2020)



To register your stove, visit
<https://comfortbilt.net/apps/product-registration>
 or scan the code.



SMG Hearth & Home LLC - Comfortbilt Limited Warranty

SMG Hearth & Home LLC (SMG), on behalf of its Comfortbilt brand, extends the following warranty for Comfortbilt stoves purchased from an authorized retailer.

Customer Care is available to assist you with troubleshooting technical issues.

Please contact Comfortbilt Customer Care at 1-919-973-4079 with any product concerns before contacting the retailer where you purchased your stove.

Warranty Coverage

Subject to the table below, SMG warrants to the owner of the Comfortbilt stove that the stove will be free from defects in materials and workmanship at the time of manufacture. After installation, if covered components are found to be defective in materials or workmanship during the applicable warranty period, SMG will replace the covered components.

SMG, at its own discretion, may fully discharge all of its obligations under such warranties by replacing the product itself or refunding the verified purchase price of the product itself. The maximum amount recoverable under this warranty is limited to the purchase price of the product. This warranty is subject to conditions, exclusions, and limitations as described below.

Warranty Period

Warranty coverage begins on the date of original purchase. The warranty period for covered components is as follows:

Component Covered	Warranty Period
Electrical Components, Burn pot, and Labor	1 Year
Steel parts (excluding burn pot)	5 Years
All replacement parts are covered for remainder of original or extended warranty period or 90 days, whichever is longer.	90 Days

Warranty Exclusions

Warranty does not cover damage or breakage due to misuse, improper handling, or modifications. There is no warranty on the paint, glass, fire brick, or any gaskets, or against damage caused from corrosion. There is no expressed or implied performance warranty on Comfortbilt stoves as SMG has no control over the installation, operation, cleaning, maintenance, or type of fuel burned.

SMG Hearth and Home LLC assumes no responsibility for, nor does the warranty extend to, smoke damage caused by reverse drafting of pellet appliances under shut-down or power failure conditions.

Some states do not allow exclusion or limitation of incidental or consequential damages, or limitations of implied warranties, so the limitations or exclusions set forth in this limited warranty may not apply to you. This limited warranty gives you specific legal rights and you may have other rights which vary from state to state. Warranty is void if the Comfortbilt stove has not been installed, operated, cleaned and maintained in strict accordance with SMG's instructions.

Neither SMG nor the Retailer from who you purchased your Comfortbilt stove shall be responsible, legally or otherwise, for the incidental, or consequential damage to property or persons resulting from the use of this product. Any warranty implied by law, including but not limited to implied warranties of the merchantability or fitness, shall be limited to One (1) year on the breach of this warranty or any type of warranty expressed or implied by law. SMG shall in no event be liable for any special, indirect, consequential, or other damages of any nature whatsoever in excess of the original purchase price of this product. All warranties by SMG are set forth herein and no claim shall be made against SMG on any oral warranty or representation.

WIRING DIAGRAM

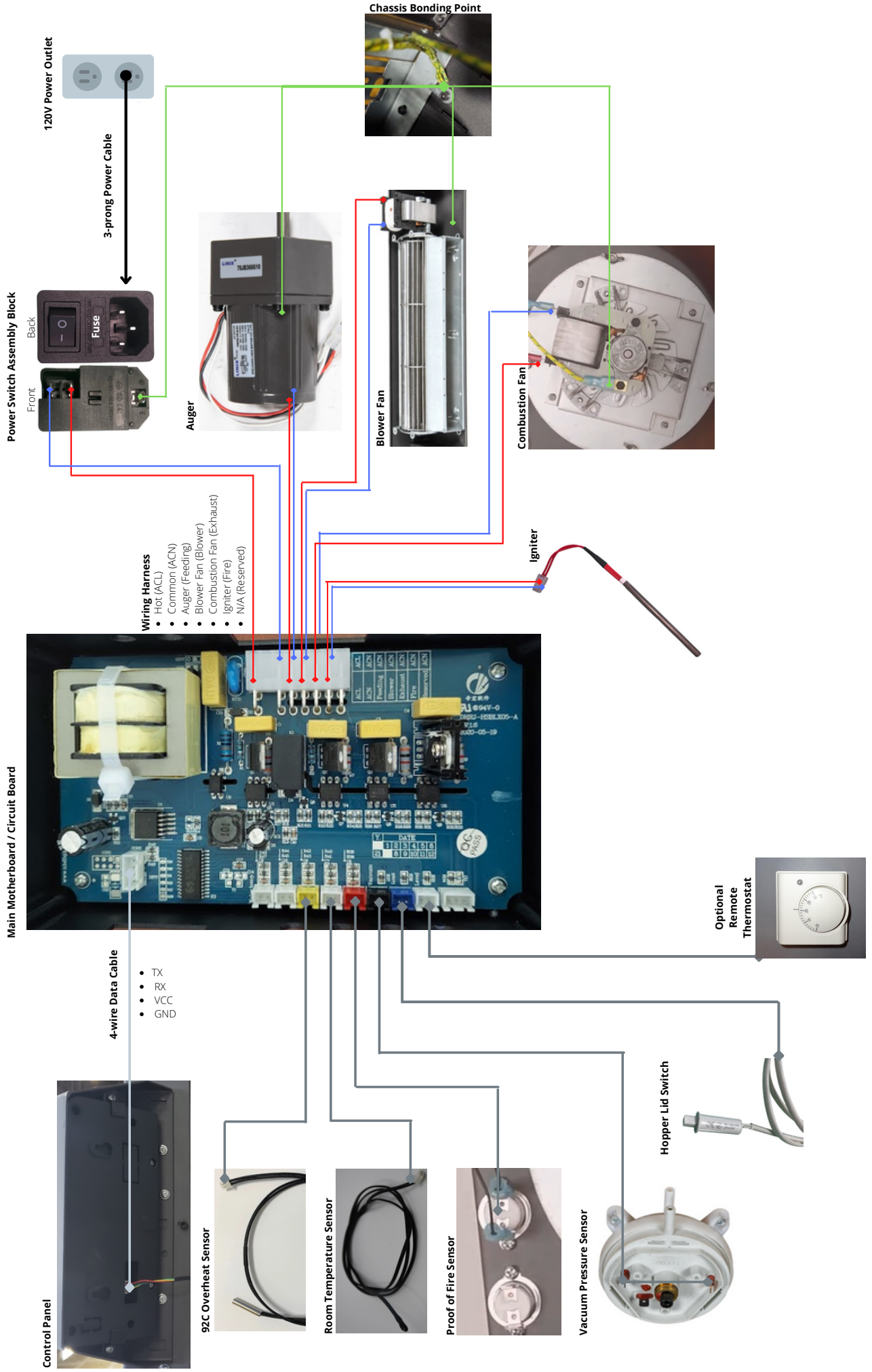

REPLACEMENT PARTS



All of the following replacement parts can be purchased directly from our website. Follow this link or scan the code.

<https://comfortbilt.net/collections/replacement-parts>

Or contact our parts dept. at 919-973-4079 Option 4



Electronics

Part Name	Part ID
Control Panel	CP-22
Circuit Board	MB-2
Igniter	IG-1
Main Power Switch	PS-1
Wiring Harness	WH-22
4-Wire Data Cable	DC-2

Motors & Fans

Part Name	Part ID
Auger Motor w/ Gearbox	AGM-1
Exhaust Fan Assembly	EF-1
Room Blower Assembly	RB-22
Auger Motor Capacitor	AMC

Sensors & Switches

Part Name	Part ID
Vacuum Pressure Switch	VAC-2
Hopper Lid Switch	HLS-2
Proof of Fire Sensor	POF
Room Temp Sensor	RTS
92°C Overheat Sensor	92C

Misc.

Part Name	Part ID
Auger Bearings	ABS
Burn Pot	BP-1C
Door Rope Gasket	RG-22
Auger Bit	AB-1
Remote Control	RC
Exhaust Chamber Gasket	GK-22

*Some replacement parts, such as Burn Pots and Igniters, may also be found on Amazon



QUESTIONS?

CONTACT US:

For the most up to date information, visit:

WWW.COMFORTBILT.NET

9241 GLOBE CENTER DR. STE 120
MORRISVILLE, NC 27560
919-973-4079