

David
Trubridge

Snowflake





Snowflake



Creates a repeating geometric hexagonal pattern based on a snowflake. The light was designed following a trip David made to Antarctica as a visiting artist. Snowflake comes in 3 sizes. The plywood finish can be all natural or painted on one side thus creating a stock selection of 11 options. Snowflake is assembled from a hexagonal snowflake shape which creates a repeating geometric pattern. The light was designed following a trip David made to Antarctica as a visiting artist. It builds on the process he first developed with Coral of using minimal thin sheet material in compound curvature to create.



Features

Shipped Kitset

Seed System kitset lightshades are on average 1/30th of the volume of the assembled light. This aims to help minimize the effects of shipping and to reduce the design's environmental footprint.

Compliance

CE

AS/NZS

(Declarations of conformity available on request).

Care Instructions

All wooden and/or polycarbonate lights are intended for use in dry interior conditions only and can be cleaned with a soft cloth dampened slightly in warm water when the light is switched off. Do not use detergents.

Light sizes

David Trubridge kitset lightshades come in various sizes, making it easy to find the right size to any interior space whether it's small or large.

EPD Certified

An EPD is a standardised and verified way of quantifying the environmental impacts of a product, based on a consistent set of rules that have been developed through a stakeholder consultation process.

Warranty

This light is warranted for three years from date of purchase for failure of parts.



THE INTERNATIONAL EPD® SYSTEM

Technical Data

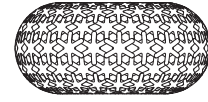
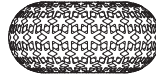

800mm/31"

1000mm/39"

1600mm/63"

	800mm/31"	1000mm/39"	1600mm/63"	
Dimensions	Width: 800mm / 31" Height: 400mm / 16" Weight: 1.7kg / 3.74lb	Width: 1000mm / 39" Height: 500mm / 20" Weight: 2.5kg / 5.51lb	Width: 1600mm / 63" Height: 700mm / 28" Weight: 11.2kg / 24.69lb	
Cordset*	2m / 6.5ft	2m / 6.5ft	5m / 16.4ft	
Material	Bamboo plywood (Sourced from FSC accredited factory)	Bamboo plywood (Sourced from FSC accredited factory)	Bamboo plywood (Sourced from FSC accredited factory)	
Fasteners	Nylon	Nylon	Aluminium	
Suspension	1 x Suspension Wire	1 x Suspension Wire	3 x Suspension Wires	
Packaging	470mm x 360mm x 80mm 19" x 14" x 3" 0.014m ³ / 0.478ft ³ 2.2kg / 4.85lb	530mm x 450mm x 80mm 21" x 18" x 3" 0.019m ³ / 0.674ft ³ 3.2kg / 7.05lb	1650mm x 1650mm x 850mm 65" x 65" x 33" 2.314m ³ / 81.723ft ³ 160kg / 352.74lb	

*Black comes with black cordset and fasteners. All others come with white cordset and clear fasteners. Custom lengths available on request.

You will need

Fixings for cone gripper (fixing screws NOT SUPPLIED).

Note: Choose appropriate hardware to attach base plate (Fig.1) to ceiling substrate.

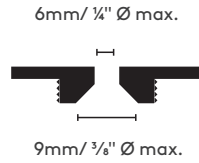
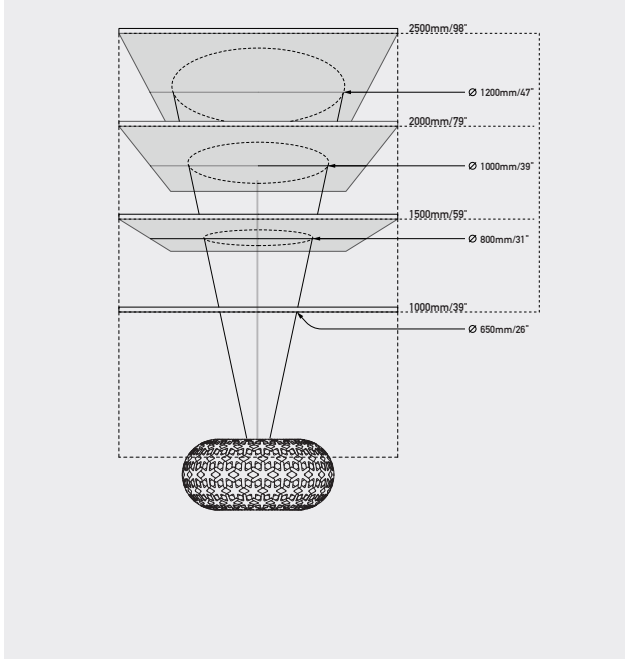

Fig 1. Base Plate

Installation 1600mm/63"



Step 1.

Decide upon hanging distance. Use the schematic diagram as a guide to pick a circle radius to be marked out on ceiling. This circle can be marked with a length of timber or string.

Installation - All sizes

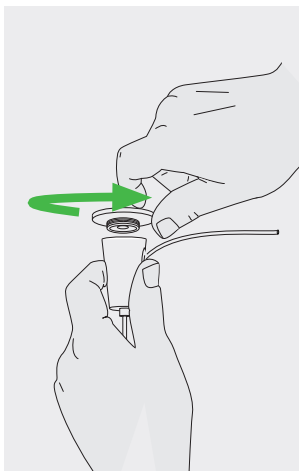

Step 1.

Unscrew baseplate.

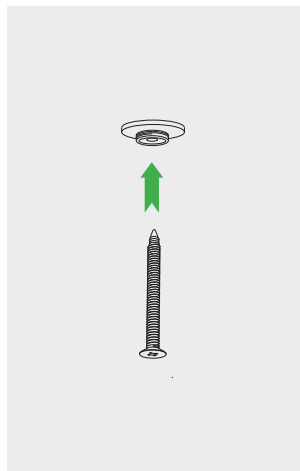

Step 2.

Use appropriate fixing screw to mount base plate (Fig.1).

Options

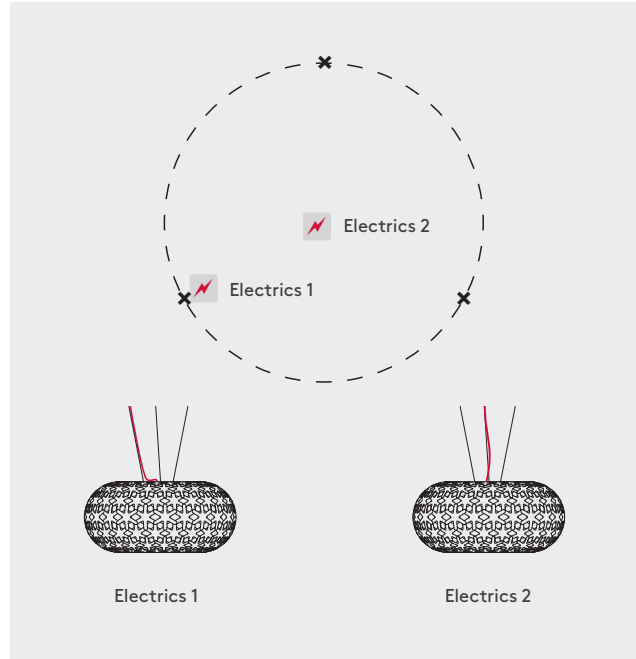

Step 2.

Mark 3 hanging points where your cone grippers will be located. You can either centrally locate the ceiling canopy or run the electric cord up one of the suspension wires.

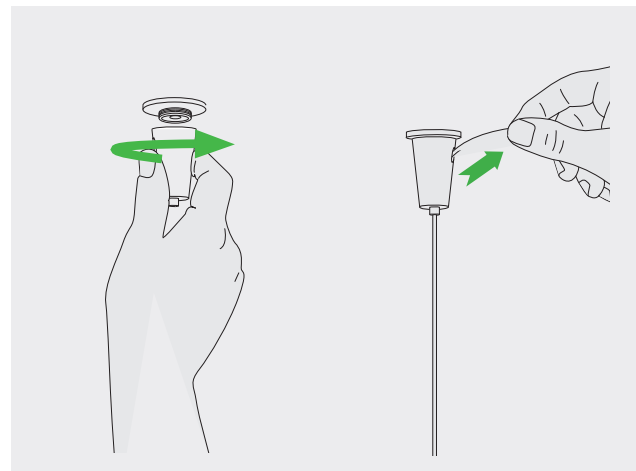

Step 3.

Remove cable from cone. Screw cone back onto baseplate. Re-insert cable and level light. Once desired position is set, trim excess cable.

Diagrams

800mm/31"
1000mm/39"

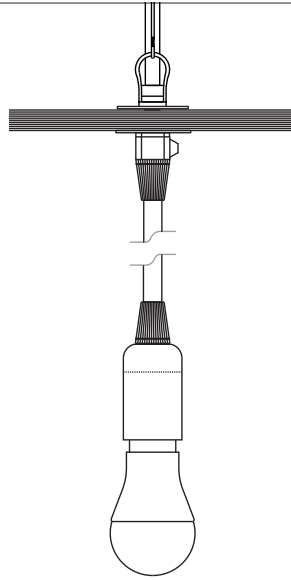

North America: E26, Max 60 Watts
120v AC 60hz
Rest of World: E27, Max 60 Watts
230-240v AC 50hz



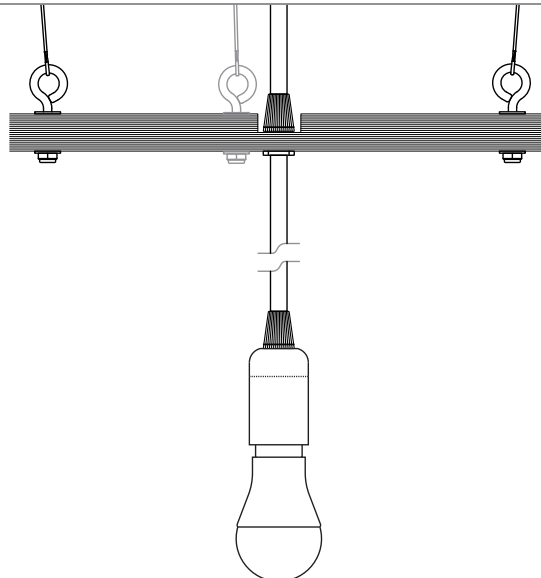



1600mm/63"





North America: E26, Max 60 Watts
120v AC 60hz
Rest of World: E27, Max 60 Watts
230-240v AC 50hz

David Trubridge PENDANT SERIES

 This luminaire is compatible with bulbs of the energy classes:

 A++
 A
 B
 C
 D
 E



874/2012 

Finish Choices



Bamboo

All bamboo (our primary material) is secondary product, from renewable forests in China grown as a food source. We have visited these plantations and are satisfied with the quality of their systems.

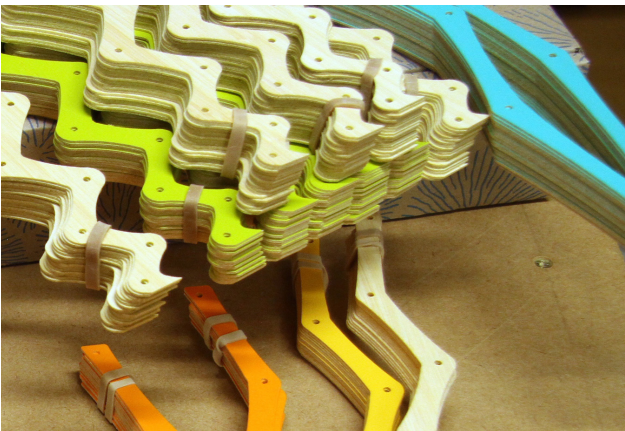

Painted Lights

We use an acrylic low VOC (volatile organic compound) paint that is made in New Zealand. Colour swatches are available in all retailers. See the Resene website for more info. www.resene.co.nz



Bamboo

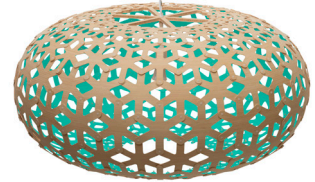

Aqua

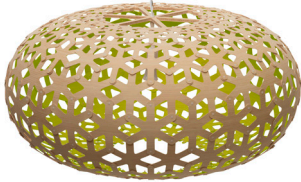

Lime

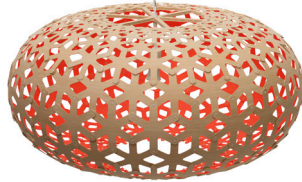

Red

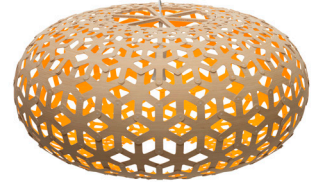

Orange

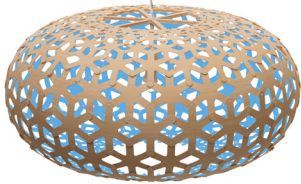

Blue



Pink



Black 1 Side (Outside)



Black 1 Side (Inside)



Black 2 Sides



White 1 Side



White 2 Sides



Contact

New Zealand
Showroom/Head office

Contact

+64 6 6500 204
info@davidtrubridge.com

Address

Corner Station Road &
Groome Place, Whakatu,
Hastings, Hawkes Bay,
New Zealand