

Halo

60 INCH VANITY UNIT
HAL008-60-PONY

Designed in Australia by Zuster, and is available exclusively at Reece USA.

The Halo vanity is inspired by fashion and three-dimensional movement of fabric pleats, crafted with precision and engineered to stand out. The triple drawer configuration with internal shelves features signature pleated timber paneling with Blum soft close runners, Midnight Quartz benchtop and matching Midnight Quartz handle. Made from American Oak, the suite creates a minimal outlook with intricate, delicate detailing to enhance the bathroom mood.



To see the complete range go to <https://reecebathandkitchen.com/collections>

About Zuster -

Inspired by Australian living, Zuster is Dutch for sister. Designed in Australia by an extraordinary duo Wilhelmina McCarroll and Fleur Sibbel, uniquely reimagining the bathroom space, Zuster is the ultimate representation of magnificence & detail, inspired by our surroundings. Bringing a modern Australian design approach to unlock the resurgence of American Oak. Inside and out, Zuster bathroom furniture has been impeccably designed through craft and refined finishing, making each piece a statement of glamour and luxury. Its magnetic beauty paired with macro detail makes Zuster one of a kind.

Disclaimer: Products in this specification manual must by regulation be installed by licensed and registered trade people. The manufacturer/distributor reserves the right to vary specifications or delete models from their range without prior notification. Dimensions are nominal measurements only. Dimensions and set-outs listed are correct at time of publication however the manufacturer/distributor takes no responsibility for printing errors.

Published 30/05/2023

Halo

60 INCH VANITY UNIT
HAL008-60-PONY

Standard Size

Width (inch)	60"
Depth (inch)	21 7/8"
Height (inch)	19"
Number of drawers	3
Sinks	2

Specifications

Recommended Use	Domestic, Hotel & Commercial
Vanity Cabinet Material	American Oak solid and veneer
Vanity Frame Material	Handcrafted mitrered frame in American Oak veneer with 2 Pack Polyurethane on High Moisture Resistant MDF
Door Design	Soft close drawers with Blum hinges
Benchtop Material	Midnight Quartz
Handles Material	Midnight Quartz
Vanity Finish	Pony Oak
Fixing	Bolted / Screwed to Wall by a Licensed Trades Person (not included) Please refer to the Installation instructions. Document on the Website for more information.
Designed in	Australia
Manufactured in	Vietnam

Cleaning Recommendations -

Our timber frame should be cleaned with a mild, non-acidic, non-abrasive detergent and soft cloth. Finish by cleaning off detergents with a soft damp cloth and towel dry. Always clean spills and water immediately.

Finishes -

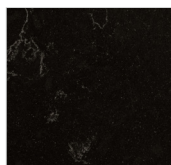

Midnight (Quartz)
Bench Top and Handle

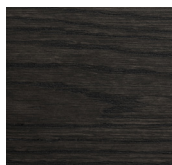

Pony Oak (American Oak)
Vanity Cabinet



High quality moisture resistant American Oak veneer and solid American Oak.

Halo

60 INCH VANITY UNIT
HAL008-60-PONY

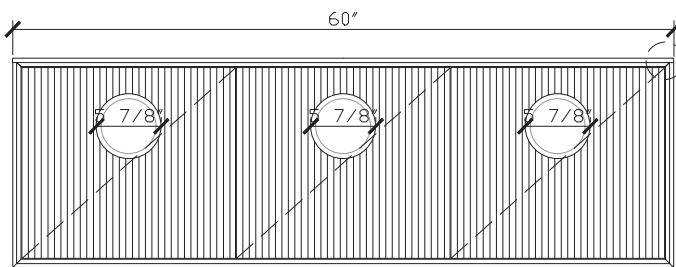

Front View

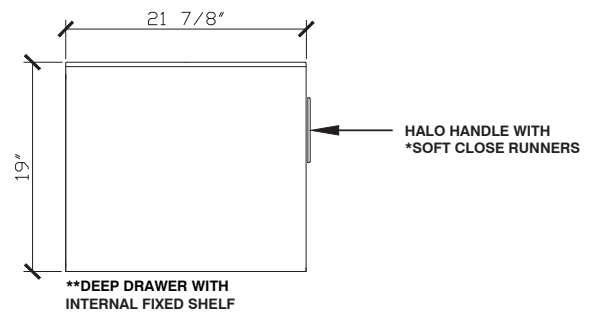

Side View

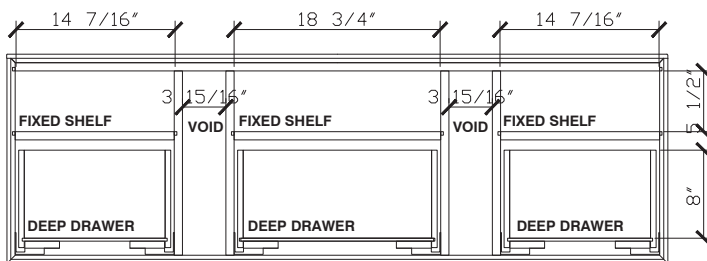

Internal Front View

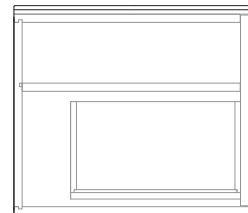

Internal Side View



Detail (bench top) Front View

Halo

60 INCH VANITY UNIT
HAL008-60-PONY

Waste and taphole cutout -

Sink: Kohler Vox vessel bathroom sink K-14800-0 - Sold Separately

Faucet: Dornbracht Meta Single-lever basin mixer with raised base without pop-up waste 33 534 661-33 - Matte Black - Sold Separately

Double sink **only**

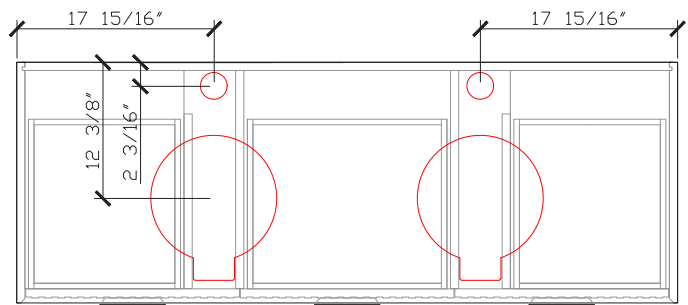

Waste Cutout Top View

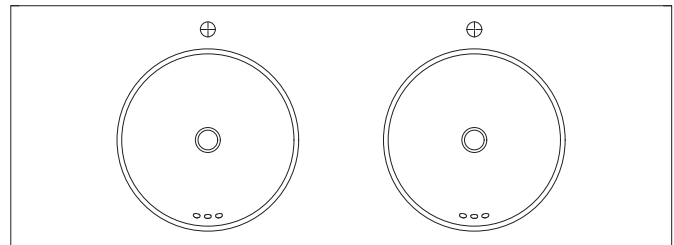

Basin Top View