

Your first choice of inverter brand

Pure sine wave inverter MANUAL

Your first choice of inverter brand

Safety Notice

In order to avoid damage to you and others, here we list below safety notice, please make sure to obey and refer for the following meaning of the marks



Warn/Note



The mark means
for prohibited item



The mark means
for mandatory item



When connect with the battery will produce spark, connect the former to ensure that no flammable gas. Battery charging, discharging will produce inflammable gases, should be well-ventilated, do not put in the place may accumulate flammable gases



Output can not be parallel with the mains
Will damage the inverter and the danger of electric shock



Minors can not use it
Output high voltage will cause
a danger of electric shock



When using this machine, please do not
bundle wires, Use the broken wire can
cause electric shock, short circuit of fire



Do not disassemble or remodel the inverter
Do not disassemble or remodel the inverter. Disassemble or modify unauthorized
inverter may cause a malfunction or fire, electric shock



Do not wet the airframe
Otherwise may lead to short circuit, even the fire and electric shock



Do not place rod or other metal objects at vent or other openings
This may touch on the internal components to cause electric shock or injury



Put the plug of load of equipment full insert into an electrical outlet
Failure to fully insert the plug socket, could lead to electric shock and overheating, even cause a fire accident.
Do not use a damaged plug or loosed outlet



Forbid wet hand
This may cause electric
shock, prohibit wet hands



KEEP AWAY FIRE
Do not let the volatile substances or combustible
material floating into the machine, away from
the flame



Do not damage output sockets or wires
do not cut, remodel, close to the heat, over-distorted, reversed, wiring and pull wires,
or placed outlet weight on wires or sockets



WARN



Use inverter in common ground wire power system
If the output connect with the ground will cause inverter to short circuit and damage, for
example: used in the car, the inverter's output terminal has the voltage reflected on the
car body.



In power, do not let the load and to type in the loop
Cause the overload protection circuit will invalidate or increase the overload protection
power



Do not install inverter worked in hot, humid environment
Inverter leakage may cause electric shock or fire caused by accident



The inverters have not been tested for used in medical equipment



ATTENTION

In connection cable should be used to install the appropriate cable, if the AC output
cable is too long or the wire cross-sectional area is too small, will generate a large number
of cable power loss, the load performance will be low power and low voltage.
If battery and inverter connection cable are not standardized, too long cable, too small
cross-sectional, parts of contact too short, the inverter may not work but give an alarm,
meanwhile cable must have waterproof, insulate strength to meet environment requires.

Operation tips

Rated current and the actual used equipment
The nominal current or power of most of electromotive tools, household appliances and
audio-visual equipment, in the range of nominal power or much lower, but when they
startup it will occur overload protection phenomenon. Inverter is most likely to drive
resistive loads and switching power supply load, because the resistive load is linear load
that can be work with full load. Such as electric stove, rice cooker, LCD TV and other devices.
Some audio-visual equipment and electromotive tools need more power than the resistive
load to work normally, an asynchronous motor, CRT TV, compressors, pumps and so on.
They need 2 to 6 times of the operating current to start. Whether it can run a specific load
depend on the subject test.

 Note: continuous frequently on and off the inverter may cause the damage.

Applied to the following products:

For lamp, electric cooker, desktop computer, notebook computers, computer monitors, fax, printers, LCD Tv, Fan, DVD, mobile phones, digital products, drill machine, electric irons, washing machines and other original equipment usable electricity.

Introduction of performance

Inverter is a power equipment that can change DC (storage battery, solar cells, wind dynamo, etc.) to AC. The inverter use high-frequency power conversion technology, and use the ferrite transformer instead of the old bulky silicon steel transformer. That is why our power inverter is lighter, smaller than other similar inverter. When the inverter working in inversion mode, the output waveform is sine wave. Pic 1: Output sine wave form

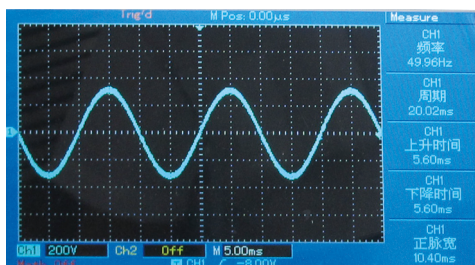

Environment for use

In order to get the best using results, please put the inverter on the flat surface, such as the ground, car floor, or other solid surface which can easily fixed the inverter's power cord.

The working place should meet the following criteria:

Keep dry, should not let the inverter contact the water or other liquids, keep the inverter away from moisture or water.

Cool environment, keep the temperature between 0 Celsius degrees (no condensation) and 40 Celsius degrees.

Do not put the inverter next to heat vents or other heat devices. Try to keep the inverter not be shined directly by the sunshine.

Ventilation. No objects block around, and keep free flow of the air. Do not put anything on the inverter when it was working.

Installing and using method

300W-2500W

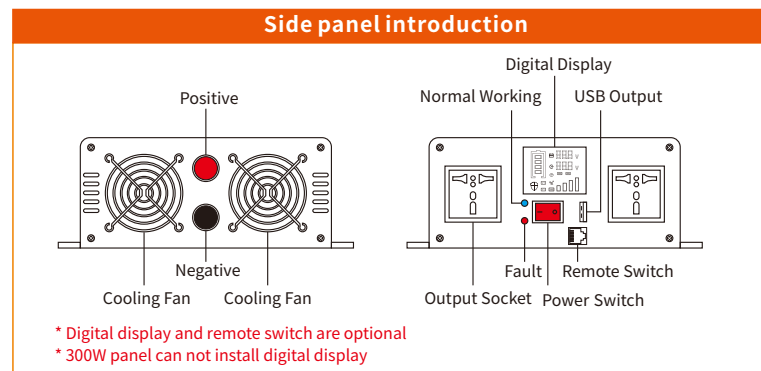

3000W-8000W

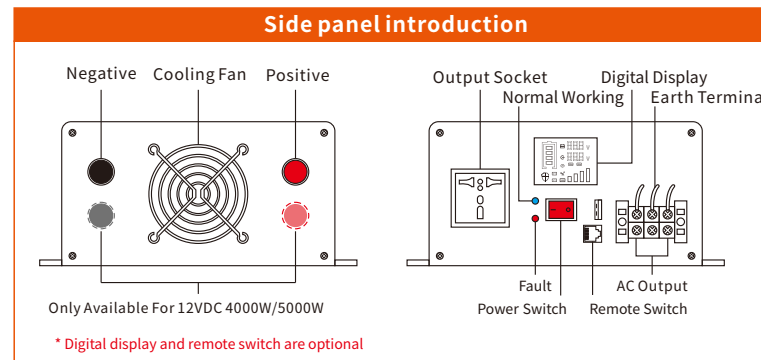

The output socket type can be customized according to customer's demand

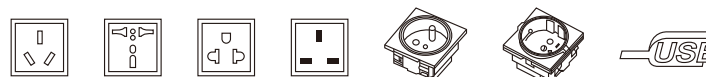

Installing and using method

500-2500W With charger / UPS

Side panel introduction

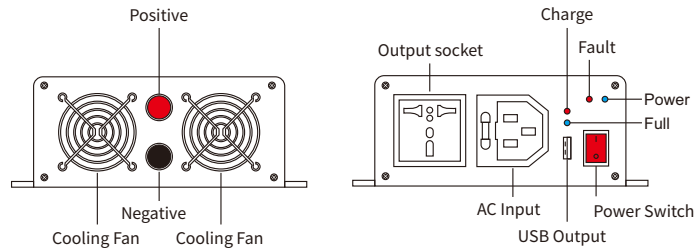

3000-5000W With charger / UPS

Side panel introduction

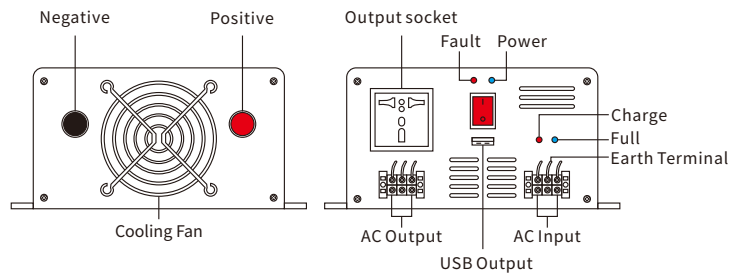

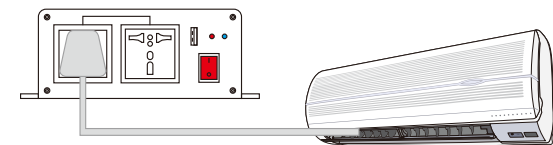
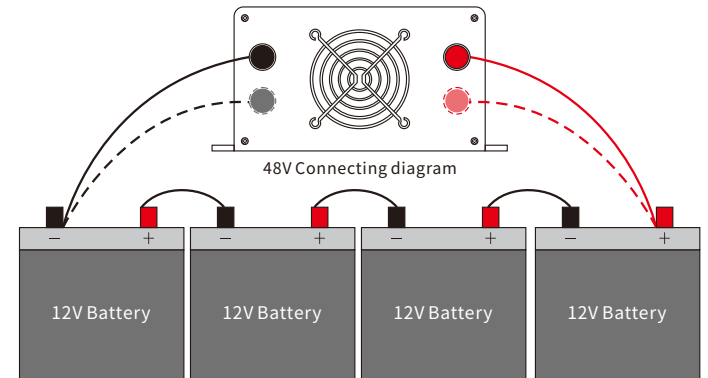
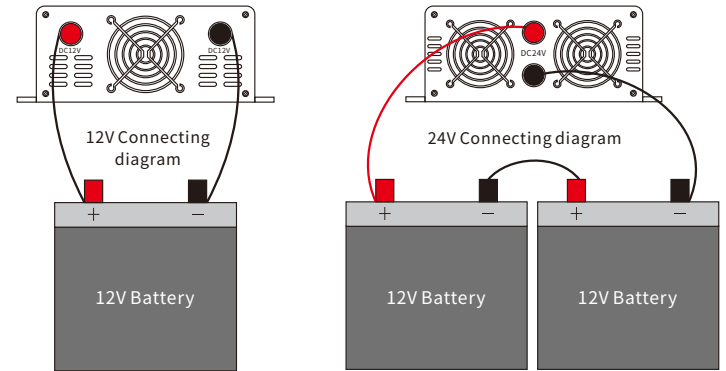

Connecting diagram



Optional Parts

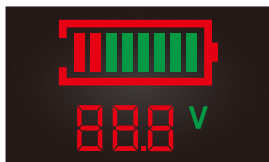







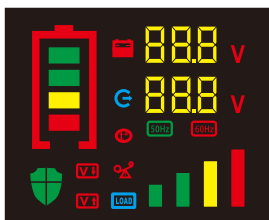



Display of D model



-  Battery Level
-  Battery Voltage



Display of E model

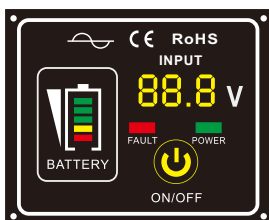

-  Power On
-  Battery Connected
-  Battery Level
-  Battery & AC Output Voltage
-  Frequency
-  Output Load Percent
-  Inverter Normal Working
-  Inverter Under Protection
-  Inverter Over Voltage Protection
-  Inverter Overload Protection
-  Inverter Over Temperature Protection
-  Inverter Low Voltage Protection

Remote switch



-  Battery Level
-  Battery Voltage
-  Power Switch

- * Before using remote switch, please turn the inverter switch to OFF status
- * When using the remote switch, the inverter power switch will be out of work

Installation connection steps: please refer to the above connection diagram

1. First of all, turn off the inverter power.
2. Use the black DC cable to connect the negative terminal of the battery and the black post head of the inverter.
3. Use the red DC cable to connect the anode terminal of the battery and the red post head of the inverter.
4. Make sure the DC cable size is big enough, or else the inverter may fail to run the equipment.
5. Don't use DC cable too long length, or else the inverter may fail to run the equipment.
6. Plug the power plug of the equipment in the inverter's output socket.
7. Press the inverter's switch then it can be used.

With grid charger and UPS function:

1. Don't connect the grid power with AC output of the inverter, or it may destroy the inverter PCB;
2. Grid mode: When connected the grid power with AC Input plug or terminal, the AC output socket and terminal will output grid power as first priority;
3. Battery mode: When disconnecting the grid power from inverter AC input, the AC output socket and terminal will output power from battery automatically as second priority;
4. The switch time from grid to battery and battery to grid is 4-6ms.
5. In grid mode, the inverter will charge the battery in the mean time, with 3-step charging way.
6. When battery is in charging, the Charging red-led will be on, when battery is fully charged, the charging red-led will be off, and Full blue-led will be on.

With bypass function(without grid charger):

1. Grid as first priority: the inverter will output grid power as first priority, when grid disconnected, the inverter will switch to battery power automatically.
2. Battery as first priority: the inverter will output battery power as first priority, when battery disconnected, the inverter will switch to grid AC power automatically.

Pure sine wave inverter

Dismantle steps:

- 1.First of all, turn off the inverter power.
- 2.Disconnect the power plug.
- 3.Dismantle the red DC cable.
- 4.Dismantle the black DC cable

Notes: The connecting diagram is just as basic reference, please contact with the professional technical personnel for the actual installing.

Inverter can use one or more batteries. Use of 100AH or larger battery is best.

Notes: The inverter required to connect the same voltage battery, 12V inverter to 12V battery, 24V inverter to 24V battery.

When switch on the power inverter, if blue led indicator is on, it means the inverter works well.If the red light is on, this is to protect the inverter. Should find a way to solve before use it (check the battery voltage is too high or too low, the inverter output is overloaded or short circuit).

Specification

Rated Power	300W	500W	1000W	1500W	2000W	2500W	3000W	3500W	4000W	5000W	6000W	8000W
Surge	600W	1000W	2000W	3000W	4000W	5000W	6000W	7000W	8000W	10000W	12000W	16000W
Input Voltage	12/24/48VDC											
Output Voltage	120/230VAC											
USB Port	5VDC											
Frequency	50/60Hz											
Output Wave	Pure Sine Wave											
Soft Start	Yes											
AC Regulation	THD 3%(Linear Load)											
Efficiency	94% MAX											
Cooling Way	Intelligent Cooling Fan											
Protection	Battery Low Voltage & Over Voltage, Over Load, Over Temperature, Short Circuit											
Working Temperature	-10 ° C to 50 ° C											

Maintenance Record

Dear user, thank you selecting our product.
Please fill in and keep the warranty card for better services.

Attn: _____ Product Number: _____

Tel: _____ Fax: _____

Purchase date: _____

Address: _____

Maintenance Record			
Date of repair	Content	Maintenance Personnel	Note