



CHEF BASES



Features

- CFC free refrigerant and foam insulation
- Electronic thermostat and digital LED temperature display for accurate control and easy reading
- Easy to mount 4" casters (two lockable in front) are standard with all units
- Magnetic gasket can be replaced without any tools
- Stainless steel framework construction
- Auto defrosting and auto evaporation of condensation water
- 4" PC pans not included. Note: this unit cannot accommodate 6" PC pans.
- Raised marine edge contains spills
- Exterior: 430 stainless steel top, front & sides. Aluminum back panel.
- Interior: Aluminum with a 304 stainless steel floor
- Temperature: 33 to 41°F / 0.5 to 5°C
- Electrical: 115/60/1 with NEMA 5-15P plug

Specifications

MODEL	DRAWERS	EXT DIMENSIONS W x D x H	AMPS	H.P.	SHIP WEIGHT
KCBR-48	2	50 x 31.9 x 26	5.8	1/3	162 lbs
KCBR-60	2	62 x 31.9 x 26	5.8	1/3	200 lbs
KCBR-72	4	74 x 31.9 x 26	5.8	1/3	232 lbs

Options

See page 34 for pan configurations for units.

CERTIFIED TO ANSI/NSF-7 STANDARDS



5659 Royalmount Ave.
 Montreal, QC, Canada H4P 2P9
 Telephone: 514.737.9701 / Toll Free: 888.275.4538
 Fax: 514.342.3854 / Toll Free: 877.453.8832
 sales@mvpgroupcorp.com / mvpgroupcorp.com

12000 Biscayne Blvd., Suite # 108
 Miami, FL, United States 33181
 Telephone: 786.600.4687 / Toll Free: 844.218.8477
 Fax: 786.661.4100



CHEF BASES

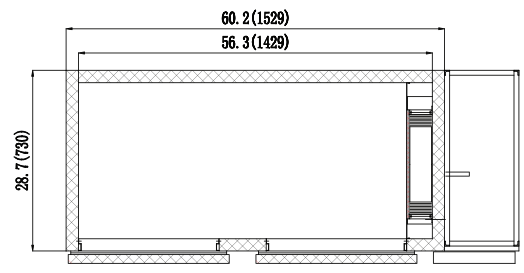
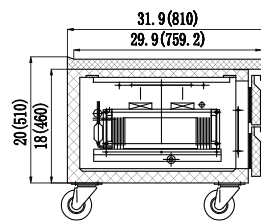
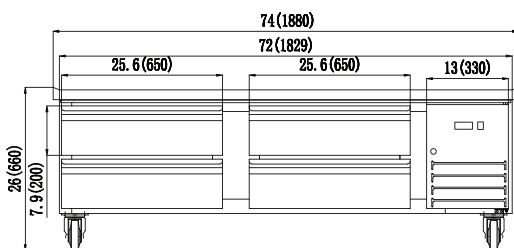
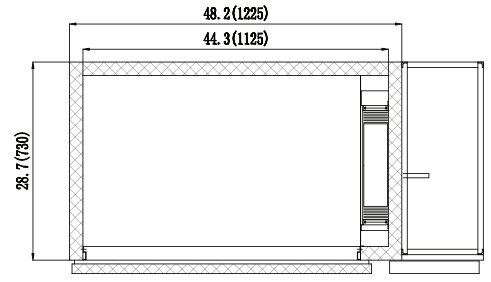
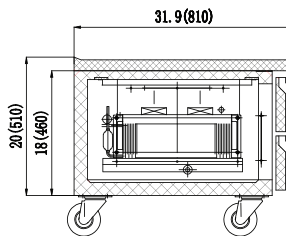
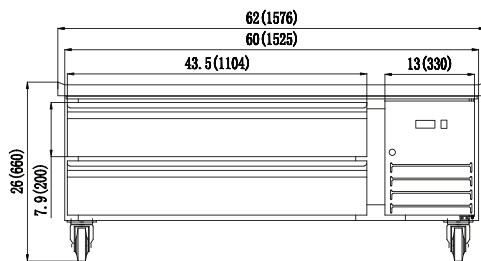
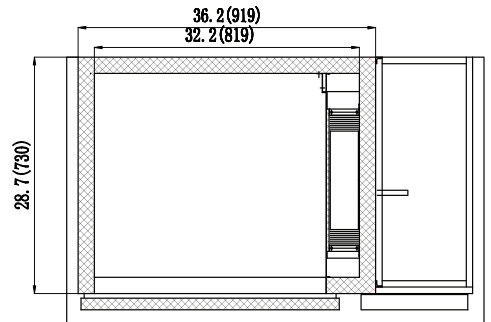
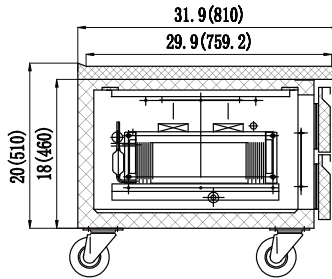
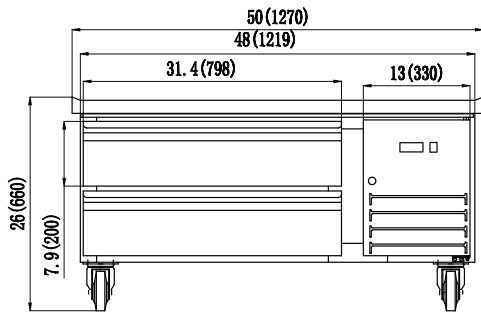

Dimensions in inches (mm)

CERTIFIED TO ANSI/NSF-7 STANDARDS



Intertek

Intertek



5659 Royalmount Ave.
 Montreal, QC, Canada H4P 2P9
 Telephone: 514.737.9701 / Toll Free: 888.275.4538
 Fax: 514.342.3854 / Toll Free: 877.453.8832
 sales@mvpgroupcorp.com / mvpgroupcorp.com

12000 Biscayne Blvd., Suite # 108
 Miami, FL, United States 33181
 Telephone: 786.600.4687 / Toll Free: 844.218.8477
 Fax: 786.661.4100