



# OWNER'S MANUAL

## DISHWASHER INSTALLATION AND MAINTENANCE

F14

F16

F18

F20

F22

727

737

747

767

For operator. Do not discard.



**Welcome to JET-TECH**  
***“Creating endless possibilities!”***

*We have included information to help troubleshoot problems and facilitate resolving those problems. General information pertaining to our hi-temp ware washers will be covered in this manual. Specific information on our current and older models is available upon request, model by model.*

*If you find any discrepancy or can't find certain information, please contact us. We will be glad to be of assistance.*

**MVP GROUP CORPORATION**  
**JET-TECH SYSTEMS**  
5659 Royalmount Avenue  
Montreal, Quebec H4P 2P9  
Tel.: 888-275-4538 (888-ASK-4-JET); 514-737-9701  
Fax: 877-452-8832; 514-737-2792  
E-mail: [service@jet-tech.com](mailto:service@jet-tech.com)

Contents

WARRANTY.....4  
MACHINES SPECS.....5  
GENERAL INSTALLATION GUIDELINES.....6  
CONNECTING YOUR F-14.....7  
CONNECTING YOUR F-16.....8  
CONNECTING YOUR F-18.....9, 10  
CONNECTING YOUR F-20.....11  
CONNECTING YOUR F-22.....12, 13  
CONNECTING YOUR 727.....14  
CONNECTING YOUR 737.....15  
CONNECTING YOUR 747.....16  
CONNECTING YOUR 767.....17  
CHEMICAL PUMP ADJUSTMENT.....18, 19  
CONTROL PANELS.....20  
BASICS STEPS TO START.....21  
OPERATION.....22, 23  
F18, BASICS STEPS TO OPERATE.....24  
F22, BASICS STEPS TO OPERATE.....25  
DRAIN PUMP OPERATION.....26  
PROBLEM ANALYSIS.....27, 28, 29, 30  
HELP LINE.....31



## MANUFACTURERS LIMITED WARRANTY

MVP GROUP CORPORATION (Jet-Tech Systems) hereby warrants all new warewashers bearing the name "JET-TECH" and installed within the continental United States of America or Canada to be free from defects in material and workmanship, under normal and regular usage and operation, for a period of one (1) year following the date of original installation (**unless specified otherwise**) but in no event can exceed eighteen (18) months from the date of shipment from the factory.

This warranty is valid **ONLY** for the original owner of the "Jet-Tech" unit and is not transferrable.

If a defect in material(s) or workmanship is detected or found to exist within the above stated period, MVP Group Corp., at its sole discretion, shall either repair or replace any original equipment manufacturers part which has proven to fail within the machine, providing that the equipment has not been altered or tampered with in any manner, has been installed correctly as per the owner's manual and maintained and operated in complete accordance with this manual.

The labor cost to repair or replace any part proven to be defective, as per above clause(s), shall be covered by MVP Group Corp., within the continental United States of America or Canada provided that prior authorization for this labor was approved by MVP Group Corp., the service work was performed by an authorized MVP Group Corp., service agency and that this agency installed an original and genuine Jet-Tech part in the machine. Any repair work performed by a non-authorized service depot remains the sole responsibility of the user and MVP Group Corp., will not be held responsible. **The installation of any generic part will not be valid and therefore voids this warranty.** All authorized labor coverage shall be limited to regular hourly rates only. Any supplemental hourly rates or charges, such as weekends, holidays or emergency premiums remain the responsibility of the user.

MVP Group Corp., (Jet-Tech) hereby states that warranty travel time shall be limited to and without exception, a round-trip total of two (2) hours OR mileage up to a maximum of one hundred (100) miles (160 KM) round-trip. Any charges exceeding those stated herein must have prior authorization by the factory or will be at the customer's expense.

**Exceptions to above warranty are:** (A) Damages resulting from shipping, handling or abuse. (B) Incorrect installation and/or connections. (C) Adjustments or calibration of any parts. (D) Faults due to lack of regular maintenance or cleaning of any internal part(s). (E) Replacement of any wearable items such as peristaltic squeeze tubing or gaskets. (F) Excessive lime, mineral, alkali or hard water conditions (In excess of 6 grain) and (G) Poor results due to use of an incorrect type of detergent or rinse additive (for non-commercial type applications or products containing chlorine) and excessive or inadequate water temperature(s) or pressure conditions or incorrect use.

MVP GROUP CORPORATION STATES THAT THERE ARE NO OTHER WARRANTIES, EXPRESSED OR IMPLIED, THAT ARE NOT SET FORTH HEREIN, MVP GROUP CORPORATION SHALL ASSUME NO OTHER RESPONSIBILITY, EITHER DIRECT OR NON - DIRECT OR BE LIABLE FOR ANY OTHER OR ADDITIONAL LOSS OR DAMAGE WHETHER BEING DIRECT OR CONSEQUENTIAL, AS A RESULT OF ITS EQUIPMENT.



**Warranty:** *One year parts & labor (Continental USA and Canada).*

**Exceptions:** *Model "F-14" - 90 days labor & One year parts.*

*The manufacturer reserves the rights to alter design and specifications without notice.*

# JET TECH - Technical Data

description voltage maximum absorption washing pump motor drain pump motor booster element tank element Amp	<b>F 14</b>	110V 60 Hz 1475 W 75 W 1400 W 1400 W 13.4	<b>F 16</b>	220V 60 Hz 2600 W 184 W 100 W 2400 W 2000 W 12.9	<b>F 18</b>	220V 60 Hz 4550 W 550 W 100 W 4000 W 2800 W 22.2	<b>F 18 DP</b>	220V 60 Hz 4650 W 550 W 100 W 4000 W 2800 W 22.4	<b>F 20</b>	220V 60 Hz 6750 W 1100 W 6000 W 4000 W 31.5	<b>F 22 1PH</b>	220V 60 Hz 9750 W 750 W 9000 W 6000 W 46.9			
	Hydraulic data solenoid valve capacity booster capacity tank capacity water consumption water pressure water connection water drain	2.6 GAL/minute .66 U.S. GAL 2.4 US GAL .522 US GAL 30 PSI 3/4" NPT diam. 1"	2.6 GAL/minute .84 US GAL 3.2 US GAL .522 US GAL 30 PSI 3/4" NPT diam. 1"	2.6 GAL/minute 2.05 U.S. GAL 6.8 US GAL .67 US GAL 30 PSI 3/4" NPT diam. 1"	2.6 GAL/minute 2.05 U.S. GAL 6.8 US GAL .67 US GAL 30 PSI 3/4" NPT diam. 1"	2.6 GAL/minute 2.7 U.S. GAL 7.9 US GAL .8 US GAL 30 PSI 3/4" NPT diam. 1.5"	3.7 GAL/minute 2.7 U.S. GAL 5 US GAL 1.1 US GAL 30 PSI 3/4" NPT diam. 1.5"								
		Dimensions high length deep weight	650 mm 630 mm 600 mm 35 Kg.	724 mm 480 mm 510 mm 44 Kg.	840 mm 600 mm 600 mm 68 Kg.	840 mm 600 mm 600 mm 68 Kg.	1300 mm 640 mm 650 mm 90 Kg.	1545 mm 1210 mm 720 mm 180 Kg.							
			description voltage maximum absorption washing pump motor drain pump motor booster element tank element Amp	<b>F 22 3 PH</b>	220V 60 Hz 9750 W 750 W 9000 W 6000 W 33.9	<b>727</b>	220V 60 Hz 3050 W 550 W 100 W 2400 W 2000 W 14.2	<b>737</b>	220V 60 Hz 4650 W 550 W 100 W 4000 W 2800 W 22.4	<b>747 1 PH</b>	220V 60 Hz 10100 W 1100 W 9000 W 6000 W 48.6	<b>747 3 PH</b>	220V 60 Hz 10100 W2 1100 W 9000 W 6000 W 35.1	<b>767</b>	220V 60 Hz 11550 W 2210 W 9000 W 9000 W 40.1
				Hydraulic data solenoid valve capacity booster capacity tank capacity water consumption water pressure water connection water drain	3.7 GAL/minute 2.7 U.S. GAL 5 US GAL 1.1 US GAL 30 PSI 3/4" NPT diam. 1.5"	2.6 GAL/minute .84 U.S. GAL 2.1 US GAL .522 US GAL 30 PSI 3/4" NPT diam. 1"	2.6 GAL/minute 2.05 U.S. GAL 3.15 US GAL .74 US GAL 30 PSI 3/4" NPT diam. 1"	3.7 GAL/minute 2.7 U.S. GAL 4.75 US GAL 1.1 US GAL 30 PSI 3/4" NPT diam. 1.5"	3.7 GAL/minute 2.7 U.S. GAL 4.75 US GAL 1.1 US GAL 30 PSI 3/4" NPT diam. 1.5"	3.7 GAL/minute 2.7 U.S. GAL 6.6 US GAL 1.3 US GAL 30 PSI 3/4" NPT diam. 1.5"					
					Dimensions High length deep weight	1545 mm 710 mm 720 mm 140 Kg.	820 mm 500 mm 510 mm 140 Kg.	850 mm 600 mm 600 mm 68 Kg.	1445 mm 710 mm 720 mm 140 Kg.	1445 mm 710 mm 720 mm 140 Kg.	1900 mm 900 mm 900 mm 220 Kg.				

## General Installation Guidelines

The unit must be installed on a level surface or allow for easy leveling of the unit. It must be installed on a non-combustible surface.

All body panels must remain on the equipment when the installation is completed. This instruction Manual must remain with the operator.

### Electrical

- Based on the local electrical code, wires must be large enough to carry the electrical load used by the dishwasher. Please check the rating plate on the unit for power requirements and breaker size.
  - All units must be grounded.
  - Except for model F-14 (110 volts), all the high-temp dishwashers do NOT require a neutral.
  - For Tri-phase models, three live wires are required.
- IMPORTANT:** The rotation of the pump(s) must be verified at time of install.
- Only a licensed electrician is recommended to install the warewasher according to local codes.

### \*\*Water supply\*\*

- A supply of 140°F water is required. If water temperature is below 140°F, the dishwasher must be allowed extra time between washes.

- Running (flow) pressure must be 30 PSI.

A Pressure Reducing Valve (not included) is required for installations with water pressure greater than 30 PSI and must be installed upstream of the pressure gauge.

- Water should be free of minerals and other sediments.

- A 3/4" NPT metal braided hose of sufficient length &

flexibility is supplied to permit the machine to be moved for cleaning or maintenance. Hard plumbing is not recommended. The solenoid valve inline filter must be checked monthly and cleaned as required.



### \*\*Drain connection\*\*

- A drain hose of sufficient length & flexibility is supplied to permit the machine to be moved for cleaning or maintenance. Hard plumbing is not recommended.

- If the unit uses a gravity drain, it has to drain in an open floor drain.

- Do not reduce the drain hose size.

- Follow local codes for proper waste disposal.

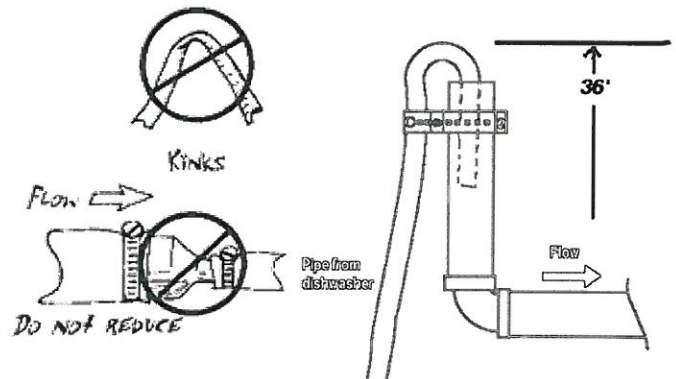

**\*\* Water, waste piping and connections shall comply with the International Plumbing Code, International Code Council (ICC) or the Uniform Plumbing Code, International Association of Plumbing and Mechanical Officials (IAPMO) \*\***

## Connecting your new F-14

This dishwasher must be installed on a level, rigid, nonflammable surface. Ensure that the machine is level by installing the feet (shipped in the wash tank of the machine) and adjusting the leveling. Be sure to provide adequate space for water, drain and electrical connections. The rear panel must be removed for the hook ups and must be replaced after the connections are made.

### ELECTRICAL SUPPLY

A 115 Volt - 20 Amp circuit breaker is required for this washer. A power-cord with NEMA 5-20 plug is provided for your convenience.

### \*\*WATER SUPPLY\*\*

A 3/4" NPT coupling is required with 30 psi. dynamic pressure. A water pressure regulator\* may be required. The water pressure cannot be less than 30 psi or exceed 30 psi. If the water pressure exceeds the prescribed amount, you will get inconsistent washing temperature, premature failure and thus may void the warranty.

Incoming water temperature must be 140° F (60° C). An easily accessible shut-off valve is recommended, making installation, service and maintenance easier.

A flexible fill hose is provided to make installation, servicing and maintenance easier.

Make sure that the water is free from calcium and hard water deposits. For these situations, an inline water cartridge system is highly recommended. Build-up of calcium and lime deposits in the washer may occur and servicing will be required on a more frequent basis which will not be covered by the warranty.

### \*\*DRAIN CONNECTION\*\*

This washer has a gravity type drain. Since this unit is a "Counter-Type" installation, the flexible drain hose provided should be connected to the drain outlet elbow at the rear of the unit behind the rear access panel; and extended through the side opening directly into a floor drain or sink (see Figure )

All panels must be replaced on the unit when the installation is completed.

**DO NOT** manually fill wash tank with water. The dishwasher will fill automatically when the power is turned ON.

\* - not supplied

**\*\* SEE PAGE 6 FOR FURTHER IMPORTANT DETAILS\*\***

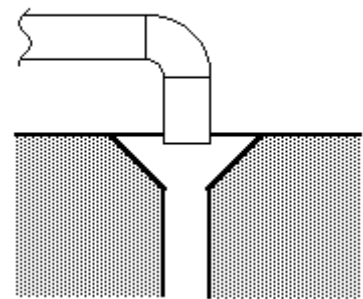
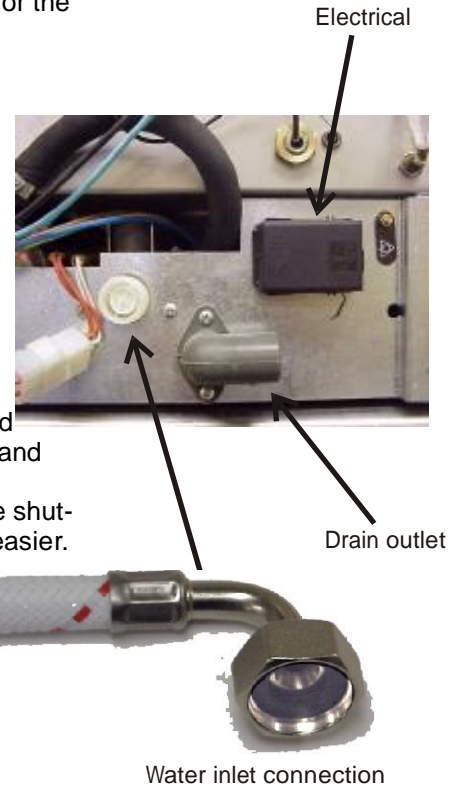

## Connecting your new F-16DP

This glasswasher must be installed on a level, rigid, nonflammable surface. Ensure that the machine is level by installing the feet (shipped in the wash tank of the machine) and adjusting the leveling. Be sure to provide adequate space for water, drain and electrical connections.

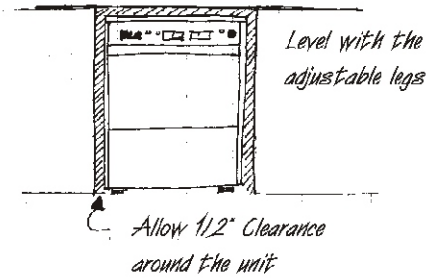

### **\*\*WATER SUPPLY\*\***

A 3/4" NPT fitting is required with 30 psi. dynamic pressure. A water pressure regulator\* may be required. The water pressure cannot be less than 30 psi or exceed 30 psi. If the water pressure exceeds the prescribed amount, you will get inconsistent washing temperature, premature failure and thus may void the warranty.

Incoming water temperature must be 140°F (60°C). An easily accessible shut-off valve is recommended, making installation, service and maintenance easier. A flexible fill hose is provided to make installation, servicing and maintenance easier.

Make sure that the water is free from calcium and hard water deposits. For these situations, an inline water cartridge system is highly recommended. Build-up of calcium and lime deposits in the washer may occur and servicing will be required on a more frequent basis which will not be covered by the warranty.



### **\*\*DRAIN\*\***

F-16 DP: This glasswasher is equipped with an automatic drain pump that will pump the drain water to a maximum height of 36" (0.9 meter). Drain pump equipped machines have a white button on the control panel beside the green power button.

1" ID flexible drain hose is provided to facilitate maintenance and servicing of the machine. It is important not to reduce the size of this hose. A 1" check-valve\* may be required.

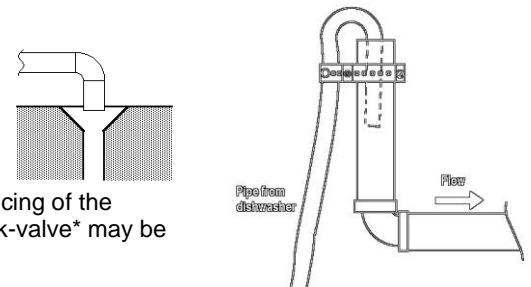

### **ELECTRICAL**

A 208-240 volt, 60 Hz, Single Phase circuit is required for this unit. Check the rating plate on the machine for amp draw. In spite of the fact that the rating plate shows 208 volts, the unit is designed function properly on 208 volts to 240 volts.

The terminal block is located at the back of the machine. Open the plastic cover, pass the cable through the cable strain relief and connect the wires to the L1, L2 & Ground. There should be sufficient cable length to permit the machine to be pulled out for service. DO NOT turn on the power to the machine until the water supply & drain lines have been connected. DO NOT manually fill wash tank. It will fill automatically.

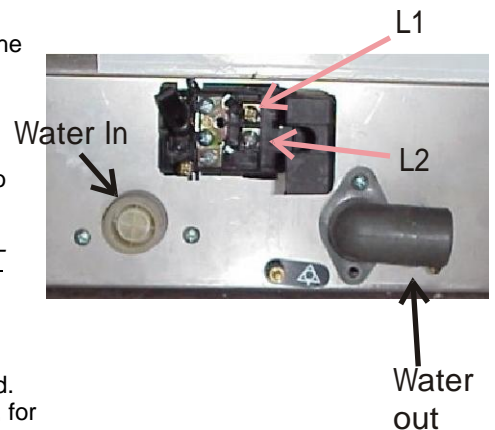

### **IMPORTANT NOTE**

Reasonable access to and around the machine for service must be provided. Disconnecting of hard plumbing or removal of counter tops or cabinets, etc., for servicing is not covered by warranty.

\* - not supplied

All panels must be replaced on the unit when the installation is completed.

\* - not supplied

**\*\* SEE PAGE 6 FOR FURTHER IMPORTANT DETAILS\*\***



## Connecting your new F-18, F18DP

This dishwasher must be installed on a level, rigid, nonflammable surface. Ensure that the machine is level by installing the feet (shipped in the wash tank of the machine) and adjusting the leveling. Be sure to provide adequate space for water, drain and electrical connections.



### **\*\*WATER SUPPLY\*\***

A 3/4" NPT fitting is required with 30 psi. dynamic pressure. A water pressure regulator\* may be required. The water flow pressure cannot be less than 30 psi or exceed 30 psi. If the water pressure exceeds the prescribed amount, you will get inconsistent washing temperature, premature failure and thus may void the warranty. Incoming water temperature must be 140° F (60° C). An easily accessible shut-off valve is recommended, making installation, service and maintenance easier.

A flexible drain hose is provided to make installation, servicing and maintenance easier. Make sure that the water is free from calcium and hard water deposits. For these situations, an inline water cartridge system is highly recommended. Build-up of calcium and lime deposits in the washer may occur and servicing will be required on a more frequent basis which will not be covered by the warranty.

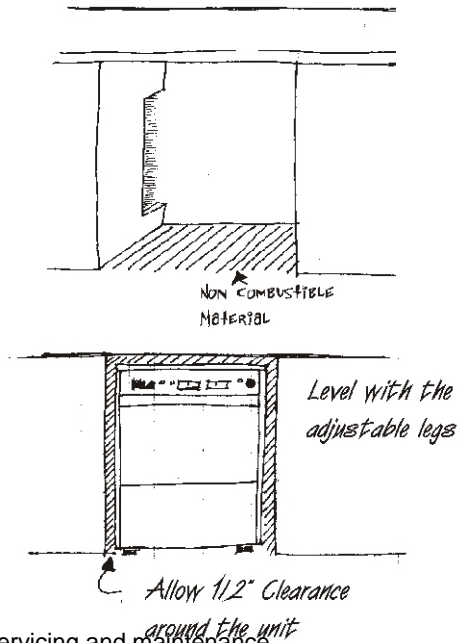

### **\*\*DRAIN\*\***

- F-18: This dishwasher has a gravity drain. Maximum height of the floor drain should not exceed 6" (15cm). A 1.5" ID flexible drain hose is supplied to facilitate maintenance and servicing of the machine.
- F-18 DP: This dishwasher is equipped with an automatic drain pump that will pump the drain water to a maximum height of 36" (0.9 meter). A 1" ID flexible drain hose is supplied to facilitate maintenance and servicing of the machine. It is important not to reduce the size of this hose. A 1" check-valve\* may be required on

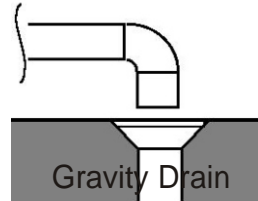

drain pump equipped models. Drain pump equipped machines have a white button on the control panel beside the green power button. Conversion from gravity to "DP" is not possible in the field.

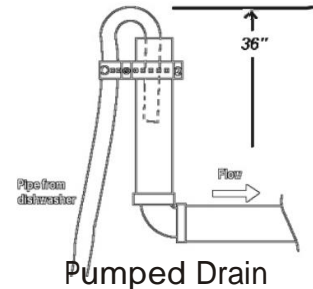
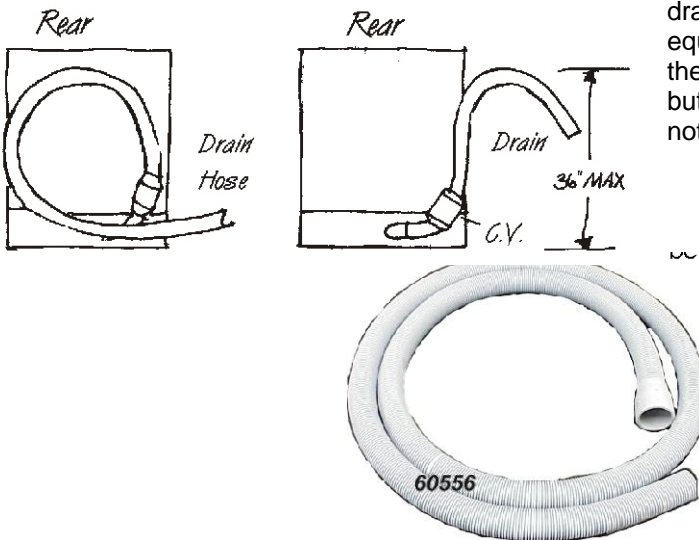

\* - not supplied

\*\* SEE PAGE 6 FOR FURTHER IMPORTANT DETAILS\*\*

## Installation F-18 , continued

### ELECTRICAL

A 208-240 volt, 60 Hz, Single Phase circuit is required for this unit. Check the rating plate on the front of the machine for the amp draw. In spite of the fact that the rating plate shows 220 volts, the unit is designed function properly on 208 volts to 240 volts.

The top & back panels must be removed for the electrical hook -up. The top panel is secured by two Phillips head screws. Once the screws are removed, the panel should be slid to the back and lifted. The back panel is also held by two screws. Remove them, pull the bottom away from the machine and lift the panel.

The terminal block is located inside the back cover. Pass the cable through the cable strain relief and connect the wires to the terminals **L1** (brown wire), **L2** (blue wire) & Ground (yellow & green wire). Replace the top & back panels being careful not to pinch or kink any wires or hoses. There should be sufficient cable length to permit the machine to be pulled out for service.

### IMPORTANT NOTE

Reasonable access to and around the machine for service must be provided. Disconnecting of hard plumbing or removal of counter tops or cabinets, etc., for servicing is not covered by warranty.

DO NOT fill dishwasher manually with water. The dishwasher will fill automatically when the power is turned on.

All panels must be replaced on the unit when the installation is completed.

\* - not supplied

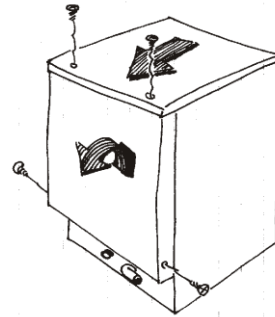

- Remove top screws first
- Slide panel towards the back and lift
- Remove the side screws on both side of the rear panel.
- Slide the rear panel up and away from the unit.

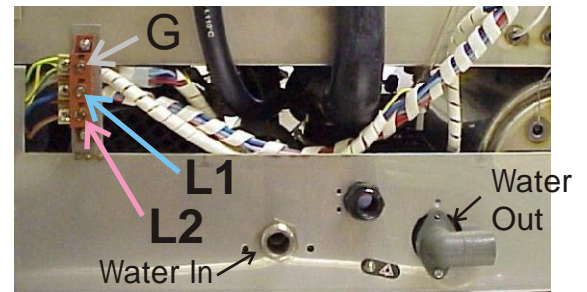

## Connecting your new F-20

This dishwasher must be installed on a level, rigid, nonflammable surface. Ensure that the machine is level by installing the feet (shipped in the wash tank of the machine) and adjusting the leveling. Be sure to provide adequate space for water, drain and electrical connections.

### \*\*WATER SUPPLY:\*\*

A 3/4" NPT fitting is required with 30 psi. dynamic pressure. A water pressure regulator\* may be required. The water pressure cannot be less than 30 psi or exceed 30 psi. If the water pressure exceeds the prescribed amount, you will get inconsistent washing temperature, premature parts failure and thus may void the warranty.

Incoming water temperature must be 140° F (60° C). An easily accessible shut-off valve is recommended, making installation, service and maintenance easier. A flexible drain hose is provided to make installation, servicing and maintenance easier.

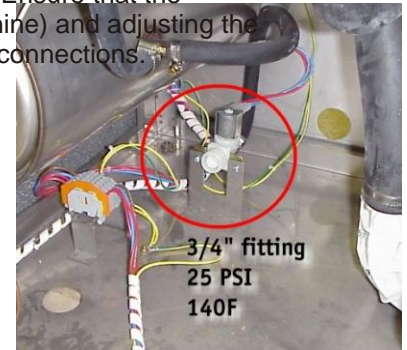

Make sure that the water is free from calcium and hard water deposits. For these situations, an on-line water cartridge system is highly recommended. Build-up of calcium and lime deposits in the washer may occur and servicing will be required on a more frequent basis which will not be covered by the warranty.

### \*\*DRAIN:\*\*

This dishwasher has a gravity drain. Maximum height of the floor drain should not exceed 20" (50cm). A 1.5" ID flexible drain hose is recommended to facilitate maintenance and servicing of the machine.

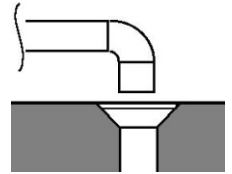

### ELECTRICAL:

A 208-240 volt, 60 Hz, Single Phase circuit is required for this unit. Check the rating plate on the machine for amp draw. In spite of the fact that the rating plate shows 208 volts, the unit is designed function properly on 208 volts to 240 volts.

The top & back panels must be removed for the electrical hook-up. The top panel is secured by Phillips head screws. Once the screws removed, the panel should be slid to the back and lifted. The back panel is also held by Phillips head screws. Remove them, pull the bottom away from the machine and lift the panel.

The terminal block is located at the top of the machine and can be accessed by removing the top and back panel. Pass the cable through the cable strain relief at the back and connect the wires to the terminals L1 (brown wire), L2 (blue wire) & Ground (yellow & green wire). There should be sufficient cable length to permit the machine to be pulled out for service.

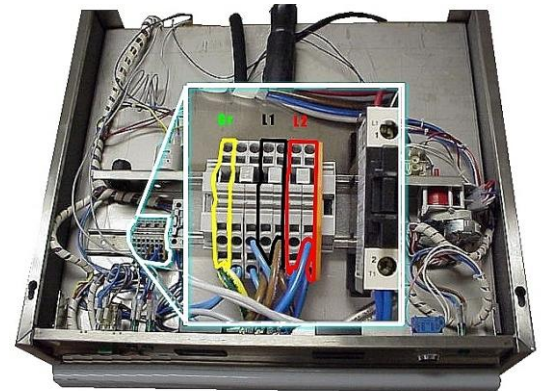

**DO NOT** manually fill wash tank with water. The dishwasher will fill automatically when the power is turned ON.

### IMPORTANT NOTE

Reasonable access to and around the machine for service must be provided. Disconnecting of hard plumbing or removal of counter tops or cabinets, etc., for servicing is not covered by warranty.

All panels must be replaced on the unit when the installation is completed.

\* - not supplied

**\*\* SEE PAGE 6 FOR FURTHER IMPORTANT DETAILS\*\***

## Connecting your new F-22

This dishwasher must be installed on a level, rigid, nonflammable surface. Ensure that the machine is level by installing the feet (shipped in the wash tank of the machine) and adjusting the leveling. Be sure to provide adequate space for water, drain and electrical connections.

### \*\*WATER SUPPLY:\*\*

A 3/4" NPT fitting is required with 30 psi. dynamic pressure. A water pressure regulator\* may be required. The water flow pressure cannot be less than 30 psi or exceed 30 psi. If the water pressure exceeds the prescribed amount, you will get inconsistent washing temperature, premature parts failure and thus may void the warranty.

Incoming water temperature must be 140° F (60° C). An easily accessible shut-off valve is recommended, making installation, service and maintenance easier.

A flexible drain hose is provided to make installation, servicing and maintenance easier.

Make sure that the water is free from calcium and hard water deposits. For these situations, an inline water cartridge system is highly recommended. Build-up of calcium and lime deposits in the washer may occur and servicing will be required on a more frequent basis which will not be covered by the warranty.

### \*\*DRAIN:\*\*

This dishwasher has a gravity drain. Maximum height of the drain should not exceed 20" (50cm). A 1.5" ID flexible drain hose\* is recommended to facilitate maintenance and servicing of the machine.

### ELECTRICAL:

A 208-240 volt, 60 Hz, Single Phase or Three Phase circuit is required for this unit. Check the rating plate on the machine for amp draw and phase. In spite of the fact that the rating plate shows 208 volts, the unit is designed function properly from 208 volts to 240 volts.

The terminal block is located in the control box on the side of the unit. The faceplate of the control panel pulls out, exposing the terminal block, after the screws are removed. Pass the cable through the cable strain relief at the back and connect the wires to the terminals L1 (brown wire), L2 (blue wire), L3 (black wire) & Ground (yellow & green wire). There should be sufficient cable length to permit the machine to be pulled out for service.

**DO NOT** manually fill wash tank with water. The dishwasher will fill automatically when the power is turned ON.

### IMPORTANT NOTE

Reasonable access to and around the machine for service must be provided. Disconnecting of hard plumbing or removal of counter tops or cabinets, etc., for servicing is not covered by warranty.

All panels must be on the unit when the installation is finished.

\* - not supplied

**\*\* SEE PAGE 6 FOR FURTHER IMPORTANT DETAILS\***



## F-22 Dish Table configuration

The F-22 is design to received standard size dish-tabling.



Below you can see the different configurations that can be done with the F-22.

If the soiled (sink) section is on the right side (control panel side), the control panel can be adjusted down to allocate room for the sink.

If you need to do a corner installation, change the bracket that guides the trays from the front to the left side.

F22 Table joining the dish machine



F22 Bracket to installed from the front to the side for corner application



F22 Straight-Through Application



dish tabling measurements

F22

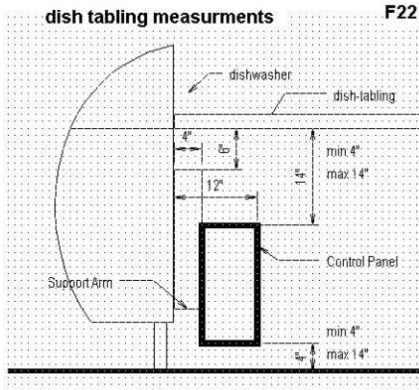

F22 Scrap side (sink) on the control panel side.



## Connecting your new 727

This dishwasher must be installed on a level, rigid, nonflammable surface. Ensure that the machine is level by installing the feet (shipped in the wash tank of the machine) and adjusting the leveling. Be sure to provide adequate space for water, drain and electrical connections.

### \*\*WATER SUPPLY\*\*

A 3/4" NPT fitting is required with 30 psi. dynamic pressure. A water pressure regulator\* may be required. The water flow pressure cannot be less than 30 psi or exceed 30 psi. If the water pressure exceeds the prescribed amount, you will get inconsistent washing temperature, premature failure and thus may void the warranty. Incoming water temperature must be 140° F (60° C). An easily accessible shut-off valve is recommended, making installation, service and maintenance easier. This type hose is standard for most warewashing machines. Fittings should be available from your local hardware or plumbing supply house.

Flexible hoses must be used to make installation, servicing and maintenance easier.

Make sure that the water is free from calcium and hard water deposits. For these situations, an on-line water cartridge system is highly recommended. Build-up of calcium and lime deposits in the washer may occur and servicing will be required on a more frequent basis which will not be covered by the warranty.

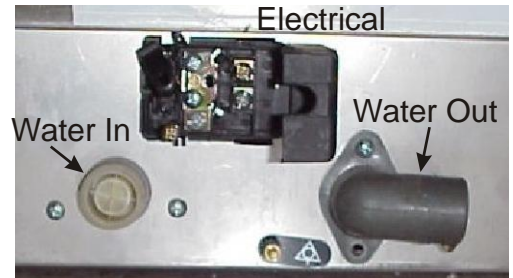

### \*\*DRAIN\*\*

This dishwasher is equipped with an automatic drain pump that will pump the drain water to a maximum height of 36" (0.9 meter). A 1" ID flexible drain hose is recommended to facilitate maintenance and servicing of the machine. It is important not to reduce the size of this hose. There should be sufficient hose length to permit the machine to be pulled out for service.



### ELECTRICAL

A 208-240 volt, 60 Hz, Single Phase circuit is required for this unit. Check the rating plate on the machine for amp draw. Despite of the fact that the rating plate shows 208 volts, the unit is designed function properly on 208 volts to 240 volts.

The terminal block is located at the back of the unit.

Open the cover and connect the wires to the terminals

L1 , L2 & Ground. There should be sufficient cable length to permit the machine to be pulled out for service. **DO NOT TURN ON THE POWER TO THE MACHINE UNTIL THE WATER SUPPLY & DRAIN LINES HAVE BEEN CONNECTED.**

### IMPORTANT NOTE

Reasonable access to and around the machine for service must be provided. Disconnecting of hard plumbing or removal of counter tops or cabinets, etc., for servicing is not covered by warranty.

\* - not supplied

All panels must be on the unit when the installation is finished.

**\*\* SEE PAGE 6 FOR FURTHER IMPORTANT DETAILS\*\***

## Connecting your new 737

This dishwasher must be installed on a level, rigid, nonflammable surface. Ensure that the machine is level by installing the feet (shipped in the wash tank of the machine) and adjusting the leveling. Be sure to provide adequate space for water, drain and electrical connections.

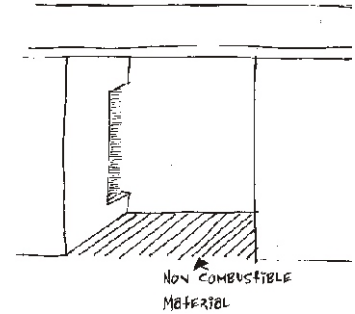

### \*\*WATER SUPPLY\*\*

A 3/4" NPT fitting is required with 30 psi. dynamic pressure. A water pressure regulator\* may be required. The water flow pressure cannot be less

than 30 psi or exceed 30 psi. If the water pressure exceeds the prescribed amount, you will get inconsistent washing temperature, premature failure and thus may void the warranty.

Incoming water temperature must be 140° F (60° C). An easily accessible shut-off valve is recommended, making installation, service and maintenance easier. This type hose is standard for most warewashing machines. Fittings should be available from your local hardware or plumbing supply house.

Flexible hoses must be used to make installation, servicing and maintenance easier.

Ensure that the water is free from calcium and hard water deposits. For these situations, an inline water cartridge system is highly recommended. Build-up of calcium and lime deposits in the washer may occur and servicing will be required on a more frequent basis which will not be covered by the warranty.

### \*\*DRAIN\*\*

This dishwasher is equipped with an automatic drain pump that will pump the drain water to a maximum height of 36" (0.9 meter). A 1" ID flexible drain hose is recommended to facilitate maintenance and servicing of the machine. It is important not to reduce the size of this hose. A 1" check-valve\* may be required.

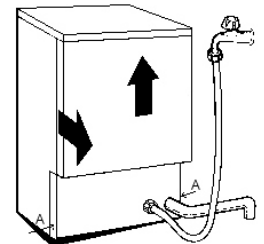
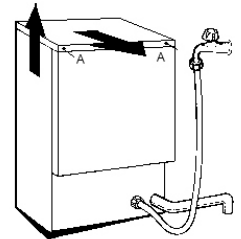

### ELECTRICAL

A 208-240 volt, 60 Hz, Single Phase circuit is required for this unit. Check the rating plate on the machine for amp draw. In spite of the fact that the rating plate shows 208 volts, the unit is designed function properly on 208 volts to 240 volts. There should be sufficient cable length to permit the machine to be pulled out for service.

The top & back panels must be removed for the electrical hook -up. The top panel is secured by Phillips head screws. Once the screws removed, the panel should be slid to the back and lifted. The back panel is held by 6 screws. Remove them, pull the top away from the machine and lift the panel.

The terminal block is located at the back of the machine.

Pass the cable through the cable strain relief at the back and connect the wires to the terminals L1 (brown wire), L2 (blue wire) & Ground (yellow & green wire). There should be sufficient cable length to permit the machine to be pulled out for service. **DO NOT TURN ON THE POWER TO THE MACHINE UNTIL THE WATER SUPPLY & DRAIN LINES HAVE BEEN CONNECTED.**

#### IMPORTANT NOTE

Reasonable access to and around the machine for service must be provided. Disconnecting of hard plumbing or removal of counter tops or cabinets, etc., for servicing is not covered by warranty.

\* - not supplied

All panels must be on the unit when the installation is finished.

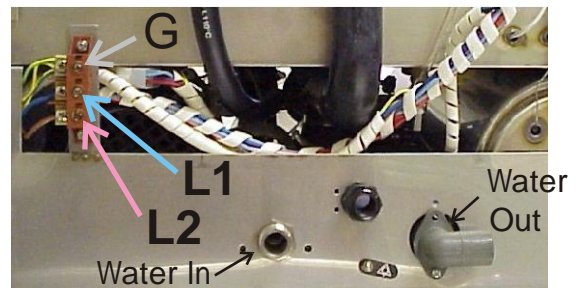

**\*\* SEE PAGE 6 FOR FURTHER IMPORTANT DETAILS\*\***

## Connecting your new 747

This dishwasher must be installed on a level, rigid, nonflammable surface. Ensure that the machine is level by installing the feet (shipped in the wash tank of the machine) and adjusting the leveling. Be sure to provide adequate space for water, drain and electrical connections.

### \*\*WATER SUPPLY\*\*:

A 3/4" NPT fitting is required with 30 psi. dynamic pressure. A water pressure regulator\* may be required. The water flow pressure cannot be less than 30 psi or exceed 30 psi. If the water pressure exceeds the prescribed amount, you will get inconsistent washing temperature, premature parts failure and thus may void the warranty.



Incoming water temperature must be 140° F (60° C). An easily accessible shut-off valve is recommended, making installation, service and maintenance easier. This type hose is standard for most warewashing machines. Fittings should be available from your local hardware or plumbing supply house.

Flexible hoses must be used to make installation, servicing and maintenance easier.

Make sure that the water is free from calcium and hard water deposits. For these situations, an inline water cartridge system is highly recommended. Build-up of calcium and lime deposits in the washer may occur and servicing will be required on a more frequent basis which will not be covered by the warranty.

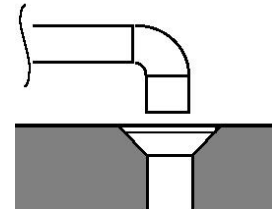

### \*\*DRAIN\*\*:

This dishwasher has a gravity drain. Maximum height of the drain should not exceed 20" (50cm). A 1.5" ID flexible drain hose is recommended to facilitate maintenance and servicing of the machine.

### ELECTRICAL:

A 208-240 volt, 60 Hz, Single Phase or Three Phase circuit is required for this unit. Check the rating plate on the machine for amp draw. Pump rotation must be verified on 3 phase units at time of install. In spite of the fact that the rating plate shows 208 volts, the unit is designed function properly from 208 volts to 240 volts.

The bottom cover (under the controls) is snapped in to position and should be removed. The terminal block is located in the base of the unit, on the left side.

Pass the cable through the cable strain relief at the back and connect the wires to the terminals L1 (brown wire), L2 (blue wire), L3 (black wire) & Ground (yellow & green wire). There should be sufficient cable length to permit the machine to be pulled out for service.

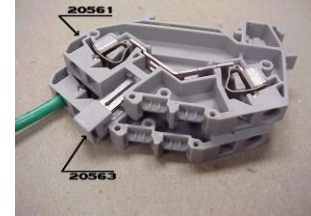
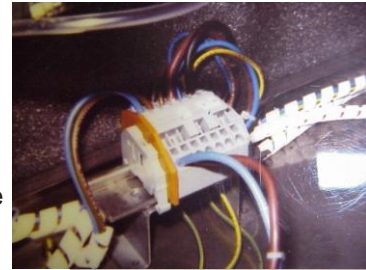

**DO NOT** manually fill wash tank with water. The dishwasher will fill automatically when the power is turned ON.

### IMPORTANT NOTE

Reasonable access to and around the machine for service must be provided. Disconnecting of hard plumbing or removal of counter tops or cabinets, etc., for servicing is not covered by warranty. Verify rotation of the pumps for three phase unit.

All panels must be replaced on the unit when the installation is completed.

\* - not supplied

**\*\* SEE PAGE 6 FOR FURTHER IMPORTANT DETAILS\*\***





## Connecting your new 767

This dishwasher must be installed on a level, rigid, nonflammable surface. Ensure that the machine is level by installing the feet (shipped in the wash tank of the machine) and adjusting the leveling. Be sure to provide adequate space for water, drain and electrical connections.

### **\*\*WATER SUPPLY:\*\***

A 3/4" NPT fitting is required with 30 psi. dynamic pressure. A water pressure regulator\* may be required. The water flow pressure cannot be less than 30 psi or exceed 30 psi. If the water pressure exceeds the prescribed amount, you will get inconsistent washing temperature, premature parts failure and thus may void the warranty.

Incoming water temperature must be 140° F (60° C).

A flexible drain hose is provided to make installation, servicing and maintenance easier.

Make sure that the water is free from calcium and hard water deposits. For these situations, an on-line water cartridge system is highly recommended. Build-up of calcium and lime deposits in the washer may occur and servicing will be required on a more frequent basis which will not be covered by the warranty.

### **\*\*DRAIN\*\*:**

This dishwasher has a gravity drain. Maximum height of the drain should not exceed 20" (50cm). A 1.5" ID flexible drain hose is provided to facilitate maintenance and servicing of the machine.

### **ELECTRICAL:**

A 208-240 volt, 60 Hz, Single Phase or Three Phase circuit is required for this unit. Check the rating plate on the machine for amp draw and phase. Pump rotation must be verified on 3 phase units at time of install. In spite of the fact that the rating plate shows 208 volts, the unit is designed function properly from 208 volts to 240 volts.

The terminal block is located under the control panel, inside the machine. Pass the cable through the cable strain relief at the back and connect the wires to the terminals L1 (brown wire), L2 (blue wire), L3 (black wire) & Ground (yellow & green wire). There should be sufficient cable length to permit the machine to be pulled out for service.

**DO NOT** manually fill wash tank with water. The dishwasher will fill automatically when the power is turned ON.

### **IMPORTANT NOTE**

Reasonable access to and around the machine for service must be provided.

Disconnecting of hard plumbing or removal of counter tops or cabinets, etc., for servicing is not covered by warranty.

Verification of the pump rotation is very important!

All panels must be on the unit when the installation is finished.

\* - not supplied

**\*\* SEE PAGE 6 FOR FURTHER IMPORTANT DETAILS\*\***

## CHEMICAL PUMPS

Models 727, 737, 747, 767, F-14, F-16DP, F-18, F-18DP, F-20 & F-22 are supplied with factory installed liquid detergent and rinse additive pumps to automatically dispense during each wash & rinse cycle. Before accessing the bottom section of the dishwasher, make sure that the power is turned off at the source (breaker panel).

The bottom panel can only be removed with a flat tool like a screw-driver. Insert the screw-driver in the gap between the front panel and the side panel. Pry open towards you. Do this on both sides.

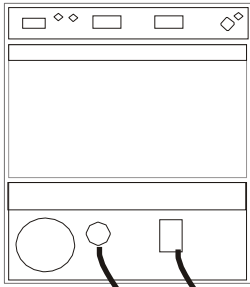

The red & blue hoses connected to the pumps must be routed out of the bottom of the dishwasher. The red tube is for detergent and the blue tube is for rinse additive. The containers can be either to the right or left of the dishwasher. Perforating the stainless panel is not recommended.

The two chemical pumps are factory adjusted to accommodate most installations. There is a mark on the pump indicating this setting. It is recommended that only qualified personnel alter these settings. **UNDER NO CIRCUMSTANCES** should the detergent pump be turned off.

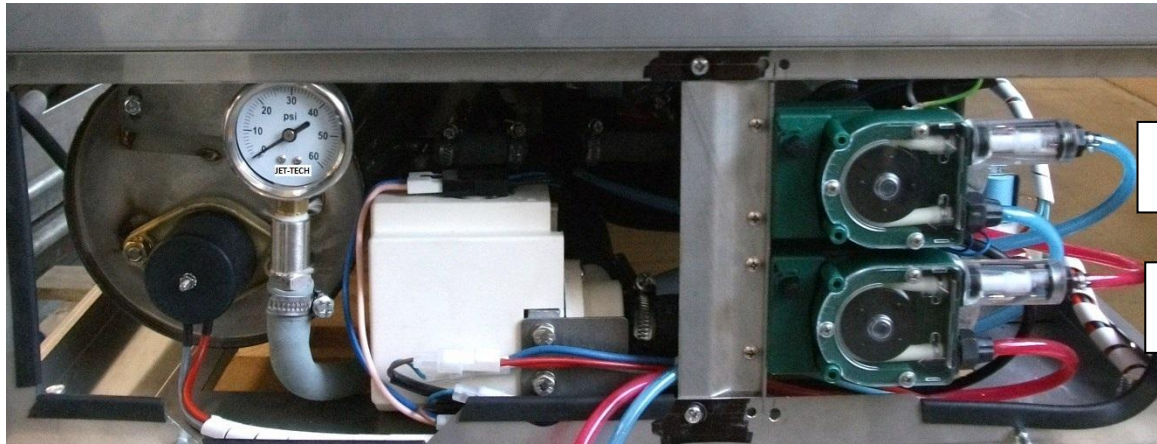

**F-18DP**

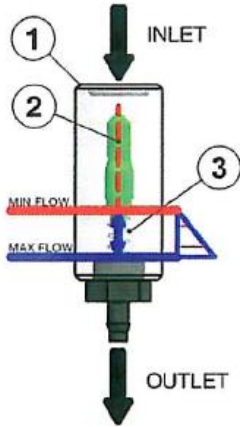

## VISUAL CHEMICAL DELIVERY VERIFICATION

The peristaltic chemical pumps are located in the base of the dishwasher. They feature a transparent cylinder (1) to visually see if fluid is passing through the pumps. The pumps are automatically energized during the “initial fill” (when turning on the dishwasher) and “rinse cycle” (after the wash cycle). During this time, the flow indicator (2) will move between the “Min Flow” position and the “Max Flow” position (3) in the cylinder. It is normal for the pumps to cycle on and off.

If the flow indicator (2) does not move during the fill or rinse, no fluid is circulating through the pump. It is recommended not to use the dishwasher until this condition is resolved.



F-18DP

## TROUBLESHOOTING

1. Ensure that there is sufficient chemical in the container and that the tube is not kinked. The filter on the end of the tube must reach to the bottom of the container. If the filter or tube is blocked, remove and soak in warm water to dislodge the obstruction.
2. There may be air in the pump. To “Prime” the pumps (remove the air), turn off and drain the dishwasher. Replace the stand pipe, close the door and turn on the dishwasher. The pumps will be activated as the machine fills. The Flow Indicators (2) should start to move by the time the machine has filled. If not, repeat the drain and fill.
3. The Squeeze Tube (flexible tube inside the pump) is worn or perforated. This part is a normal wear and tear item that must be replaced periodically (when pump performance diminishes). Call for Service.
4. The pump does not operate - the roller in the middle of the pump does not turn during the fill or rinse. Call for Service.

For any other request on set-up and installation, please contact us toll free at 1 888 275 4538 extension 611 or (514) 737-9701 (International)

**IMPORTANT:** Remember to always use caution and protective gear whenever you are manipulating chemicals. They can burn the skin. Follow the manufacturer’s instructions carefully.



## CONTROL PANELS

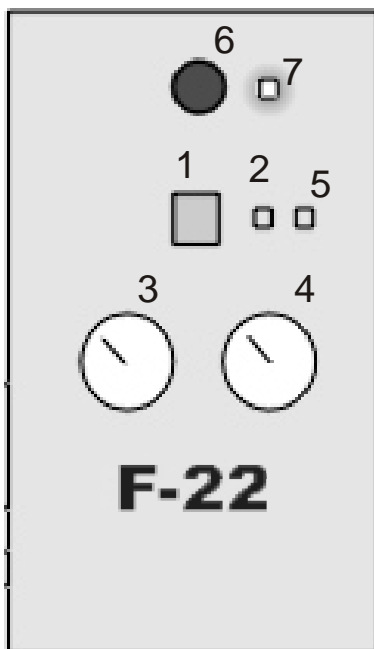
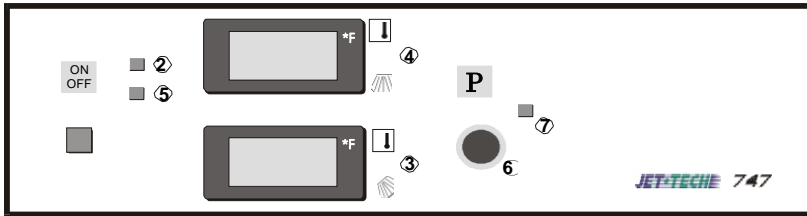

- 1 Green Power Button Switch
- 2 Power ON Indicator Light
- 3 Rinse Temperature Gauge
- 4 Wash Temperature Gauge
- 5 "READY" Indicator Light
- 6 Cycle Start Button
- 7 Cycle Indicator Light
- 8 White Drain Pump Button

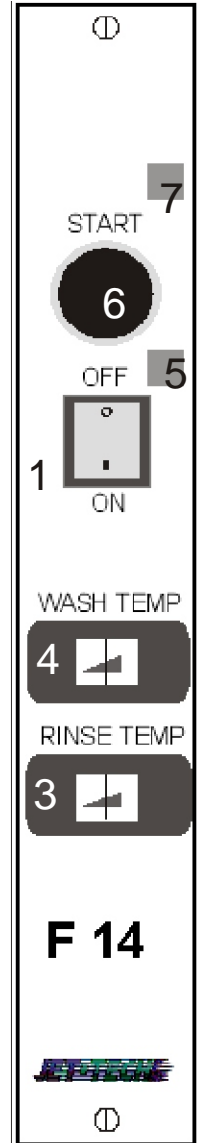

**F 14**

## BASIC STEPS TO START

Begin with an empty dishwasher. The wash tank should be empty.



Make sure the filter screens and the overflow pipe are in place.



Close the door.



Push the square green button. The dishwasher will take about two minutes to fill and 20 minutes to heat the water. The booster (rinse) will heat up first and then the wash tank will heat up.



When the dishwasher is ready, the ready light will come on. This indicates that the dishwasher has reached optimum temperature.



You can now start washing.



Fill the basket. Only one basket can be used at a time.



Slide it in to the dishwasher.



Close the door and press the round black button. The dishwasher will start washing for a few minutes. When the wash pump stops, the rinse is about to start. Verify that the Rinse Pressure Gauge (P.6) is showing 20-30 PSI and that the Chemical Flow Indicators (P.19) are moving. The rinse continues for approximately 20 seconds.



When the cycle light (near the start button) goes off, open the door and remove the tray to let air dry.



If you are ready for another wash, slide a basket in the dishwasher, close the door & press the Cycle Start Button. If not, just close the door to retain the heat in the dishwasher and conserve energy.

You should drain the dishwasher at least once a day or when the water is soiled. The dishwasher should be turned off, drained, cleaned and left empty at night.

To drain the dishwasher, follow these simple steps;



Turn OFF the power.



Pull out the overflow tube (CAUTION: water may be hot)



Press the white drain button (if so equipped) until all the water is gone. Be careful not to let any debris go down the drain as it may block the pump.

## OPERATION

Before operating the machine, ensure that the electrical power, water supply and drain connections have been made as per the installation instructions.

Ensure that the overflow pipe is correctly set in its place (inside the wash tank). The overflow pipe should never be forced into its position. For the first use of the day, the wash tank should not have any water.

Familiarize yourself with the gauges, buttons and indicator lights on the control panel.

Check chemical levels. The containers should have sufficient quantities of Detergent (for wash) and Rinse Additive (drying agent).



Press the Square Green Power Button (1). The Power Indicator Light will illuminate (as well as the Digital Temperature Gauges, if so equipped). If the wash tank is empty, the machine will start to fill. Always keep the door closed during this time. When the machine has filled to its required water level, the elements will then raise the rinse and wash water temperatures automatically.

It will take approximately 15-20 minutes in order to obtain the optimum temperatures (185°F in the booster and 160°F in the wash tank). The Ready Indicator Light (5) will illuminate to indicate that the machine is ready for its first load.

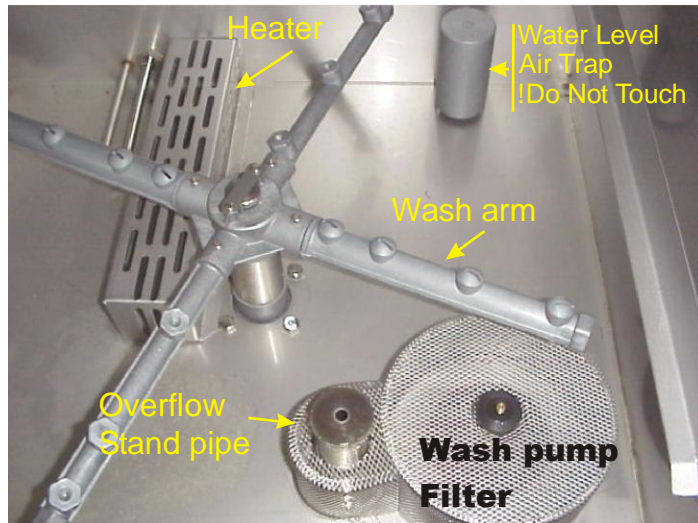

Fill the basket with dishware and trays then push the basket into the machine.

It is more economical to wash when the basket is fully loaded. It is also important not to overload the basket. Water should always be able to spray freely around the dishware and trays.

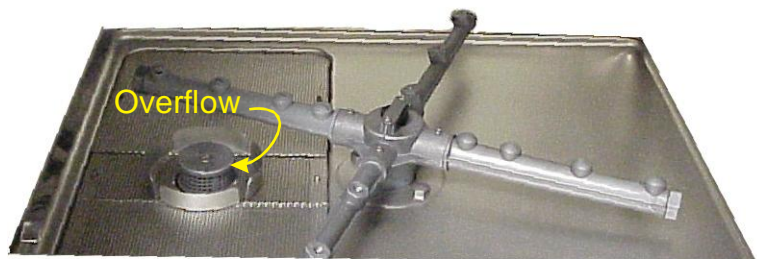

Press the round black Cycle Start Button (6) to start the wash cycle.

On the model 767, set the selector to 2, 4 or 6 minute wash.

Closing the hood on Models F-22, 747 & 767 will automatically start the cycle. The Cycle Indicator Light (7) will illuminate. The cycle starts and consists of a wash (up to 6 minutes), a brief pause and then a rinse (from 18 to 25 seconds). Another basket can be filled while the first one is being washed. The Cycle Indicator Light (7) will extinguish to signal the end of the cycle. It is important to remove the basket from the machine while they are hot to let the dishes air dry. They will not dry if left in the machine.

## **IMPORTANT NOTES:**

-The models F-22, 747 and 767 differ from the under-counter units in the way to initiate the wash cycle. Once the unit has filled up with water and the temperatures have reached their maximums, slide the basket in and close the door. Closing the door will start the wash cycle. At the end of the cycle, after the cycle light has switched off, open the door and remove the basket. The cycle light will come on at that point for a few seconds to reset the timer for the next wash.

- JET-TECH high temperature warewashers do not dump water and fill after every cycle. The wash water is refreshed during every cycle by the hot rinse water. Only excess water is expelled from the machine via the overflow pipe. If the wash water becomes soiled, it is recommended turn off and drain the dishwasher, clean all debris from the filters and wash tank and turn on the dishwasher to fill with fresh water

- Some models are equipped with an automatic drain pump (White button on the front control panel) that will evacuate excess water. Please see the section on: DRAIN PUMP OPERATION.

- During the rinse cycle, verify that Rinse Pressure is 30 PSI and that the Chemical Flow Indicators are moving.

- IMPORTANT: If the dishwasher will not be used for two (2) or more hours, it should be drained and turned off. The dishwasher should never be left in the "ON" position and unattended.

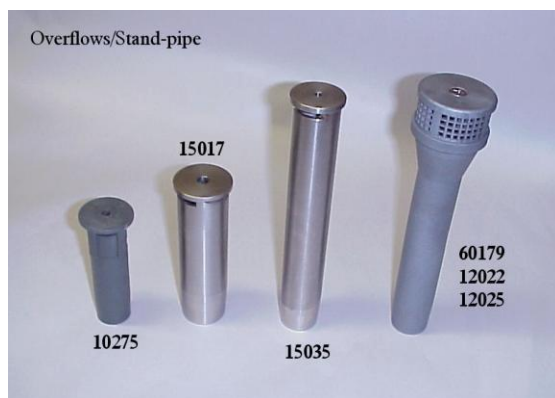

# Jet-Tech F-18DP

## BASIC STEPS TO OPERATE



Make sure dishwasher is empty (no water) and the filters & wash tank are clean of debris.



Close the door and press the power button. Wait 20 minutes for the water to attain optimum washing temperatures.



Pre-rinse dishes and/or glasses and cups.



Load rack in the dishwasher and close the door. Only one rack at a time.



Press the Start button.  
 Wash cycle is 3 minutes.



Wait for the green light to turn off before taking the tray out.  
 Take tray out to let dishes air dry.



# F-22

## BASIC STEPS TO OPERATE



At the start of each day, ensure dishwasher is empty (no water) and that the wash tank is clean (no debris)

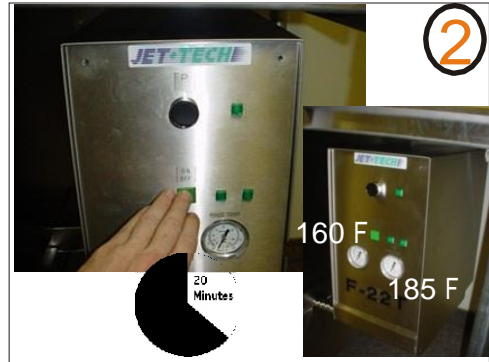

Close the door, press the Power Button to ON. Wait for the water to obtain optimum washing temperature.



Pre-rinse dishes, glasses and cups.



Load rack in the dishwasher and close the door. Only one rack at a time.



Close the door to start the wash cycle.

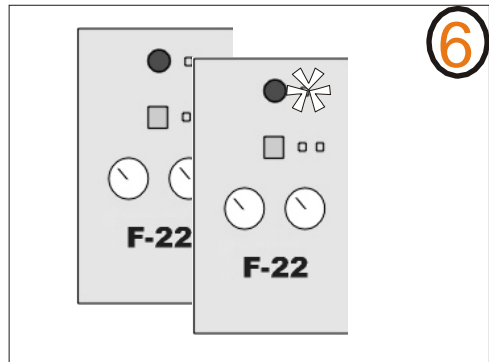

Wait for the green light to turn OFF before removing the rack. Repeat from step 3 for more trays.

## DRAIN PUMP OPERATION

Models 727, 737, F-16DP and F-18DP are factory built with drain pumps. A square white button on the control panel beside the green power button also evidences this feature. All other models have a gravity drain.

Drain pump equipped models will pump the waste water to a maximum height of 36" (0.9 meter). A 1" ID flexible hose of sufficient length is provided to facilitate maintenance and servicing of the machine. It is important not to reduce the size of this hose. A 1" check valve\* may be required. There should be sufficient hose length to permit the machine to be pulled out for service. Drainage time should not exceed 1 minute.

The drain pump activates automatically during a rinse cycle and functions when the water fill valve is open: during the fill and rinse cycles. This allows the removal of excess water entering the unit.

To manually drain the wash tank, you must:

1. -Turn off the machine (square green button on control panel).
2. -Open the door, remove the basket, and remove the overflow pipe (also known as stand pipe).
3. -Press and hold the white button on the control panel, which will activate the drain pump.  
Release the button when the water has been discharged.

The most common causes of drain pump failure are:

- Debris was flushed down the drain and blocked the impeller in the pump. Removing the impeller cover and clearing the obstruction generally restores normal pump function.
- The drain hose, at the back of the unit, is restricted.

**IMPORTANT!** Pump failure caused by debris blockage is NOT covered by the warranty.

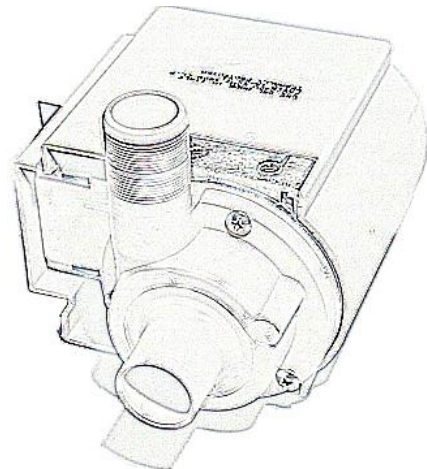
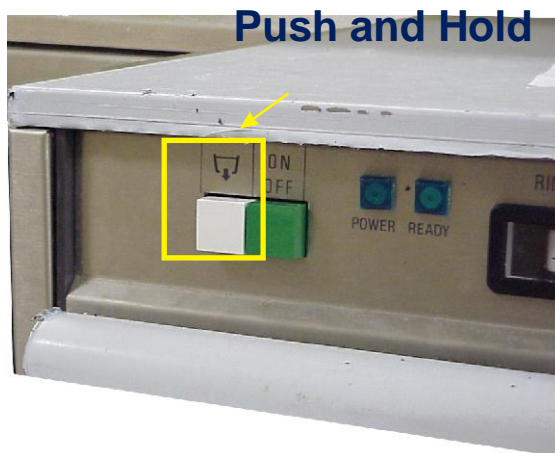

\* - not supplied

# F 18

## DAILY CLEANING PROCEDURES TO FOLLOW

This should be done at least once a day.



Push Power switch to OFF

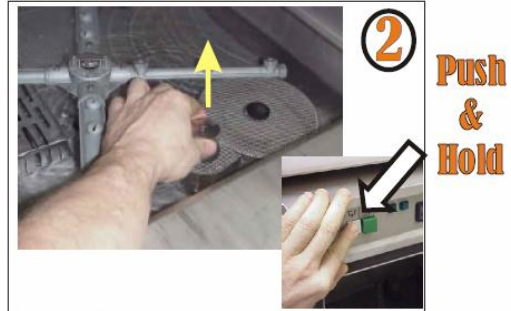

1] Open the door.  
 2] Remove the Over-flow tube,  
 3] Drain unit. Push and hold white button.

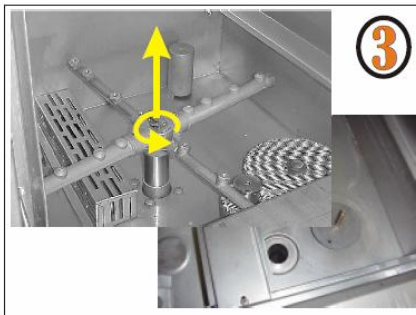

Let the water drain in the wash tank.  
 Remove the spin-arm by unscrew the thumb-screw in the centre.  
 Remove all the screens.  
 Don't forget the top spin-arm.



Clean the screens and wash tank of debris.  
 Rinse wash tank.  
 Be careful not to push food debris down the drain.



Put all parts back in the wash tank.  
 Leave the dishwasher empty overnight



OR refill for more usage by closing the door and pressing the green button.

## PROBLEM ANALYSIS INDEX

1. Constantly fills
2. Dishwasher makes a high pitch noise when washing
3. Dishwasher overflow
4. Does not operate/start
5. Does not wash properly
6. Filling is too long. Exceeds 3 minutes.
7. Filling is too short (under 1 minute)
8. Machine takes too long to empty. Time exceed 2 minutes.
9. Pilot lamps do not illuminate
10. Spots on glasses
11. The wash pump does not operate consistently during a wash cycle
12. Wash cycle is too short

## PROBLEM >CHECK >>ACTION

### 1. Constantly fills

>Dishwasher has inactive/not been drained in a long time (more than three hours).

>>Switch dishwasher OFF. Pull over-flow and drain unit completely. Once drained, clean wash tank and filters. Put all parts back in. Close door, switch it ON, and let fill.

>Is overflow tube(stand-pipe) properly positioned in wash tank?  
>>Check for cracks or burrs at bottom of overflow tube.

>The air pressure switch may be faulty.  
>>Replace switch.

>The water level system may have an air leak.

>>verify the water level system from the pressure switch to the tube down to the air trap. Replace the defective parts as required.

>The air trap may have dirt in it.

>>Clean the air trap.

### 2. Dishwasher makes a high pitch noise when washing

>The wash tank may have too much detergent.

>>Too much soap may cause the pump to make a high pitch noise. Reduce the detergent amount; and ensure it is of the non-foaming type used. The mechanical seals may be worn. Replace as required.

### 3. Dishwasher overflow

>Drain outlet hose may be blocked.

>>Un-clog or reposition hose or replace the drain hose.

>Drain pump may be blocked or defective not allowing proper drainage of machine.

>>Un-clog or replace drain pump, as required.

>Incoming water pressure may be incorrect.

>> If the water pressure is too high (above 30 psi), you must install a pressure regulator.

>Regular dishwashing soap may have been used or has contaminated the dishwasher accidentally, causing an excessive amount of sudsing.

>>Drain the tank, remove as much

suds as possible. Leave overflow out, close the door and put power on. Let unit run for 2 to 4 minutes. Turn off unit, put overflow back in, close the door and refill unit. Try washing. If reoccurs try from the beginning again.

>The solenoid valve may have dirt in it or may be defective.  
>>Clean the filter or replace as required.

#### 4. Does not operate or start

>The door micro switch may be defective.  
>>Adjust switch. Some of the parts may have to be replaced.

>The momentary relay may be defective or disconnected.  
>>All wires must well in place. If so replace it.

>The power switch may be unplugged or defective.  
>>Verify connections and replace as required.

>The pressure switch may be faulty.  
>>Adjust switch. Replace as required.

>The solenoid valve may have dirt in it or may be defective.  
>>Clean filter or replace as required.

>The timer may be defective.  
>>Replace.

>The washing cycle button may be defective.  
>>Replace.

>The wiring may have a break or short to ground.

>>Verify all connections.

>Verify that power is going to the machine.  
>>Verify the breaker or fuses. Verify electrical connections to the machine.

#### 5. Does not wash properly

>Are the scrap screens clean?  
>>Clean the scrap screens & filters. Don't forget the wash pump screen.

>Are the wash/rinse arm jets clogged?  
>>Clean the jets/nozzles. Be careful not to lose the o-rings.

>Detergent system may be defective.  
>>Peristaltic hose(s) may have to be replaced. The detergent filter in the container may be clogged or worn. Replace. Check the detergent line for deposits. Clean the line if necessary.

>Dishes appear dirty after the cycle is completed.  
>>Pre-rinse the dishes properly before they are placed into the dish racks.

>Drain outlet hose may be blocked. Drain pump may be blocked or defective, and is not allowing proper drainage of machine.  
>>Un-clog, reposition hose or change drain hose. Un-clog or replace drain pump, as required.

>Incoming water pressure may be either too low or too high will result in poor rinsing.  
>>If the pressure is too low (under 20 psi), check that the valve is fully

opened. If it is, the customer may need to install a pressure-booster pump to increase the water pressure. If the water pressure is too high (above 30psi), you must install a pressure regulator.

>Is the wash water clean?  
>>Drain the tank, rinse and refill.

>Is the water level in the wash tank correct?  
>>Water level should be just under the opening of the overflow pipe. Too little water will cause the wash pump to draw air. Too much water will keep the arm from spinning properly and may cause water to come out the door. Both cases reduce the performance of the dishwasher.

>Small specs remain on glasses after rinsing.  
>Have the incoming water analysed. May need a filtering system.

>The air pressure switch may be faulty.  
>>Replace Pressure switch

>The air trap may have dirt in it.  
>>Clean the air trap.

>The detergent used is of poor quality.  
>>Replace with a better quality commercial brand or increase dosage.

>The solenoid valve may have dirt in it or may be defective.  
>>Clean filter or replace as required.

>Wash pump may be clogged or defective.  
>>Open face plate of wash pump for inspection. Clean wash pump or replace it if necessary.

## **6. Filling is too long. Exceeds 3 minutes.**

>Incoming water pressure may be incorrect.  
>>If the pressure is too low (under 20 psi), check that the faucet is fully opened. If it is, the customer may need to install a pressure-booster pump to increase the water pressure.

>The stand-pipe may be set incorrectly.  
>>Remove the stand-pipe and check the seat for dirt.

>The air pressure switch may be faulty.  
>>Adjust or replace as required.

>The air trap may have dirt in it.  
>>Clean the air trap.

>The solenoid valve may have dirt in it or may be defective.  
>>Clean filter or replace as required.

## **7. Filling is too short (under 1 minute)**

>The air pressure switch may be faulty.  
>>Adjust or replace as required.

>Incoming water pressure is probably too high (above 30PSI flow).  
>>Install a water Pressure Reducing Valve.

>The air trap may have dirt in it.  
>>Clean the air trap.

## 8. Machine takes too long to drain. Time exceed 2 minutes. Should be less than 1 minute.

>Drain outlet hose may be blocked or kinked.

Drain pump may be blocked or defective not allowing proper drainage of machine.

>>Un-clog or reposition hose or replace the drain hose. Un-clog or replace drain pump, as required.

>The overflow pipe may be clogged.

>>Clean out any residue.

## 9. Pilot lamps do not illuminate

>Pilot lamps may be faulty.

>>Check connections. Replace as required.

>The power switch may be unplugged or defective.

>>Verify and replace as required.

>>Verify the breaker.

>>Verify electrical connections behind the machine

## 10. Spots on glasses

>Rinse aid pump may need to be primed or adjusted.

>>Prime or adjust. Replace as required.

>The rinse agent may be of an inferior quality.

>>Replace with a quality commercial brand.

## 11. The wash pump does not operate consistently during a

## wash cycle

>Machine may not be leveled.

>>Level the dishwasher.

>The air pressure switch may be faulty.

>>Adjust or replace as required.

>The air trap may have dirt in it.

>>Clean the air trap.

>Water level in wash tank is too low.

>>Adjust pressure switch or replace as required. Water level should be level with the stand-pipe opening.

## 12. Wash cycle is too short

>The timer may be defective.

>>Replace.

## IMPORTANT NOTES

Locate and clearly identify the water shut-off valve that supplies the dishwasher and the fuse box or breaker switches.

Only qualified and/or licensed technician can repair this piece of equipment. Removing panels exposes wires and live current. The breaker should be switched off or fuses removed before servicing or removing the panels. The water supply must also be turned off.

Don't expose yourself injury.

Call Jet-Tech for service or support.





BLANK PAGE





*HELP!!*

Do you have any questions?  
Do you need service?



Phone:  
888-275-4538 toll free  
(514) 737-9701  
Fax:  
877-453 8832 toll free  
(514) 737-2792  
Email: [service@jet-tech.com](mailto:service@jet-tech.com)

MODEL: \_\_\_\_\_  
SERIAL: \_\_\_\_\_  
DATE INSTALLED: \_\_\_\_\_

SERVICE:  
\_\_\_\_\_  
\_\_\_\_\_

# OWNER'S MANUAL

DISHWASHER INSTALLATION,  
OPERATION AND MAINTENANCE

FOR OPERATOR. DO NOT DISCARD

