

SPECIFICATIONS

Max Temperature	1700°F (927°C)
Input Voltage	120V
Hz	60
Amp Circuit Required	15 Amp
Power	1800W
Controller	Novus N20K48
Volume	1536 in ³
Internal Dimensions	16" wide x 6" tall x 16" deep
Max Ambient Temperature	95°F (35°C)

HOT SHOT®

The Hot Shot Oven is a state of the art, table-top, heat treating oven capable of reaching and holding temperatures up to 1700°F. Heat Treating Ovens can be used to heat such things as glass, cylinder heads, welded and carbon steel joints, pumps, various mechanical plates, ceramics, etc.

IMPORTANT SAFEGUARDS

READ ALL INSTRUCTIONS

POTENTIAL HAZARDS

- **Electrical shock hazard** – unplug the kiln from the electrical service before cleaning or servicing. Do not touch heating elements with anything
- **Burn hazard** – Always wear protective clothing, gloves, and eyewear when working around the kiln. Use special care when opening a hot kiln as the escaping heat can cause severe burns. Keep unsupervised children away from an operating kiln
- **Fire hazard** – Do not place the kiln on a combustible surface. Allow at least 3 inches of airspace around the kiln and do not store any flammable or combustible materials nearby

Fumes and/or smoke may be present during the kiln break-in period or during heating of certain materials. Be sure to provide adequate ventilation

Locate the kiln in a covered but well-ventilated area away from flammable materials. Do not operate the kiln outdoors or in wet conditions

CLEANING

The inside of your kiln can be vacuumed using a soft brush attachment to remove dust and debris. A vacuum with a HEPA filter is recommended. The outer surfaces can be wiped clean with a damp cloth or sponge. Do not use harsh cleaning chemicals on the painted surfaces of the kiln.

USER MAINTENANCE

The floor of your kiln is removable to allow for replacement due to wear and tear or to aid in set up of materials that will be fired in the kiln.

Service of any other components shall be done by an authorized Hot Shot Oven & Kiln service representative.

SAVE THESE INSTRUCTIONS



OVEN + KILN WARRANTY

All Hot Shot Oven & Kiln, oven and kilns are warranted against defects in material and workmanship for 3 years. Hot Shot Oven & Kiln will repair or replace (at our option), at no charge, any part(s) found to be faulty during the warranty period specified. The oven/kiln will be free of defects in workmanship and materials when used under normal and proper operating conditions. The oven and kiln warranty repairs must be performed by/at Hot Shot Oven & Kiln facility.

OBLIGATIONS OF THE ORIGINAL OWNER

Provide written proof of date of purchase. Notify Hot Shot Oven & Kilns immediately after defect has been discovered. Transportation of oven/kilns to Hot Shot Oven & Kiln is the responsibility of the original purchaser. Return transportation back to the customer is provided by Hot Shot Oven & Kiln when the oven/kiln is in-warranty.

FOR WARRANTY REPAIRS: Warranty repairs should be handled through Hot Shot Oven & Kiln who will arrange for any repairs or replacement of parts under the terms of this warranty. Otherwise, the defective part may be returned (postage prepaid) to Hot Shot Oven & Kiln at 2305 Stonebridge Rd, West Bend, WI 53095. If, after factory examination, the original part is found to be defective, a new or repaired part will be shipped prepaid by Hot Shot Oven & Kiln. If the entire oven is to be returned to the factory, all transportation costs will be done by the purchaser. The purchaser should notify Hot Shot Oven & Kiln (262) 361-4912 prior to shipping for a Return Materials Authorization (RMA) Number. Hot Shot Oven & Kiln will help advise if it is necessary to return the entire oven or only certain parts. Warranty work will be performed within 3 business days after defective part is returned to the factory. Hot Shot Oven & Kiln reserves the right, at its option, to replace the entire oven or any part of it in order to fulfill its obligation under this warranty.

THIS WARRANTY DOES NOT COVER:

- Ovens altered in any way, abuse or neglect, moisture, improper storage or installation.
- Ovens over fired (reaching temperature higher than melting point of ware inside oven) regardless of cause.
- Ovens operated on incorrect voltage. Improper electrical installation. Knife Blade furniture or ware other than Hot Shot Oven & Kiln made.
- Ovens used for salt firing.
- Ovens used for Nitriding.
- Ovens used for purposes other than the firing of heat-treating various metals.
- Ovens operated more than the temperature on the rating plate.
- Damage to Property or personal injury that may occur from ovens that are fired on or near wood floors or combustibles.
- Damage to property or personal injury that may occur from improper ventilation of the work area and building structure.

This warranty is in lieu of all other warranties, expressed, or implied.

EXCLUSIONS OF THE WARRANTY

This warranty does not cover any of the following: accident, misuse, fire, flood, and other acts of God, acts of terrorism, nor any contingencies beyond the control of Hot Shot Oven & Kiln, including but not limited to water damage, incorrect line voltage, improper installation, installation where this unit will not meet local electrical codes, missing or altered serial numbers, and service performed by an unauthorized facility. Hot Shot Oven & Kiln's liability for any damages caused in association with the use of Hot Shot Oven & Kiln's equipment shall be limited to the repair or replacement only of the Hot Shot Oven & Kiln's equipment. No person, agent, distributor, dealer, or company is authorized to modify, alter, or change the design of this merchandise without express written approval of Hot Shot Oven & Kiln.

Liability Limitation: In no event shall Hot Shot Oven & Kiln be liable or responsible for consequential, incidental or special damages resulting from or related in any manner to any Hot Shot Oven & Kiln product, third party installation(s), manufactured or distributed, or parts thereof.

Hot Shot Oven & Kiln does not accept returns on units that have been burned in or fired.

SAFETY RECOMMENDATIONS

Your heating element is made from Kanthal Ni-Chrome wire, allowing cold air to enter a hot oven will harden your element and make it become brittle. Never use compressed air or fans to force cool the oven, always close the door and let the oven cool on its own, this will keep your heating element annealed.

1. Install on a 15 amp 120V circuit.
2. Do not use the oven to cure paint or any other solvent borne products.
3. Do not use the oven for powder coat.
4. Use in a well ventilated area.
5. Wear protective clothing and protect thyself from burns.
6. Do not unplug the unit till it has fully cooled down.
7. Do not EVER put magnesium in the oven.
8. Do not exceed 1700°F.
9. Do not block any vents.
10. Keep the fan exhaust at least 3 inches from any wall or obstruction.
11. In the event the oven overheats, the oven will automatically shut down. Please contact our office at 262-361-4912 to work with our team on resetting your oven if shut down occurs.
12. Use caution when loading and unloading kiln while kiln is in operation.
13. Do not leave kiln unattended.
14. The thermocouple works best if its not crowded against your work. Give it as much room as practically possible. Avoid blocking the thermocouple from the sides, particularly both sides at once.

HOT SHOT®

HOT SHOT 16G PRO ELECTRICAL FEATURES

- TAP 4.3" color touch screen controller.
- Available wifi with mobile app.
- 40 amp rated SSR with convection heat sink.
- Kiln type "K" thermocouple.
- Easy to read slant top control panel.
- Heavy Duty cord.
- Fully grounded control and oven shell.

HOT SHOT 16G PRO MECHANICAL FEATURES

- Dual layer air plenum for external heat management and precise temperature control.
- Powder coated exterior shell.
- 14 Gauge Kanthal A-1 heating element.
- 6" H x 16" W x 16" D working chamber / 1536 cu-in.

HOT SHOT 16G PRO PERFORMANCE

Performance Features

- The Hot Shot oven is equipped with Cool-Touch Technology (patent pending). This provides a safe external temperature to allow for safer operation and protection of its surroundings.
- **HS-16G-PRO-120** - 120V 15-amp supply circuit required.
- 1800-watt heating element/15 amp total oven load.
- 1700°F/927°C max operating temperature **(120V Unit)**.
- Maximum ambient room temperature of 95°F (35°C).

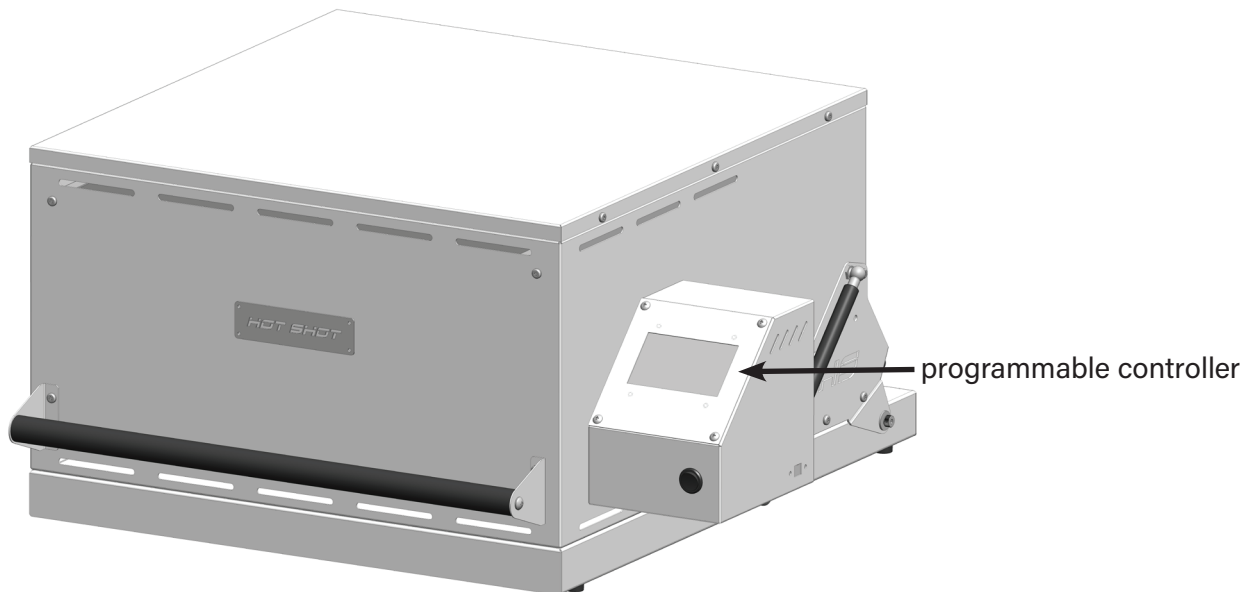

STARTING YOUR OVEN FOR THE FIRST TIME?

Please carefully remove all packing material from the inside of your oven. Visually check that the element hasn't been bumped or moved during shipping.

- DO NOT block any vents.
- Keep the back of the oven (fan unit) at least 3 inches away from a wall or other objects.
- DO NOT attempt to duct the exhaust of the fan unless the exhaust has a power vent compatible with the cfm of the fan.

Note: When the power switch is turned on, the screen will flash and go blank for 20-30 seconds as the controller begins to run through a complex initialization period in which it configures all the inputs, outputs, and the underlying file system. This is normal.

HS-16G-PRO WIFI SETUP

To skip to Running a Schedule Instructions, turn to page 8.

STEP 1:



From the home screen, Press "MENU"

STEP 4:

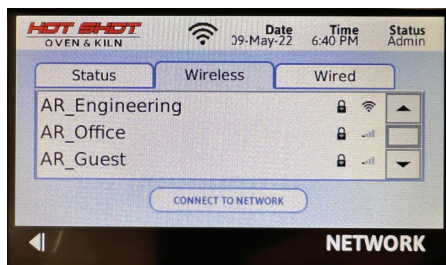

On the network screen, press "Wireless" and a list of available networks should appear. Select the appropriate network and press "CONNECT TO NETWORK"

STEP 2:

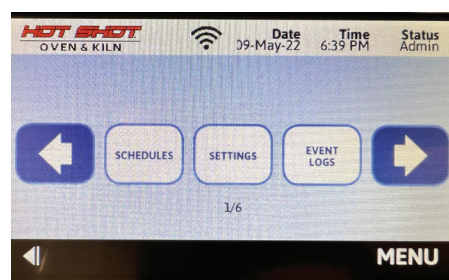

Scroll to and press "SETTINGS"

STEP 5:

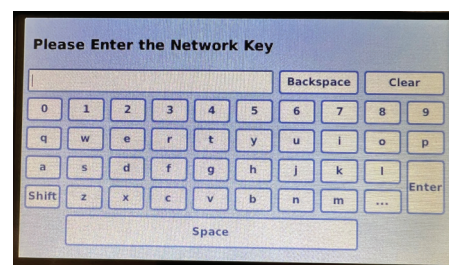

Enter the network password and press "ENTER"

STEP 3:

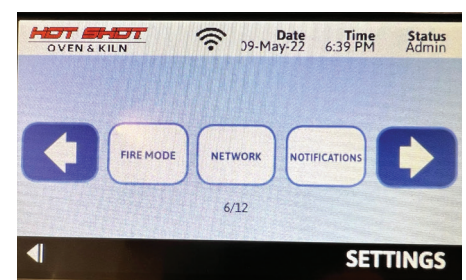

Scroll to and press "NETWORK"

STEP 6:

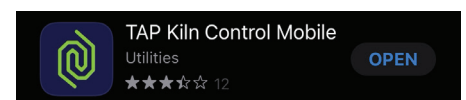

IMPORTANT: Turn of the main power switch and then turn back on to reboot the controller. It will not connect to the network until a reboot has been performed.

Search for **TAP Kiln Control Mobile** (iOS or Android) for remote monitoring or programming

RUNNING A SCHEDULE

STEP 1:



Once the home screen appears, press "START" to access the "SCHEDULE SELECTOR" screen.

STEP 2:

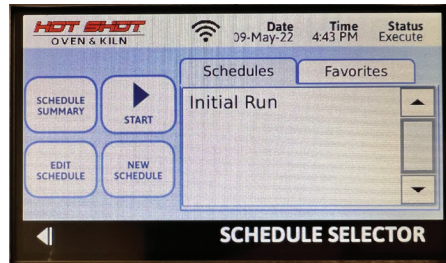

Highlight the schedule and press "START."

STEP 3:

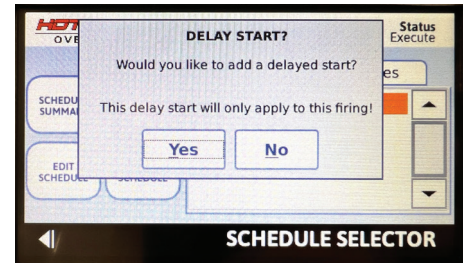

A prompt on the screen will ask if you want a delayed start. Press "NO".

STEP 4:

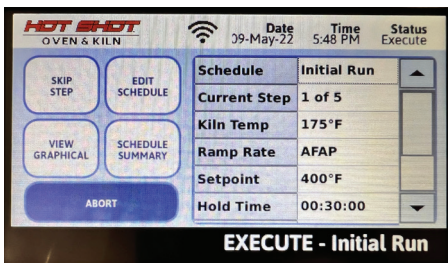

The oven will start, and the run screen will be displayed

Example Schedule:

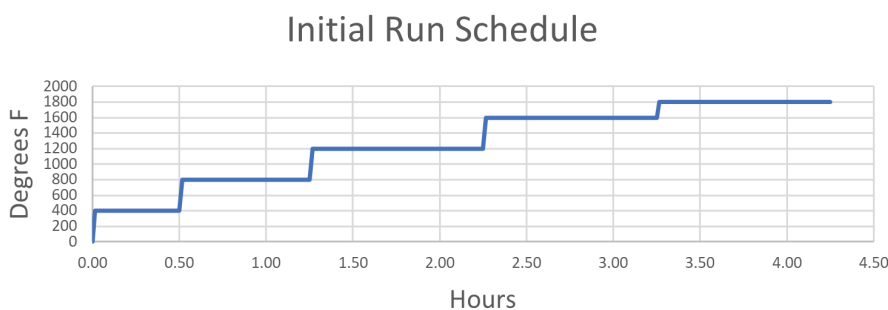

400°F for 30 minutes
800°F for 45 minutes
1200°F for 60 minutes
1600°F for 60 minutes
1800°F for 60 minutes

CREATING A CUSTOM SCHEDULE

STEP 1:



From the main screen, press "START"

STEP 2:

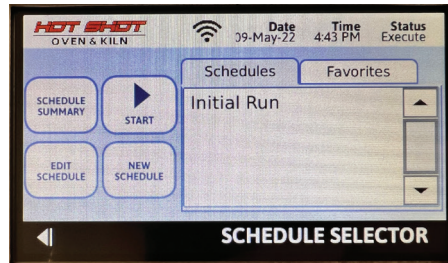

Once on the "Schedule Selector Screen", press "NEW SCHEDULE"

STEP 3:

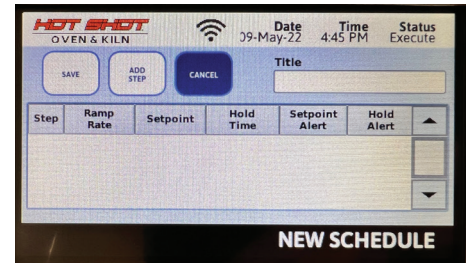

From the "NEW SCHEDULE" screen, enter a title, then press "ADD STEP"

STEP 4:

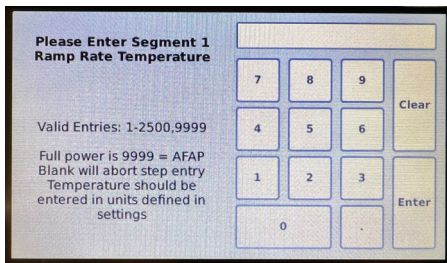

Enter ramp rate in degrees per hour. For maximum rate enter 9999

AFAP = As Fast As Possible

STEP 5:

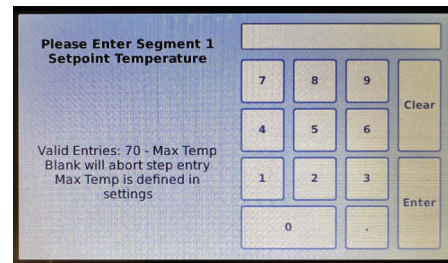

Enter setpoint temperature in degrees F.

STEP 6:

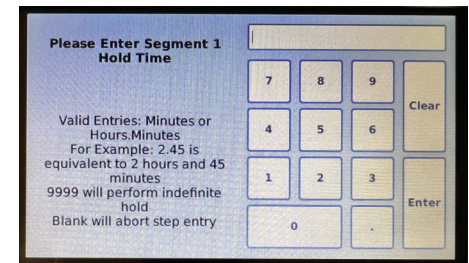

Enter segment hold time (Soak) in minutes or hours. Input examples below: 5 = 5 min, 5.0 = 5 hrs, 5.45 = 5 hrs and 45 min, 90 = 1.5 hrs

STEP 7:



Adding a setpoint alert will sound an alarm when the setpoint temperature is reached.

STEP 8:

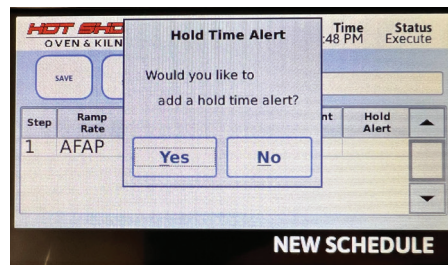

Adding a hold time alert will sound an alarm when the segment hold time has completed.

STEP 9:

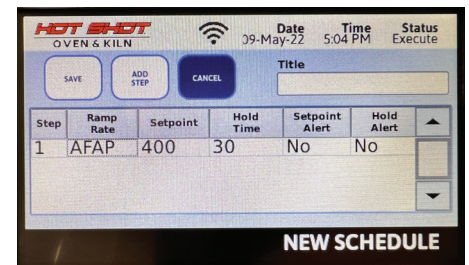

The "NEW SCHEDULE" screen will appear. You can either save the schedule or add additional steps

Settings: Additional settings can be accessed in the menu screen.

- Delete schedules
- Change date & time
- Change display brightness
- Change Units (°F or °C)
- Change time format (12h or 24h)
- Add Cost per Kwh for firing