

ALPINE
INTERNATIONAL



- Watch Bands ■ Jewellery Packaging ■ Fashion Jewellery ■ Watch Batteries
- Bracelets de montres ■ Emballages pour bijoux
- Bijoux de mode ■ Piles de montres

www.alpineselection.com

2024 - 2025

Exclusive Canadian distributor for:

RIOS1931

RIEMER OSWALD

MADE IN GERMANY

Dear Valued Customer,

Alpine International is pleased to introduce our 2024-2025 catalogue with an array of new and unique products specifically curated with our customers in mind. We are committed to consistently expanding our collection and are excited to announce the addition of Maxell & Renata watch batteries to our 2024/25 catalogue. We are proud of our extraordinary selection of high-quality watch bands, watch winders, gift items, medical ID bracelets and fashion jewellery, all of which are now available to all our customers across Canada and the United States. We invite you to browse through a copy of our catalogue or simply download a PDF copy on our website www.alpineselection.com. Merchandise is available to order either through our distributors, or directly for purchase through Alpine International.

Alpine International values your continued support and is committed to providing you with the best quality products and customer service. Our number one priority will always be to support our customer's objectives by providing the best products along with a great customer service experience.

Sincerely,

Raj Tilokani

President, Alpine International

Cher client,

Alpine International a le plaisir de vous présenter son catalogue 2024-2025 avec un éventail de produits nouveaux et uniques, spécialement conçus pour nos clients. Nous nous engageons à élargir constamment notre collection et sommes ravis d'annoncer l'ajout des piles de montres Maxell et Renata à notre catalogue 2024/25. Nous sommes fiers de notre sélection extraordinaire de bracelets de montres de haute qualité, de remontoirs, d'articles-cadeaux, de bracelets d'identification médicale et de bijoux fantaisie, qui sont désormais disponibles pour tous nos clients au Canada et aux États-Unis. Nous vous invitons à consulter une copie de notre catalogue ou à télécharger une copie PDF sur notre site web www.alpineselection.com. Ces produits peuvent être commandés soit auprès de nos distributeurs, soit directement auprès de Alpine International.

Alpine International apprécie votre soutien indéfectible et s'engage à vous fournir des produits et un service clientèle de la plus haute qualité. Notre principale priorité sera toujours de soutenir les objectifs de nos clients en leur fournissant les meilleurs produits ainsi qu'un service à la clientèle de haute qualité.

Je vous prie d'agréer, Madame, Monsieur, l'expression de mes salutations les plus distinguées,

Cordialement,

Raj Tilokani

Président, Alpine International

- 8-28 RIOS1931 Watch Band Collection / Collection de bracelets de montres RIOS1931
- 29-69 Alpine Watch Bands & Accessories / Collection de Bracelets et accessoires de montres Alpine
- 70-71 Watch Tools and Batteries / Outils d'horloger et piles de montres
- 72-73 Boxy Watch Winders Collection / Collection de remonte-montres Boxy
- 74-75 Watch Box Collection / Collection de boîtiers
 - 76 Pocket Watch Collection / Collection de montre de poche
 - 77 Personalized Quartz Gift Clocks / Horloges personnalisées
- 78-81 Medical ID Bracelets & Pendants / Bracelets et pendentifs d'identification médicale [à graver]
- 82-83 Titanium & Steel Bracelets / Bracelets en titane et en acier inoxydable
 - 84 Pendants & Chains / Pendentifs et Chaînes
 - 85 Magnetic Bracelets / Bracelets aimantés
- 86-88 Rings / Joncs
 - 89 Engravable Cufflinks/ Boutons de manchette à graver
 - 90 Tie Bars / Pincés à cravates
 - 91 Cufflink & Tie Bar Sets / Ensembles de Boutons de manchettes et de Pincés à cravates
 - 92 Money Clips / Pincés à billets de banques
- 93-94 Engravable Key Chains / Porte-clés personnalisés gravés
Business Card Holders / Porte-cartes professionnelles
- 95-99 Jewellery Packaging / Emballages pour bijoux

Since 1931

Depuis 1931

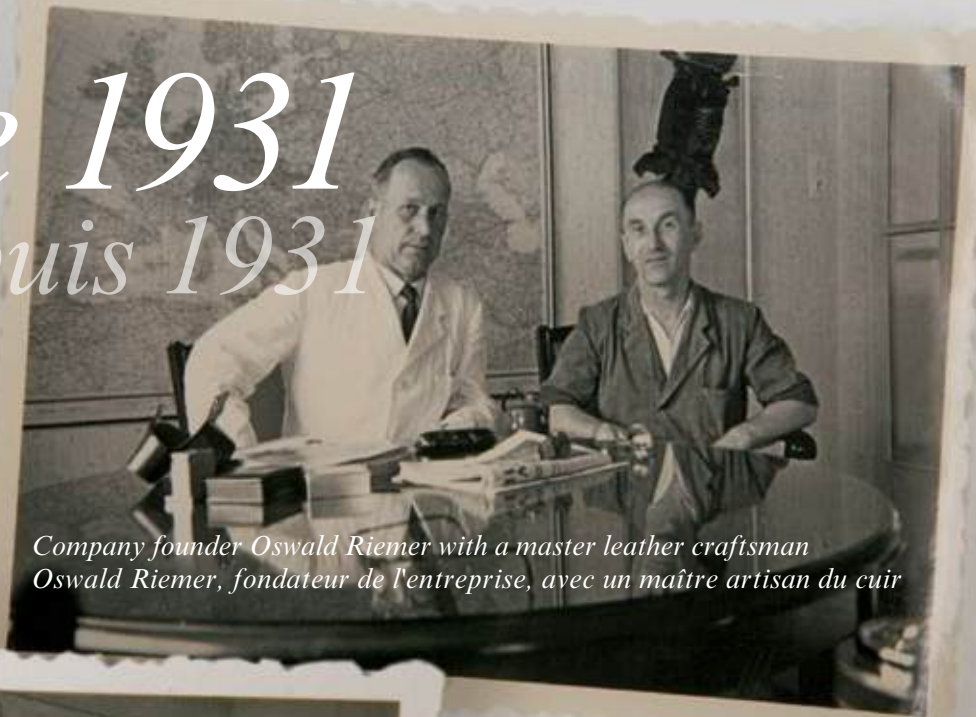

*Company founder Oswald Riemer with a master leather craftsman
Oswald Riemer, fondateur de l'entreprise, avec un maître artisan du cuir*



*Group picture of the staff of 1938
Photo de groupe du personnel de 1938*

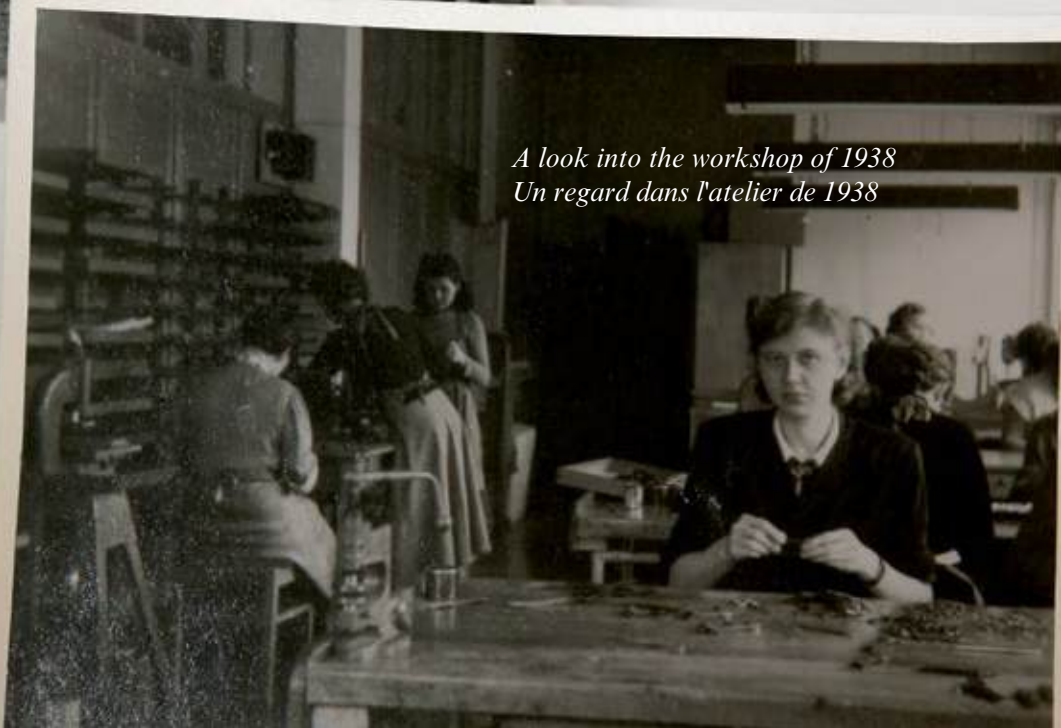

*A look into the workshop of 1938
Un regard dans l'atelier de 1938*

Steeped in tradition, inspired by the zeitgeist.

Imprégné de tradition, inspiré par les tendances du temps.

When you purchase a RIOS1931 watch strap you are acquiring a high quality craft product. Since the foundation of our company by watchmaker Oswald Riemer in 1931, we have always used the Swiss full-bugg technique. Then as now, this is a method designed to ensure the highest level of quality. As a family business in its third generation, we still have the same philosophy as originally defined by Oswald Riemer: »Preserve skilled craftsmanship while focusing on fashion and meeting the technical requirements of the day.« The combination of traditional, handcrafted perfection while constantly evolving has made the watch straps of RIOS1931 a unique product worldwide.

Lorsque vous achetez un bracelet de montre RIOS1931, vous faites l'acquisition d'un produit artisanal de haute qualité. Depuis la fondation de notre entreprise en 1931 par l'horloger Oswald Riemer, nous avons toujours utilisé la technique suisse du bracelet intégral. À l'époque comme aujourd'hui, il s'agit d'une méthode conçue pour garantir le plus haut niveau de qualité.

En tant qu'entreprise familiale de troisième génération, nous avons toujours la même philosophie que celle définie à l'origine par Oswald Riemer : « Préserver le savoir-faire artisanal tout en se concentrant sur la mode et en répondant aux exigences techniques du moment ». La combinaison de la perfection traditionnelle et artisanale tout en évoluant constamment a fait des bracelets de montre de RIOS1931 un produit unique au monde.



| Guido Satzger |

| Andreas Riemer |

Andreas Riemer (right), President and third-generation member of the family which gave the company its name, and Guido Satzger (left), CEO, are marking the presentation of the certificate awarded by the City of Augsburg for »Quality – made in Augsburg« by the Lord Mayor Dr. Kurt Gribl on the 26th June 2017 in the Golden Hall in the City of Augsburg.

Andreas Riemer (à droite), président et membre de la troisième génération de la famille qui a donné son nom à l'entreprise, et Guido Satzger (à gauche), directeur général, marquent la remise du certificat décerné par la ville d'Augsbourg pour la « Qualité - produite à Augsburg » par le Lord-Maire Dr. Kurt Gribl le 26 juin 2017 dans la Salle Dorée de la ville d'Augsbourg.

Made in Germany

Fabriqué en Allemagne

The guarantee for the consistently high quality of our watch straps is given by the business location itself - Germany.

We still train our employees ourselves, in our workshop. During the years of training, they acquire the expertise necessary to make a RIOS1931 watch strap.

It takes a trained eye and a great deal of skill to select the materials needed for the production of our watch straps. We use only the highest grades of leather available. You can be sure of a luxury product of the highest quality, authenticity and longevity when purchasing an RIOS1931 strap.

La garantie d'une qualité élevée et constante de nos bracelets de montres est assurée par le site même de l'entreprise - Allemagne. Nous formons toujours nos employés nous-mêmes, dans notre atelier. Au cours de ces années de formation, ils acquièrent le savoir-faire nécessaire à la fabrication d'un bracelet de montre RIOS1931. La sélection des matériaux nécessaires à la production de nos bracelets de montre requiert un œil exercé et beaucoup de savoir-faire. Nous n'utilisons que les meilleures qualités de cuir disponibles. En achetant un bracelet de montre RIOS1931, vous avez la garantie d'un produit de luxe de la plus haute qualité, d'authenticité et de longévité.





Original and individual

Making high-quality watch straps is a craft that is still very present and alive. We aspire to maintain the original values of the business and to preserve traditional handicraft techniques. With an RIOS1931 watch strap, you are giving your watch a touch of the original in a world of mass production and ever more uniformity.

Original et individuel

La fabrication de bracelets de montres de haute qualité est un artisanat encore très présent et vivant. Nous aspirons à maintenir les valeurs originales de l'entreprise et à préserver les techniques artisanales traditionnelles. Avec un bracelet de montre RIOS1931, vous donnez à votre montre une touche d'originalité dans un monde de production de masse et de standardisation permanente.



Mod. **R250** | **Ambassador**

Genuine Alligator Leather, matt finish, flank | »Art Manuel« |
Seam: cream white | Thickness of strap: approx. 7.0 mm to 3.0 mm

Cuir d'alligator véritable, finition mate, flanc » Art Manuel »
Couture : blanc crème | Épaisseur du bracelet :
environ 7,0 mm à 3,0 mm

MADE IN
GERMANY



Cross-section: | Coupe transversale :



» ROUND « | » ROND «

Length Longueur (mm)		R
		114 82
Width Largeur		
Lug / Patte	Buckle / Boucle	
18 mm	16 mm	✓
19 mm	16 mm	✓
20 mm	18 mm	✓
22mm	20mm	✓



250 **1**

black
Noir

250 **2D**

dark brown
Marron
foncé

250 **3**

tan
Bronze

250 **7**

blue
Bleu

Mod. **R249** | **Heritage**

Genuine Alligator Leather, glossy finish, flank | »Art Manuel« |
Seam: matching stitching | Thickness of strap: approx.
5.5 mm to 3.0 mm

Cuir d'alligator véritable, finition lustrée, flanc |
» Art Manuel » |

Couture : points de couture assortis | Épaisseur du bracelet :
environ 5,5 mm à 3,0 mm

MADE IN
GERMANY



Cross-section: | Coupe transversale :



» ROUND « | » ROND «

Length Longueur (mm)		R
		114 82
Width Largeur		
Lug / Patte	Buckle / Boucle	
18 mm	16 mm	✓
19 mm	16 mm	✓
20 mm	18 mm	✓
22 mm	18 mm	✓



249 **1**

black
Noir

249 **2**

brown
Marron

249 **2D**

dark brown
Marron
foncé

249 **7**

blue
Bleu



Mod. R272 | Senator

Genuine Alligator Leather, matt finish, fullcut | »Art Manuel« |
 »Saddler's Seam (Hand Seam)« |
 Seam: matching stitching | Thickness of strap: approx.
 3.0 mm to 2.5 mm

Cuir d'alligator véritable, finition mate, coupe intégrale |
 » Art Manuel » | » Couture du sellier (Couture
 à la main) « |

Couture : points de couture assortis | Épaisseur du bracelet :
 environ 3,0 mm à 2,5 mm

MADE IN
GERMANY



Length Longueur (mm)		R
		114 82
Width Largeur		
Lug / Patte	Buckle / Boucle	
18 mm	16 mm	✓
19 mm	16 mm	✓
20 mm	16 mm	✓
21 mm	18 mm	✓

Cross-section: | Coupe transversale :



» SQUARE « | » CARRÉ «



272 1 black Noir
 272 2D dark brown Marron foncé
 272 3 tan Bronze
 272 7 blue Bleu



Mod. R273 | Premier

Genuine Alligator Leather, glossy finish, fullcut | »Art Manuel« |
 »Saddler's Seam (Hand Seam)« |
 Seam: matching stitching | Thickness of strap: approx. 3.0 mm to 2.5 mm

Cuir d'alligator véritable, finition lustrée, coupe intégrale |
 » Art Manuel » | » Couture du sellier (Couture à la main)

Couture : points de couture assortis | Épaisseur du bracelet :
 environ 3,0 mm à 2,5 mm

MADE IN
GERMANY



Length Longueur (mm)		R
		114 82
Width Largeur		
Lug / Patte	Buckle / Boucle	
18 mm	16 mm	✓
19 mm	16 mm	✓
20 mm	18 mm	✓

Cross-section: | Coupe transversale :

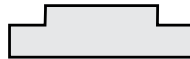

» SQUARE « | » CARRÉ «



273 1 black Noir
 273 2 brown Marron
 273 2D dark brown Marron foncé
 273 7 blue Bleu

Mod. R396 Master



Genuine Alligator Leather, matt finish, fullcut | For folding buckle |
 »Art Manuel« |
 »Saddler's Seam (Hand Seam)« | Seam: matching stitching |
 Thickness of strap: approx. 5.5 mm to 2.0 mm
 Cuir d'alligator véritable, finition mate, coupe intégrale |
 pour boucle rabattable »Art Manuel« |
 »Couture du sellier (Couture à la main)« | Couture : points de
 couture assortis | Épaisseur du bracelet : environ 5,5 mm à 2,0 mm

MADE IN
GERMANY



– Technical specification –
 RIOS1931 watch strap, particularly suitable for watches of the brand »Omega«
 – Spécification technique –
 RIOS1931 Bracelet de montre,
 particulièrement adapté aux
 montres de marque «Omega»



396 1 black Noir
 396 2D dark brown Marron foncé
 396 13 orange Orange

Length Longueur (mm)		M
		104 100
Width Largeur		
Lug / Patte	Buckle / Boucle	
19 mm	16 mm	✓
20 mm	18 mm	✓
22 mm	18 mm	✓

Cross-section: | Coupe transversale :



» ROUND « | » ROND «

Mod. R252 Superior



Genuine Alligator Leather, matt finish, flank | »Art Manuel« |
 Seam: matching stitching | Thickness of strap: approx. 7.0 mm auf 3.0 mm
 Cuir d'alligator véritable, finition mate, flanc » Art Manuel «
 Couture : blanc crème | Épaisseur du bracelet :
 environ 7,0 mm à 3,0 mm

MADE IN
GERMANY



Cross-section: | Coupe transversale :



» ROUND « | » ROND «



252 1 black Noir
 252 2 brown Marron
 252 7 blue Bleu

Length Longueur (mm)		R
		114 82
Width Largeur		
Lug / Patte	Buckle / Boucle	
18 mm	16 mm	✓
19 mm	16 mm	✓
20 mm	18 mm	✓
22mm	20mm	✓

Mod. **R222** | Avenue



Genuine Teju Lizard Leather, glossy finish | »Art Manuel«
 Seam: matching stitching | Thickness of strap:
 approx. 3.5 mm to 3.0 mm

Cuir de lézard de Teju véritable, finition lustrée |
 »Art Manuel«
 Couture : points de couture assortis | Épaisseur
 du bracelet : environ 3,5 mm
 à 3,0 mm

MADE IN
GERMANY



Length Longueur (mm)		R
		114 82
Width Largeur		
Lug / Patte	Buckle / Boucle	
16 mm	14 mm	✓
18 mm	16 mm	✓
20 mm	18 mm	✓

Cross-section: | Coupe transversale :

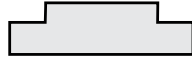

» SQUARE « | » CARRÉ «



222 **1**
black
Noir

222 **2**
brown
Marron



222 **4**
red
Rouge

222 **5**
burgundy
Bourgogne

222 **7**
blue
Bleu

222 **12**
grey
Gris



Mod. **R276** | President

Genuine Alligator Leather, matt finish, fullcut | »Art Manuel«
 »Saddler's Seam (Hand Seam)«
 Seam: matching stitching | Thickness of strap: approx. 5.5 mm to 3.0 mm

Cuir d'alligator véritable, finition mate, coupe intégrale | » Art Manuel
 » | » Couture du sellier (Couture à la main) «
 Couture : points de couture assortis | Épaisseur du bracelet :
 environ 5,5 mm à 3,0 mm

MADE IN
GERMANY



Length Longueur (mm)		R
		104 100
Width Largeur		
Lug / Patte	Buckle / Boucle	
18 mm	16 mm	✓
19 mm	16 mm	✓
20 mm	18 mm	✓
22 mm	18 mm	✓

Cross-section: | Coupe transversale :



» ROUND « | » ROND «



276 **1**
black
Noir

276 **2**
brown
Marron

276 **2D**
dark brown
Marron
foncé

276 **3**
tan
Bronze

276 **7**
blue
Bleu

Mod. R51 | New Orleans



Embossed Alligator Grain on Genuine Cow Leather, matt finish | »Art Manuel« |
Seam: cream white | Thickness of strap: approx. 6.0 mm to 3.0 mm

Cuire d'alligator gaufré sur cuir de vachette véritable, finition mate |
» Art Manuel « |

Couture : blanc crème | Épaisseur du bracelet :
environ 6,0 mm
à 3,0 mm

MADE IN
GERMANY



Length Longueur (mm)		R	L
		114 82	124 92
Width Largeur			
Lug / Patte	Buckle / Boucle		
16 mm	14 mm	✓	✓
18 mm	16 mm	✓	✓
19 mm	16 mm	✓	
20 mm	18 mm	✓	✓
22 mm	18 mm	✓	✓

Cross-section: | Coupe transversale :



» ROUND « | » ROND «



51 1 black Noir
51 2 brown Marron
51 2D dark brown Marron
51 3 tan Bronze



51 5 burgundy Bourgogne
51 6 pink Rose
51 7D dark blue Bleu foncé
51 12 grey Gris
51 13 orange Orange



Mod. R50 | Louisiana

Embossed Alligator Grain on Genuine Cow Leather,
matt finish | »Art Manuel« |

Seam: matching stitching | Thickness of strap:
approx. 6.0 mm to 3.0 mm

Cuir d'alligator gaufré sur cuir de vachette
véritable, finition mate | » Art Manuel «

Couture : points de couture assortis |
Épaisseur du bracelet : environ 6,0
mm à 3,0 mm

MADE IN
GERMANY



Length Longueur (mm)		R	L
		114 82	124 92
Width Largeur			
Lug / Patte	Buckle / Boucle		
16 mm	14 mm	✓	✓
18 mm	16 mm	✓	✓
20 mm	16 mm	✓	✓
22 mm	18 mm	✓	✓

Cross-section: | Coupe transversale :



» ROUND « | » ROND «



50 0 white Blanc
50 1 black Noir



50 2 brown Marron
50 2D dark brown Marron foncé
50 5 burgundy Bourgogne
50 12 grey Gris

Mod. R102 | Toscana



Genuine Calfskin |
Seam: matching stitching | Thickness of strap:
approx. 3.5 mm to 3.0 mm

Cuir de veau véritable |
Couture : points de couture assortis |
Épaisseur du bracelet :
environ 3,5 mm à 3,0 mm

MADE IN
GERMANY

Length Longueur (mm)		R	R
		104 72	114 82
Width Largeur			
Lug/Patte	Buckle/Boucle		
12 mm	10 mm	✓	
14 mm	12 mm	✓	
16 mm	14 mm		✓
18 mm	16 mm		✓
19 mm	16 mm		✓
20 mm	18 mm		✓
22 mm	20 mm		✓

Cross-section: | Coupe transversale :



» SQUARE « | » CARRÉ «



102 1
black
Noir

102 2D
dark brown
Marron
foncé



102 3
tan
Bronze

102 4
red
Rouge

102 6
pink
Rose

102 7
blue
Bleu



Mod. R45 | French

Genuine Cowhide |
Seam: matching stitching | Thickness of strap: approx.
3.0 mm to 2.7 mm

Cuir de vachette véritable |
Couture : points de couture assortis |
Épaisseur du bracelet :
environ 3,0 mm à 2,7 mm

MADE IN
GERMANY

Length Longueur (mm)		R	R	L
		104 72	114 82	124 92
Width Largeur				
Lug/Patte	Buckle/Boucle			
14 mm	12 mm	✓		
16 mm	14 mm		✓	
18 mm	16 mm		✓	✓
19 mm	16 mm		✓	✓
20 mm	18 mm		✓	✓
22 mm	18 mm		✓	✓

Cross-section: | Coupe transversale :

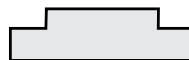

» SQUARE « | » CARRÉ «



45 0
white
Blanc

45 1
black
Noir



45 3
tan
Bronze

45 4
red
Rouge

45 7
blue
Bleu

45 13
orange
Orange



Mod. R52 | Orlando

*Embossed Alligator Grain on Genuine Cow Leather, matt finish | »Art Manuel« |
Seam: matching stitching | Thickness of strap: approx. 3.5 mm to 2.7 mm*

*Cuir d'alligator gaufré sur cuir de vachette véritable, finition mate | » Art Manuel » |
Couture : points de couture assortis | Épaisseur du bracelet : environ 3,5 mm à 2,7 mm*

MADE IN GERMANY



Length Longueur (mm)		R	R
		104 72	114 82
Width Largeur			
Lug/Patte	Buckle/Boucle		
12 mm	10 mm	✓	
14 mm	12 mm	✓	
16 mm	14 mm		✓
18 mm	16 mm		✓
19 mm	16 mm		✓
20 mm	18 mm		✓

Cross-section: | Coupe transversale :



» SQUARE « | » CARRÉ «



52 1 **52 2D** **52 3** **52 5** **52 7D**
*black dark brown tan burgundy dark blue
 Noir Marron Bronze Bourgogne Bleu foncé*



Mod. R64 | Colorado

*Genuine Buffalo Leather | »Art Manuel« |
Seam: matching stitching | Thickness of strap: approx. 6.0 mm to 3.0 mm*

*Cuir de buffle véritable | » Art Manuel » |
Couture : points de couture assortis | Épaisseur du bracelet : environ 6,0 mm à 3,0 mm*

MADE IN GERMANY



Length Longueur (mm)		R
		114 82
Width Largeur		
Lug/Patte	Buckle/Boucle	
18 mm	16 mm	✓
20 mm	18 mm	✓
22 mm	18 mm	✓

Cross-section: | Coupe transversale :



» ROUND « | » ROND «



64 1 **64 2D** **64 3**
*black dark brown tan
 Noir Marron Bronze*



|Mod. R186| Maryland

Genuine Canvas | Vintage | »Saddler's Seam (Hand Seam)« |
Seam: matching stitching | Thickness of strap: approx.
4.0 mm to 3.0 mm

Canevas authentique | Classique | » Couture du sellier «
(couture à la main) |

Couture : points de couture assortis | Épaisseur du bracelet :
environ 4,0 mm à 3,0 mm

MADE IN
GERMANY



Length Longueur (mm)		R
		114 82
Width Largeur		
Lug / Patte	Buckle / Boucle	
22 mm	22 mm	✓
24 mm	24 mm	✓

Cross-section: | Coupe transversale :



» BLOCK « | » BLOC «



186 **1**

black
Noir

186 **2D**

dark brown
Marron
foncé

186 **8**

green
Vert

186 **12**

grey
Gris



|Mod. R385| Typhoon

Genuine Buffalo Leather |

Seam: cream white | Thickness of strap: approx. 3.5 mm to 3.5 mm

Cuir de buffle véritable |

Couture : blanc crème | Épaisseur du bracelet :
environ 3,5 mm à 3,5 mm

MADE IN
GERMANY

Length Longueur (mm)		R
		114 82
Width Largeur		
Lug / Patte	Buckle / Boucle	
20 mm	18 mm	✓
21 mm	18 mm	✓
22 mm	18 mm	✓

Cross-section: | Coupe transversale :



» BLOCK « | » BLOC «



385 **1**

black
Noir

385 **2D**

dark brown
Marron
foncé

385 **3**

tan
Bronze



Mod. R147 | Polo

Genuine Cow Leather with rubber grip | »Water resistant« |
»Art Manuel« |

Seam: cream white | Thickness of strap: approx. 6.0 mm to 3.0 mm

Cuir de vachette véritable, bandes en caoutchouc | « Résistant à l'eau » |
« Art Manuel » |

Couture : blanc crème | Épaisseur du bracelet :
environ 6,0 mm à 3,0 mm

MADE IN
GERMANY



Length Longueur (mm)		R
		114 82
Width Largeur		
Lug / Patte	Buckle / Boucle	
18 mm	16 mm	✓
20 mm	18 mm	✓
22 mm	18 mm	✓

Cross-section: | Coupe transversale :



» ROUND « | » ROND «



147 **1**
black
Noir



Mod. R159 | Bedford

Genuine Vintage Leather | »Saddler's Seam (Hand Seam)« |

Seam: cream white | Thickness of strap: approx. 2.7 mm to 2.7 mm

Cuir véritable classique | » Couture du sellier « (couture à la main) |

Couture : blanc crème | Épaisseur du bracelet : environ 2,7 mm à 2,7 mm

MADE IN
GERMANY



Length Longueur (mm)		R
		114 82
Width Largeur		
Lug / Patte	Buckle / Boucle	
18 mm	16 mm	✓
20 mm	16 mm	✓
22 mm	18 mm	✓

Cross-section: | Coupe transversale :

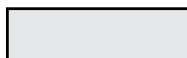

» BLOCK « | » BLOC «



159 **1** 159 **2** 159 **2D** 159 **3** 159 **12**
black brown dark brown tan grey
Noir Marron Marron Bronze Gris
foncé

- RIOS1931 Saddler's Seam -
Sewed from inside!
- RIOS1931 Couture du sellier -
Cousu de l'intérieur
- Every watch strap is unique -
The patina of the vintage leather can strongly vary.
- Chaque bracelet de montre est unique -
La patine du cuir classique peut varier considérablement.

Mod. R175 | York



Genuine Vintage Leather | »Art Manuel« |
 Seam: cream white | Thickness of strap: approx. 7.0 mm to 3.0 mm

Cuir véritable classique | « Art Manuel » |
 Couture : blanc crème | Épaisseur du bracelet : environ
 7,0 mm à 3,0 mm

MADE IN
GERMANY



		R
Length Longueur (mm)		114 82
Width Largeur		
Lug / Patte	Buckle / Boucle	
20 mm	18 mm	✓
22 mm	18 mm	✓

Cross-section: | Coupe transversale :



» ROUND « | » ROND «

– Every watch strap is unique –
 The patina of the vintage leather can strongly vary.
 – Chaque bracelet de montre est unique –
 La patine du cuir classique peut varier considérablement.



175 1
black
Noir

175 2
brown
Marron

175 2D
dark brown
Marron
foncé

175 3
tan
Bronze

175 12
grey
Gris



Mod. R152 | Franklin

Genuine Suede |
 Seam: matching stitching | Thickness of strap: approx. 3.5 mm to 3.0 mm

Daim véritable |
 Couture : points de couture assortis | Épaisseur du bracelet :
 environ 3,5 mm à 3,0 mm

MADE IN
GERMANY

		R
Length Longueur (mm)		114 82
Width Largeur		
Lug / Patte	Buckle / Boucle	
18 mm	16 mm	✓
20 mm	16 mm	✓
22 mm	18 mm	✓

Cross-section: | Coupe transversale :

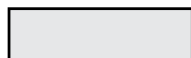

» BLOCK « | » BLOC «



152 1
black
Noir

152 2D
dark brown
Marron
foncé

152 3
tan
Bronze

152 12
grey
Gris

|Mod. R194| Chesterfield



Genuine Vintage Leather with two rivets |
Seam: cream white | Thickness of strap: approx. 4.0 mm to 4.0 mm

Cuir véritable classique avec deux rivets |
Couture : blanc crème | Épaisseur du bracelet :
environ 4,0 mm à 4,0 mm

M A D E I N
G E R M A N Y

– Every watch strap is unique –
The patina of the vintage leather can strongly vary.
– Chaque bracelet de montre est unique –
La patine du cuir classique peut varier considérablement.

Length Longueur (mm)		R
		114 82
Width Largeur		
Lug / Patte	Buckle / Boucle	
22 mm	22 mm	✓
24 mm	24 mm	✓

Cross-section: | Coupe transversale :

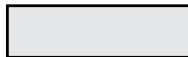

» BLOCK « | » BLOC «



194 **1** 194 **2** 194 **2D** 194 **3** 194 **12**
black brown dark brown tan grey
Noir Marron Marron Bronze Gris
foncé



|Mod. R190| Oxford

Genuine Vintage Leather |
Seam: cream white | Thickness of strap: approx. 4.0 mm to 4.0 mm

Cuir véritable classique |
Couture : blanc crème | Épaisseur du bracelet :
environ 4,0 mm à 4,0 mm

M A D E I N
G E R M A N Y

– Every watch strap is unique –
The patina of the vintage leather can strongly vary.
– Chaque bracelet de montre est unique –
La patine du cuir classique peut varier considérablement.

Length Longueur (mm)		R
		114 82
Width Largeur		
Lug / Patte	Buckle / Boucle	
20 mm	18 mm	✓
22 mm	22 mm	✓
24 mm	24 mm	✓

Cross-section: | Coupe transversale :



» BLOCK « | » BLOC «



190 **1** 190 **2** 190 **2D**
black brown dark brown
Noir Marron Marron
foncé

Mod. R179 | Birmingham



Genuine Vintage Leather |
Seam: cream white | Thickness of strap: approx. 3.0 mm to 3.0 mm

Cuir véritable classique |
Couture : blanc crème | Épaisseur du bracelet :
environ 3,0 mm à 3,0 mm

– Every watch strap is unique –
The patina of the vintage leather can strongly vary.
– Chaque bracelet de montre est unique –
La patine du cuir classique peut varier considérablement.

MADE IN
GERMANY

Length Longueur (mm)		R
		114 82
Width Largeur		
Lug/Patte	Buckle/Boucle	
20 mm	20 mm	✓
22 mm	22 mm	✓

Cross-section: | Coupe transversale :

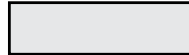

» BLOCK « | » BLOC «



179 1 black Noir
179 2 brown Marron
179 2D dark brown Marron foncé
179 3 tan Bronze
179 12 grey Gris



Mod. R188 | Derby



Genuine Vintage Leather |
Seam: matching stitching | Thickness of strap: approx.
6.0 mm to 3.0 mm

Cuir véritable classique |
Couture : points de couture assortis | Épaisseur du bracelet :
environ 6,0 mm à 3,0 mm

– Every watch strap is unique –
The patina of the vintage leather can strongly vary.
– Chaque bracelet de montre est unique –
La patine du cuir classique peut varier considérablement.

MADE IN
GERMANY

Length Longueur (mm)		R
		114 82
Width Largeur		
Lug/Patte	Buckle/Boucle	
22 mm	22 mm	✓
24 mm	22 mm	✓

Cross-section: | Coupe transversale :



» ROUND « | » ROND «



188 1 black Noir
188 2 brown Marron
188 2D dark brown Marron foncé
188 3 tan Bronze
188 12 grey Gris



Mod. R42 | Bolivia

Embossed Teju Lizard Grain on Genuine Cow Leather |
Seam: no stitching | Thickness of strap: approx. 2.5 mm to 2.5 mm

Grain de lézard Têju gaufré sur cuir de vachette véritable |
Couture : aucune couture | Épaisseur du bracelet :
environ 2,5 mm à 2,5 mm

MADE IN
GERMANY

Length Longueur (mm)		R	R
		104 72	114 82
Width Largeur			
Lug / Patte	Buckle / Boucle		
12 mm	10 mm	✓	
14 mm	12 mm	✓	
16 mm	14 mm		✓
18 mm	16 mm		✓
20 mm	18 mm		✓

Cross-section: | Coupe transversale :



» LIGHT ROUND « |
» LÉGÈREMENT ARRONDI «



42 1 black Noir
42 2D dark brown Marron foncé
42 3 tan Bronze
42 4 red Rouge
42 7 blue Bleu



Mod. R35 | Miami

Embossed Alligator Grain on Genuine Cow Leather, matt finish |
Seam: no stitching | Thickness of strap: approx. 2.0 mm to 2.0 mm

Grain d'alligator gaufré sur cuir de vachette véritable,
finition mate |

Couture : aucune couture | Épaisseur du bracelet :
environ 2,0 mm à 2,0 mm

MADE IN
GERMANY

Length Longueur (mm)		R	R
		104 72	114 82
Width Largeur			
Lug / Patte	Buckle / Boucle		
12 mm	10 mm	✓	
14 mm	12 mm	✓	
16 mm	14 mm		✓
18 mm	16 mm		✓
20 mm	18 mm		✓

Cross-section: | Coupe transversale :



» BLOCK « | » BLOC «



35 0 white Blanc
35 1 black Noir
35 2D dark brown Marron foncé
35 3 tan Bronze
35 7 blue Bleu

Mod. R200 | Moscow



Genuine Russia Leather | »Art Manuel« |
Seam: matching stitching | Thickness of strap: approx.
6.0 mm to 3.0 mm

Cuir véritable de Russie | « Art Manuel » |
Couture : points de couture assortis | Épaisseur du bracelet :
environ 6,0 mm à 3,0 mm

MADE IN
GERMANY



Length Longueur (mm)		R
		114 82
Width Largeur		
Lug/Patte	Buckle/Boucle	
18 mm	16 mm	✓
20 mm	18 mm	✓
22 mm	18 mm	✓

Cross-section: | Coupe transversale :



» ROUND « | » ROND «



200 **1** 200 **2D** 200 **3** 200 **12**
black dark brown tan grey
Noir Marron Bronze Gris
foncé



Mod. R39 | Havana

Genuine Pigskin |
Seam: cream white | Thickness of strap: approx. 3.5 mm to 3.0 mm

Peau de porc véritable |
Couture : blanc crème | Épaisseur du bracelet : environ 3,5 mm
à 3,0 mm

MADE IN
GERMANY

Length Longueur (mm)		R
		114 82
Width Largeur		
Lug/Patte	Buckle/Boucle	
18 mm	16 mm	✓
20 mm	18 mm	✓
22 mm	18 mm	✓

Cross-section: | Coupe transversale :



» SQUARE « | » CARRÉ «



39 **1** 39 **2D** 39 **3**
black dark brown tan
Noir Marron Bronze
foncé



Mod. R207 | Performance

Genuine Buffalo Leather |
 Seam: cream white | matching stitching | Thickness of strap:
 approx. 7.5 mm to 4.5 mm
 Cuir de buffle véritable |
 Couture : blanc crème | points de couture assortis |
 Épaisseur du bracelet : environ 7,5 mm à 4,5 mm

MADE IN
GERMANY

Length Longueur (mm)		R
		114 82
Width Largeur		
Lug / Patte	Buckle / Boucle	
20 mm	20 mm	✓
22 mm	20 mm	✓
24 mm	20 mm	✓

Cross-section: | Coupe transversale :



» ROUND « | » ROND «



Mod. R61 | Nature

Genuine Buffalo Leather | »Saddler's Seam (Hand Seam)« |
 Seam: cream white | Thickness of strap: approx. 6.0 mm to 5.0 mm
 Cuir de buffle véritable | « Couture du sellier » (couture à la main) |
 Couture : blanc crème | Épaisseur du bracelet :
 environ 6,0 mm à 5,0 mm

MADE IN
GERMANY



Length Longueur (mm)		R
		114 82
Width Largeur		
Lug / Patte	Buckle / Boucle	
18 mm	18 mm	✓
20 mm	18 mm	✓
22 mm	18 mm	✓

Cross-section: | Coupe transversale :



» SQUARE « | » CARRÉ «





Mod. R198 | Chicago

Genuine Shell Cordovan Leather | »Art Manuel« | »Saddler's Seam (Hand Seam)« |

Seam: matching stitching | Thickness of strap: approx. 6.0 mm to 3.0 mm

Cuir véritable avec coquille de Cordoue | « Art Manuel » | « Couture de sellier (Couture à la main) » |

Couture : points de couture assortis | Épaisseur du bracelet : environ 6,0 mm à 3,0 mm

MADE IN GERMANY



Length Longueur (mm)		R
		114 82
Width Largeur		
Lug/Patte	Buckle/Boucle	
18 mm	16 mm	✓
19 mm	16 mm	✓
20 mm	18 mm	✓
22 mm	18 mm	✓

Cross-section: | Coupe transversale :



» ROUND « | » ROND «



198 **1** 198 **2D** 198 **3**
 black dark brown tan
 Noir Marron Bronze
 foncé



Mod. R199 | New York

Genuine Shell Cordovan Leather | »Art Manuel« | »Saddler's Seam (Hand Seam)« |

Seam: cream white | Thickness of strap: approx. 6.0 mm to 3.0 mm

Cuir véritable avec coquille de Cordoue | « Art Manuel » | « Couture de sellier (Couture à la main) » |

Couture : blanc crème | Épaisseur du bracelet : environ 6,0 mm à 3,0 mm

MADE IN GERMANY



Length Longueur (mm)		R
		114 82
Width Largeur		
Lug/Patte	Buckle/Boucle	
18 mm	16 mm	✓
19 mm	16 mm	✓
20 mm	18 mm	✓
22 mm	18 mm	✓

Cross-section: | Coupe transversale :



» ROUND « | » ROND «



199 **1** 199 **2D** 199 **3**
 black dark brown tan
 Noir Marron Bronze
 foncé



Mod. R133 | Just

Hightech Material Nytech | »Water resistant« | »Art Manuel« |
Seam: matching stitching | Thickness of strap: approx. 7.0 mm to 3.0 mm

Matériel Hightech Nytech | « Résistant à l'eau » | « Art Manuel »
Couture : points de couture assortis | Épaisseur du bracelet :
environ 7,0 mm à 3,0 mm

MADE IN
GERMANY

Length Longueur (mm)		R
		114 82
Width Largeur		
Lug / Patte	Buckle / Boucle	
18 mm	16 mm	✓
20 mm	18 mm	✓
22 mm	20 mm	✓
24 mm	22 mm	✓

Cross-section: | Coupe transversale :



» ROUND « | » ROND «



133 **1**
black
Noir



Mod. R131 | Next

Hightech Material Ballistic | »Water resistant« | »Art Manuel« |
Seam: cream white | Thickness of strap: approx. 6.0 mm to 3.0 mm

Matériel high-tech balistique | « Résistant à l'eau » |
« Art Manuel » |
Couture : blanc crème | Épaisseur du bracelet :
environ 6,0 mm à 3,0 mm

MADE IN
GERMANY



Length Longueur (mm)		R
		114 82
Width Largeur		
Lug / Patte	Buckle / Boucle	
18 mm	16 mm	✓
20 mm	18 mm	✓
22 mm	18 mm	✓

Cross-section: | Coupe transversale :



» ROUND « | » ROND «



131 **1**
black
Noir



Mod. R205 | Kaluga

Genuine Russia Leather with racing holes | »Art Manuel« |
Seam: cream white | Thickness of strap: approx. 6.0 mm to 3.0 mm

Cuir véritable de Russie avec trous de passage | « Art Manuel » |
Couture : blanc crème | Épaisseur du bracelet : environ
6,0 mm à 3,0 mm

MADE IN
GERMANY



Length Longueur (mm)		R
		114 82
Width Largeur		
Lug/Patte	Buckle/Boucle	
18 mm	16 mm	✓
20 mm	18 mm	✓

Cross-section: | Coupe transversale :



» ROUND « | » ROND «



205 1
black
Noir

205 2D
dark brown
Marron
foncé

205 3
tan
Bronze



Mod. R390 | Engineer

Genuine Russia Leather | For folding buckle | »Art Manuel« |
Seam: cream white or orange | Thickness of strap:
approx. 5.5 mm to 2.0 mm

Cuir véritable de Russie | pour boucle rabattable |
»Art Manuel« |

Couture : blanc crème ou orange | Épaisseur du
bracelet : environ 5,5 mm à 2,0 mm

MADE IN
GERMANY



Length Longueur (mm)		M
		104 100
Width Largeur		
Lug/Patte	Buckle/Boucle	
19 mm	16 mm	✓
20 mm	18 mm	✓
22 mm	18 mm	✓

Cross-section: | Coupe transversale :



» ROUND « | » ROND «



390 1/0
black
Noir

390 1/13
orange
Orange

– Technical specification –
RIOS1931 watch strap, particularly suitable
for watches of the brand »Omega«

– Spécification technique –
RIOS1931 Bracelet de montre,
particulièrement adapté aux
montres de marque « Omega »



Mod. R408 | Waging

Genuine Certified Organic Leather |
Seam: matching stitching | Thickness of strap: approx. 3.5 mm to 3.5 mm

Cuir véritable certifié biologique |
Couture : points de couture assortis | Épaisseur du bracelet :
environ 3,5 mm à 3,5 mm

M A D E I N
G E R M A N Y

Length Longueur (mm)		R
		114 82
Width Largeur		
Lug / Patte	Buckle / Boucle	
18 mm	16 mm	✓
20 mm	18 mm	✓

Cross-section: | Coupe transversale :



» SQUARE « | » CARRÉ «



408 1

black
Noir

408 2D

dark brown
Marron
foncé

408 3

tan
Bronze



RIOS1931 | Saddle's Seam |

It takes a master craftsman about 40 minutes to complete a perfectly stitched saddle's seam (hand seam) that will last and last.

RIOS1931 | Couture du Sellier |

Un maître artisan met environ 40 minutes pour réaliser une couture de sellier (couture à la main) parfaitement cousue, qui durera longtemps.



RIOS1931 | Water resistant |

Water resistance achieved by high-tech materials or a hydro-finished upper leather, intermediate layer and leather lining.

RIOS1931 | Couture du Sellier |

Résistance à l'eau obtenue grâce à des matériaux de haute technologie ou à un cuir hydrofini sur la partie supérieure avec une couche intermédiaire et une doublure en cuir.



RIOS1931 | Art Manuel |

The high-end »Art Manuel« strap is hand finished similarly to a »Goodyear welted« or »frame-stitched« shoe. The finest of traditional craftsmanship.

RIOS1931 | Art Manuel |

Le bracelet haut de gamme » Art Manuel « est fini à la main de la même manière qu'une » semelle Goodyear « ou une chaussure » cousue ». Le meilleur de l'artisanat traditionnel.



RIOS1931 | Organically Tanned Leather |

Upper and lining leather is tanned with vegetable substances processed according to traditional formulas with extracts of groundwood, bark, leaves and fruits. The extraordinary softness and pleasant touch result from the use of natural fats and waxes. The vegetable tanning substances give the watch strap a typical leather fragrance of bees wax and tobacco.

RIOS1931 | Cuir tanné de manière organique |

Le cuir de la partie supérieure et de la doublure est tanné avec des substances végétales traitées selon des formules traditionnelles avec des extraits de bois de terre, d'écorce, de feuilles et de fruits broyés. L'extraordinaire douceur et le toucher agréable proviennent de l'utilisation de graisses et de cires naturelles. Les substances végétales utilisées pour le tannage confèrent au bracelet de la montre un parfum typique de cire d'abeille et de tabac.



RIOS1931 | Organic Watch Straps |

All steps within the production chain are ecologically sustainable and certified organic. The natural and vegetable-tanned, absolutely soft leather give the straps of this series an excellent feel and high wearing comfort.

Chromium-free • Natural & vegetable-tanned leather • Allergy-friendly • Animal welfare approved • Sustainability chain • Leather from German cattle from approved organic farms • «Biokreis», ECARF + IVN certified

RIOS1931 | Bracelets de montre organiques |

Toutes les étapes de la chaîne de production sont écologiquement durables et certifiées biologiques. Le cuir naturel qui est tanné végétalement et d'une douceur absolue, confère aux bracelets de cette série une excellente sensation au toucher et un grand confort de port.

Sans chrome - Cuir naturel et tanné végétalement - Adapté aux allergies - Approuvé pour le bien-être des animaux - Chaîne de durabilité - Cuir provenant de bovins allemands issus d'exploitations biologiques agréées - Certifié « Biokreis », ECARF + IVN



|Mod. R1221| Talent

Display Box

Synthetic leather with 5 trays for a total of 52 watch straps | 4 trays each for 11 watch straps | 1 tray for 8 watch straps

(Photo similar to original object, pictured contents not included)

Length: approx. 345 mm, width: approx. 100 mm, height: approx. 130 mm

Boîte de rangement

Cuir synthétique à cinq plateaux pour 52 bracelets de montre au total | 4 plateaux pour 11 bracelets de montre chacun | 1 plateau pour 8 bracelets de montre

(Photo identique à l'objet original, contenu de la photo non inclus)

Longueur : environ 345 mm, largeur : environ 100 mm, hauteur : environ 130 mm



|Mod. R1988| Chet

Rotating Display Box

Lockable rotating display with storage drawers | holds 144 bands

(Photo similar to original object, pictured contents not included)

Length: approx. 370 mm, width: approx. 230 mm, height: approx. 355 mm

Boîte de Présentation Rotative

Boîte de présentation rotative verrouillable avec tiroirs de rangement | pouvant contenir 144 bracelets

(Photo identique à l'objet original, contenu de la photo non inclus)

Longueur : environ 370 mm, largeur : environ 230 mm, hauteur : environ 355 mm



|Mod. R1210| Genius

Presentation Folder

(without cards)

2 pages holding 8 cards for a total approx.
80 watch straps

(Photo similar to original object, pictured contents not included)

Closed - length: approx. 270 mm, width: approx. 170 mm, height:
approx. 100 mm

Open - length: approx. 270 mm, width: approx. 850 mm, height: approx. 30 mm

Carnet de présentation (sans cartes)

2 pages contenant 8 cartes pour un total d'environ 80 bracelets de montre

(Photo identique à l'objet original, contenu de la photo non inclus)

Fermé - longueur : environ 270 mm, largeur : environ 170 mm, hauteur : environ 100 mm
Ouvert - longueur : environ 270 mm, largeur : environ 850 mm, hauteur : environ 30 mm.



|Mod. R1200|

Inserting Cards

In different varieties, lengths and widths.

(Photo similar to original object)

Length: approx. 250 mm, width: approx. 150 mm,
height: approx. 5 mm

Cartes d'insertion de cartes

Variétés différentes, en longueur et en largeur.

(Photo similaire à l'objet original)

Longueur : environ 250 mm, largeur : environ 150 mm,
hauteur : environ 5 mm



10400 Strap Folder
With 4 Removable Trays.
7 1/2 x 3 x 12 1/2



Removable Trays
available in 4 different
sizes 12, 16, 20, 24 to
hold 6-24 mm watch
bands



10422-1
Men's Large Size Strap Folder
holds 22 & 24mm watch bands
Capacity: 40 pcs.
7 1/2 x 3 x 12 1/2



101820
Strap Folder with 4 Stackable Trays
Holds up to 20mm watch bands
Capacity: 72 pcs.
13 x 9 1/2 x 4



Tray C Stackable Silicone Band Tray
Capacity: 9 pcs.
16¼ x 7 x 2½



5020 Strap Folder
Capacity: 20 pcs.
6 x ¾ x 10



Tray A Stackable Metal Band Tray
Capacity: 9 pcs.
12½ x 8¼ x ¾



Tray B Stackable Metal Band Tray
Capacity: 7 pcs.
12½ x 8¼ x ¾



ALP264
Rotating Display
Stand sold separately
Capacity: 264 pcs.
14 x 14 x 14 [display]
38 x 14 x 14 [stand]

Genuine Leather Band Collection / Collection de bracelets de cuir véritable



469 Smooth Leather with Silicone Lining black/dark brown
Size: 22mm 80 x 120mm



455 Smooth Leather with Silicone Lining black/brown/tan
Sizes: 20, 22mm 80 x 120mm

368 Alligator Grain Leather with Silicone Lining black/black, black/red, black/blue, black/yellow, black/orange, brown/black
Sizes: 20, 22, 24mm 80 x 120mm

Genuine Leather Band Collection / Collection de bracelets de cuir véritable



412 Flat Stitched Leather
black/brown/red/pink/blue/burgundy/grey/orange/white/beige/
green/light brown

Sizes: 12, 14mm 70 x 110mm
16, 18, 20, 22mm 75 x 120mm



421 CORDURA® Fabric with Water Resistant Leather
black/olive/khaki/grey/navy/red/orange
Sizes: 14, 16mm 75 x 115mm
18, 20, 22mm 80 x 120mm



Genuine Leather Band Collection / Collection de bracelets de cuir véritable



302 Vintage Leather
black/brown/light brown
Sizes: 18, 20, 22mm 80 x 120mm



465 Thick Plain Leather
black/brown/light brown/
Sizes: 20, 22mm 80 x 120mm



360 Padded Waterproof Leather
black/brown/light brown
Sizes: 18, 20, 22, 24mm 75 x 115mm

Waterproof Leather



395 Padded Stitched Italian Leather black/brown
Sizes: 18, 20, 22, 24mm 75 x 115mm
Sizes: 18L, 20L, 22L, 24L 85 x 125mm



390 Hand Painted Leather
black/brown/beige
Sizes: 18, 20, 22, 24mm 80 x 120mm



340 Vintage Leather
black/brown/light brown
Sizes: 20, 22, 24mm 80 x 120mm

Genuine Leather Band Collection / Collection de bracelets de cuir véritable



310 Soft Thin Perforated Leather
black/brown/mud brown/beige
Sizes: 20, 22mm 75 x 115mm



320 Genuine Suede Leather
black/brown/military green/beige/light brown
Sizes: 20, 22, 24mm 75 x 115mm



461 Vegan Watch Band
black/brown/tan/pink
Sizes: 12, 18, 20mm 80 x 120mm



475 Padded Stitched Leather
dark gray/beige/blue/green/pink/peach
Sizes: 22, 24mm 75 x 115mm

Genuine Leather Band Collection / Collection de bracelets de cuir véritable



339 Padded Stitched Croco Grain Leather black/brown/red/blue
 Sizes: 12, 14mm 70 x 105mm
 16, 18, 20mm 75 x 115mm



385 Stitched Alligator Grain Leather
 white/black/brown/blue/green/beige
 Sizes: 12, 14mm 70 x 105mm
 16, 18, 20mm 75 x 115mm



316 Padded Stitched Alligator Grain Leather black/brown/beige
 Sizes: 20, 22mm 75 x 115mm



416 Padded Stitched Alligator Grain Leather black/brown/tan
 Sizes: 17, 19, 21mm 75 x 115mm

317L Padded Stitched Croco Grain Leather black/brown
 Sizes: 10L, 12L, 14L 80 x 115mm
 16L 18L, 20L, 22L 85 x 125mm

Genuine Leather Band Collection / Collection de bracelets de cuir véritable



386 Padded Stitched Alligator Grain Leather
black/brown/red/pink/baby blue/green/
white/beige/burgundy/navy/grey
Sizes: 18, 20, 22, 24mm 75 x 115mm

Sizes: 20S 70 x 110mm (black/brown/white/red)

Sizes: 18L, 20L, 22L, 24L 85 x 125mm (black/brown/navy/white)

S = Short Band, L = Long Band



319 Padded Stitched Lizard Grain Leather
white/black/brown/red/pink/yellow



Sizes: 10, 12, 14mm 70 x 105mm
16, 18, 20, 22mm 75 x 115mm

Genuine Leather Band Collection / Collection de bracelets de cuir véritable



364 Sporty Padded Stitched black/brown
 Sizes: 18, 20, 22, 24mm 75 x 115mm
 black/white, black/red, black/blue, black/orange, brown/beige

Waterproof Leather



318 Flat Lizard Grain Leather
 black/blue/brown/pink/grey
 Sizes: 12, 14mm 70 x 105mm
 18mm 75 x 115mm



331 Smooth Padded Stitched Leather
 black/blue/brown/light brown/burgundy/green/white
 Sizes: 10, 12, 14mm 70 x 105mm
 16, 18, 20mm 75 x 115mm
 Size: 22mm 75 x 115mm (black, brown only)

Genuine Leather Band Collection / Collection de bracelets de cuir véritable



346 Flat Calf Leather
 black/blue/light brown/yellow/burgundy/green/purple/pink
 Sizes: 12, 14mm 70 x 105mm
 16, 18, 20mm 75 x 115mm



327 Flat Stitched Croco Grain Leather
 black/blue/brown/light brown/red
 Sizes: 12, 14mm 70 x 105mm
 16, 18mm 75 x 115mm
 Sizes: 12L, 14L 80 x 115mm (black/brown)
 16L, 18L 85 x 125mm (black/brown)



371 Padded Stitched Croco Grain Leather
 black/brown/white/orange
 Sizes: 12, 14mm 70 x 105mm
 16, 18, 20, 22, 24mm 75 x 115mm

Genuine Leather Band Collection / Collection de bracelets de cuir véritable



301 Louisiana Alligator Grain Leather black/brown/red/white
 Sizes: 6, 8, 10mm 70 x 105mm



433 Special Cut Leather to Fit Skagen® Watch black/brown
 Size: 20mm 80 x 120mm



308L Stitched Oil Leather black/brown
 Sizes: 18L, 20L, 22L, 24L 85 x 125mm



354 Padded Waterproof Leather black/brown
 Sizes: 14mm 70 x 105mm
 16, 18, 20, 22, 24mm 75 x 115mm
 Sizes: 18L, 20L, 22L 85 x 125mm

Waterproof Leather



392 Padded Heavy Stitched Calf Leather black/brown
 Sizes: 18, 20, 22mm 75 x 115mm



387 Stitched Alligator Grain Leather black/brown
 Sizes: 18, 20mm 75 x 115mm



350 Camel Grain Leather black/tan
 Sizes: 18, 20, 22, 24mm 75 x 115mm



434 Flat Stitched Lizard Grain Leather black/brown/tan
 Sizes: 15, 17, 19mm 75 x 115mm

Genuine Leather Band Collection / Collection de bracelets de cuir véritable



394 Padded Stitched Italian Leather black/brown/light brown
 Sizes: 12, 14mm 70 x 105mm
 16, 18, 20mm 75 x 115mm
 Sizes: 18L, 20L 85 x 125mm (black/brown)



406 Smooth Stitched Perforated Leather
 black/brown/tan
 Sizes: 18, 20, 22mm 75 x 115mm



429 Flat Stitched Crushed Leather black/brown/blue/red
 Sizes: 18, 20, 22mm 75 x 115mm



436 Padded Stitched Alligator Grain Leather
 black/brown/dark brown/blue
 Sizes: 10, 12, 14mm 68 x 108mm
 16, 18, 20, 22mm 75 x 118mm



407 Soft Smooth Flat Leather black/brown/blue/red
 Sizes: 12, 14mm 70 x 115mm
 18mm 75 x 118mm



Genuine Leather Band Collection / Collection de bracelets de cuir véritable



311 Flat Lizard Grain Leather black/brown
 Sizes: 8, 10, 12, 14mm 70 x 100mm
 16, 18, 20mm 75 x 115mm
 Sizes: 8L, 10L, 12L, 14L 75 x 115mm
 16L, 18L, 20L 85 x 125mm



332 Flat Stitched Leather black/brown
 Sizes: 10, 12, 14mm 70 x 100mm
 16, 18, 20mm 75 x 110mm
 Sizes: 10L, 12L, 14L 75 x 115mm
 16L, 18L, 20L 85 x 125mm



324 Soft Slim Waterproof Leather black/brown **Waterproof Leather**
 Sizes: 12, 14mm 70 x 105mm
 16, 18, 20, 22mm 75 x 115mm



334 Flat Stitched Leather black/brown/white
 Sizes: 10, 12, 14mm 70 x 105mm
 16, 18mm 75 x 115mm



343 Soft Thin Stitched Leather black/brown
 Sizes: 12, 14mm 70 x 105mm
 16, 18mm 75 x 115mm



305 Smooth Plain Leather black/grey/beige/pink
 Size: 22mm 80 x 120mm



315 Smooth Polished Leather black/brown
 Sizes: 12mm 70 x 105mm
 18, 20mm 75 x 115mm

Genuine Leather Band Collection / Collection de bracelets de cuir véritable



467 Genuine Crushed Leather
black/blue/dark brown/grey
Sizes: 10, 12, 14mm 70 x 110mm
16, 18, 20, 22mm 75 x 115mm



480 Eco Friendly Padded Vegan
blue/red/green/beige
Sizes: 12, 14mm 70 x 110mm
16, 18, 20mm 80 x 120mm



438 Padded Stitched Soft Leather
grey/burgundy/dark brown/blue/light brown/brown
Sizes: 18, 20, 22mm 80 x 120mm



413 Smooth Flat Leather
black/blue/pink/red/brown/white
Sizes: 12, 14mm 70 x 110mm
16, 17, 18, 19, 20, 22mm 80 x 115mm

Genuine Leather Band Collection / Collection de bracelets de cuir véritable



179B Fits Special Cut Gents Chrono Watch
black
Size: 179B Long 85 x 115mm



179 Fits Special Cut Gents Chrono Watch
White Stitching
black/blue/green/yellow/red
Size: Gents Chronograph 80 x 110mm



173 Fits Special Cut Gents Skin Watch
black 80 x 110mm



172 Fits Special Cut Gents Regular Watch
burgundy/brown
Sizes: Gents Regular 80 x 110mm



172L Long available in black only 90 x 120mm



149 Padded Stitched Leather Open End
black/brown
Sizes: 10, 12, 14, 16, 18, 20mm
back side of 149



147 Genuine Lizard Padded Stitched Open End
black
Sizes: 10, 12, 14, 16, 18, 20mm
Taper: 10x8, 12x10, 14x12, 16x14,
18x16, 20x18



back side of 147



314 Padded Stitched with Protective Flap under the Buckle
black
Sizes: 12mm 70 x 105mm

Genuine Leather Band Collection / Collection de bracelets de cuir véritable



313 Flat Thin Alligator Grain Leather black/brown
Sizes: 22, 24mm 75 x 115mm



383 Flat Thick Oil Leather black/brown
Sizes: 22, 24mm 80 x 120mm



336 Stitched Leather black/brown
Sizes: 26, 28, 30mm 75 x 115mm



325 Stitched Leather black/brown
Sizes: 32, 34mm 75 x 115mm

328 Stitched Alligator Grain Leather black/brown/blue/red/white
Sizes: 26, 28, 30mm 75 x 115mm

Genuine Leather Band Collection / Collection de bracelets de cuir véritable



375 Heavy Flat Stitched Buffalo Grain Leather
black/brown
Sizes: 22, 24, 26mm 80 x 120mm



431 Smooth Padded Stitched Leather black/brown
Sizes: 26, 28mm 75 x 115mm



351 Flat Stitched Alligator Grain Leather
black/brown
Sizes: 22, 24mm 80 x 120mm



373 Thick Stitched Leather
black/brown
Sizes: 22, 24, 26mm 80 x 120mm



449 Horween® Thick Leather
black/brown
Sizes: 20, 22mm 80 x 120mm



341 Soft Stitched Leather
black/brown
Sizes: 22, 24mm 80 x 120mm

Watch Bands Compatible with Apple Watches / Bracelets de montre compatibles avec les montres Apple



L500 & L600 Leather

Model	Width	Size
L500 - Fits models 38, 40, 41mm	32mm	75 x 113
L600 - Fits models 42, 44, 45, 49mm & Ultra	34.5mm	75 x 113

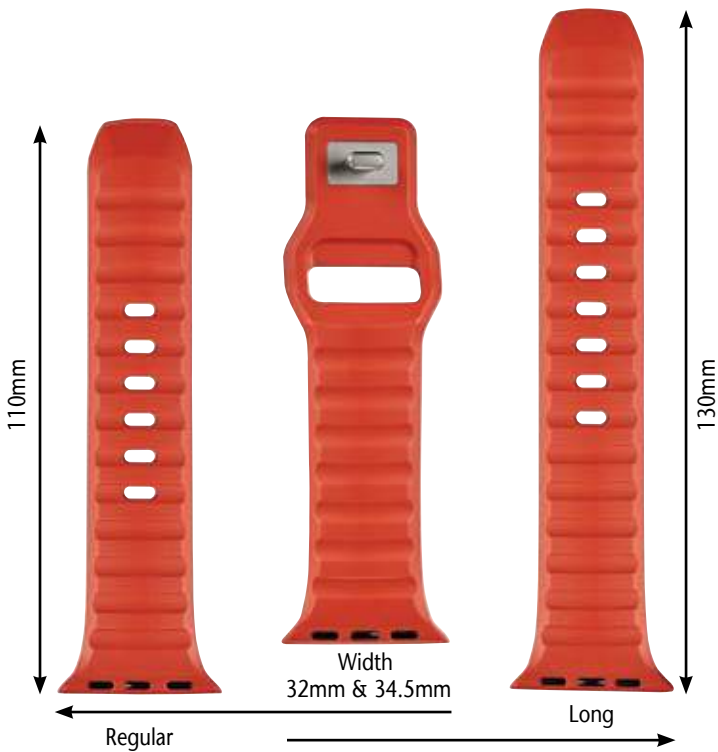

S50 & S60 Silicone
black/blue/orange/green/pink/beige

Model	Width	Regular Length	Long Length
S50 - Fits models 38, 40, 41mm	32mm	85 x 110	85 x 130
S60 - Fits models 42, 44, 45, 49mm & Ultra	34.5mm	85 x 110	85 x 130

Genuine Leather Band Collection / Collection de bracelets de cuir véritable



300 Vintage Leather Cuff Band black/brown/tan
 Sizes: 20, 22, 24mm 80 x 120mm



199 Flat Thick Leather Cuff Band black/brown (black 20, 24mm only)
 Sizes: 20, 22, 24mm 75 x 130mm



384 Padded Stitched Alligator Grain Leather black/brown
 Sizes: 18XL, 20XL, 22XL, 24XL, 26XL 95 x 135mm



Extra Long Band



379 Padded Stitched Buffalo Grain Leather black/brown/light brown
 Sizes: 18XL, 20XL, 22XL, 24XL, 26XL 95 x 135mm

Extra Long Band

Silicone Sports Band Collection / Collection de bracelets de montres en Silicone



S3800 Silicone
black/grey/green/orange/red/beige/pink
Sizes: 22mm



S3400 Silicone
black/blue/green/beige/grey
Sizes: 22L, 24L 75 x 130mm



LOOP Silicone Band Loop
Size: 20, 22mm



Silicone/Rubber
Band Packaging

Nylon Bracelets / Bracelets Nylon



V1016.08 black-green 16mm



V1016.01 black-black 16mm



V1016.11 black-yellow 16mm



N91 Nylon brown
Sizes: 18L, 20L (long)



N91 Nylon black
Sizes: 18, 18L, 20, 20L (reg. & long)



N91 Nylon olive
Sizes: 18L, 20L



N91 Nylon blue
Sizes: 18L, 20L



V20201 black-black 20mm



V1020.08 black-green 20mm

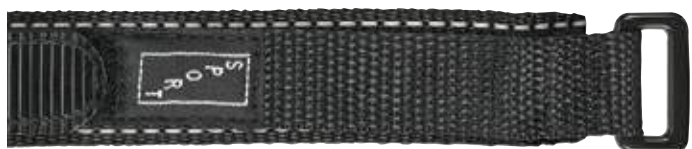

V1020.01 black-black 20mm



V1025.04 black-red 20, 22mm



V1025.07 black-blue 20, 22mm



V1025.01 black-black 20, 22mm



V1013.01 orange-black 20, 22mm



V20207 black-blue 20mm

Silicone Sports Band Collection / Collection de bracelets de montres en Silicone



S1600 Size: 18, 20, 22, 24mm 70 x 120mm Silicone
black/blue/red



S2600 Sizes: 18, 20, 22mm 75 x 120mm Silicone



S3100 Sizes: 18, 20, 22, 24mm 75 x 120mm Silicone



S2700 Sizes: 26, 28, 30mm 80 x 120mm Silicone
black/white/grey/blue/orange/red

S2500 Sizes: 18, 20, 22, 24mm 75 x 120mm Silicone



S2900 Sizes: 20, 22mm 80 x 115mm Silicone

S1700 Sizes: 26, 28mm 75 x 125mm Silicone

Silicone Sports Band Collection / Collection de bracelets de montres en Silicone

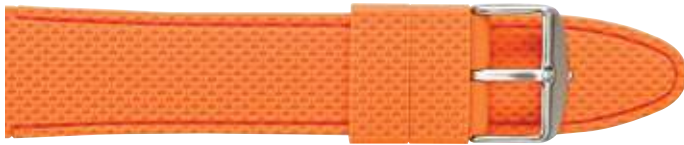

S1900 Sizes: 20, 22, 24mm 85 x 120mm Silicone
black/orange/white



S1800 Sizes: 18, 20, 22, 24mm 75 x 125mm Silicone
black/grey/white/red



S3200 Sizes: 20, 22, 24mm 80 x 120mm Silicone
black/blue, black/red, black/orange, black/black, black/grey



S1500 Sizes: 18, 20, 22, 24, 26mm 75 x 120mm Silicone
black/blue/orange/white/red

PVC/PU/Silicone Bands / Bracelets PVC/PU/Silicone



P1004-14mm P1004-18mm Sizes: 14, 18mm 70 x 120mm PU



P1008-22mm Size: 22mm 80 x 130mm PU



P1007-20mm Size: 20mm 80 x 135mm PU



P1022-22mm Size: 22mm 70 x 120mm PU



S3300 Black/white/grey/red/blue Silicone
 Sizes: 20mm 75 x 115mm
 22, 24mm 75 x 120mm



P1006-18mm Black 85 x 140mm PU
 P1006-22mm Black/red/blue 85 x 140mm PU



S1300 Sizes: 20, 22mm black Silicone



S1400 Black/pink/blue/white/red Silicone
 Sizes: 12mm 65 x 110mm
 14, 16mm 70 x 115mm
 18mm 75 x 120mm



S1300 Sizes: 20, 22mm blue Silicone

Silicone Sports Band Collection / Collection de bracelets de montres en Silicone



S2800 Sizes: 20, 22, 24, 26mm 80 x 120mm Silicone
black/red, black/yellow, black/blue, black/grey, blue/red

S2800 Sizes: 20, 22, 24, 26mm 80 x 120mm Silicone
yellow/orange/white/red/grey/navy/black/blue/green



S1327 Sizes: 20, 22, 24mm black/red/blue/orange Silicone

S1327 Sizes: 20, 22, 24mm black/red/blue/orange Silicone

Military Style Watch Bands Collection / Collection de bracelets de montres de style Militaire



N96-1 [4]

N96-1

N96-1 [13]

N96-7 [8]

N96 Nylon Band – Length 10 1/2”
 Sizes: 18, 20, 22, 24mm 260mm

N96-4 [7]

N45-7

N45 Nylon Band – Length 11”
 Sizes: 18, 20, 22mm 285mm

N45-1

N45-12

N45-15

N45-8

197 Genuine Calf Skin
 Sizes: 20, 22mm 255mm black/brown

Specialty Rubber Watch Bands & Accessories / Bracelets en caoutchouc et accessoires de montres spécialisés

Fits Omega® Watch



OM11 Sizes: 20,22mm black



OM13 Sizes: 20,22mm black

Fits Rolex® Watch



RO17 Sizes: 20mm blue



RO11 Sizes: 20mm black

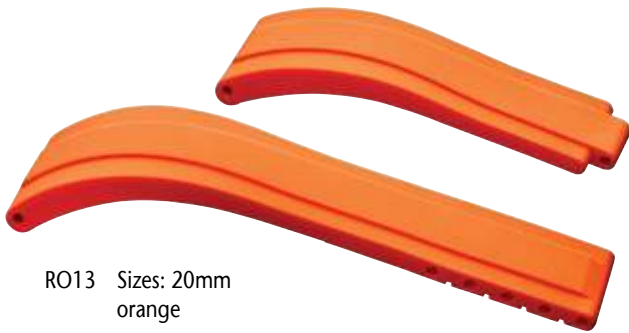

RO13 Sizes: 20mm orange



RO12 Sizes: 20mm black

Adapters to fit Apple® Watch

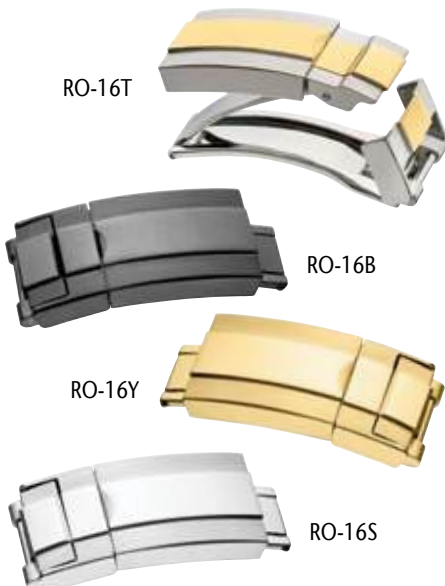

A38: fits watches size 38mm,40mm, 41mm

A42: fits watches size 42mm, 44mm, 45mm, 49mm



Buckles & Accessories / Fermoirs & accessoires



7890 Stainless Steel Deployment Buckles for Leather Bands
 Sizes: 16, 18, 20, 22mm
 Color: Silver & Yellow

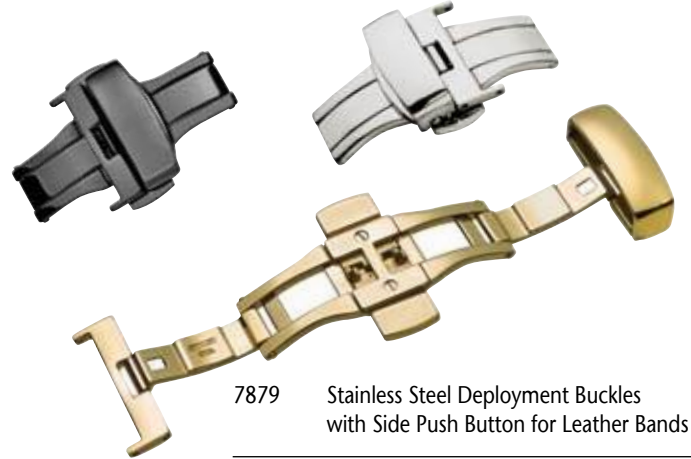

7879 Stainless Steel Deployment Buckles with Side Push Button for Leather Bands
 Sizes: 12, 14, 16, 18, 20, 22mm
 Color: Black, Silver & Yellow



HD-1622 Heavy Duty Stainless Steel Buckle
 Sizes: 16, 18, 20, 22, 24, 26mm
 (Also available in an assortment)
 Color: Silver, Rose Gold, Yellow & Black PVD Coated



LB-1622 Stainless Steel Leather Band Buckle
 Sizes: 16, 18, 20, 22mm
 (Also available in an assortment)
 Color: Silver, Rose Gold, Yellow & Black PVD Coated



00116 Stainless Steel 3 Fold Buckle
 Sizes: 10, 12, 14, 16, 18, 20mm
 Color: Silver



00212Y Stainless Steel Diver Buckle
 Sizes: 18, 20mm
 Color: Yellow



AB-1600 Aluminum Buckle
 Sizes: 16, 18, 20, 22mm
 Color: Silver, Rose Gold, Yellow & Black PVD Coated



00416B Stainless Steel Black PVD Coated Spring Buckle
 Sizes: 16, 18, 20, 22mm



00212 Stainless Steel Diver Buckle
 Sizes: 12, 14, 16, 18, 20mm
 Color: Silver



00522 Stainless Steel Driver Buckle with Button Release
 Sizes: 22, 24mm
 Color: Silver



00416 Stainless Steel Spring Buckle
 Sizes: 10, 12, 14, 16, 18, 20, 22, 24mm
 Color: Yellow & Silver



00212B Stainless Steel Black PVD Coated Divider Buckle
 Sizes: 18, 20mm

Buckles & Accessories / Fermoirs & accessoires



SB1.5-400
400 pieces spring bars
assortment - 1.5mm



SB1.5-1500
1500 pieces spring bars
assortment - 1.5mm

Loose spring bars are available in a pack of 50 pieces in 1.3 / 1.5 / 1.8mm diameter. Material: stainless steel, double flange



SB1.5-360
360 pieces spring bar
assortment - 1.5mm



Check our website for full selection of butterfly buckles



ALPINE INTERNATIONAL
21 PCS LEATHER BAND BUCKLE ASSORTMENT

Order No.: 818
Color: Silver

ASSORTMENT CONTAINS 3 OF EACH
6, 8, 10, 12, 14, 16 & 18mm WHITE BUCKLES



ALPINE INTERNATIONAL
STAINLESS STEEL BUCKLE ASSORTMENT

Order No.: 1622S
Color: Silver

ASSORTMENT INCLUDES 2 PCS EACH
IN SIZES 16, 18, 20 & 22mm



ALPINE INTERNATIONAL
STAINLESS STEEL BUCKLE ASSORTMENT

Order No.: 1622Y
Color: Yellow Ion Plated

ASSORTMENT INCLUDES 2 PCS EACH
IN SIZES 16, 18, 20 & 22mm



ALPINE INTERNATIONAL
STAINLESS STEEL BUCKLE ASSORTMENT

Order No.: 1622B
Color: Black PVD Coated

ASSORTMENT INCLUDES 2 PCS EACH
IN SIZES 16, 18, 20 & 22mm



ALPINE INTERNATIONAL
HEAVY DUTY STEEL BUCKLE ASSORTMENT

Order No.: HD1622
Colors: Black, Rose Gold, Silver, Yellow

ASSORTMENT INCLUDES 2 PIECES OF EACH
COLOR & SIZES 16, 18, 20 & 22mm



ALPINE INTERNATIONAL
STAINLESS STEEL BUCKLE ASSORTMENT

Order No.: 1622RG
Color: Rolled Gold Plated

ASSORTMENT INCLUDES 2 PCS EACH
IN SIZES 16, 18, 20 & 22mm



ALPINE INTERNATIONAL
RIVET PIN ASSORTMENT

Order No.: 1420
FOR DIVER BUCKLE SAFETY LOCK

ASSORTMENT INCLUDES 14 TO 20mm RIVET PINS

1420 Regular Size Rivet Pin Assortment
1421 Thick Size Rivet Pin Assortment

Ladies' Bracelets / Bracelets pour dames



B440Y (with yellow Buckle)



B440S (with silver Buckle)



Y440



S440



T406 — 8mm Straight End

Solid Link



Y406 — 8mm Straight End

Solid Link



Y407 — 7mm Lug End



T402 — 12mm Straight End



Y402 — 12mm Straight End



S403 — 12mm Straight End

Solid Link



S414 — 12 - 15mm Squeeze End

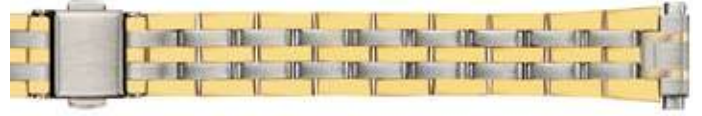

T414 — 12 - 15mm Squeeze End



B414 — 12 - 15mm Squeeze End



Y414 — 12 - 15mm Squeeze End



S401 — 10mm Straight End

Solid Link



T417 — 14 - 16mm Squeeze End



S417 — 14 - 16mm Squeeze End



B417 — 14 - 16mm Squeeze End



RG417 — 14 - 16mm Squeeze End



Y417 — 14 - 16mm Squeeze End



Ladies' Bracelets / Bracelets pour dames



B410 — 12, 14mm Straight End



RG410 — 12, 14mm Straight End



S410 — 12, 14mm Straight End



Y410 — 12, 14mm Straight End



T482 — 13 & 14mm Curved Ends Included



Y482 — 13 & 14mm Curved Ends Included



S482 — 13 & 14mm Curved Ends Included



S492 — 12mm Straight End

Solid Link



S404 — 14mm Straight End



Y423 — 14mm Straight End

Ladies' Expansion Bracelets / Bracelets extensibles pour dames



S3406 — 8 - 10mm Squeeze End



Y3406 — 8 - 10mm Squeeze End



T3406 — 8 - 10mm Squeeze End



Y2306 — 8 - 10mm Squeeze End



Long Band



S2306 — 8 - 10mm Squeeze End



Long Band



T2306 — 8 - 10mm Squeeze End



Long Band



Y2406 — 8 - 10mm Squeeze End



S2406 — 8 - 10mm Squeeze End



Y3006 — 8 - 10mm Squeeze End



S3006 — 8 - 10mm Squeeze End



T3006 — 8 - 10mm Squeeze End



Y4306 — 6mm Straight End

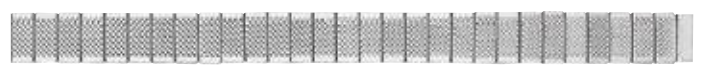

S4306 — 6mm Straight End

Ladies' Expansion Bracelets / Bracelets extensibles pour dames



T4306 — 6mm Straight End



Y2606 — Ring End



Y3309 — 10 - 14mm Squeeze End



S2606 — Ring End



S3309 — 10 - 14mm Squeeze End



T2606 — Ring End



T3309 — 10 - 14mm Squeeze End

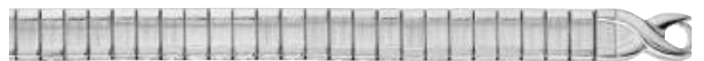

S2806 — Ring End



Y2909 — 10 - 14mm Curved Squeeze End



Long Band



Y2806 — Ring End



S2909 — 10 - 14mm Curved Squeeze End



Long Band



Y4309 — 10 - 14mm Squeeze End



T3309C — 10 - 14mm Curved Squeeze End



S4309 — 10 - 14mm Squeeze End



Y3309C — 10 - 14mm Curved Squeeze End



S4310 — 12mm Straight End



S3309C — 10 - 14mm Curved Squeeze End



S3509 — 10 - 14mm Squeeze End



Y2509 — 10 - 14mm Squeeze End



Y3509 — 10 - 14mm Squeeze End



T3509 — 10 - 14mm Squeeze End



Ladies' Expansion Bracelets / Bracelets extensibles pour dames



T2311 — 10 - 14mm Squeeze End



S4510 — 10 - 14mm Squeeze End



Y2311 — 10 - 14mm Squeeze End



T4510 — 10 - 14mm Squeeze End



S2311 — 10 - 14mm Squeeze End



Y4510 — 10 - 14mm Squeeze End



Y3611 — 10 - 14mm Squeeze End



Y2413 — 12 - 15mm Squeeze End

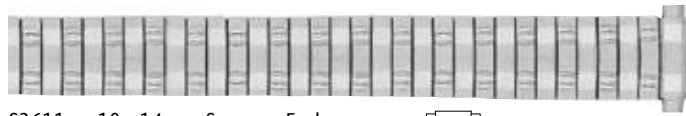

S3611 — 10 - 14mm Squeeze End



S2413 — 12 - 15mm Squeeze End



T3611 — 10 - 14mm Squeeze End



T2413 — 12 - 15mm Squeeze End



Y2709 — 10 - 14mm Curved Squeeze End



B2413 — 12 - 15mm Squeeze End



S2709 — 10 - 14mm Curved Squeeze End



T2709 — 10 - 14mm Curved Squeeze End



Men's Expansion Bracelets / Bracelets extensibles pour hommes



Y1715 — 16 - 22mm Squeeze End



S1715 — 16 - 22mm Squeeze End



Men's Expansion Bracelets / Bracelets extensibles pour hommes



Y1417 — 16 - 22mm Squeeze End



Y3915 — 16 - 22mm Squeeze End

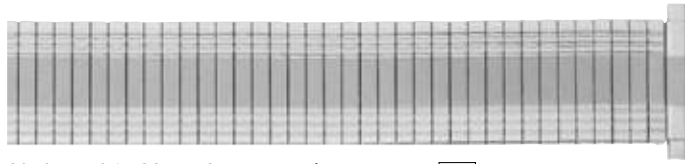

S1417 — 16 - 22mm Squeeze End

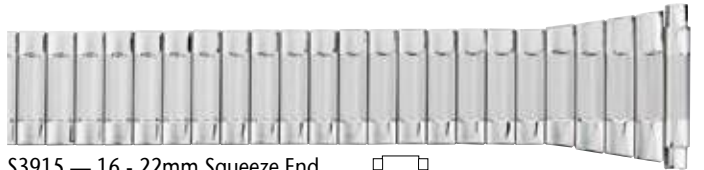

S3915 — 16 - 22mm Squeeze End

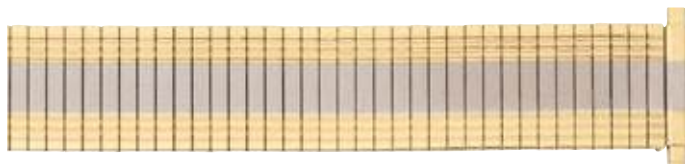

T1417 — 16 - 22mm Squeeze End

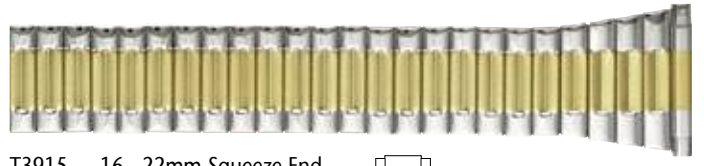

T3915 — 16 - 22mm Squeeze End



Y3818 — 18 - 22mm Curved Squeeze End



Y1617 — 16 - 22mm Squeeze End



S3818 — 18 - 22mm Curved Squeeze End



S1617 — 16 - 22mm Squeeze End



T3818 — 18 - 22mm Curved Squeeze End



Y1517 — 16 - 22mm Squeeze End



B3818 — 18 - 22mm Curved Squeeze End



S1517 — 16 - 22mm Squeeze End



BS3818 — 18 - 22mm Curved Squeeze End



T1517 — 16 - 22mm Squeeze End



Men's Expansion Bracelets / Bracelets extensibles pour hommes



Y3518 — 16 - 22mm Squeeze End 



Y1218 — 18 - 22mm Curved Squeeze End 



S3518 — 16 - 22mm Squeeze End 

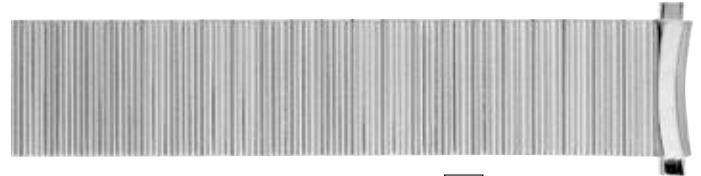

S1218 — 18 - 22mm Curved Squeeze End 



RG3518 — 16 - 22mm Squeeze End  Rose Gold Plated



Y1120 — 16 - 22mm Squeeze End 



T3518 — 16 - 22mm Squeeze End 



S1120 — 16 - 22mm Squeeze End 



T3824 — 24mm Straight End



T1120 — 16 - 22mm Squeeze End 



Y3824 — 24mm Straight End

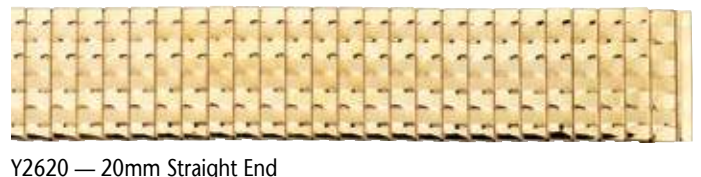

Y2620 — 20mm Straight End

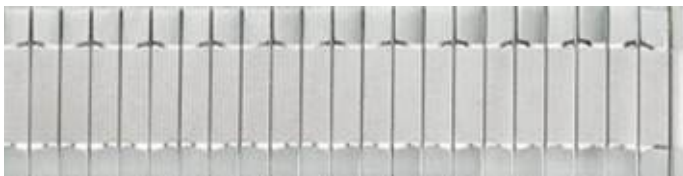

S3824 — 24mm Straight End

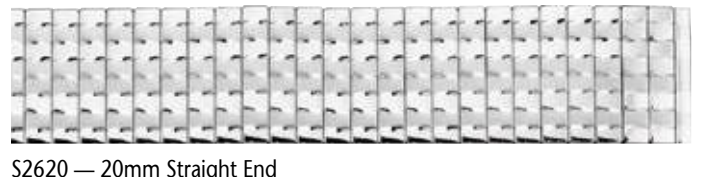

S2620 — 20mm Straight End

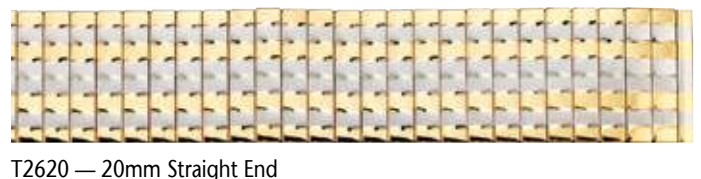

T2620 — 20mm Straight End

Men's Expansion Bracelets / Bracelets extensibles pour hommes



B3822 — 22mm Straight End



Y2918 — 16 - 22mm Squeeze End  **Long Band**



T3822 — 22mm Straight End

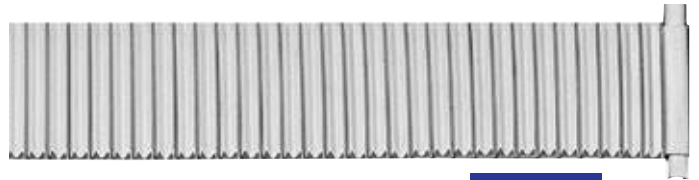

S2918 — 16 - 22mm Squeeze End  **Long Band**



Y3822 — 22mm Straight End



Y3122 — 22mm Straight End

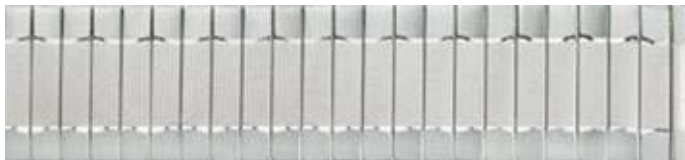

S3822 — 22mm Straight End



S3122 — 22mm Straight End

Links for Models
3518 and 1120



S3518-L



Y3518-L



S1120-L



T1120-L



Y1120-L



Y1715MED — 16 - 22mm Squeeze End 



S3122MED — 22mm Straight End



S3822MED — 22mm Straight End



Y3122MED — 22mm Straight End

Men's Bracelets / Bracelets pour hommes



Y510 — 16, 18, 20, 22mm Straight End



B510 — 16, 18, 20, 22mm Straight End

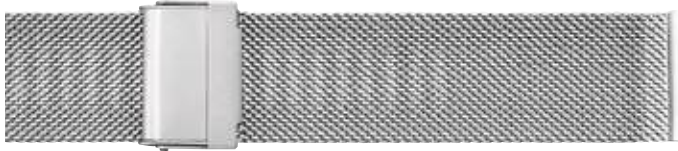

S510 — 16, 18, 20, 22mm Straight End



RG510 — 16, 18, 20, 22mm Straight End Rose Gold



Y518 — 18mm Straight End



B553 — 16 - 22mm Squeeze End



Y542 — 16 - 22mm Squeeze End



S553 — 16 - 22mm Squeeze End



S542 — 16 - 22mm Squeeze End



T553 — 16 - 22mm Squeeze End



T542 — 16 - 22mm Squeeze End



Y553 — 16 - 22mm Squeeze End

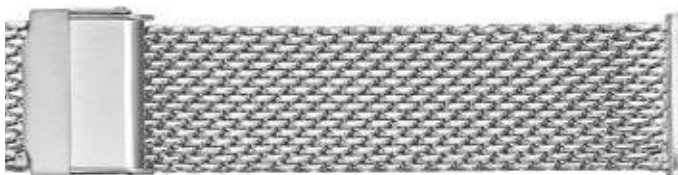

S530 — 22mm Straight End [Thick Mesh Band]

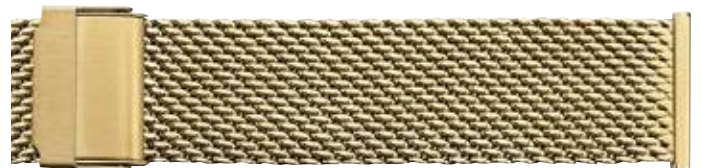

Y530 — 22mm Straight End [Thick Mesh Band]



B530 — 22mm Straight End [Thick Mesh Band]



RG530 — 22mm Straight End [Thick Mesh Band] Rose Gold

Men's Bracelets / Bracelets pour hommes



T594-1 — 16 - 22mm Squeeze End 



Y547 — 16-22mm Squeeze End 



S594-1 — 16 - 22mm Squeeze End 



S547 — 16-22mm Squeeze End 



Y548 — 20mm Straight End



T547 — 16-22mm Squeeze End 



S548 — 20mm Straight End

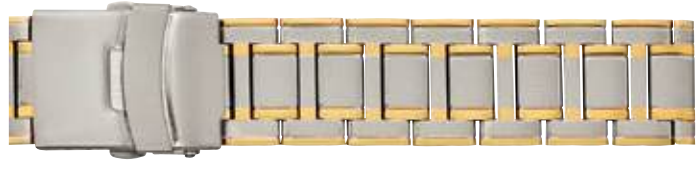

T539 — 20, 22mm Straight End



T548 — 20mm Straight End

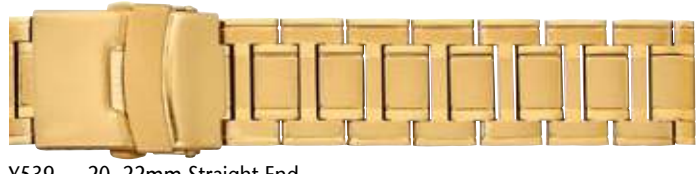

Y539 — 20, 22mm Straight End



B548 — 20mm Straight End



B539 — 20, 22mm Straight End



Y520 — 18mm Straight End



S539 — 20, 22mm Straight End



S520 — 18mm Straight End



T520 — 18mm Straight End

Men's Bracelets / Bracelets pour hommes



T527-22 — 22mm Straight End



B589 — 18, 20 & 22mm Curved End Included



Y535 — 18 & 20mm Curved End Included



S589 — 18, 20 & 22mm Curved End Included



S535 — 18 & 20mm Curved End Included



RG589 — 18, 20 & 22mm Curved End Included Rose Gold Plated



S594 — 18, 19 & 20mm Curved End Included



T589 — 18, 20 & 22mm Curved End Included



T526 — 20, 22 & 24mm Curved End Included



Y589 — 18, 20 & 22mm Curved End Included



B526 — 20, 22 & 24mm Curved End Included



Y582 — 18 & 20mm Curved End Included



S526 — 20, 22 & 24mm Curved End Included



S582 — 18 & 20mm Curved End Included



T582 — 18 & 20mm Curved End Included

Men's Bracelets / Bracelets pour hommes



Y575 — 16-22 Squeeze End



S566 — 26mm Straight End



S524 — 24mm Straight End



B566 — 26mm Straight End



T524 — 22, 24mm Straight End



T566 — 26mm Straight End



B524 — 24mm Straight End



Y566 — 26mm Straight End



Y537 — 20, 22, 24mm Straight End



Y523 — 20mm Straight End



B537 — 20, 22, 24mm Straight End

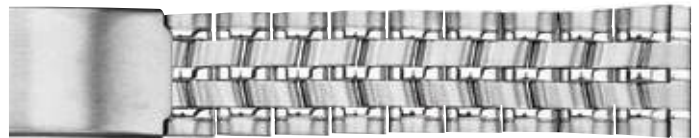

S523 — 20mm Straight End



S537 — 20, 22, 24mm Straight End



T523 — 20mm Straight End



B523 — 20mm Straight End

Men's Bracelets / Bracelets pour hommes



T599 — 18, 19 & 20mm Curved End w/buckle extender

Solid Link Bracelet

Set of 18, 19 and 20mm curved ends included



S599 — 18, 19 & 20mm Curved End w/buckle extender

Solid Link Bracelet



Y599 — 18, 19 & 20mm Curved End w/buckle extender



S596-20 — 20mm Solid Straight End
S596-22 — 22mm Solid Straight End
S596-24 — 24mm Solid Straight End

Solid Link Bracelet



S591-20 — 20mm Solid Straight End
S591-22 — 22mm Solid Straight End
S591-24 — 24mm Solid Straight End

Solid Link Bracelet



S605-22 — 22mm Solid Straight End
S605-24 — 24mm Solid Straight End
S605-26 — 26mm Solid Straight End

Solid Link Bracelet



T603-20 — 20mm Solid Straight End
T603-22 — 22mm Solid Straight End
T603-24 — 24mm Solid Straight End

Solid Link Bracelet

With side push butterfly buckle



S603-20 — 20mm Solid Straight End
S603-22 — 22mm Solid Straight End
S603-24 — 24mm Solid Straight End

Solid Link Bracelet
With side push butterfly buckle



B603-20 — 20mm Solid Straight End
B603-22 — 22mm Solid Straight End
B603-24 — 24mm Solid Straight End

Solid Link Bracelet

With side push butterfly buckle



B610-20 — 20mm Solid Straight End
B610-22 — 22mm Solid Straight End

Solid Link Bracelet



S593 — 22mm Straight End

Watch Tools and Batteries / Outils d'horloger et piles de montres



800
Renata Battery Tester



805
Battery Pulse
Tester



810
Renata Watch
Back Opener



815
Basic Watch Tool Kit



835
Screwdriver Assortment
on Rotating Stand



825
Economy Watch
Back Opener



Screw-360
360 pieces screw
assortment



830
2 Jaw Watch Case
Back Opener



845
Dust Blower

We carry watch
capacitors



maxell
Within the Future

Authorized distributor of
Maxell Watch Batteries



renata
batteries

Authorized distributor of
Renata Watch Batteries

Watch Tools and Batteries / Outils d'horloger et piles de montres



820
Bracelet Pin
Removing Tool



875
3 Jaw Back Opener
[Oversize Watch Case]

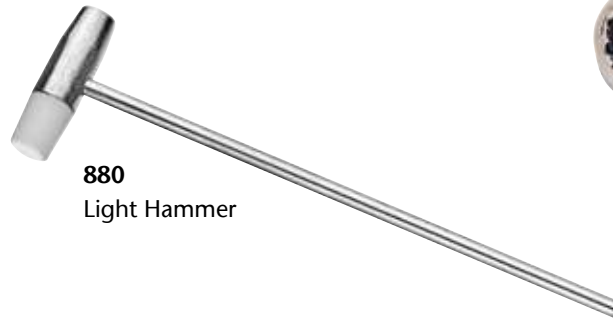

880
Light Hammer

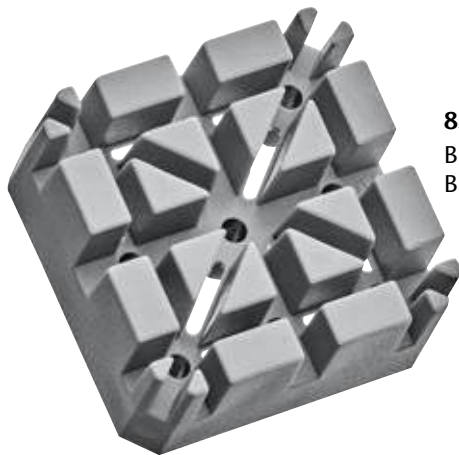

850
Bracelet
Block



855
2 Jaw Watch Case
Back Opener



860
Spring Bar Removing Tool - Long



865
Spring Bar Removing Tool - Short

870
Economical watch
Back Press



840
3-Piece Link Removing
Punch Pin Set [3 sizes]

Boxy Watch Winders Collection / Collection de remonte-montres Boxy



▲ **WOODEN HOUSING**
- Holds & winds 12 watch winders
PES-WH
16 3/4 x 5 1/2 x 15



◀ **SINGLE STACKABLE WATCH WINDER**
BWS-F
3 3/8 x 4 x 4 3/16



▶ **BATTERY PACK**
BP-01
5 1/2 x 2 3/4 x 1 1/2



◀ **EXTENDED POWER BAR PLATE**
- Holds and winds up to 12 Watch Winders with one AC adapter
(Watch winder sold separately)
PES-4
15 3/4 x 4 1/2 x 1



◀ **EXTENDED POWER BAR PLATE**
- Holds and winds up to 6 Watch Winders with one AC adapter
(Watch winder sold separately)
PES-2
7 3/4 x 4 1/2 x 1

▶ **BLDC WATCH WINDER FOR 2 WATCHES**
BLDC-B02
9 x 7 x 6

- 3 Year Warranty on BLDC Watch Winders



- Very quiet BLDC motor
- Touch Button for Interior Light
- USB Charging
- 3 Year Warranty

◀ **BLDC WATCH WINDER FOR 4 WATCHES**
BLDC-B04
9 x 7 x 11 1/2



Fancy Colourful Stackable Brick Winders /
Remontoirs Brick empilables colorés



WATCH WINDER
F-BWS-F-0
3 7/8 x 4 x 4 7/16



WATCH WINDER
F-BWS-F-13
3 7/8 x 4 x 4 7/16



WATCH WINDER
F-BWS-F-4
3 7/8 x 4 x 4 7/16



WATCH WINDER
F-BWS-F-1
3 7/8 x 4 x 4 7/16



Touch screen power activation
Deeper cavity, scratch-resistant watch cover
15-speed (TPD) setting

Alimentation électrique sur écran tactile
Cavité plus profonde, couvercle de montre
résistant aux rayures
Réglage (TPJ) 15 vitesses



◀ **WATCH BOX**
B40
3 x 3 ½ x 3 ½



◀ **LEATHERETTE CUFFLINKS DISPLAY**
- Holds 15 Pairs
CB15
7 x 4 x 2



WOODEN SUNGLASSES & JEWELLERY BOX ▲
DJ-106
13 ½ x 8 ¾ x 4 ½

▶ **LEATHERETTE JEWELLERY BOX**
JB-515
10 x 7 ½ x 4 ½





◀ **WATCH BOX**
B80
3 ¼ x 3 ¼ x 2 ¼



WATCH GIFT BOX ▲
- Holds 12 Watches
WD-1121
14 x 8 ¼ x 3



▲ LEATHERETTE WATCH BOX
- Holds 10 Watches
WB-310
11 ¼ x 9 x 4 ¾



WOODEN WATCH GIFT BOX ▲
- Holds 6 Watches
WD-906
14 x 4 ½ x 3



▲ WOODEN WATCH GIFT BOX WITH A DRAWER
- Holds 6 Watches and Jewellery
WJ-006
14 x 4 ½ x 5

Pocket Watch Collection / Collection de montre de poche



W3652
Mother of Pearl Dial /
Cadran en nacre blanche
Quartz / Quartz



W3759
Manual Wind /
Remontage manuel



W3417
Quartz / Quartz



W3762
Manual Wind /
Remontage manuel



W3368
Quartz / Quartz



W3363
Quartz / Quartz



W3654
Quartz / Quartz



W3372
Quartz / Quartz



W3392
Quartz / Quartz



W5321
Quartz / Quartz



Gift Box Included
(boîte cadeau comprise)



EC2823
5 1/2" x 1 3/4" x 7"



EC9900
6 1/2" x 2 5/8" x 8 1/2"



EC9904
5 1/4" x 1 3/4" x 6 1/4"



EC2207
6" x 6 1/2" x 2"



EC4501
4 3/4" x 1 7/8" x 6 1/4"



EC4901
4 1/2" x 5 1/2" x 3"



EC4902
6 1/2" x 3/4" x 4 1/2"



All clocks come with an engravable plate.
Les horloges peuvent toutes être personnalisées.

Medical ID Bracelets / Bracelets d'identification médicale [à graver]



BB816MED
Steel Magnetic
12mm



SB631MED
Steel
11mm



TB910MED
Titanium
16mm



TB810MED
Titanium
16mm



SB801MED
Steel
Black Onyx & CZ
12mm



BB1700MED-8.0
Steel
15mm



YB1700MED-7.5
YB1700MED-8.5
Steel
15mm
Available in 2 sizes.



SB1700MED-7.5
SB1700MED-8.5
Steel
15mm
Available in 2 sizes.

Length of all bracelets is approximately 8 to 8.5 inches
Longueur de tous les bracelets: approximativement de 8 à 8.5 pouces

Medical ID Bracelets / Bracelets d'identification médicale [à graver]



SB727MED
Steel
14mm



TB702MED
Titanium
12mm



BB702MED
Titanium
12mm



RG702MED
Rose Gold Plated
Titanium
12mm



SB850MED
Steel Magnetic
12mm



SB724MED
Steel
11mm



SB803MED
Steel
12mm



BB803MED
Steel
12mm

Length of all bracelets is approximately 8 to 8.5 inches
Longueur de tous les bracelets: approximativement de 8 à 8.5 pouces

Medical ID Bracelets / Bracelets d'identification médicale [à graver]



SB745MED
Steel
10mm



RG745MED
Rose Gold Plated
Steel
10mm



BB310MED
Magnetic Beads/Steel Plate
35 x 10mm
10mm



BB320MED
Magnetic Beads/Steel Plate
35 x 10mm
10mm



RG622MED
Rose Gold Plated
Steel Magnetic
9mm



SRG622MED
Rose Gold Plated
Steel Magnetic
9mm



SB622MED
Steel Magnetic
9mm



SB602MED
Steel
9mm



SB607MED
Steel
6mm



SB605MED
Steel
8mm

Children's bracelets
Bracelets pour enfants

7"

7"

5"+1"
Extension

Medical ID Bracelets / Bracelets d'identification médicale [à graver]



V20201MED Black/Black
Steel Plate
48 x 24mm
20mm



VB760MED
Steel Plate
51 x 24mm
18mm



V20207MED Black/Blue
Steel Plate
48 x 24mm
20mm



SP41MED
Titanium Pendant with
Steel Chain
18 x 40mm



SP57MED
Steel Pendant with
Steel Chain
18 x 40mm



TP60MED
Titanium CZ Stone
Pendant with Steel Chain
20 x 38mm



TP55MED
Titanium CZ Stone
Pendant with Steel Chain
20 x 38mm



SP58MED
Rose Gold Plated
Pendant with Steel Chain
18 x 40mm



LB201MED
Steel Plate Size
45 x 20mm



PL-MED
Steel Plate
48 x 24mm
Fits on 20mm nylon band



N91.1.20L-MED
Steel Plate Size
48 x 24mm

Titanium & Steel Bracelets / Bracelets en titane & en acier inoxydable



Braided bracelets are available in 4 sizes: 7.5, 8.0, 8.5 & 9.0"

Titanium & Steel Bracelets / Bracelets en titane & en acier inoxydable



TB702
Titanium
12mm



TB622
Titanium with
Rubber
11mm



SB745
Steel
10mm



RG745
Rose Gold Plated
Steel
10mm



TB910
Titanium
16mm



SB803
Steel
12mm



SB811
Steel
13.5mm
Self Adjustable Links



SB631
Steel
11mm



TB810
Titanium
16mm



BB803
Steel
12mm



SB724
Steel
11mm

Length of all bracelets is approximately 8 to 8.5 inches
Longueur de tous les bracelets: approximativement de 8 à 8.5 pouces

Pendants & Chains / Pendentifs & Chaînes



TP41-SN
Titanium Pendant
with Steel Chain



SP57
Steel Pendant with
Steel Chain



SP58
Rose Gold Plated
Steel Pendant with
Steel Chain



TP41
Titanium



TP55
Titanium CZ Stone Pendant
with Steel Chain



TP60
Titanium CZ Stone Pendant
with Steel Chain



RGN67-3 – Steel 3mm
Size: 22"



BSN65-2.0 – Steel 2mm
Sizes: 20"



SN67-2 – Steel 2mm
Sizes: 18 & 20"



SN65-2.0 – Steel 2mm
Sizes: 18, 20 & 22"



SN67-3 – Steel 3mm
Sizes: 18 & 20"



SN65-2.3 – Steel 2.3mm
Sizes: 18, 20, 22 & 24"



SN68-4 – Steel 4mm
Sizes: 22 & 24"



SN66-3 – Steel 3mm
Sizes: 18, 22 & 24"

Magnetic Bracelets / Bracelets magnétiques



MSB692
Steel
9mm

MSB696
Steel
9mm

MSB698
Steel
9mm

MSB699
Steel
7mm

MSB685
Steel
8mm

MSB661
Steel
7mm

MSB662
Steel
8mm

MSB710
Copper
9mm

MSB686
Steel
7mm



MBB677
Steel
13mm

MBB680
Steel
12mm

MSB653
Steel
11mm

MSB659
Steel
12mm

MSB666
Steel
12mm

MTB675
Titanium
15mm

IMPORTANT: Magnetic bracelets are not recommended to be used by people fitted with heart pacemakers and by pregnant women. Consult with your doctor if you have any questions.

MISE EN GARDE: Les bracelets magnétiques ne sont pas recommandés pour les porteurs d'un stimulateur cardiaque et pour les femmes enceintes. Veuillez consulter votre médecin si vous avez des questions.

Length of all bracelets is approximately 8 to 8.5 inches
Longueur de tous les bracelets: approximativement de 8 à 8.5 pouces

Titanium Rings / Joncs en titane

What is Titanium?

Titanium is a very lightweight metal weighing only one-third the weight of gold. It is a hard and durable metal used as a main component on NASA space shuttles. It is hypoallergenic, perfect for those with sensitive skin, making it the metal of the new millennium.

Qu'est-ce que le Titane?

Le titane est un métal léger pesant environ le tiers du poids de l'or. C'est un métal solide et robuste utilisé comme composant principal dans les navettes spatiales de la NASA. Le titane est idéal pour les peaux sensibles car il est hypoallergénique. Le titane est le métal du nouveau millénaire!



TR14
Titanium with Diamond
Comfort Fit
7mm



TR20
Comfort Fit
8mm
Sizes: 7 to 13mm



TR3
Comfort Fit
6mm



TR52
Comfort Fit
7mm
Sizes: 5 to 14 only



TR29
Comfort Fit
7mm



TR6
4mm



TR4
Comfort Fit
7mm



TR50
Comfort Fit
8mm
Sizes: 5 to 14 only



TR51
Comfort Fit
8mm
Sizes: 5 to 14 only



TR2
Comfort Fit
7mm



TR7
Comfort Fit
Titanium with Carbon Fibre
6mm



TR10
Comfort Fit
6mm



TR18
Comfort Fit
5mm

All Titanium rings available in size 5, 5.5, 6, 6.5, 7, 7.5, 8, 8.5, 9, 9.5, 10, 10.5, 11, 11.5, 12, 12.5, 13, 13.5, 14, 14.5, 15

Tungsten Rings / Joncs en tungstène

What is Tungsten Carbide?

Tungsten carbide is a very hard, dense metal, twice as hard as steel, ten times harder than 18K gold. It always remains polished and is scratch resistant, providing a strong, sophisticated fashion statement.

Qu'est-ce que le Carbure de Tungstène?

Le carbure de tungstène est un métal très dur et dense. Il est deux fois plus dur que l'acier et dix fois plus dur que l'or 18 carats. Ce métal maintient un fini poli et résiste aux égratignures. Une touche à la fois audacieuse et sophistiquée !



TUR11
Comfort Fit
with CZ Stone
7mm



TUR14
Comfort Fit
7mm



TUR12
Comfort Fit
2 Tone Gold Plated
8mm



TUR37
Comfort Fit
8mm
Sizes: 6 to 14 only



TUR34
Comfort Fit
6mm



TUR28
Comfort Fit
7mm



TUR15
Comfort Fit
6mm



TUR19
Comfort Fit
6.5mm



TUR33
Comfort Fit
Tungsten with Carbon Fibre
7mm



TUR21
Comfort Fit
Tungsten with Carbon Fibre
8mm



TUR38
Comfort Fit
7mm
Sizes: 6 to 14 only



TUR29
Comfort Fit
7mm



TUR31
Comfort Fit
6mm



TUR32
Comfort Fit
5mm



TUR10
Comfort Fit
8mm
Sizes: 7 to 13mm



TUR30
Comfort Fit
7mm



TUR36
Comfort Fit
8mm



TUR35
Comfort Fit
8mm



TUR17
Comfort Fit
7mm

All Tungsten rings available in size 5, 5.5, 6, 6.5, 7, 7.5, 8, 8.5, 9, 9.5, 10, 10.5, 11, 11.5, 12, 12.5, 13, 13.5, 14, 14.5, 15

Cobalt Rings / Joncs en cobalt

Fabulous Cobalt Rings!

For many years, Alpine has offered collections of remarkable wedding bands in alternative metals such as tungsten and titanium. Now, we bring you the new generation of contemporary metal. Cobalt rings are made from a unique alloy blend of cobalt and additives. The natural bright, white color never fades or discolors and is often compared to platinum. Cobalt is an incredibly hard metal and provides uncompromising strength. Cobalt is shatterproof, scratch resistant and hypoallergenic. Cobalt rings can be stretched up to half a size.

Joncs en cobalt spectaculaires !

Depuis plusieurs années, Alpine International offre une sélection exceptionnelle de joncs en métaux alternatifs tels que le tungstène et le titane. Il s'agit d'une nouvelle génération de métaux. Les joncs en cobalt sont fabriqués à partir d'un alliage unique de cobalt et d'autres additifs. Sa couleur naturelle vive, que l'on compare souvent à la platine, ne se décolore jamais. Le cobalt est un métal dur et résistant. Il est incassable, résiste aux égratignures et il est hypoallergénique. La taille du jonc peut être augmentée d'un demi-point.



CR22
Comfort Fit
7.5mm
[6-14]



CR23
Comfort Fit
7mm
[6-14]



CR24
Comfort Fit
7mm
[6-14]



CR30
Comfort Fit
Cobalt with Ceramic
8mm
[8-12]



CR25
Comfort Fit
8mm
[6-14]



CR14
Comfort Fit
7mm
[6-14]



CR17
Comfort Fit
7mm
[6-14]



CR19
Comfort Fit
6.5mm
[6-14]



CR26
Comfort Fit
5mm
[6-14]



CR8
Comfort Fit
7mm
[6-14]



CR27
Comfort Fit
6.5mm
[6-14]



CR29
Comfort Fit
Cobalt with CZ Stone
7mm
[8-12]



CR28
Comfort Fit
Cobalt with Carbon Fibre
7mm
[6-14]

[6-14] Cobalt rings available in size 6, 6.5, 7, 7.5, 8, 8.5, 9, 9.5, 10, 10.5, 11, 11.5, 12, 12.5, 13, 13.5, 14
[8-12] Cobalt rings available in size 8, 8.5, 9, 9.5, 10, 10.5, 11, 11.5, 12

Engravable Cufflinks / Boutons de manchettes à graver



SC50



SC78
Cat Eye



SC127



SC61
Austrian Crystals



SC32



SC49



Gift Box Included
(boîte cadeau comprise)



SC154



SC11
Steel with CZ



SC35



SC153



TTC71

Tie Bars / Pinces à cravate



ST38
Austrian Crystals



ST24
Steel with CZ
Stone



ST34
Austrian Crystal



ST42
with Carbon Fibre



ST32
Austrian Crystals



ST33



ST39

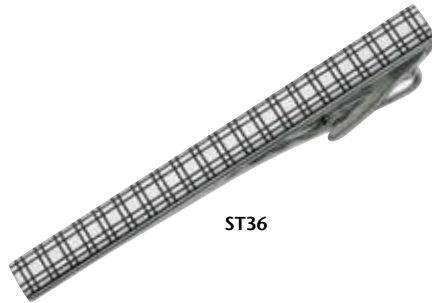

ST36



ST37
Black Onyx



ST40



ST41



ST44



ST49



ST48

Gift Box Included
(boîte cadeau comprise)

Cufflink & Tie Bar Sets - Ensembles de Boutons de manchettes & Pincés à cravate



Money Clips / Pinces à billets

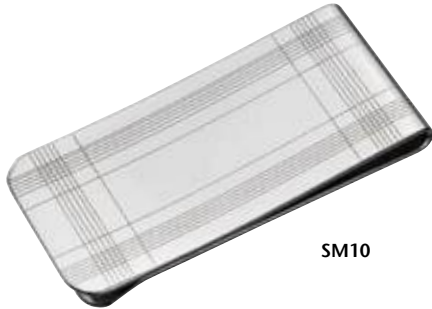

SM10



SM20
Steel with
Carbon Fibre



TM34
Titanium



SM38



SM39



SM42



SM49



SM47



Gift Box Included
(boîte cadeau comprise)

Engravable Key Chains / Porte-clés personnalisés gravés
 Business Card Holders / Porte-cartes professionnelles



A414



A412



A413



A411



B901



All key chains are packed in box.
 Porte-clés sont tous emballés
 dans une boîte



B922



B924



B921



C101
 Shiny



C110



B923



B925



C102

Engravable Key Chains / Porte-clés personnalisés gravés
 Business Card Holders / Porte-cartes professionnelles



Business Card Holders / Étuis pour Cartes professionnelles

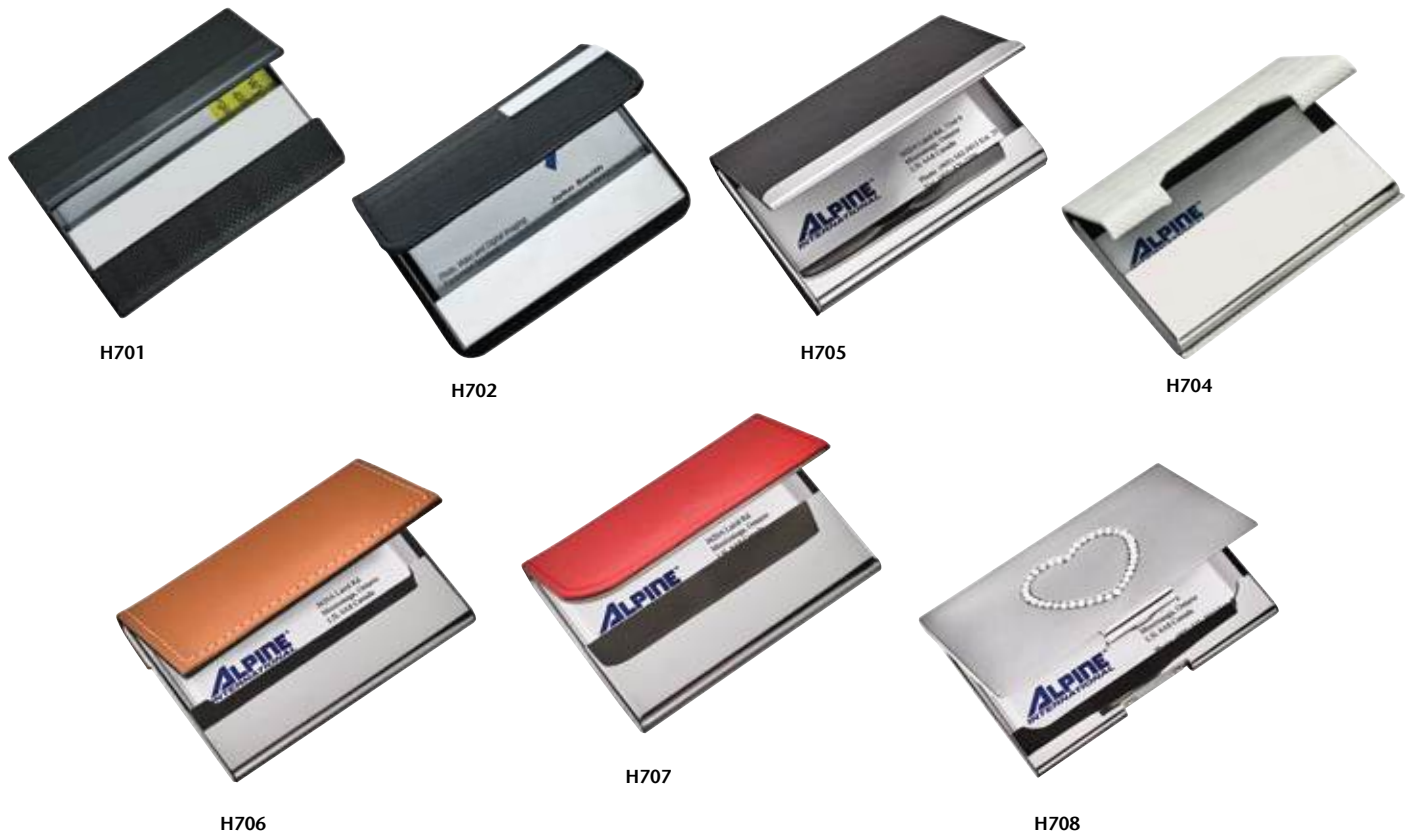

1400 Series with Die Cut Pad /
Série 1400 avec tampon découpé



◀ RING
1400.R
1 7/8 x 1 3/4 x 1 5/16



▲ NECKLACE
1400.N
6 3/4 x 6 3/4 x 1 1/4



▲ BRACELET
1400.B
8 3/4 x 2 x 1 1/4



▲ UNIVERSAL
1400.U
3 5/8 x 3 5/8 x 1 1/4



▲ EARRING
1400.E
1 7/8 x 1 3/4 x 1 5/16



◀ PENDANT
1400.P
2 7/16 x 3 x 1 5/16

3600 Series / Boîtiers série 3600



◀ BRACELET
3600.B
8 ¼ x 2 x 1



▲ DOUBLE RING
3600.DR
2 ¼ x 1 ¾ x 1 ½

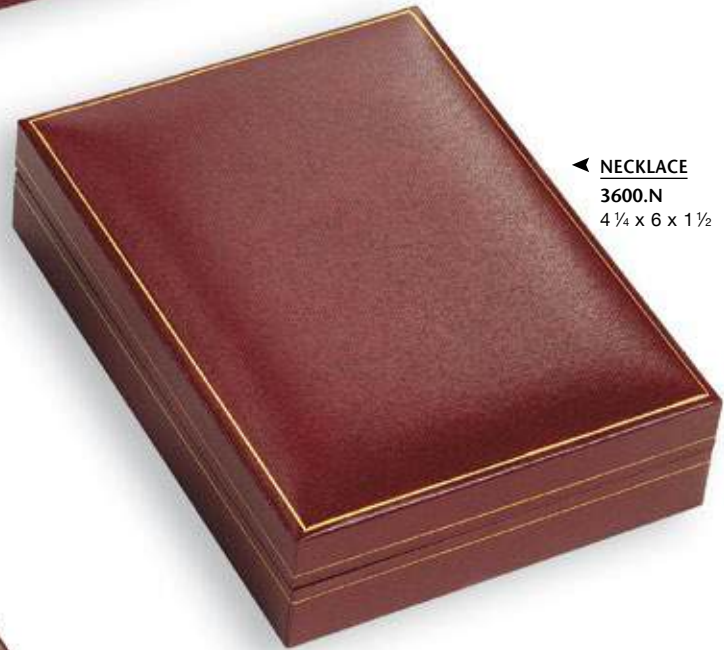

◀ NECKLACE
3600.N
4 ¼ x 6 x 1 ½



▶ PENDANT
3600.P
2 ½ x 2 ⅝ x 1 ½



▲ HOOP EARRING
3600.LE
2 ½ x 2 ⅝ x 1 ½



▶ EARRING
3600.E
1 ¾ x 2 x 1 ½



◀ RING
3600.R
1 ¾ x 2 x 1 ½

Boxes can be imprinted. Imprint charges \$0.50 per print, minimum \$50.00.
Coûts d'impression des boîtiers : 0,50 \$ l'unité; minimum 50,00 \$

3700 Series Boxes /
Boîtiers série 3700



▶ **PENDANT**
3700.P

2 ½ x 2 ¾ x 1 ½



▲ **BRACELET**
3700.B
8 ¾ x 2 x 1



◀ **HOOP EARRING**
3700.LE
2 ¾ x 2 ¾ x 1 ½



▲ **CUFFLINK**
3700.CL
2 ¾ x 1 ¾ x 1 ½



▲ **RING**
3700.R
1 ¾ x 2 x 1 ½



▶ **NECKLACE**
3700.N
4 ¼ x 6 x 1 ½



▲ **EARRING**
3700.E
1 ¾ x 2 x 1 ½

Boxes can be imprinted. Imprint charges \$0.50 per print, minimum \$50.00.
Coûts d'impression des boîtiers : 0,50 \$ l'unité; minimum 50,00 \$

5600 Series Boxes / Boîtiers série 5600



◀ RING
5600.R
2 ¼ x 2 ¼ x 1 ⅞



▲ NECKLACE
5600.N
5 x 6 ½ x 2 ⅞



◀ BRACELET
5600.B
9 ½ x 2 ¼ x 1 ½



◀ DOUBLE RING
5600.DR
3 x 2 ¼ x 1 ⅞



▲ EARRING
5600.E
2 ¼ x 2 ¼ x 1 ⅞



▶ SMALL PENDANT
5600.SP
3 x 3 ½ x 1 ⅞

Boxes can be imprinted. Imprint charges \$0.50 per print, minimum \$50.00.
Coûts d'impression des boîtiers : 0,50 \$ l'unité; minimum 50,00 \$

4100 Series Boxes / Boîtiers série 4100



HOOP EARRING ►
4100.4.LE
3 x 3 ¼ x 1 ¼



◀ EARRING
4100.4.E
2 x 2 ¼ x 1 ½



▲ BRACELET
4100.4.B
9 x 2 ¾ x 1 ½



◀ RING
4100.4.R
2 x 2 ¼ x 1 ½



PENDANT ►
4100.4.P
3 x 3 ¼ x 1 ¼

Boxes can be imprinted. Imprint charges \$0.50 per print, minimum \$50.00.
Coûts d'impression des boîtiers : 0,50 \$ l'unité; minimum 50,00 \$

Ahead of its time.

We are the world's leading manufacturer of silver oxide batteries.
It's because of us that Swiss watches tick so reliably.



No ticking without a Renata battery.

Your watch definitely deserves a Swiss made Renata battery.

www.renata.com

renata 
batteries

Authorized Distributor

**RELIABLE WATCH MATERIALS
JEAN MICHEL**

1435 St - Alexandre, Suite 410, Montréal (Québec) H3A 2G4
Tél (514) 866-1095 / (514) 866-3761

Tél: 1-800-465-6735 • Fax: National 1-800-565-6735

Fax: (514) 866-6870

www.reliablewatch.ca

**ALPINE
INTERNATIONAL**

3620A Laird Rd Unit 6, Mississauga, ON L5L 6A8
(905) 542-3913 • F: 905-826-3396 • TF: 1-866-542-3963
info@alpineselection.com • www.alpineselection.com