

dapol

Gauge

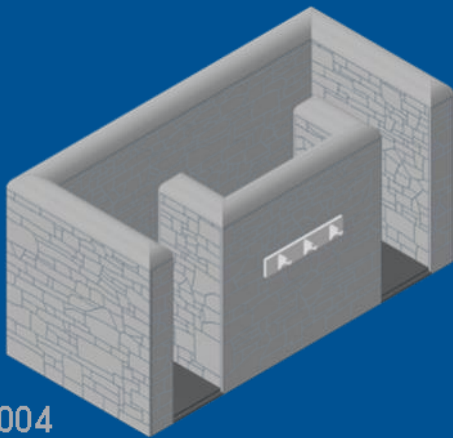

7B-003-004

Lynton & Barnstaple Gentleman's Toilets

Based on Chelfham, Devon



Read Before Building

Estimated Build Time:

1-2 hours

This is a very complex kit, we strongly recommend taking your time building it. It is also very important to keep a clean work area as the card is permeable and can stain very easily.

We recommend using a standard PVA glue slightly diluted with water. We do not recommend any fast drying glues, as they can dry too quickly, making any small positional adjustments difficult. It's best to apply the glue using a small paintbrush or cardboard offcut.

Parts cannot be bought individually. Spare or replacement frets can be bought £10 each for large frets and £7 each for small frets by contacting sales@dapol.co.uk

Printed instructions are available free of charge by contacting sales@dapol.co.uk

But most of all. Enjoy.

Checklist

- Real Grey 10

- A1

- A3

- C1

- C3

- Real Grey 11

- B1

- B3

- Real Grey 12

- E1

- E3

- F1

- F3

- G1

- G3

- Real Grey 13

- D1

- D2

- H1

- H3

- K1 (x2)

- Smoke 10

- J1

- J2

- White 56

- A2

- A4

- C2

- C4

- White 57

- B2

- B4

- White 58

- E2

- E4

- F2

- F4

- G2

- G4

- White 59

- A5

- B5 (x2)

- C5

- D3 (x2)

- H3 (x2)

1

J1 & J3

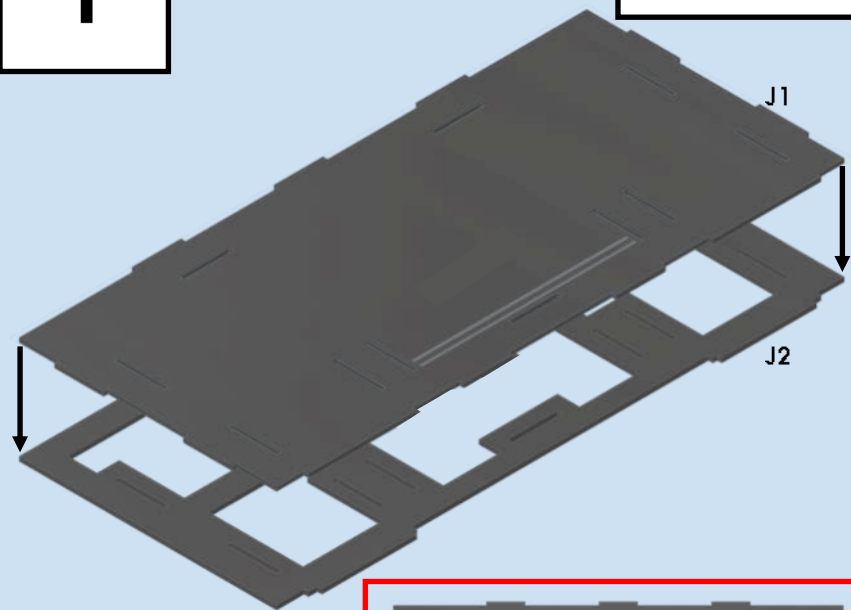

2

F3 & F4

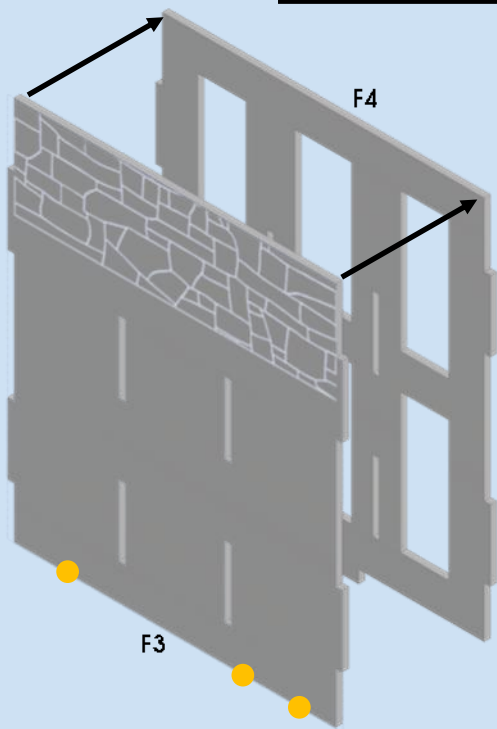
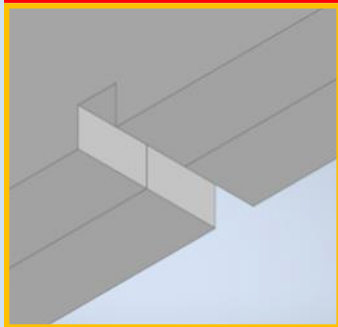
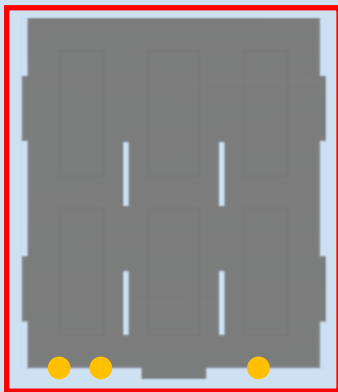

3

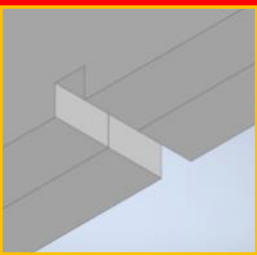
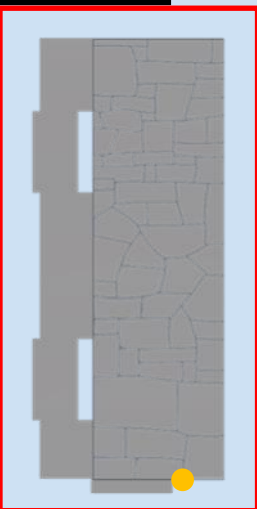

E3 & E4

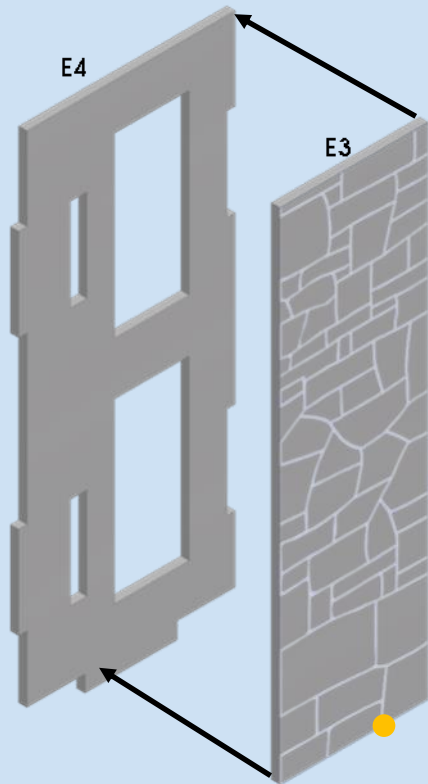

4

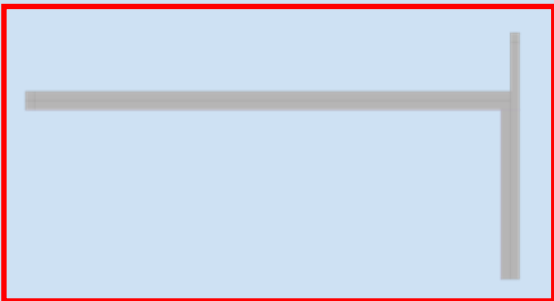
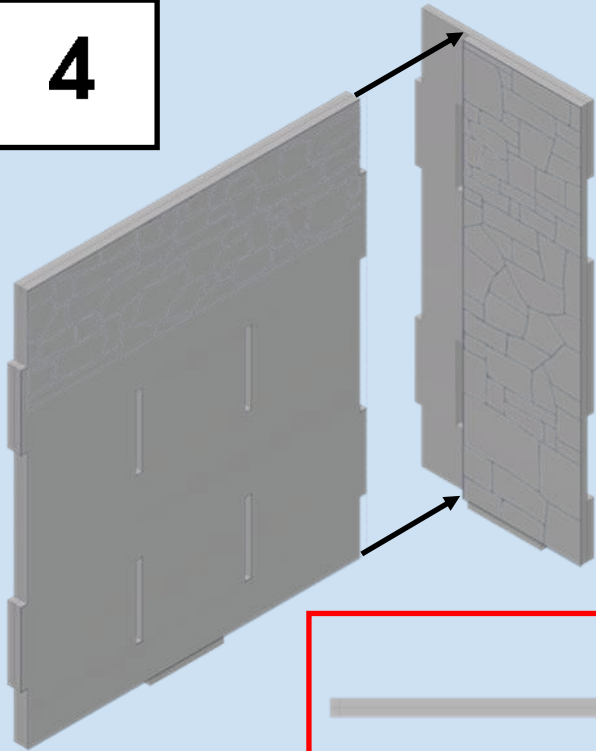

5

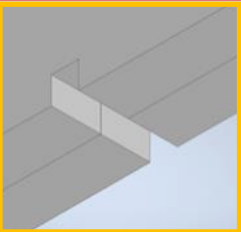
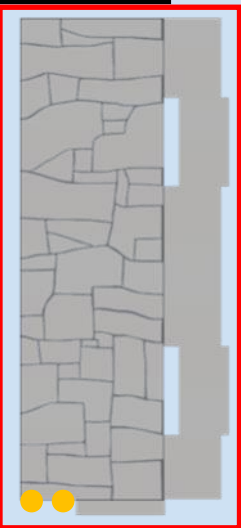

G3 & G2

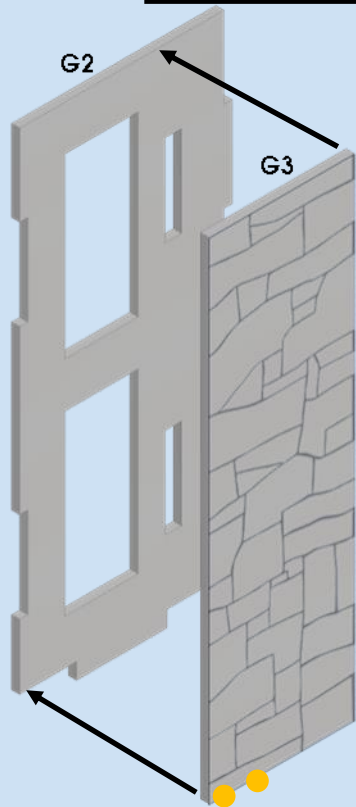

6

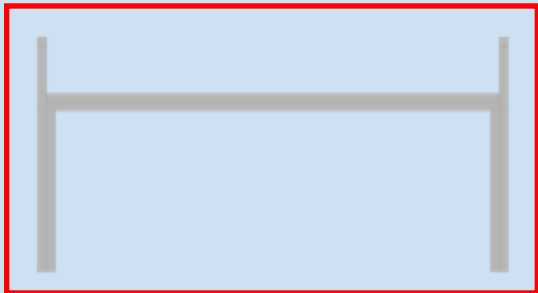
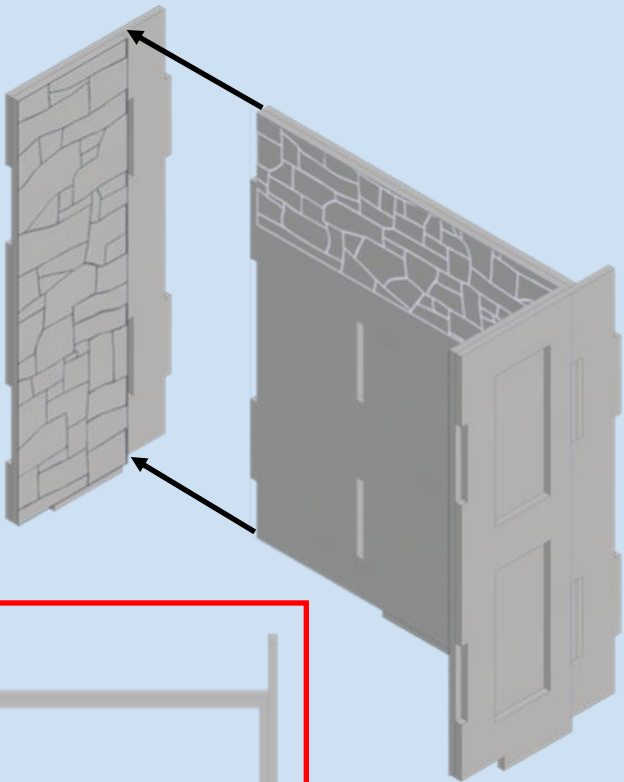

7

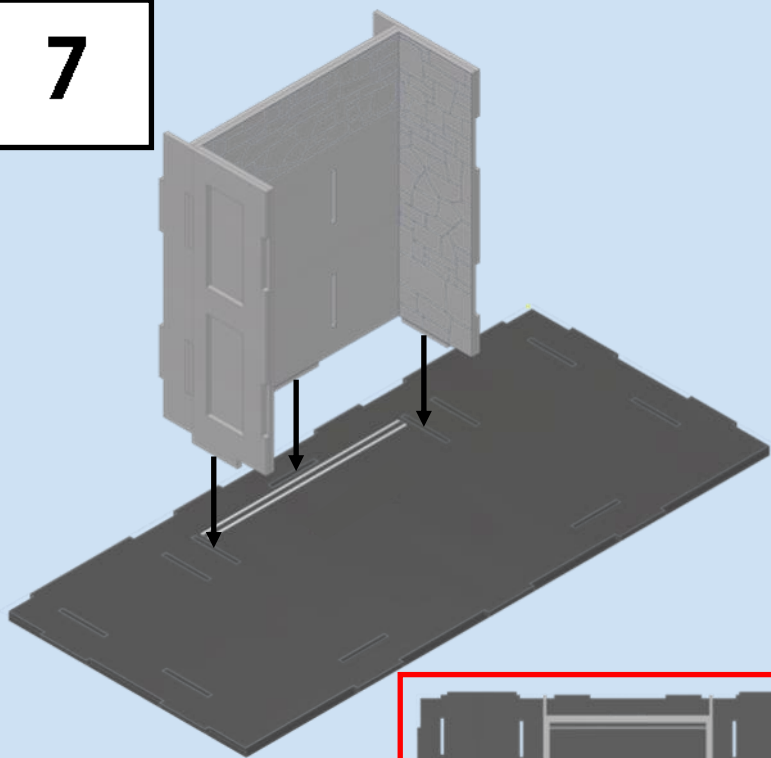

8

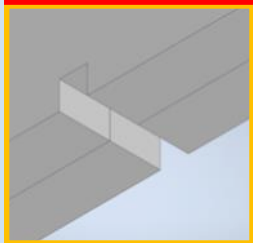
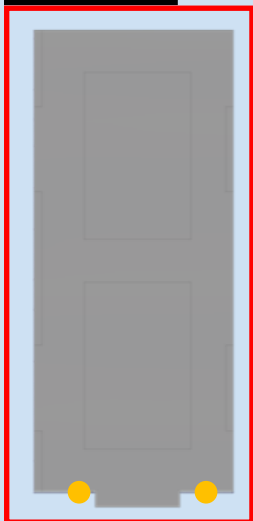

E1 & E2

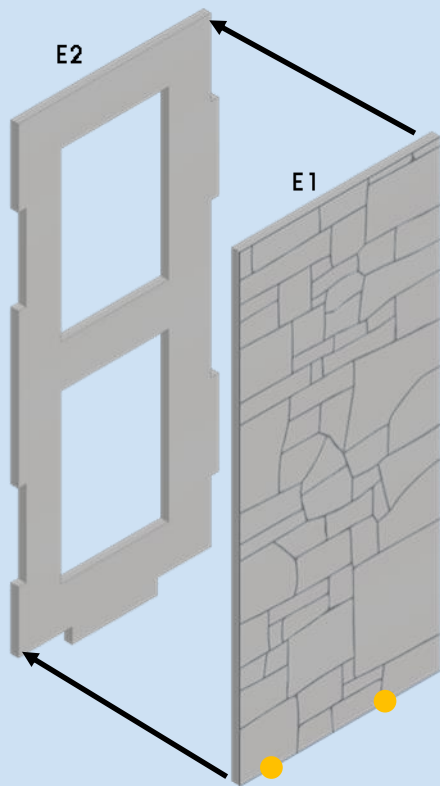

9

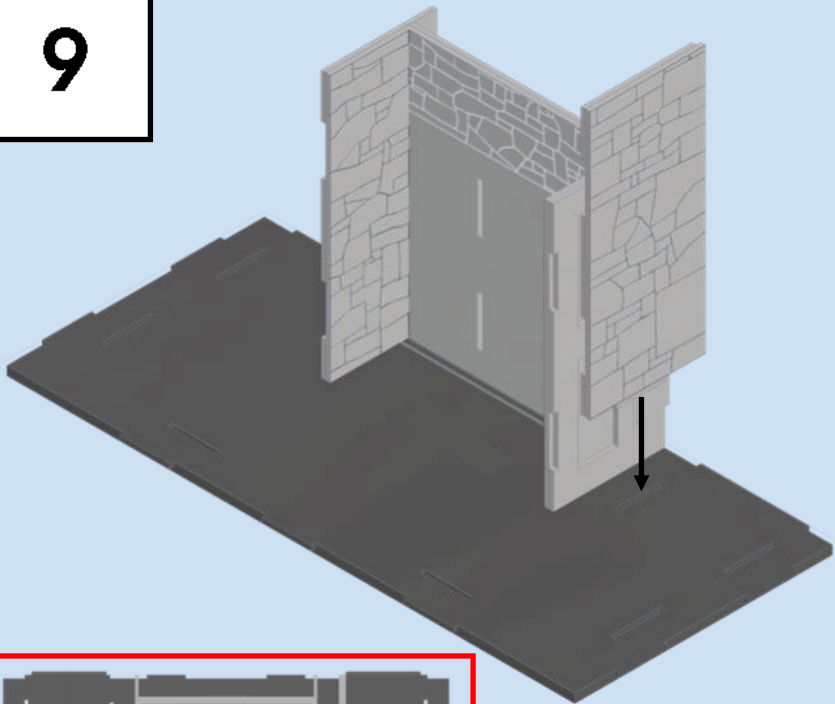

10

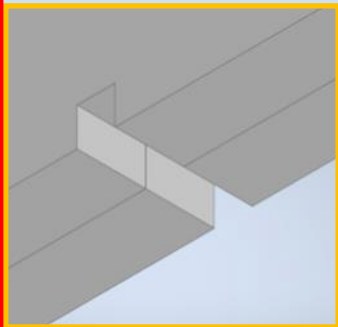
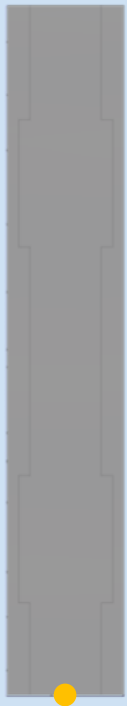

H1 & H3

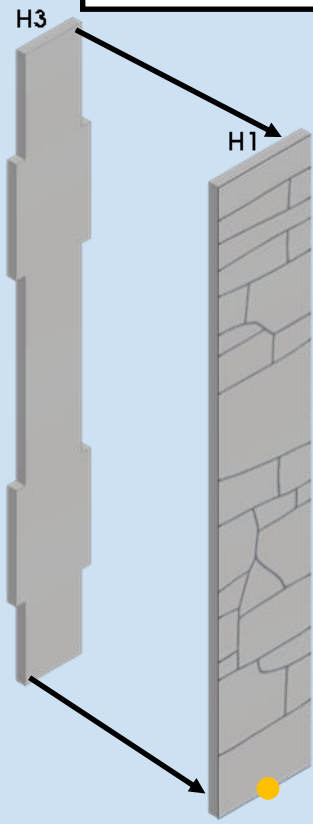

11

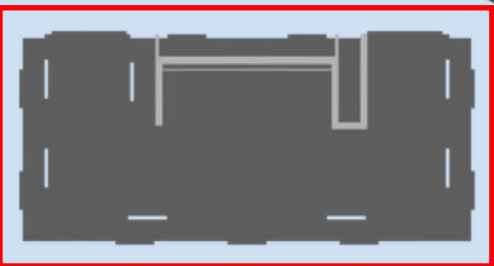
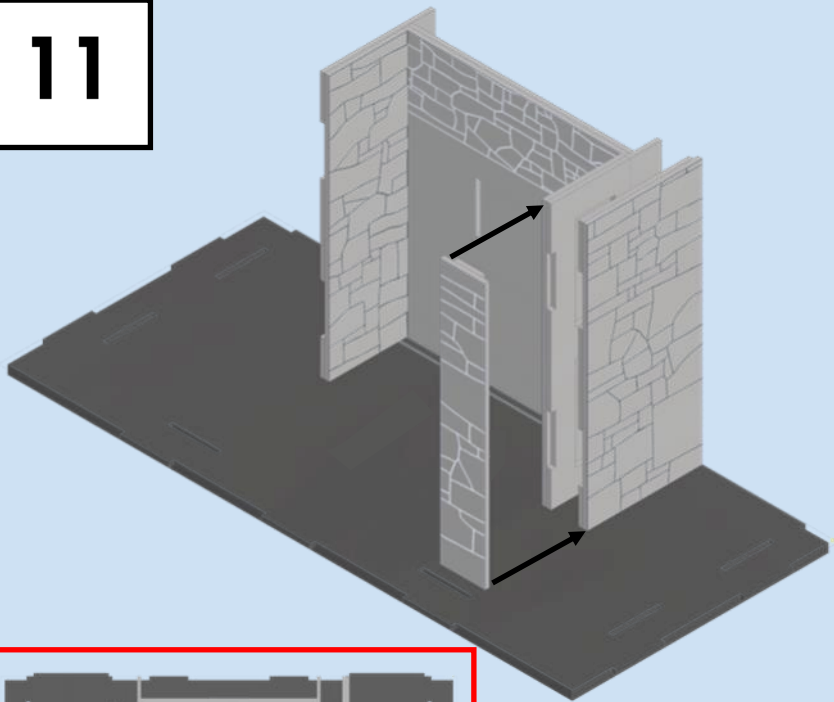

12

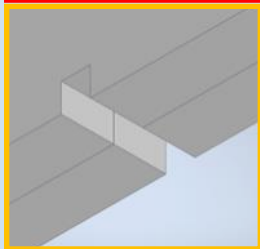
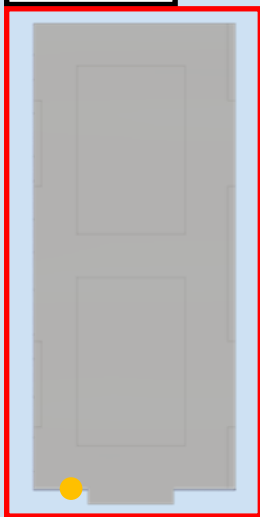

G1 & G4

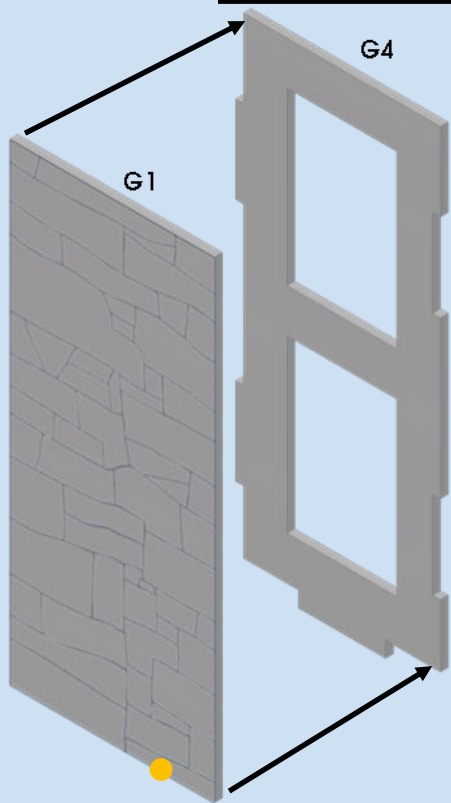

13

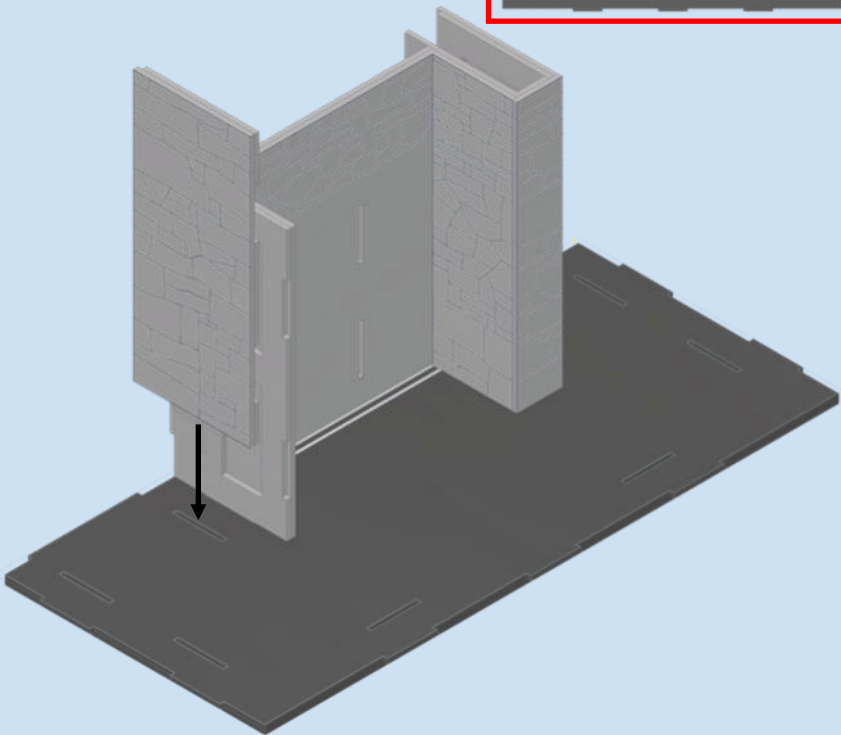

14

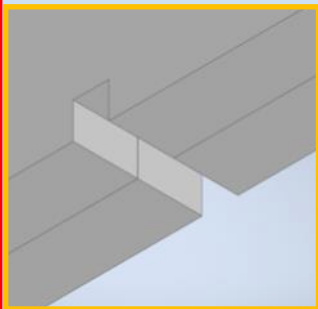
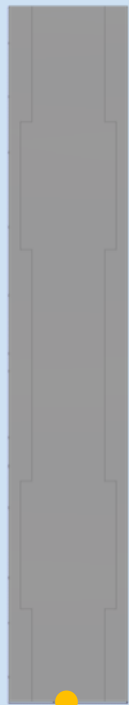

H2 & H3

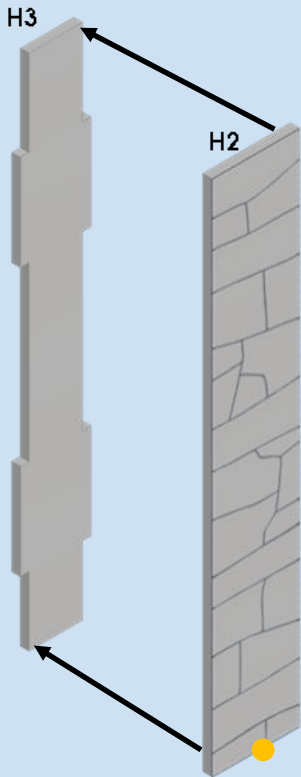

15

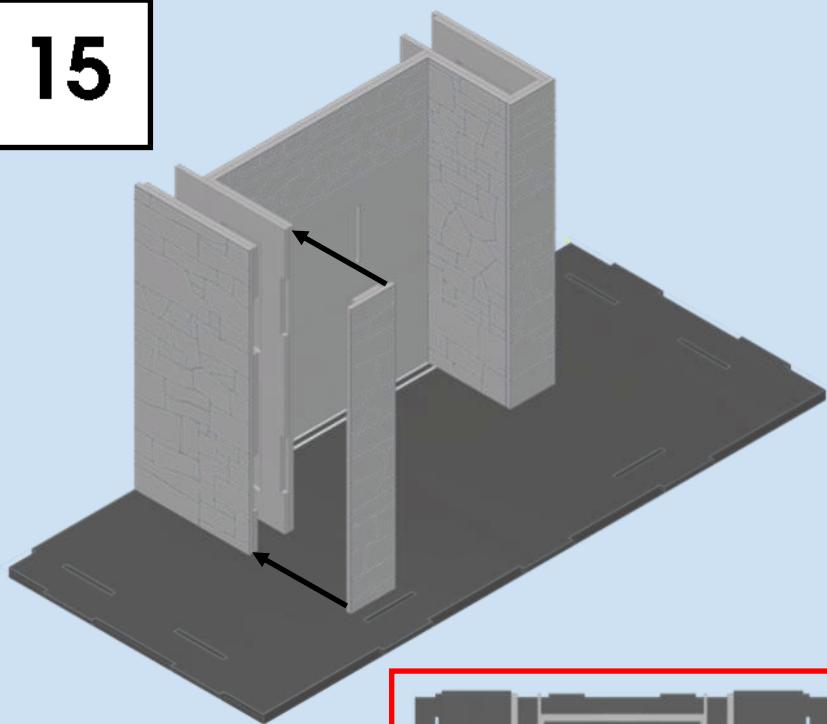

16

F1 & F2

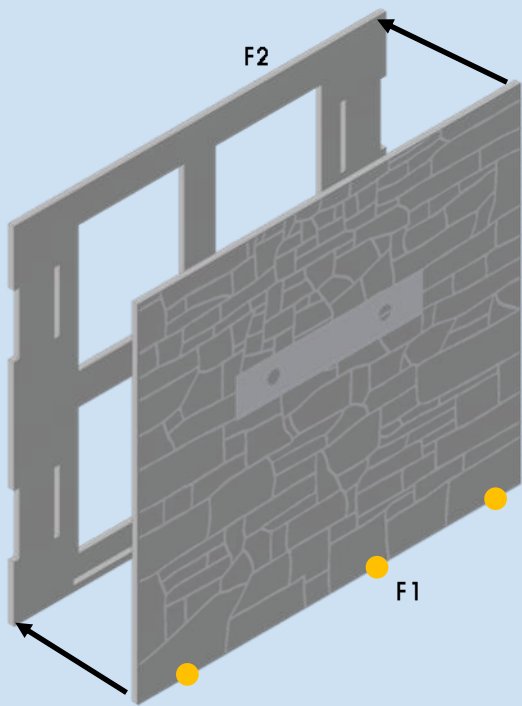
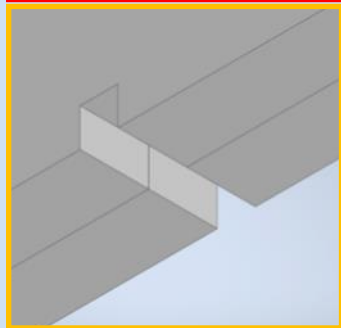
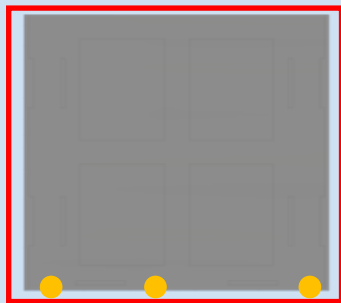

17

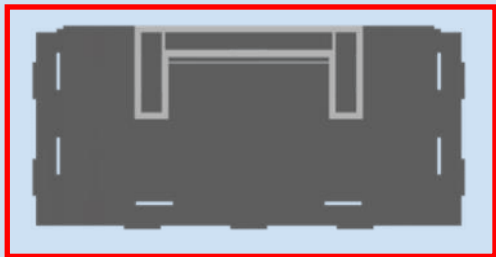
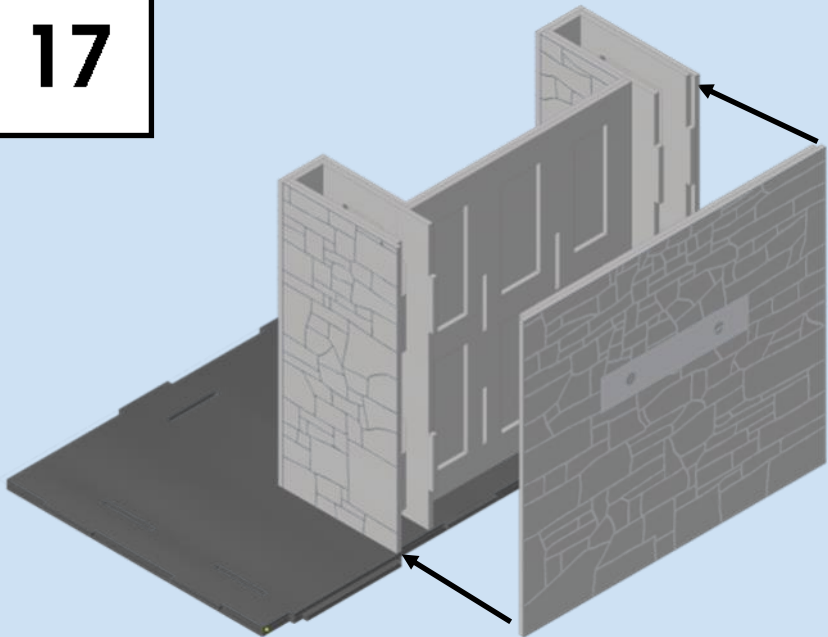

18

K1 (x2)

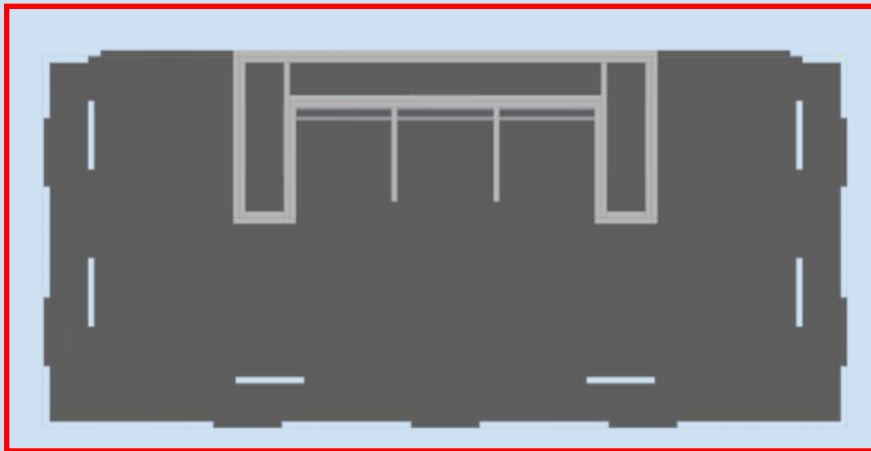
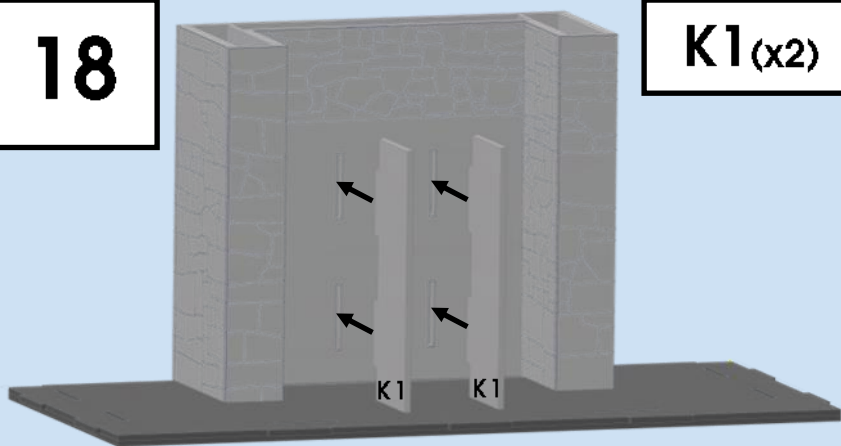

19

B3 & B4

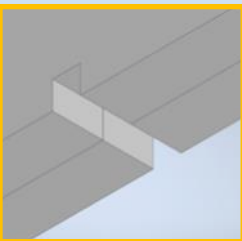
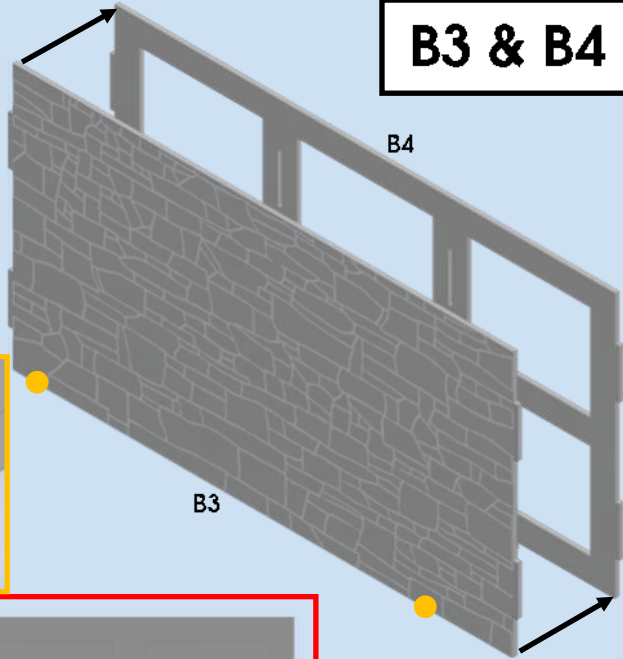

20

A3 & A4

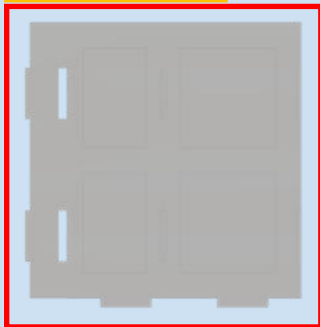
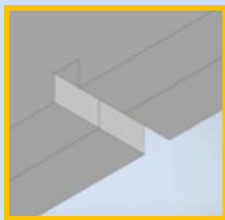
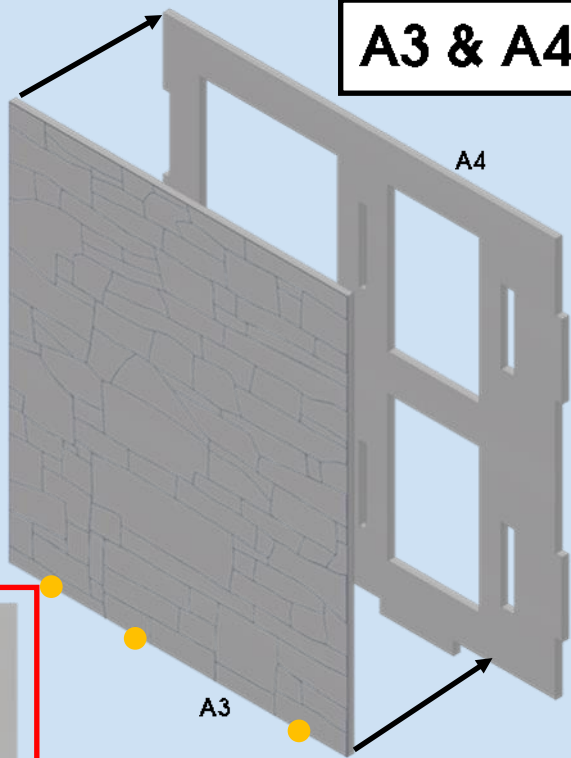

21

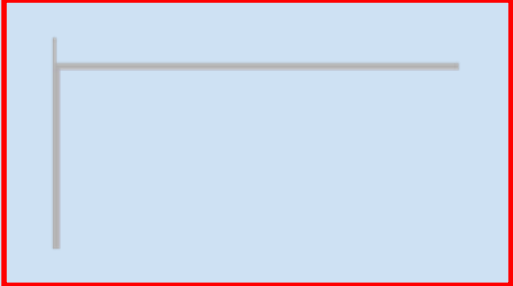

22

C3 & C4

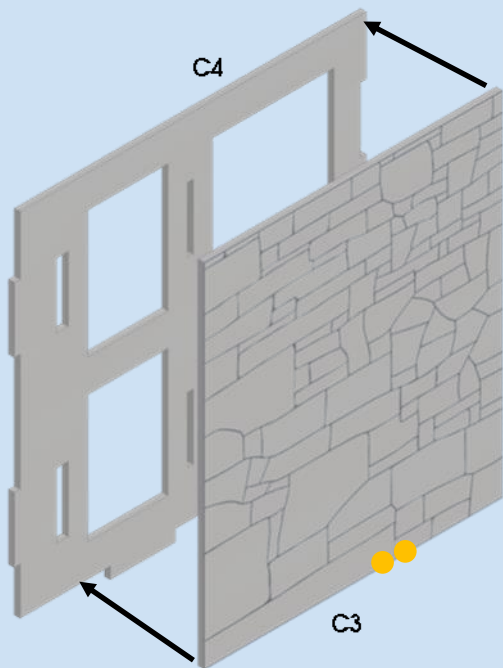
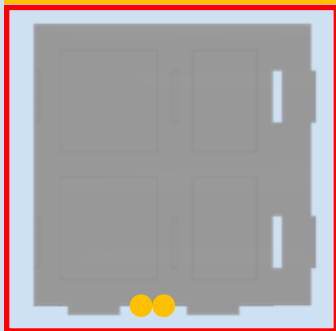
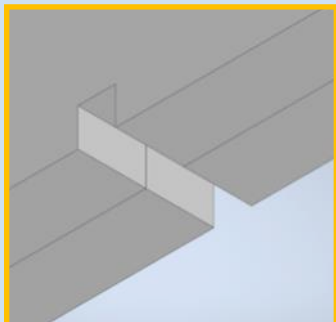

23

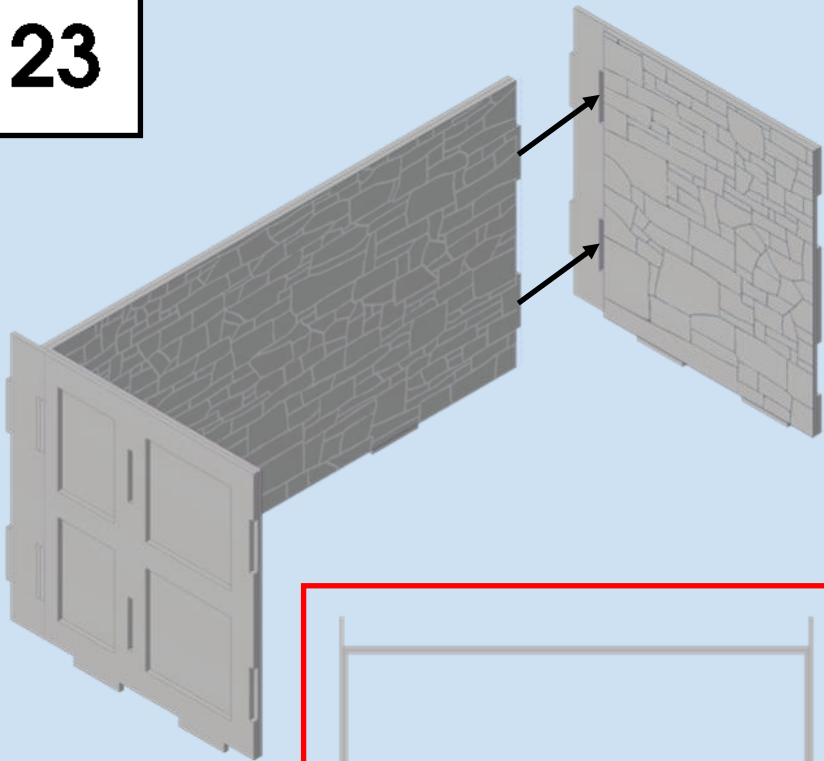

24

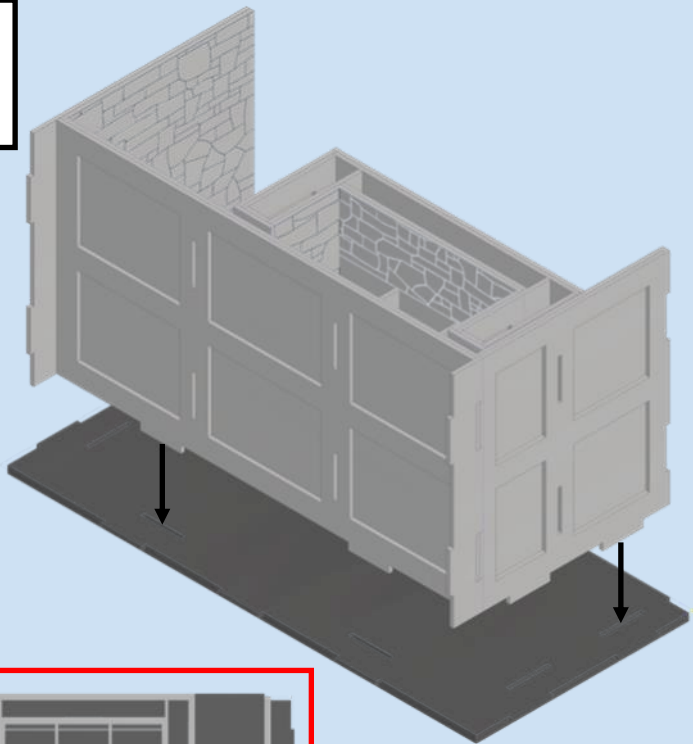

25

B5(x2)

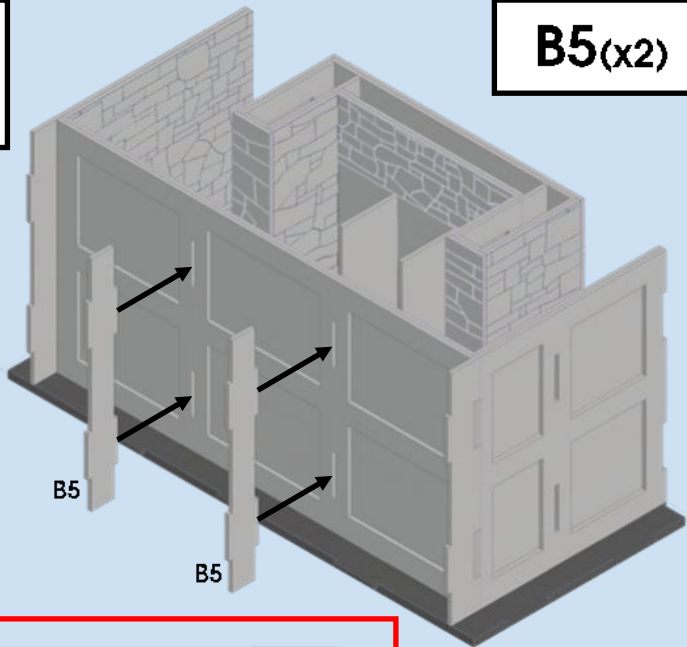

B5

B5



26

B1 & B2

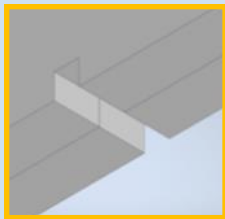
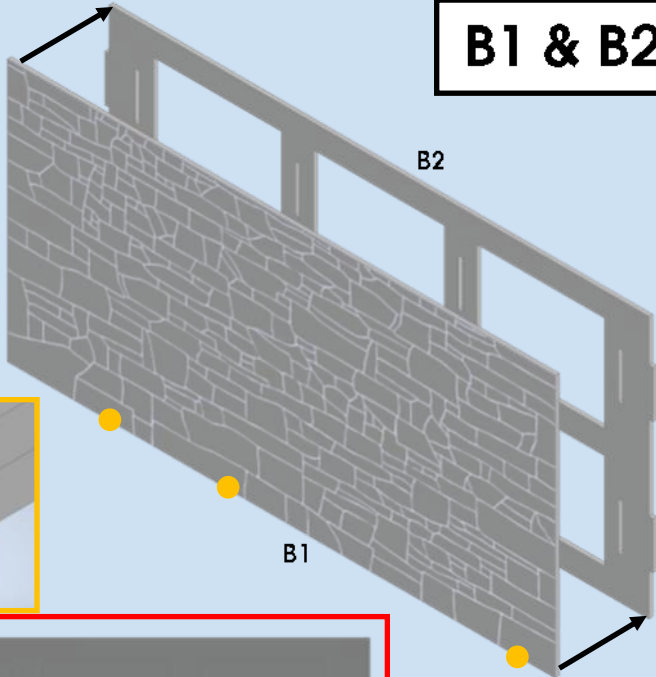

27

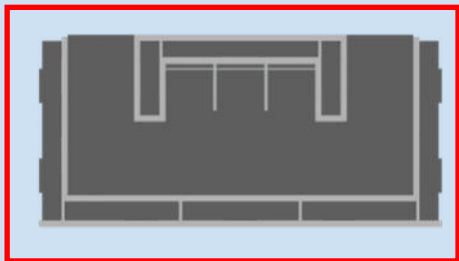
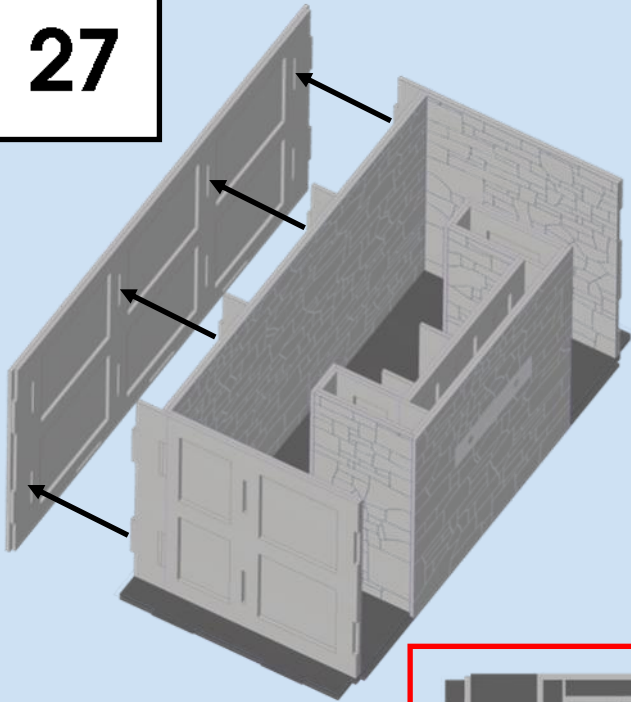

28

A5

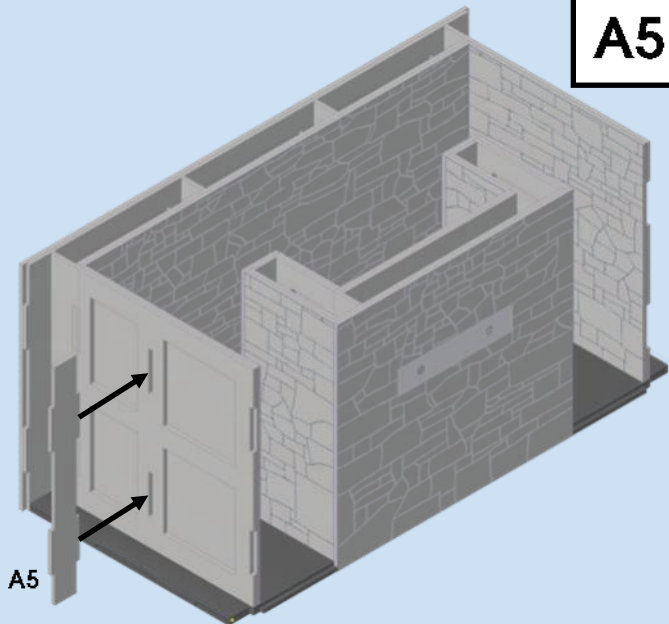

A5

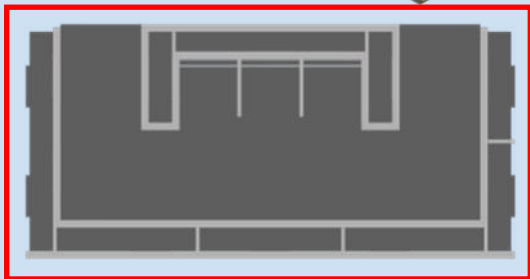

29

A1 & A2

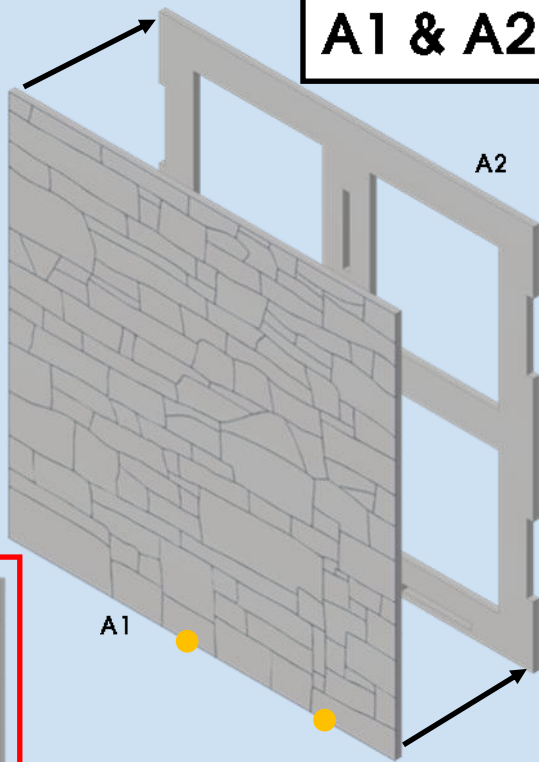
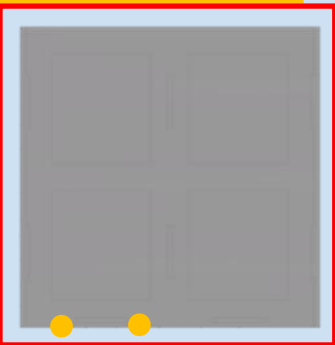
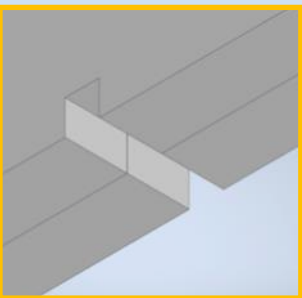

30

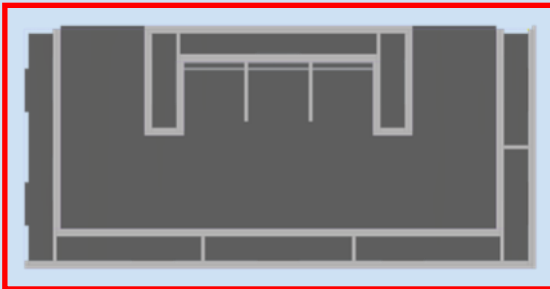
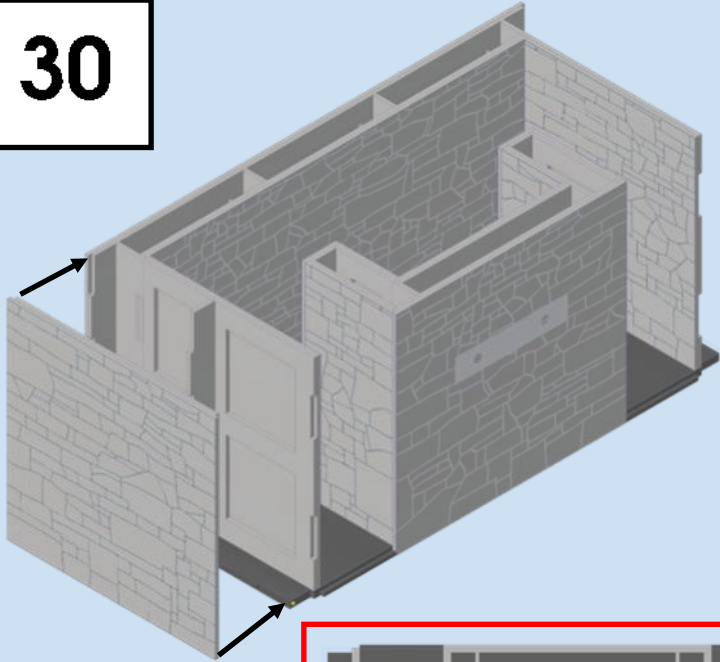

31

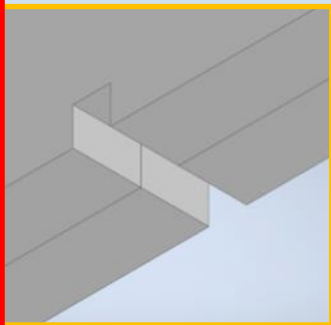

D1 & D3

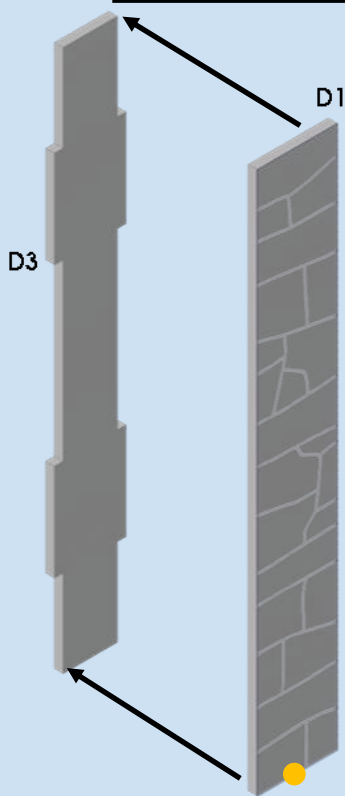

32

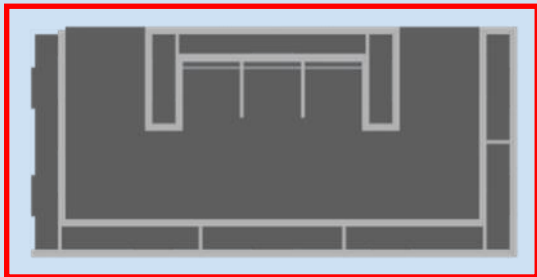
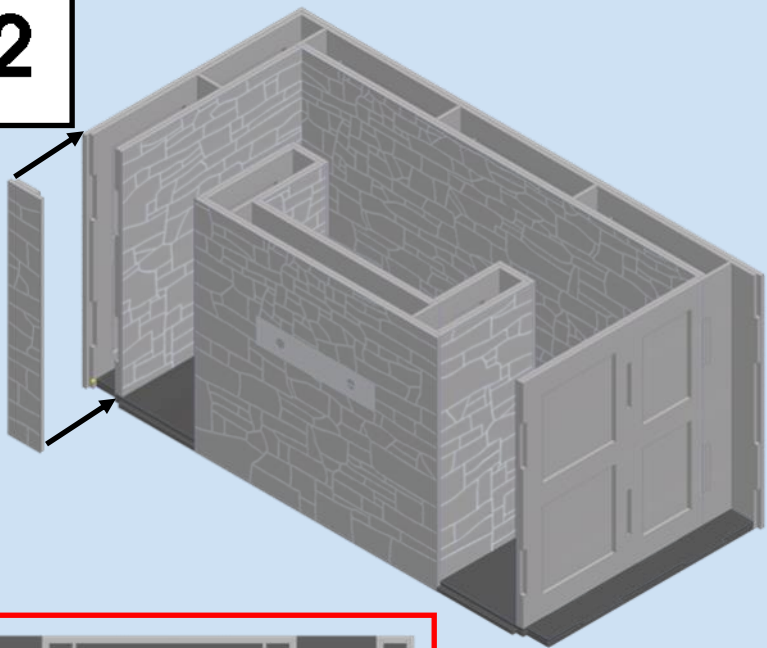

33

A5

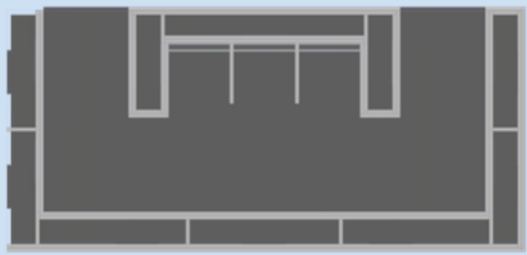
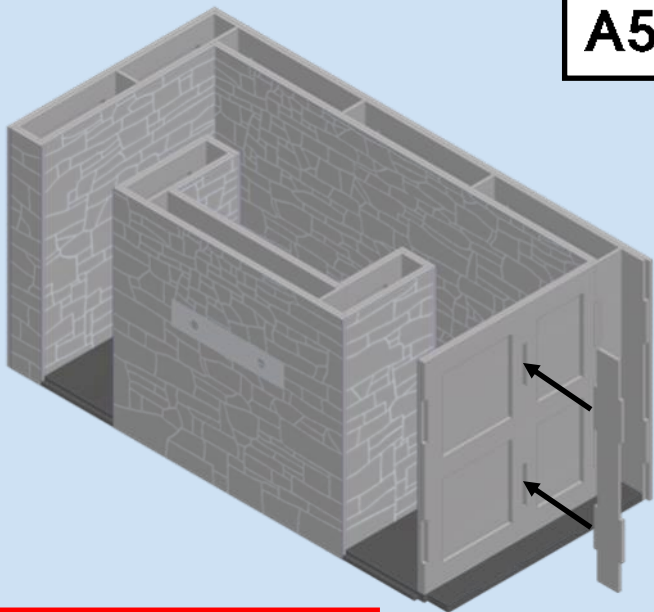

34

C1 & C2

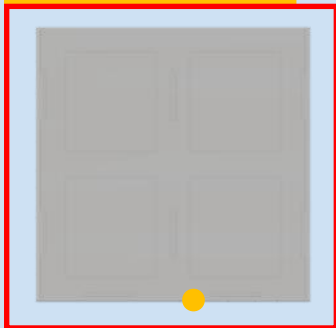
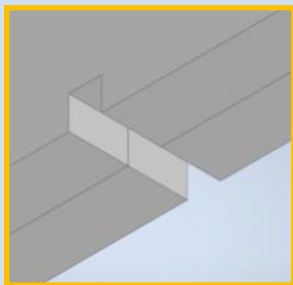
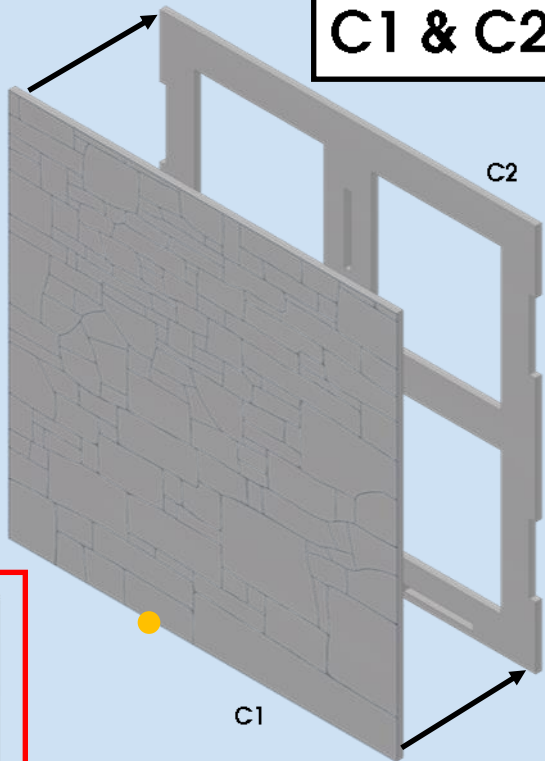

35

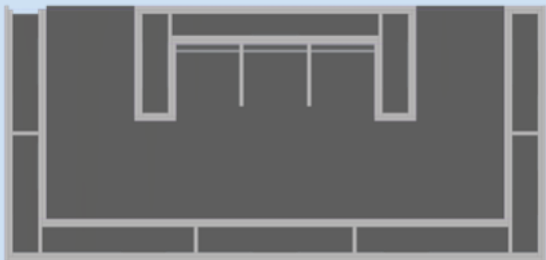
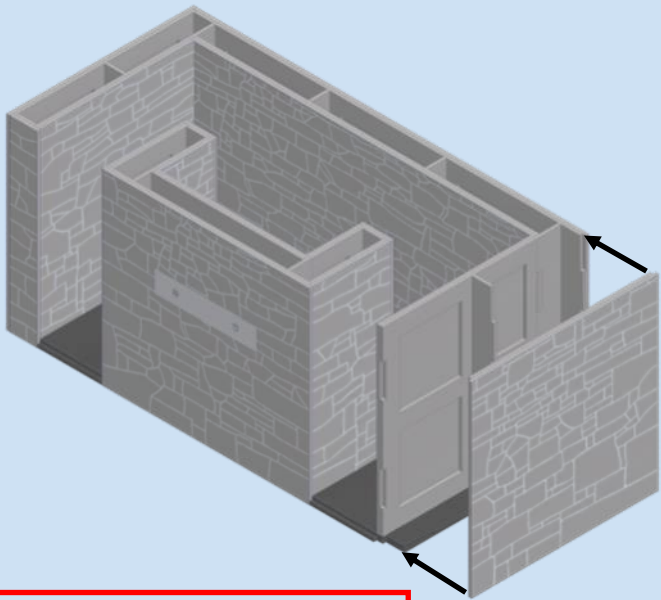

36

D2 & D3

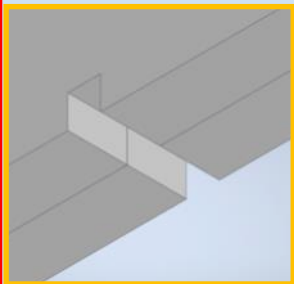
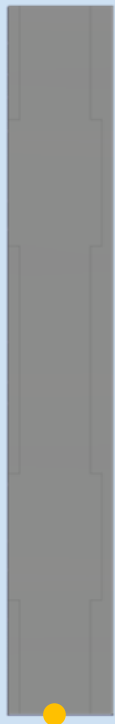

D2

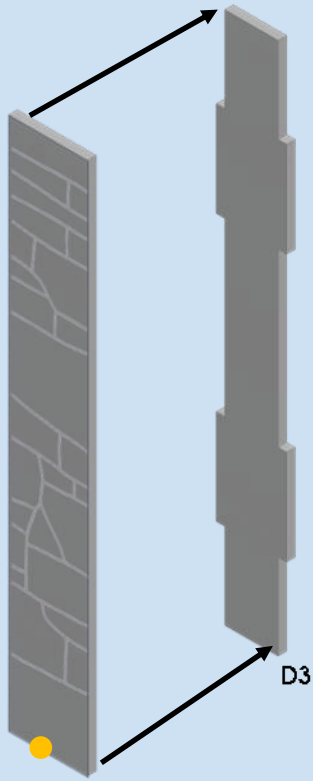

D3

37

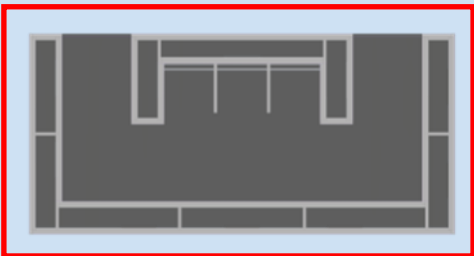
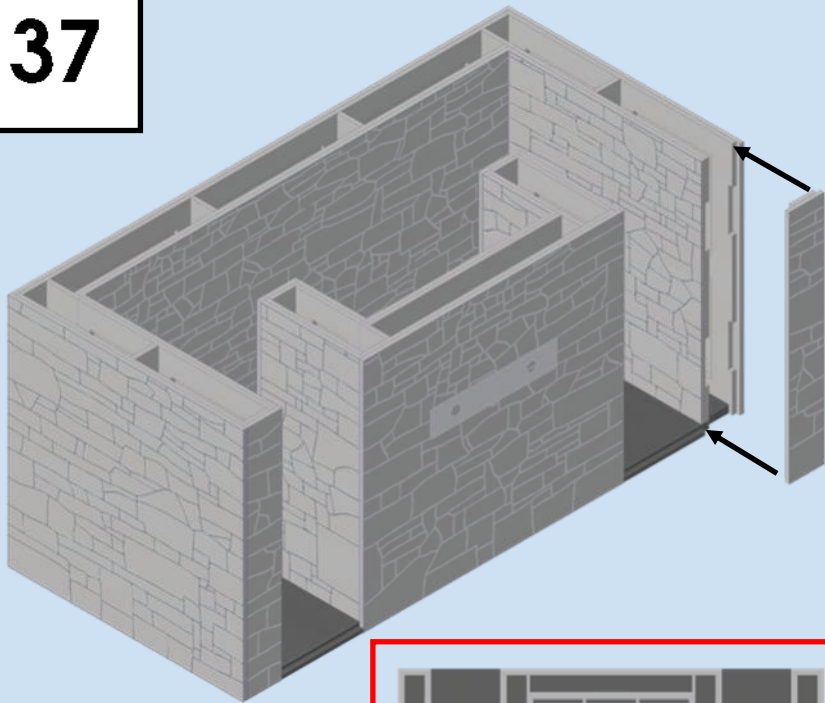

38

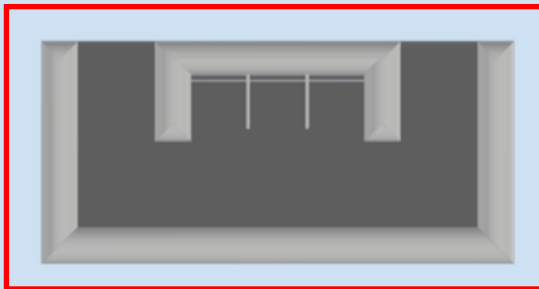
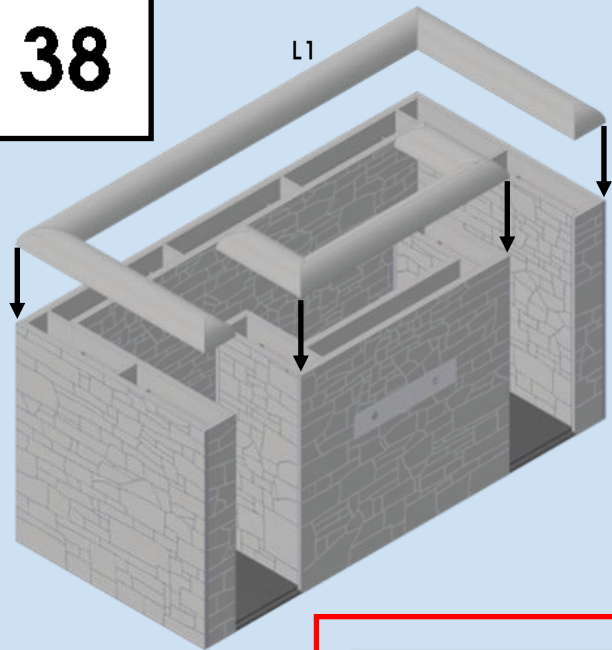

39

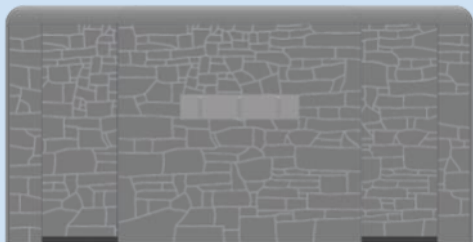
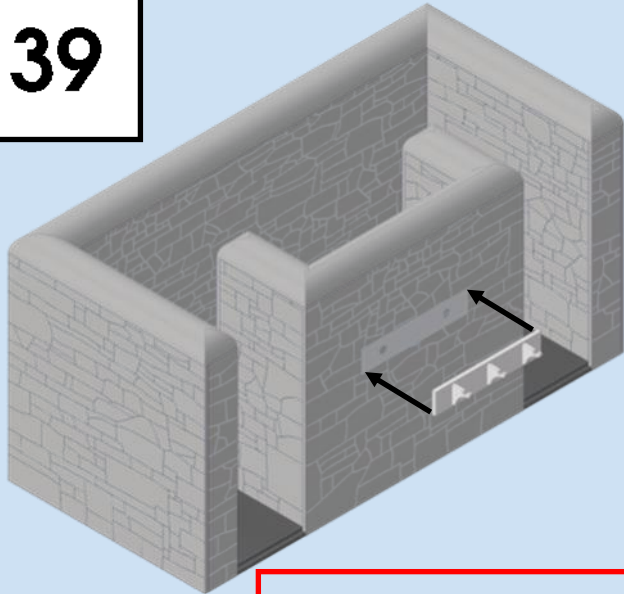

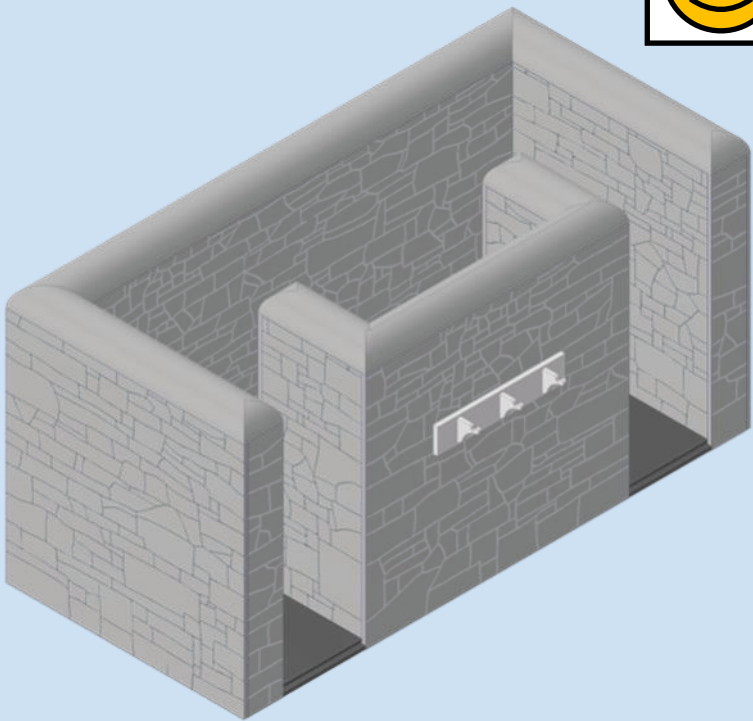

The logo for 'dapol' is centered on a blue background. The word 'dapol' is written in a lowercase, italicized, sans-serif font. It is enclosed within a thin, light gray rectangular border that follows the slant of the text. The background is split into a blue section on the right and a gray section on the left, separated by a white curved line.

dapol