

# dapol

Gauge



7B-003-002

Lynton & Barnstaple Railway Small Station Building

Based on Chelfham

**Kitmaster**   
TRADE MARK  
GENESIS

# Read Before Building

**Estimated Build Time:**

**6-8 hours**

This is a very complex kit, we strongly recommend taking your time building it. It is also very important to keep a clean work area as the card is permeable and can stain very easily.

We recommend using a standard PVA glue slightly diluted with water. We do not recommend any fast drying glues, as they can dry too quickly, making any small positional adjustments difficult. It's best to apply the glue using a small paintbrush or cardboard offcut.

Parts cannot be bought individually. Spare or replacement frets can be bought £10 each for large frets and £7 each for small frets by contacting [sales@dapol.co.uk](mailto:sales@dapol.co.uk)

Printed instructions are available free of charge by contacting [sales@dapol.co.uk](mailto:sales@dapol.co.uk)

But most of all. Enjoy.

# Checklist

- Real Grey 5
  - A5 (x2)
  - A7 (x2)
  - A8a (x2)
  - A8b (x2)
  - A10
  - A11
  - B5 (x2)
  - B6
  - C5a (x2)
  - C5b (x2)
  - C6
  - E8 (x2)
  - E9
  - F16 (x2)
- Real Grey 6
  - E1
  - E2
  - E3
  - E5a
  - E5b
  - E6a
  - E6b
  - F1
  - F2
  - F5a
  - F5b
  - F6a
  - F6b
  - F9a
  - F9b
  - F10a
  - F10b
  - F11 (x2)
  - F23
- Real Grey 7
  - B1
  - D1
- Real Grey 8
  - A1
- Real Grey 9
  - C1
- Red Brick 1
  - A18
- A19 (x2)
- B7
- C7 (x2)
- E13
- F24
- Rust Thin 1
  - Tiles A
  - Tiles B (x6)
  - Tiles C (x5)
  - Tiles D
  - Tiles T
- Rust Thin 2
  - Tiles A
  - Tiles B (x3)
  - Tiles C (x3)
  - Tiles E
  - Tiles F
  - Tiles G
  - Tiles H
  - Tiles I
  - Tiles J
  - Tiles T
- Rust Thin 3
  - Tiles K (x2)
  - Tiles L (x2)
  - Tiles M (x2)
  - Tiles N (x2)
  - Tiles O (x2)
  - Tiles P (x2)
  - Tiles Q (x2)
  - Tiles R (x2)
  - Tiles S (x2)
  - Tiles U (x2)
- Slate 19
  - H1
  - H2
- Slate 16
  - H3 (x2)
  - H8 (x2)
  - H10
  - H11 (x2)
- Slate 17
  - A9 (x2)
  - A15 (x2)
- A16 (x2)
- A17 (x2)
- E11
- F3
- F4
- F8 (x2)
- E11
- F14 (x2)
- F15 (x2)
- F17
- F18
- F19
- F20
- H5 (x2)
- H6
- H7
- Slate 18
  - E10
  - H4 (x2)
  - H5 (x2)
  - H9 (x2)
- Smoke 9
  - A12 (x2)
  - A13 (x2)
  - A14 (x2)
  - F12 (x4)
  - G1
  - G2
  - G3
  - G7 (x6)
- White 47
  - B2
  - D2
- White 48
  - A2
- White 49
  - C2
- White 50
  - F7a
  - F7b
  - F13a
  - F13b
  - F21
  - F22
- G6
- White 51
  - A4 (x2)
  - A6
  - B4
  - C4 (x2)
  - E7
- White 52
  - C3
- White 53
  - A3
- White 54
  - B3
  - D3
- White 55
  - G4
  - G5
- White 56
  - E4
  - E12
  - F21

1

A1 & A2

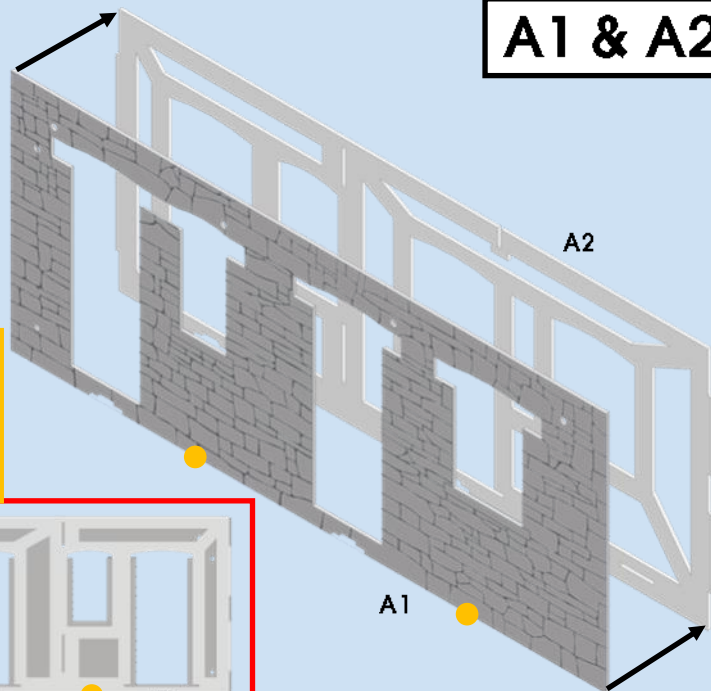

2

A3

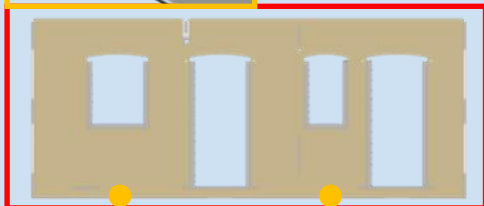
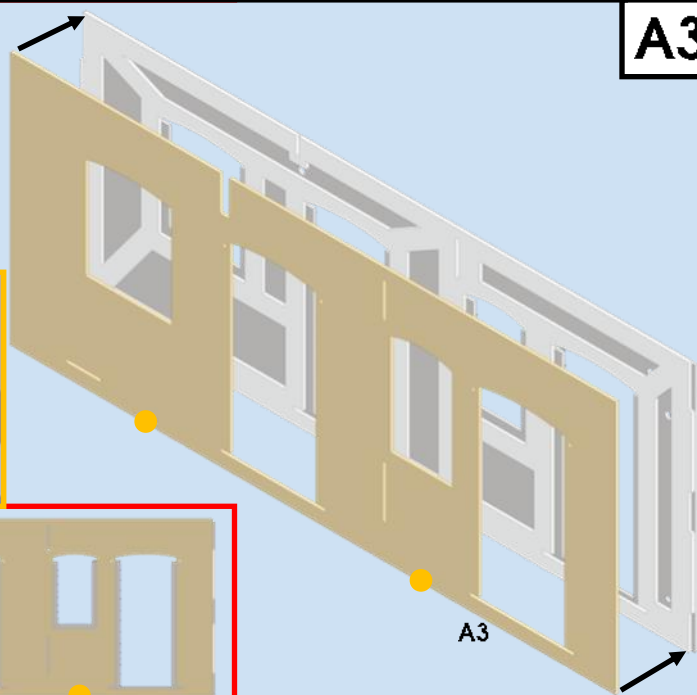

A3

**3**

**A18 & A19 (x2)**

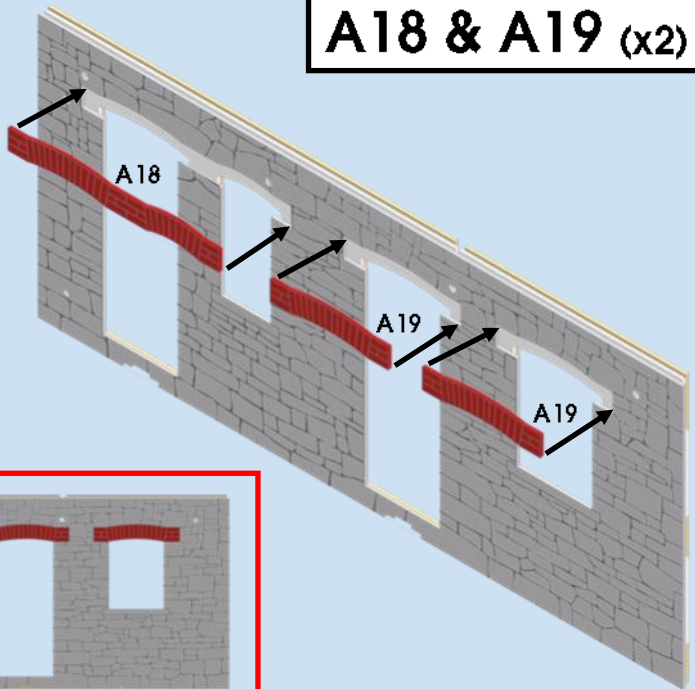

**!**

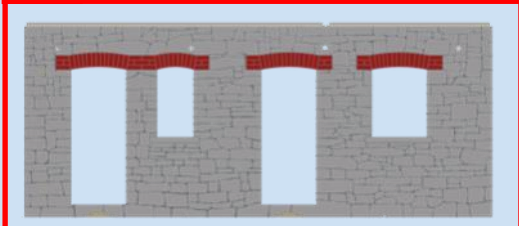

**4**

**A4 (Inc. Glazing) & A5 (x2)**

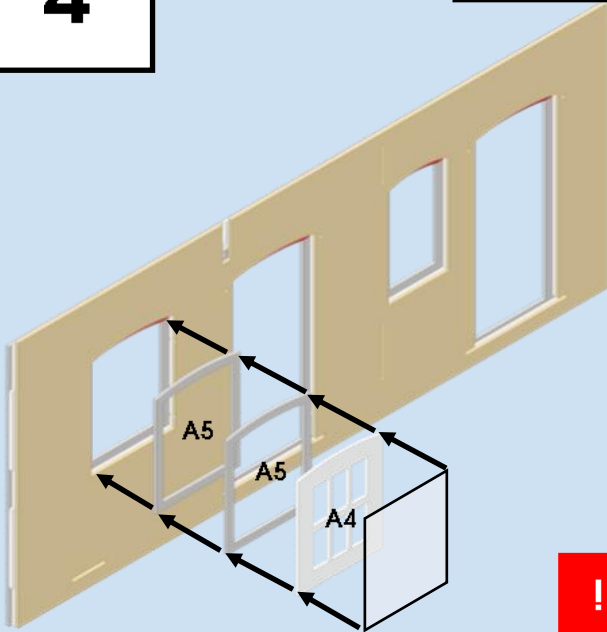

**!**

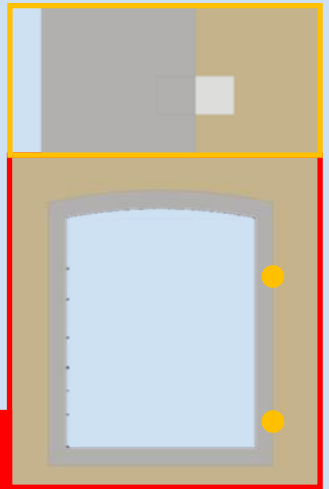

5

A6 (Inc. Glazing) & A7 (x2)

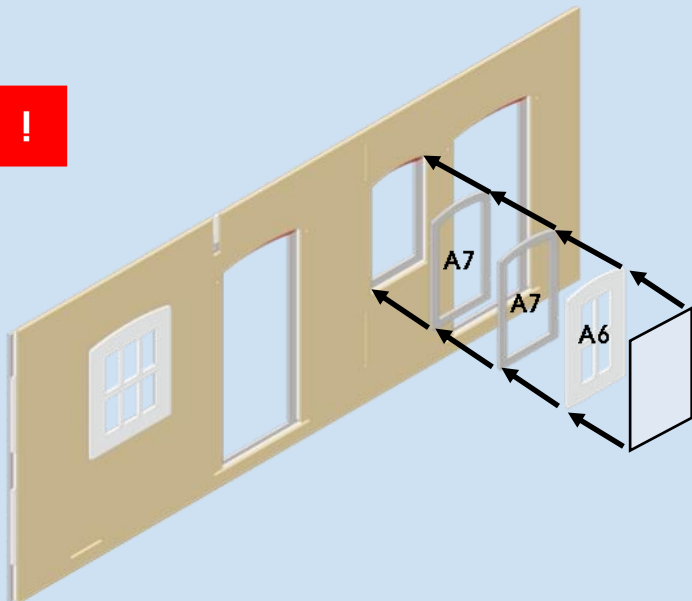
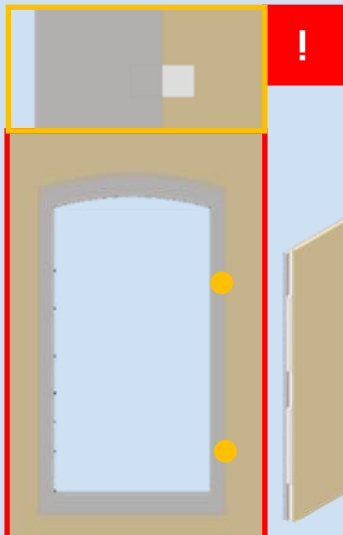

6

A9 & A8a (x2)

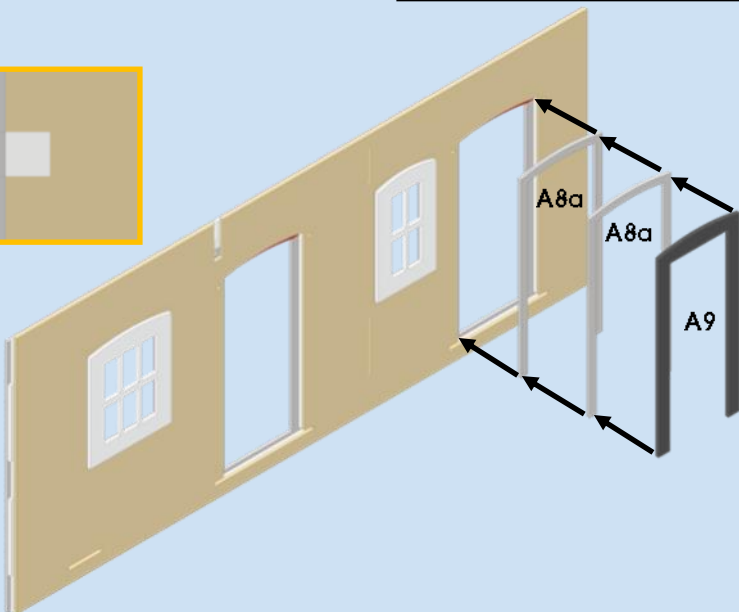
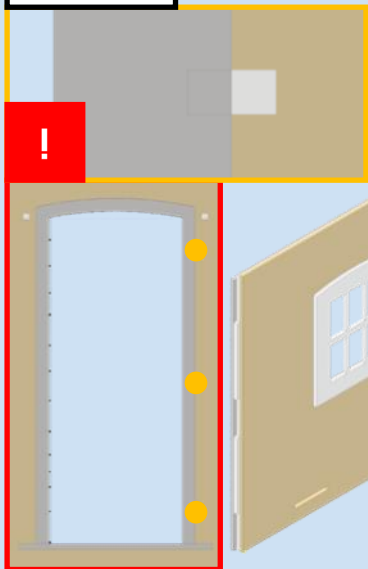

7

A9 & A8b(x2)

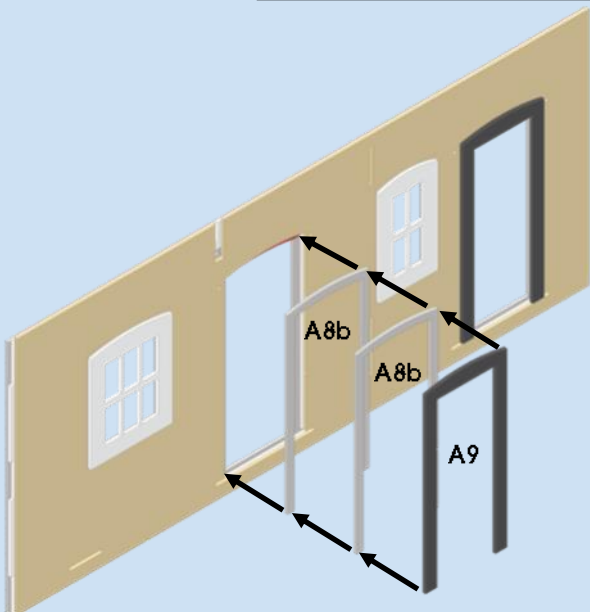
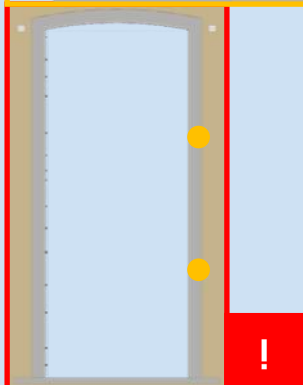

8

A10 & A11

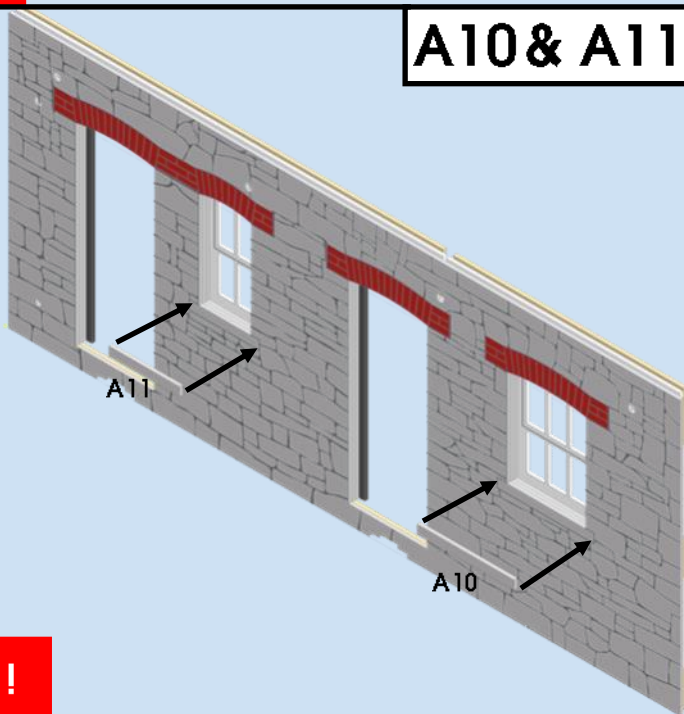
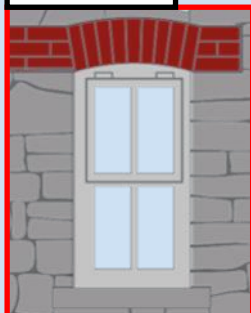

9

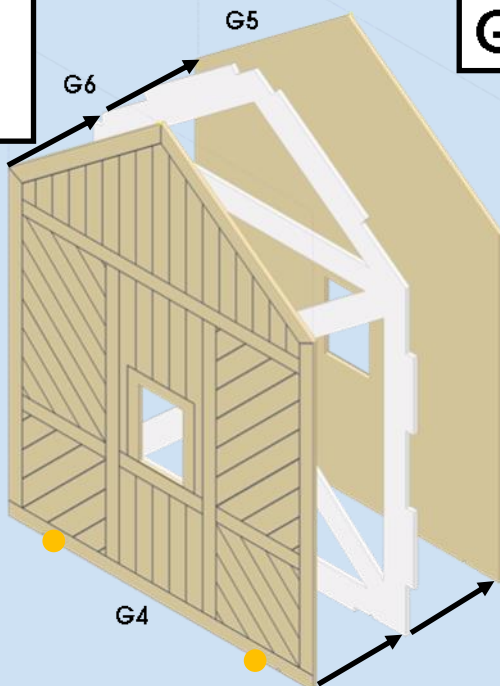

G4, G5 & G6

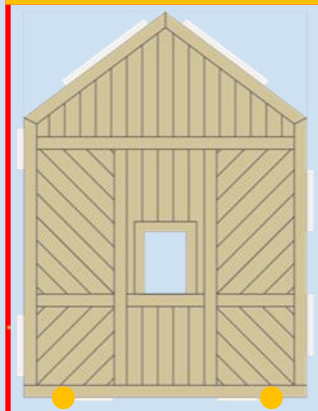

10

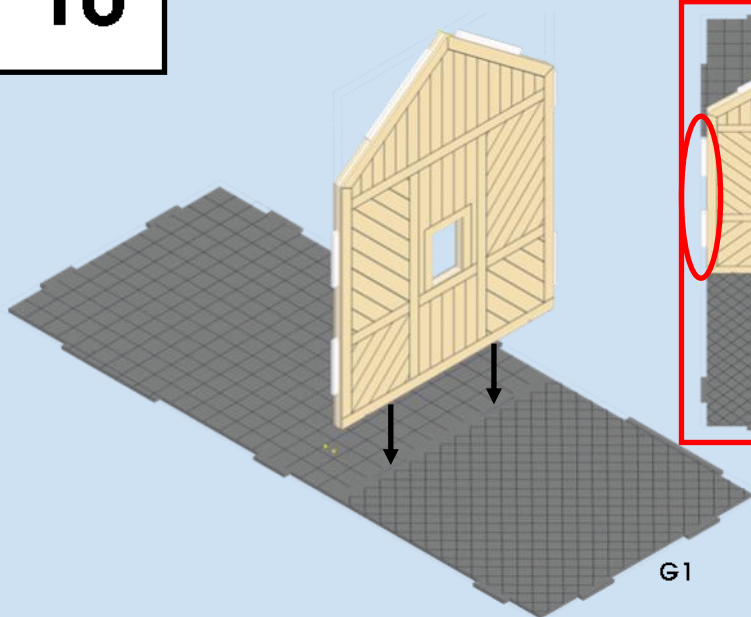

G1

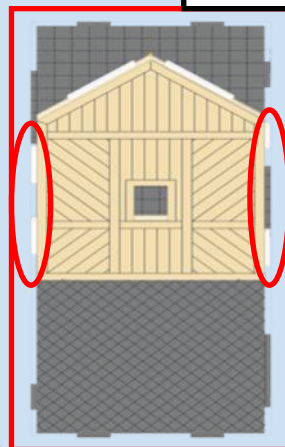

!



11

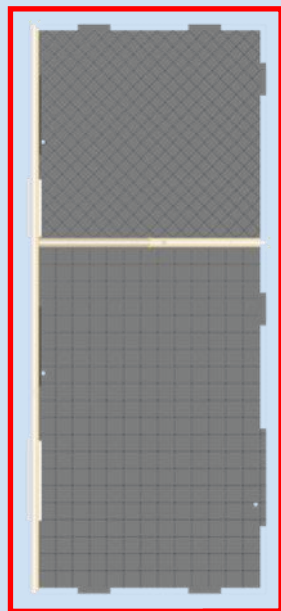
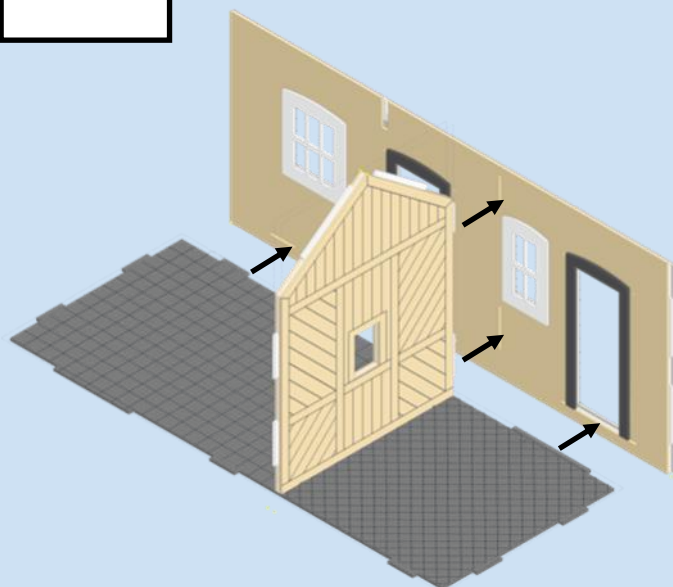

!

12

B1 & B2

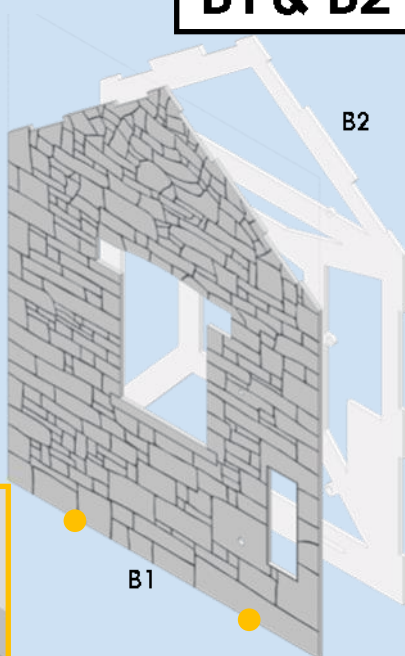
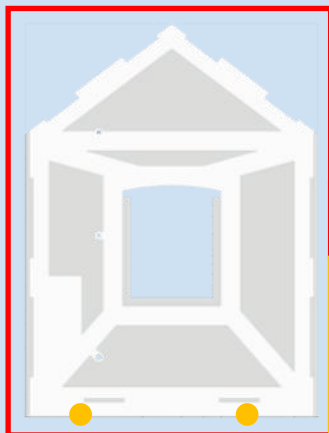

13

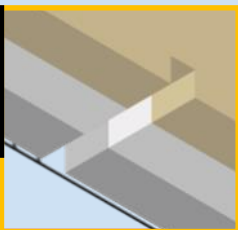

!

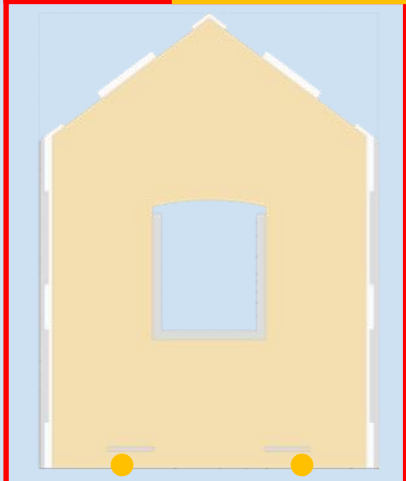

B3

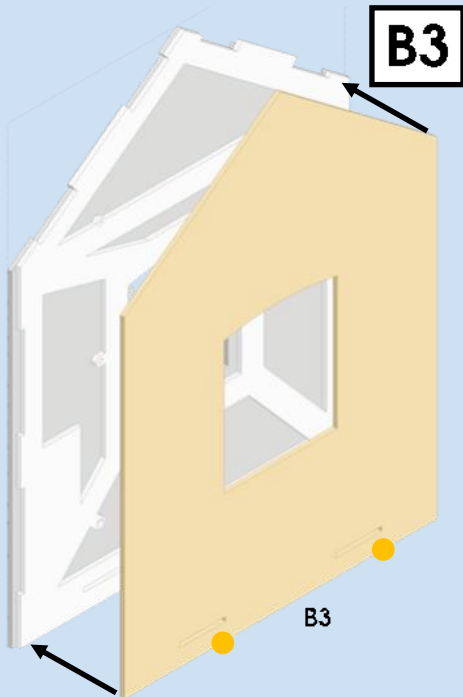

B3

14

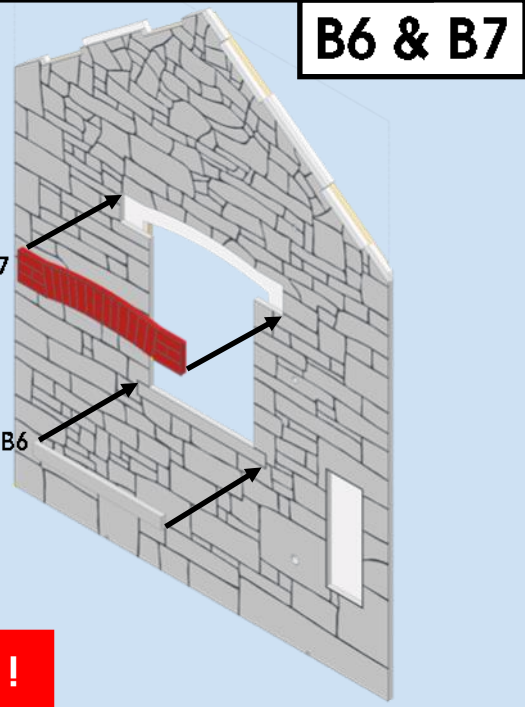
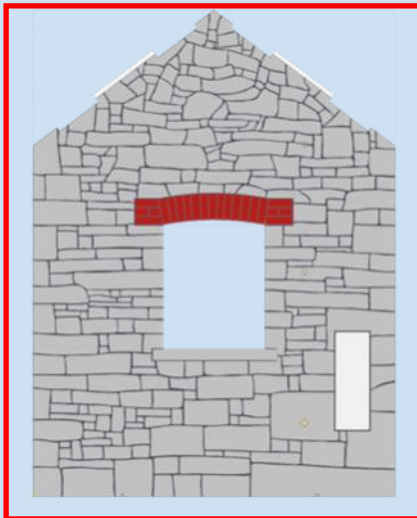

B6 & B7

B7

B6

!

15

B4(Inc. Glazing) & B5(x2)

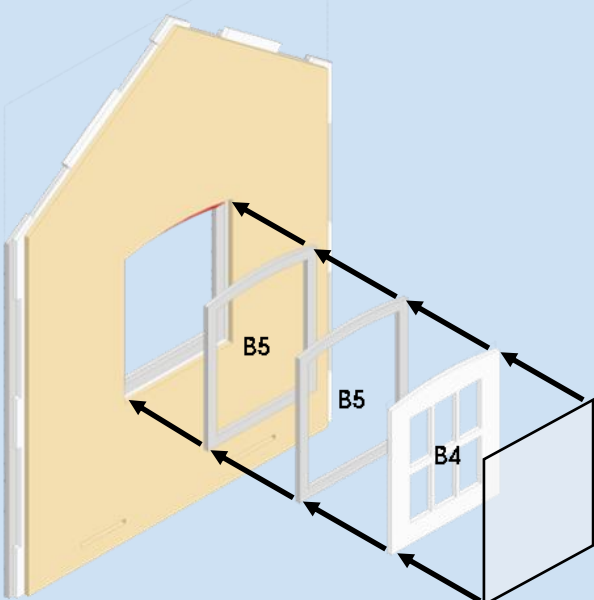
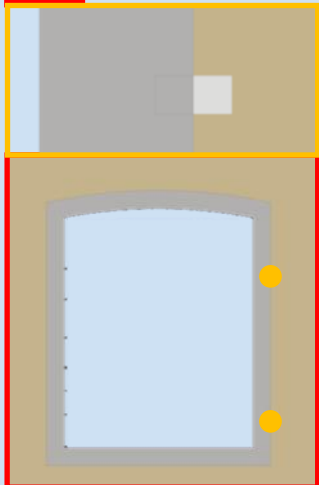

16

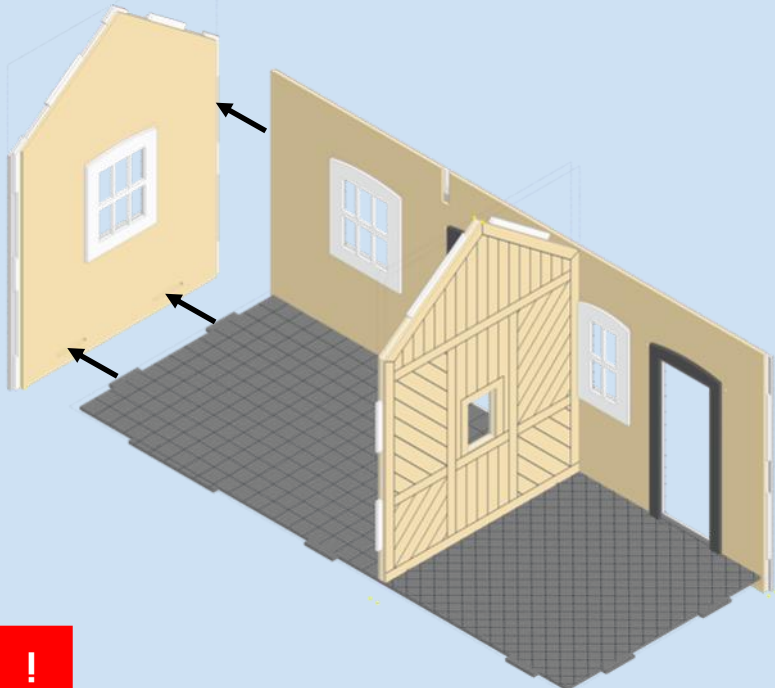
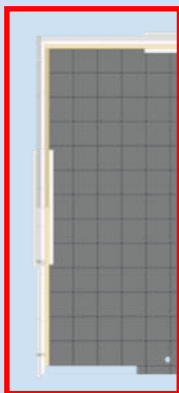

17

A15(Inc. Glazing)(x2) & A16(x2)

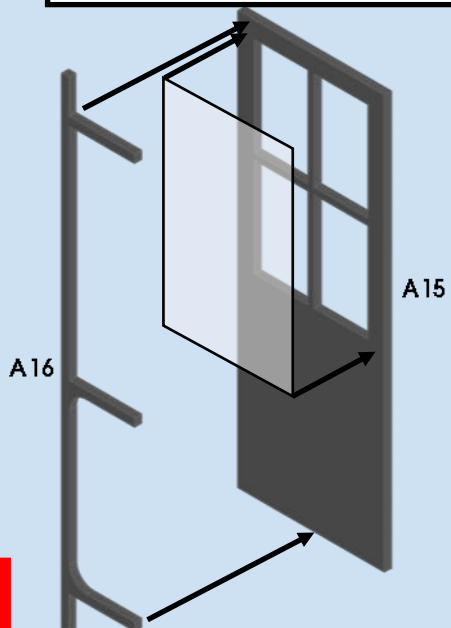

18

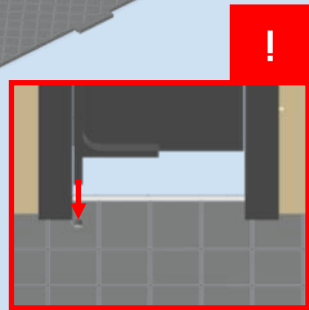
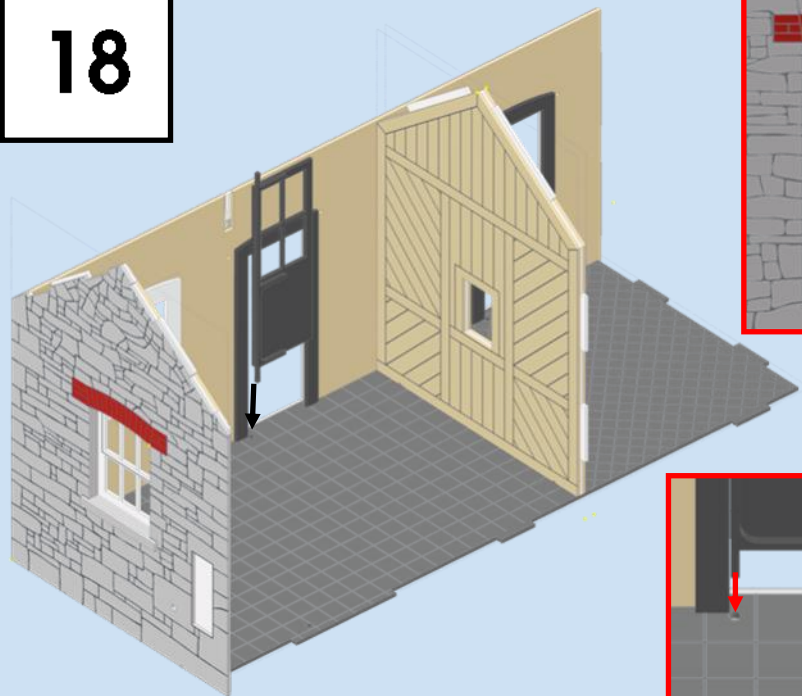

19

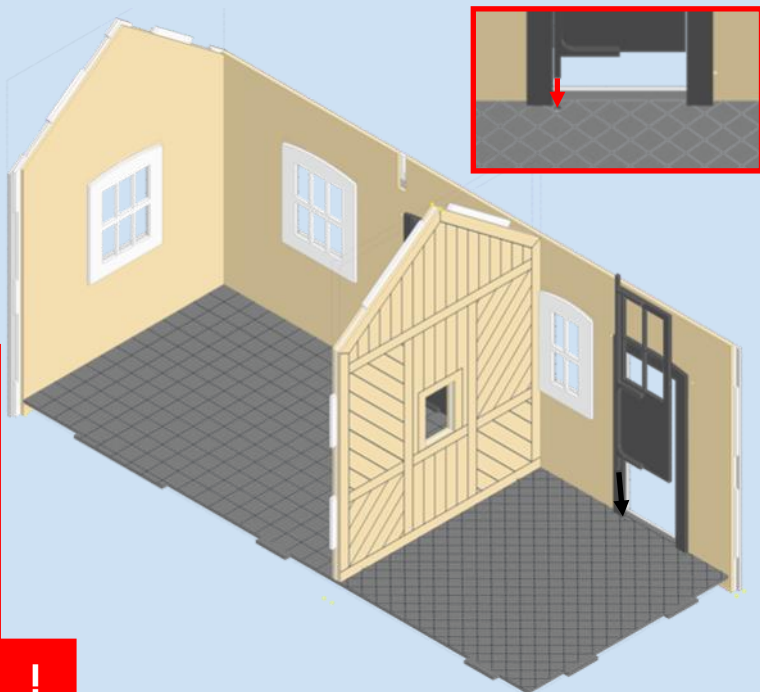

20

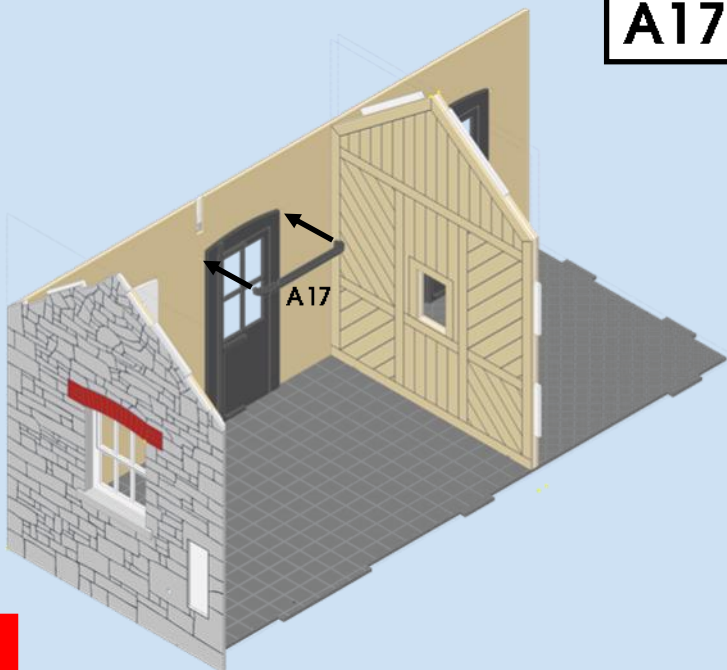

A17

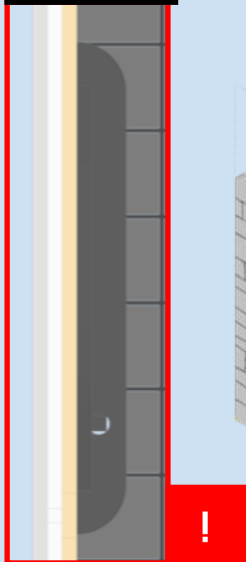

21

A17

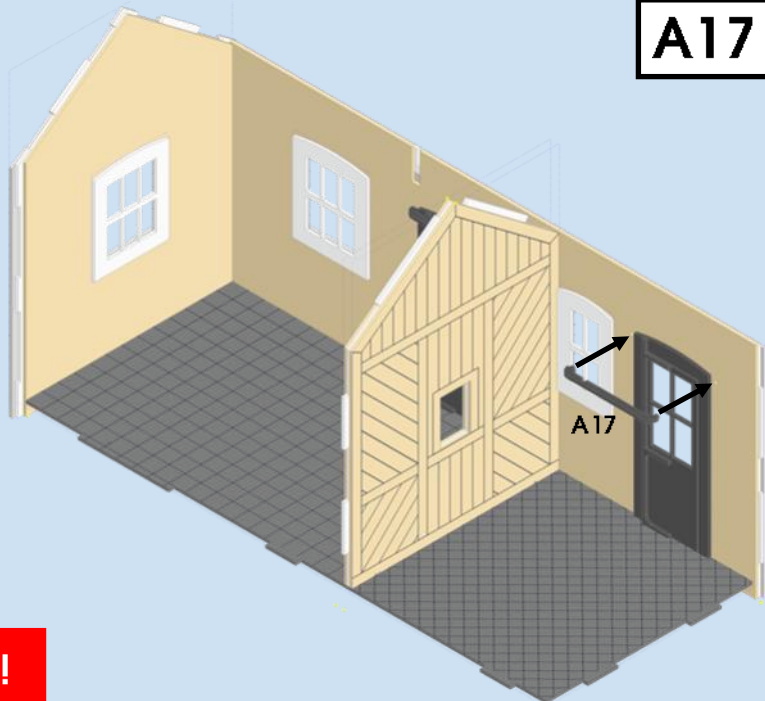

22

D1 & D2

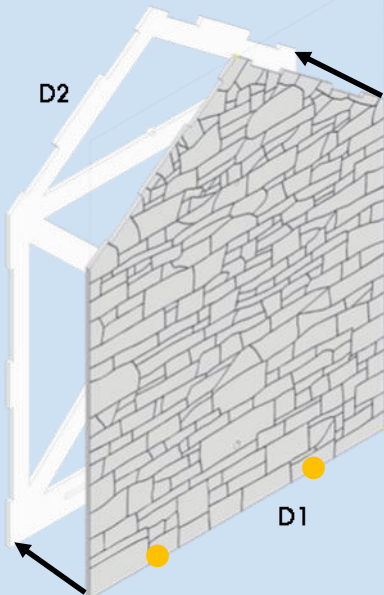
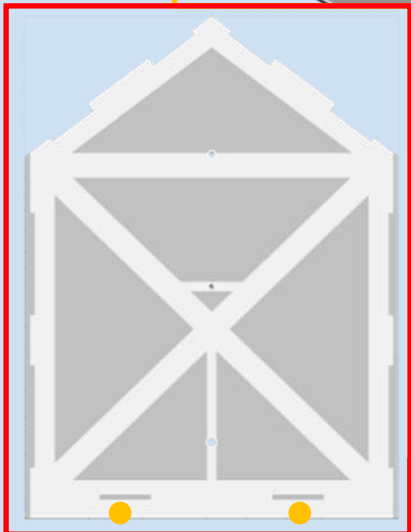

# 23

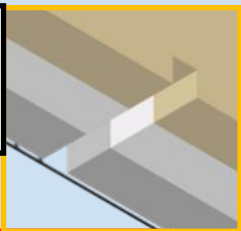

!



# D3

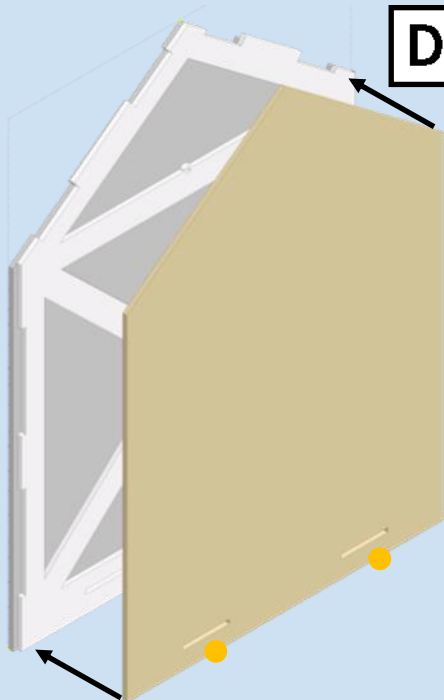

# 24

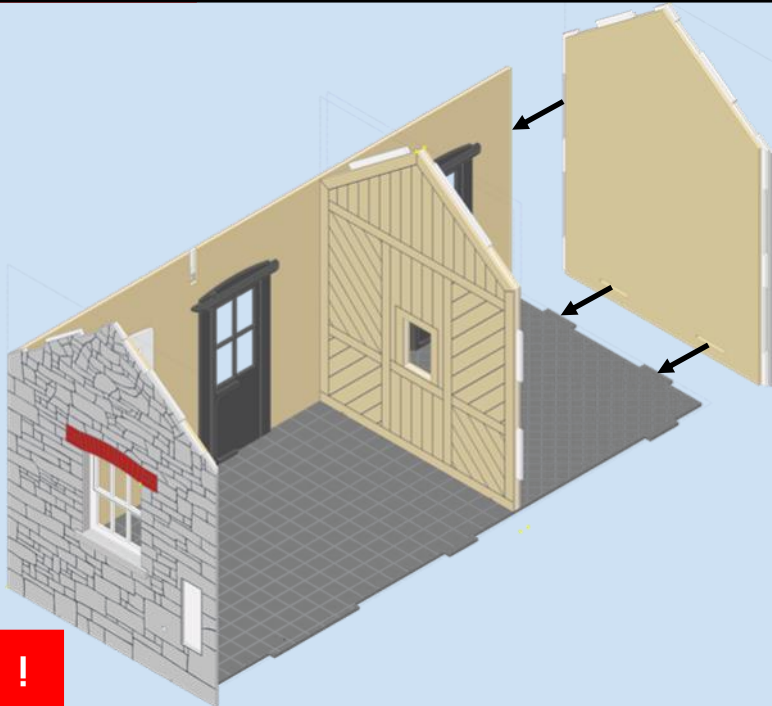

!

25

C1 & C2

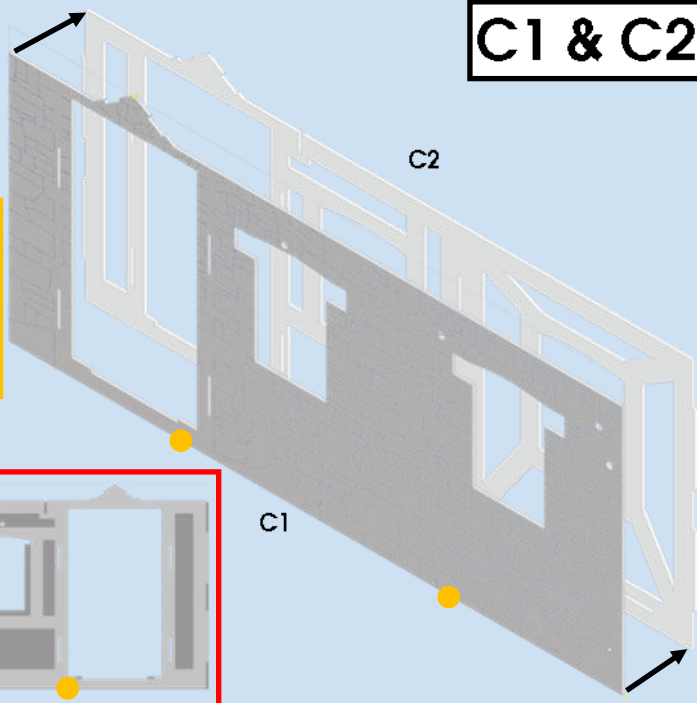
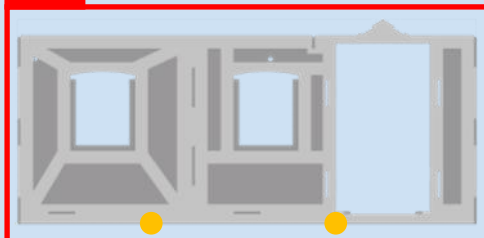

26

C3

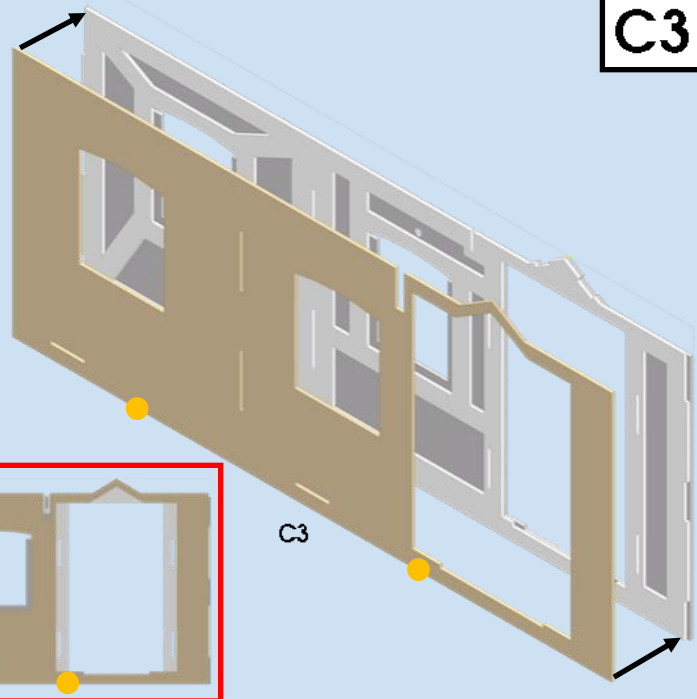
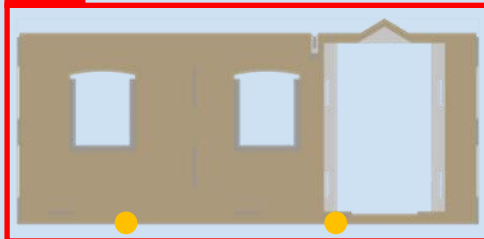



27

C6, C7(x2) & E9

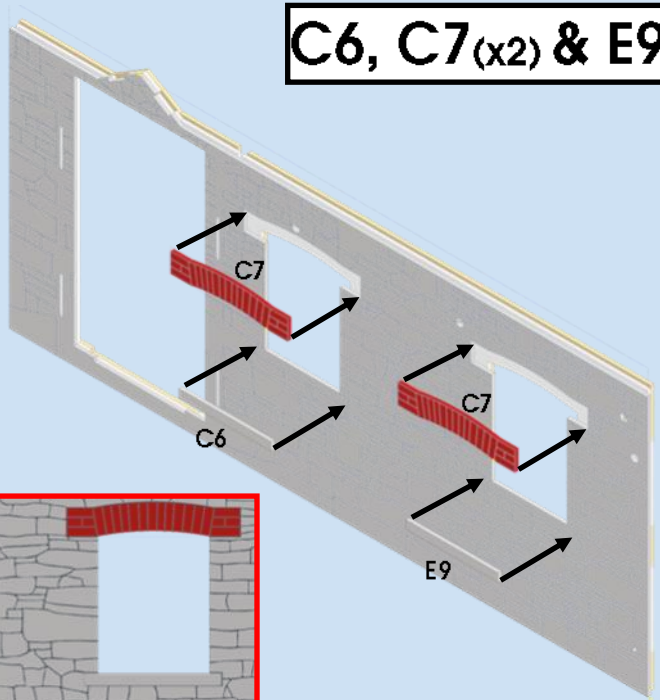

28

C4(Inc. Glazing) & C5a(x2)

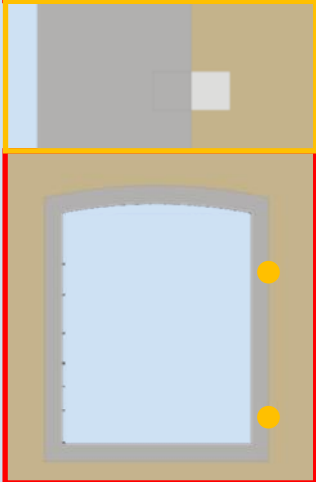
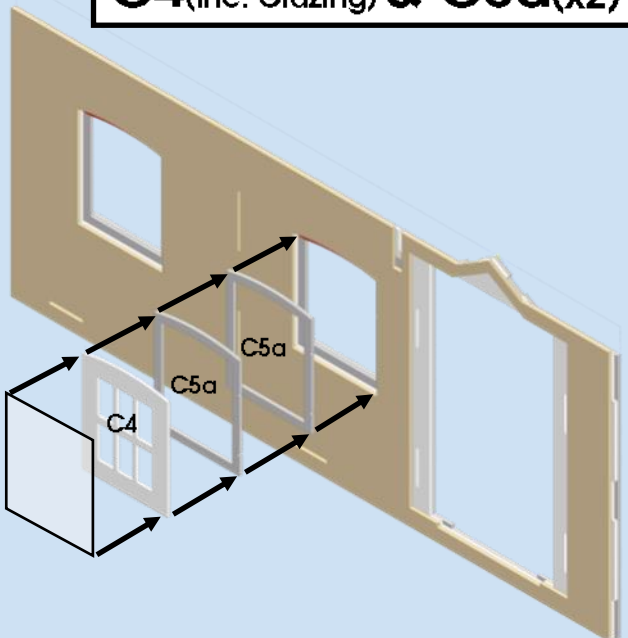

**29**

**C4(Inc. Glazing) & C5b(x2)**

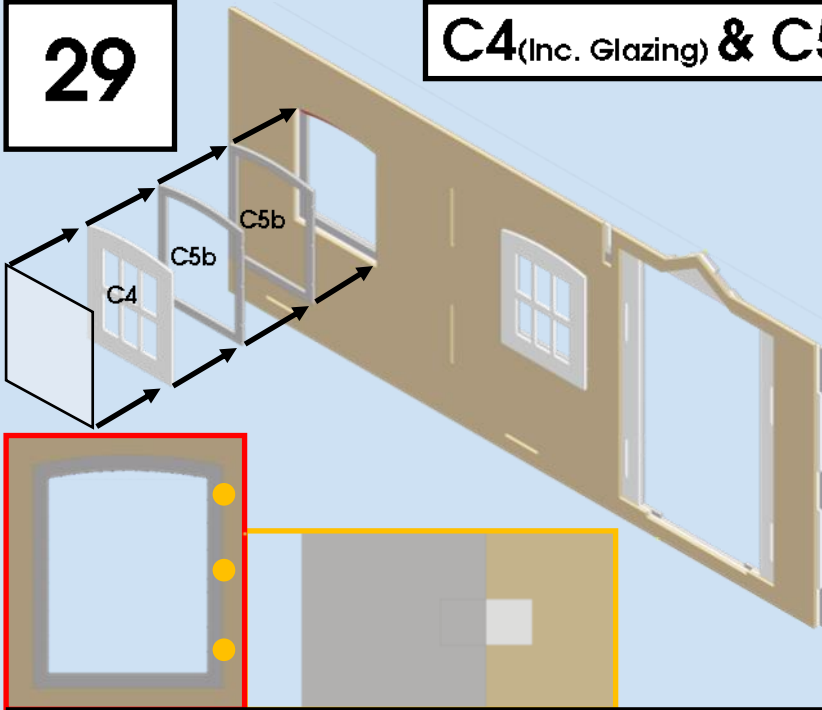

**Early Porch**

**For Later Porch, skip to step 60**

**30**

**F22 & F23**

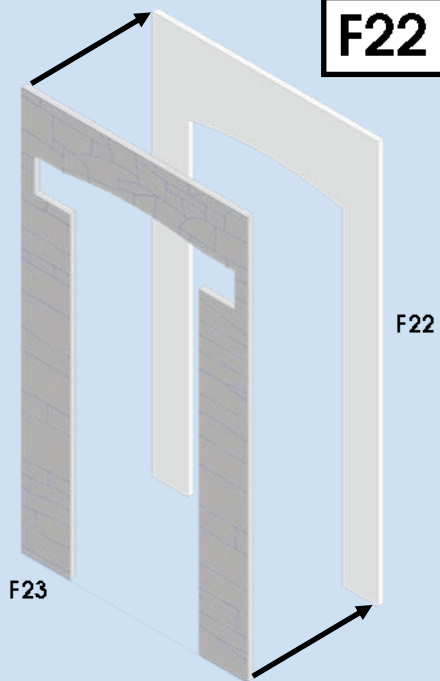
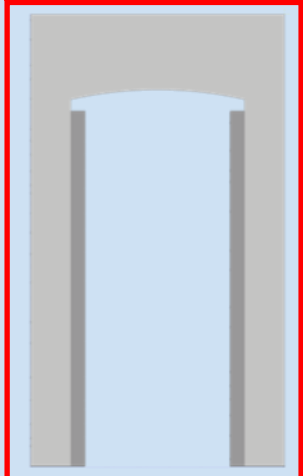

**31**

**F21**

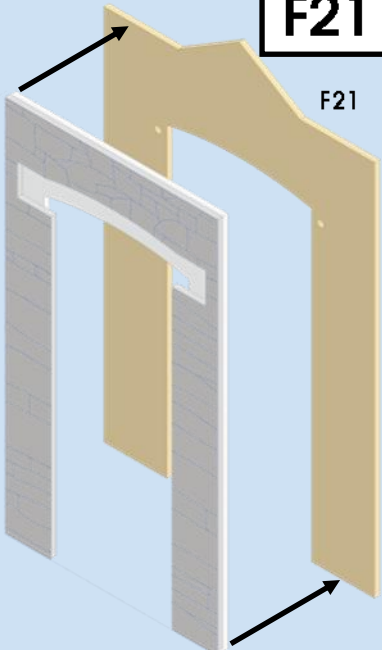
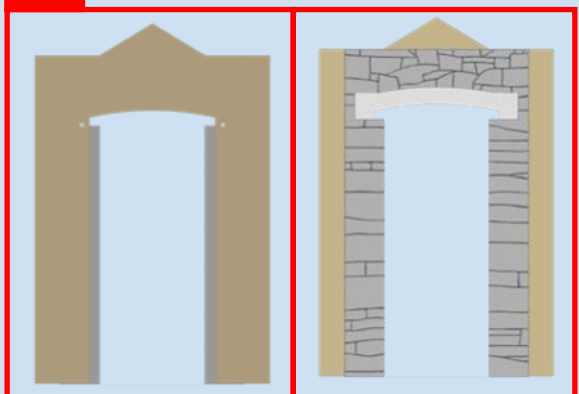

32

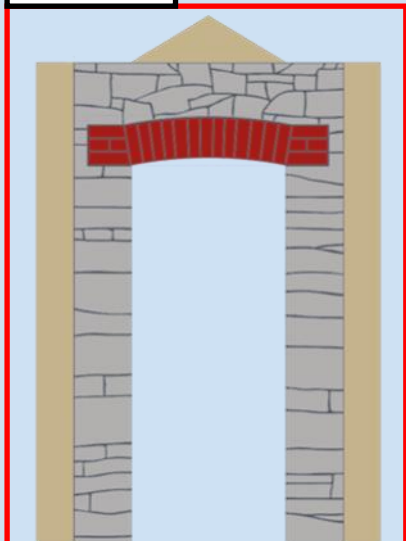

F24

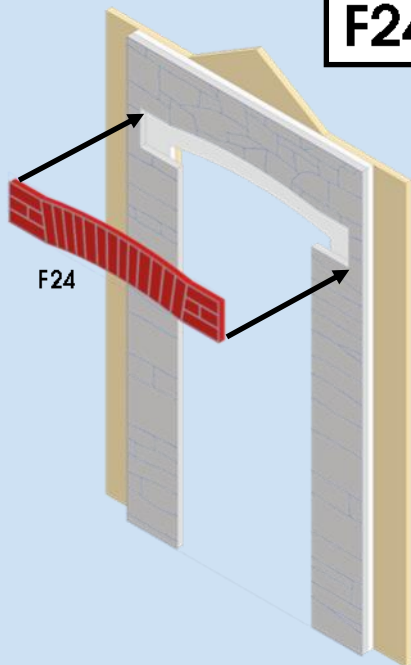

33

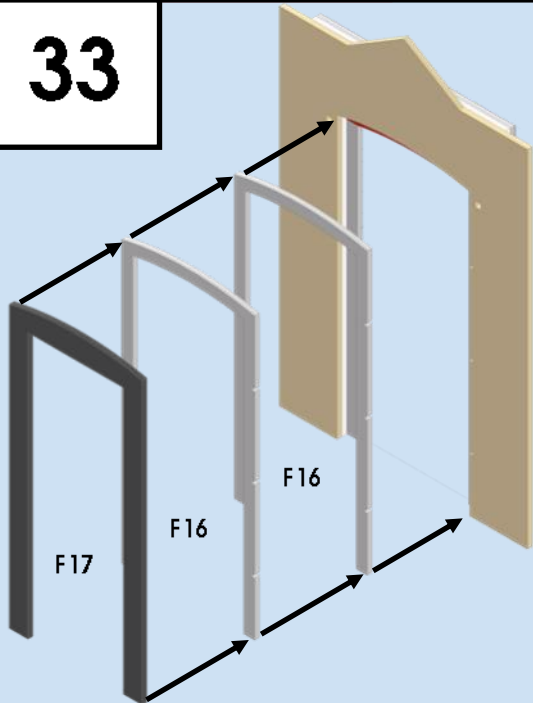

F16(x2) & F17

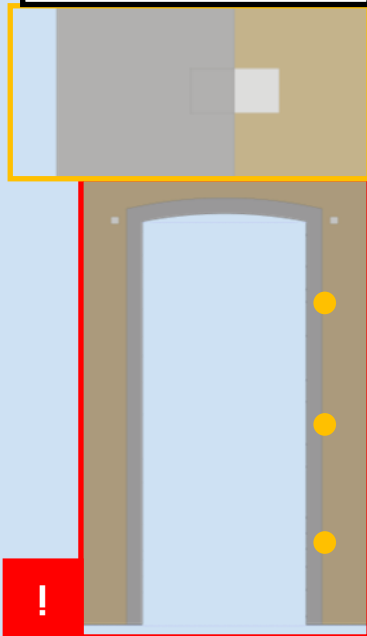

34

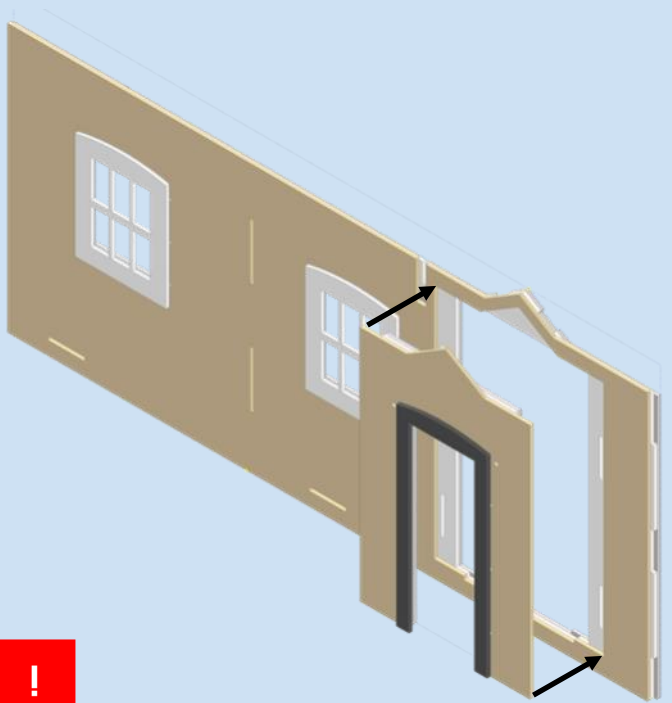
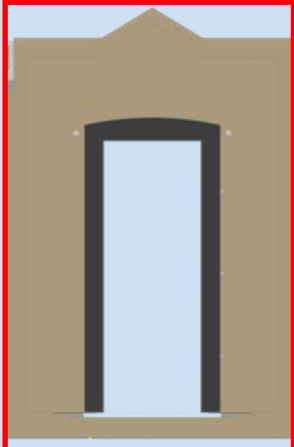

35

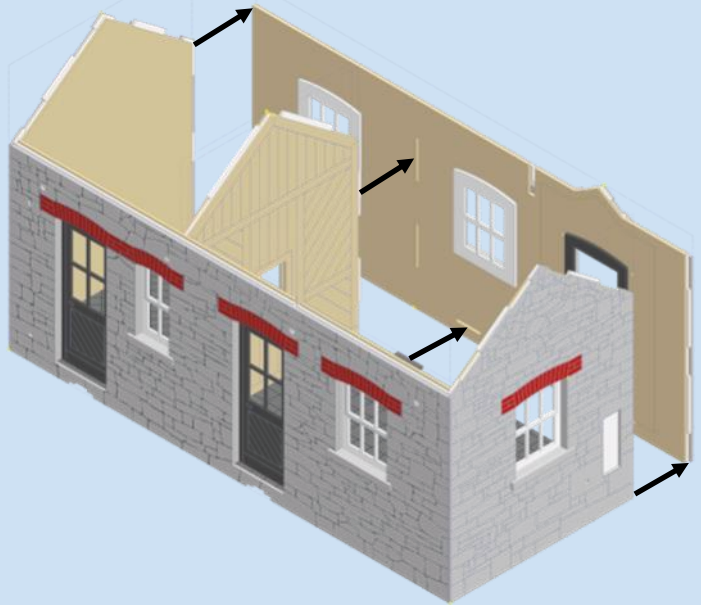
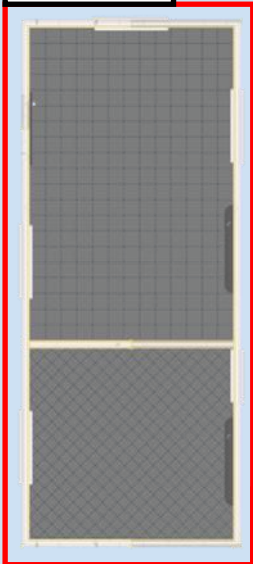

**36**

**F18 (Inc. Glazing) & F19**

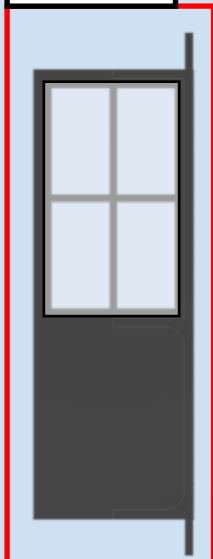

F18

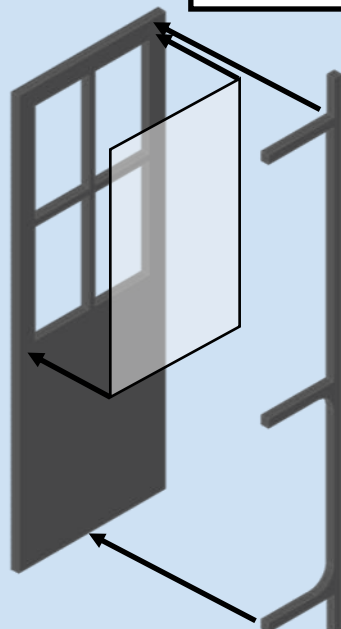

F19

**37**

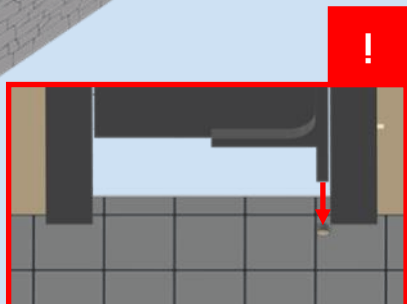
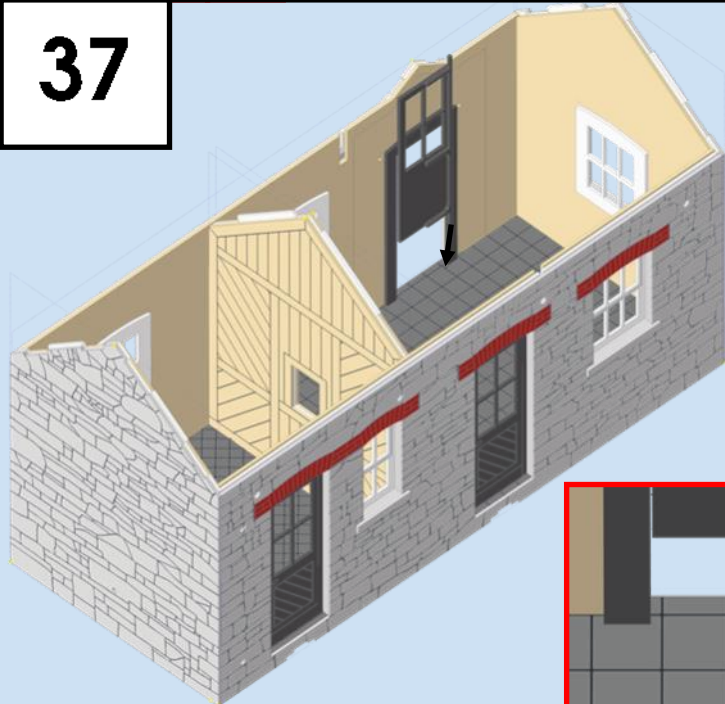

!

38

F20

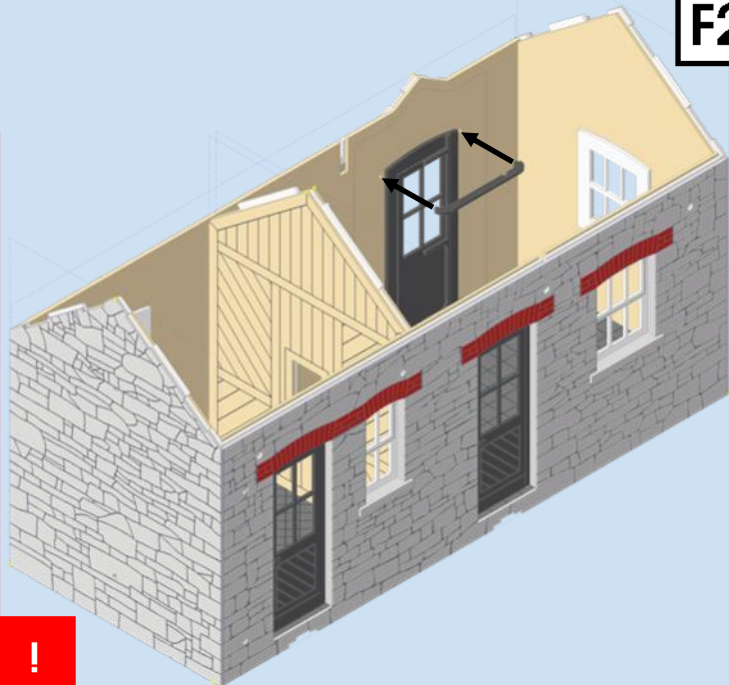
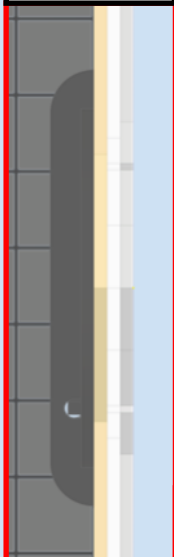

39

F1, F5a & F6a

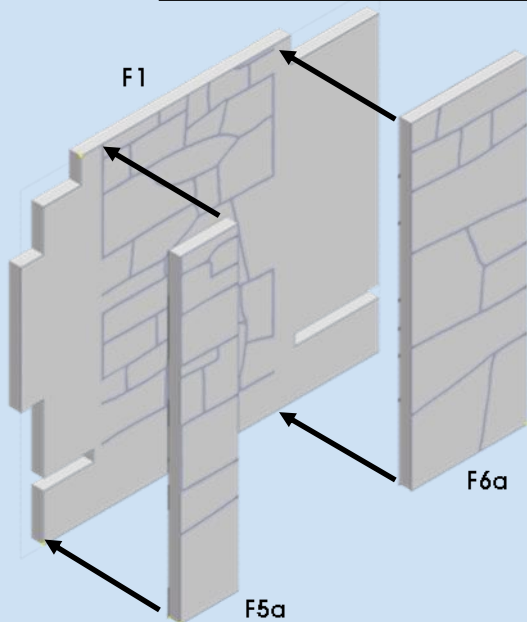
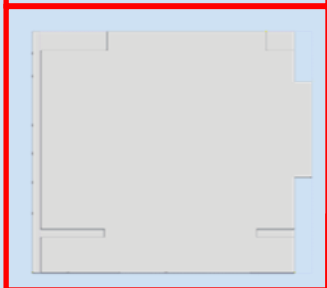
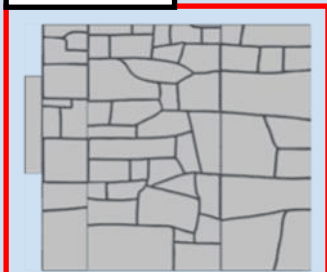

40

F7a, F8, F13a & F14

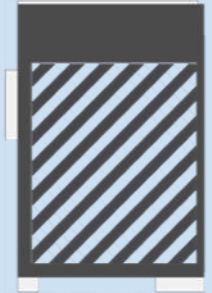
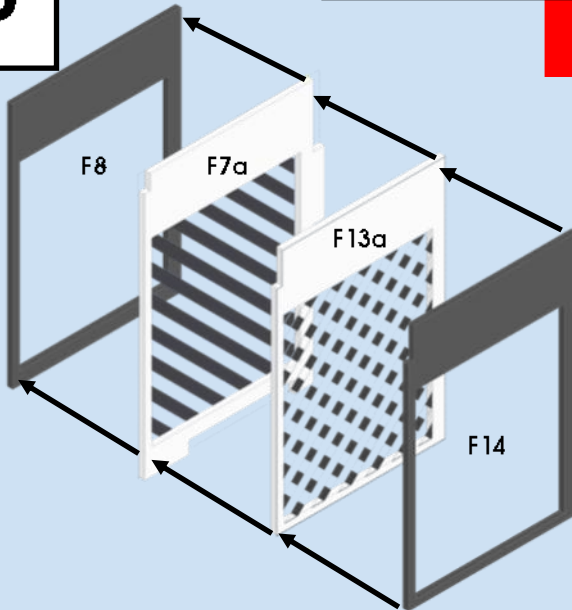

41

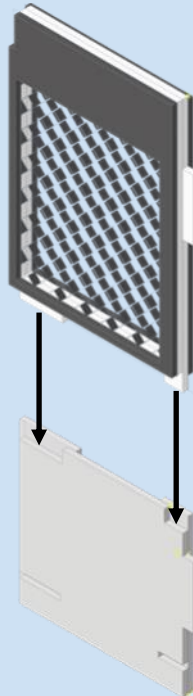
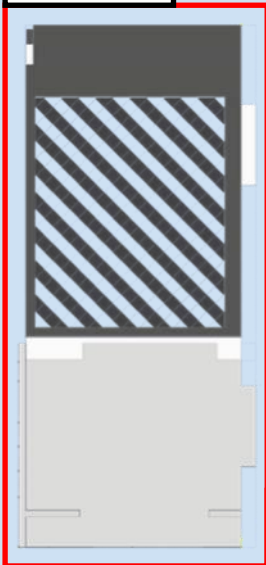



42

G3

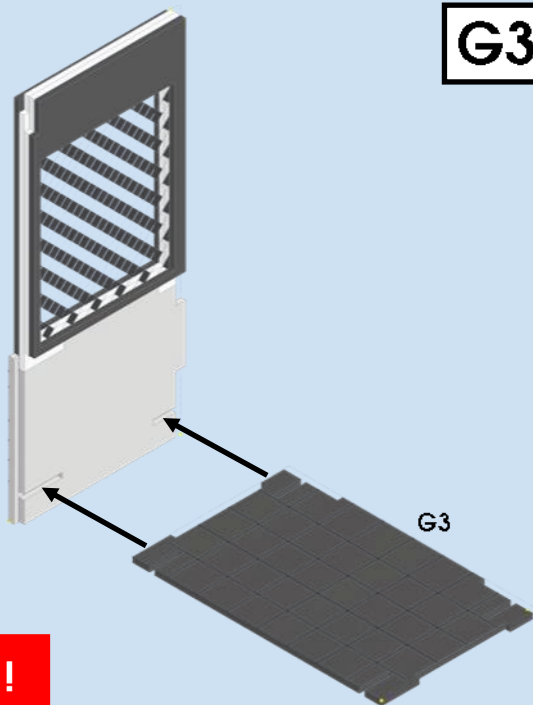
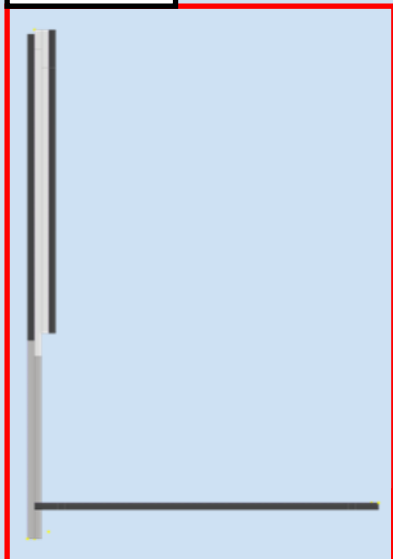

43

F10a

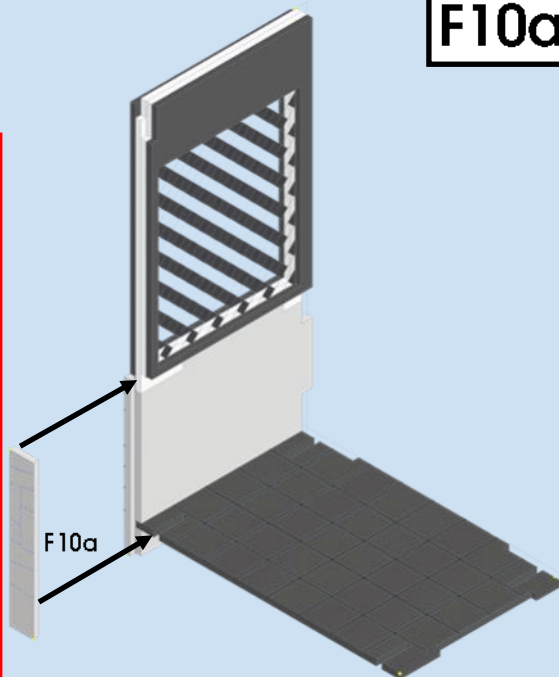
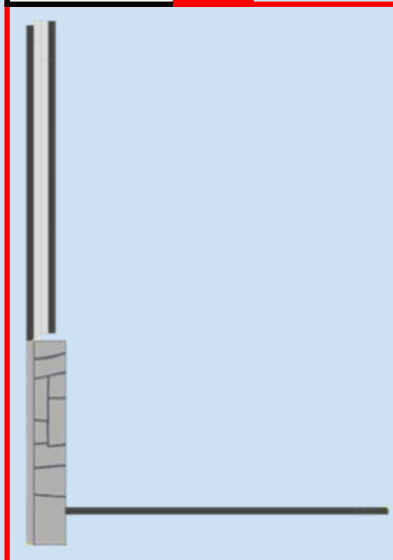

44



F9a

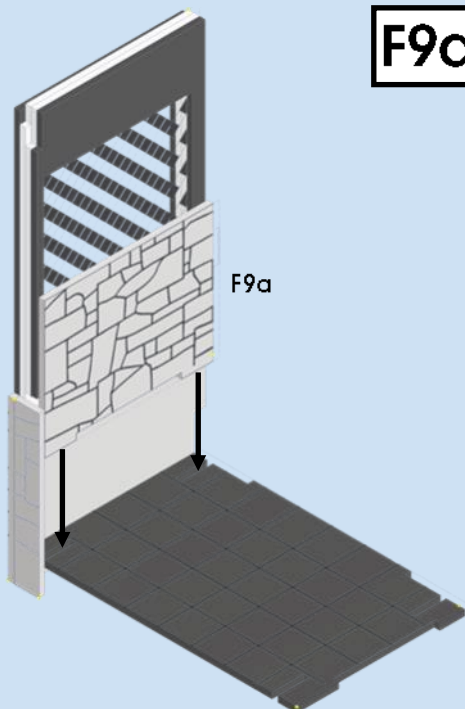

45

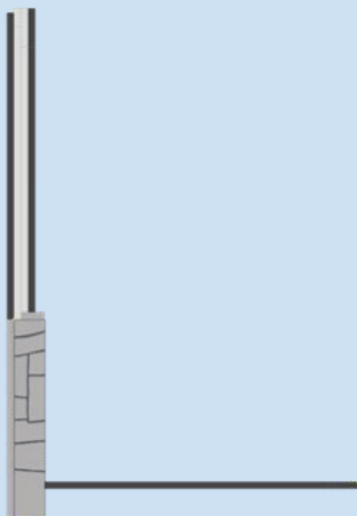

F11

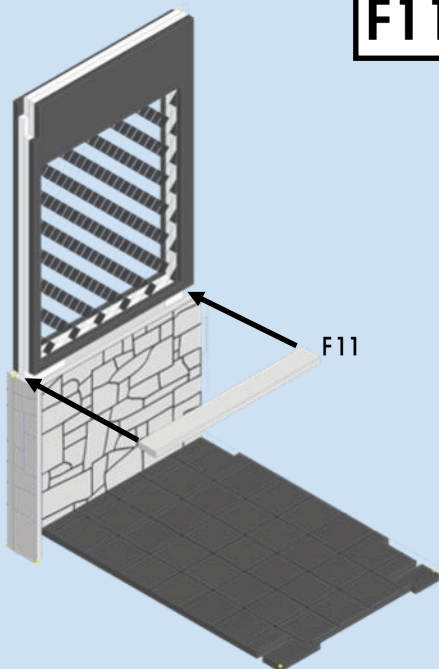

46

F15

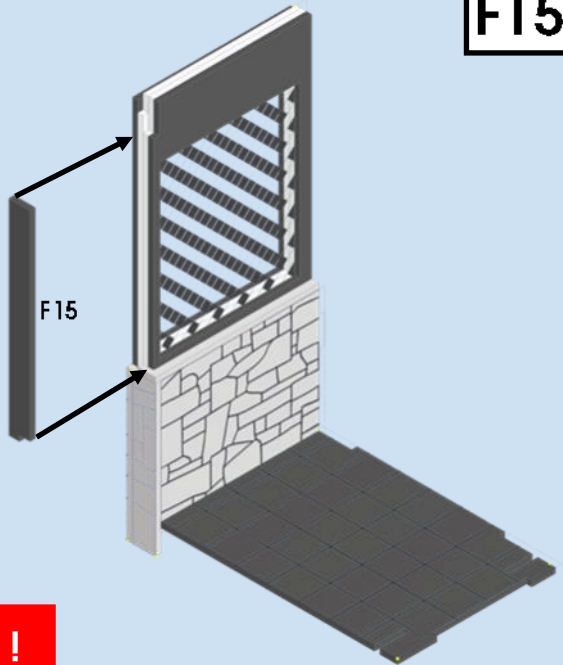
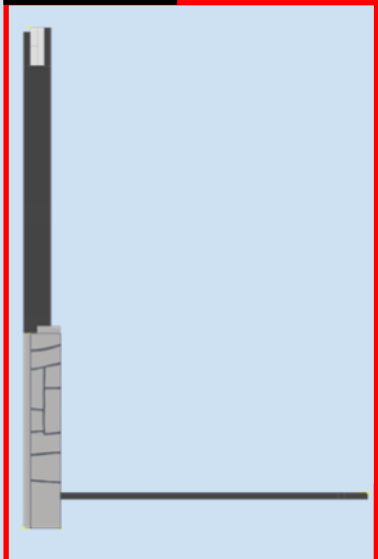

47

F2, F5b & F6b

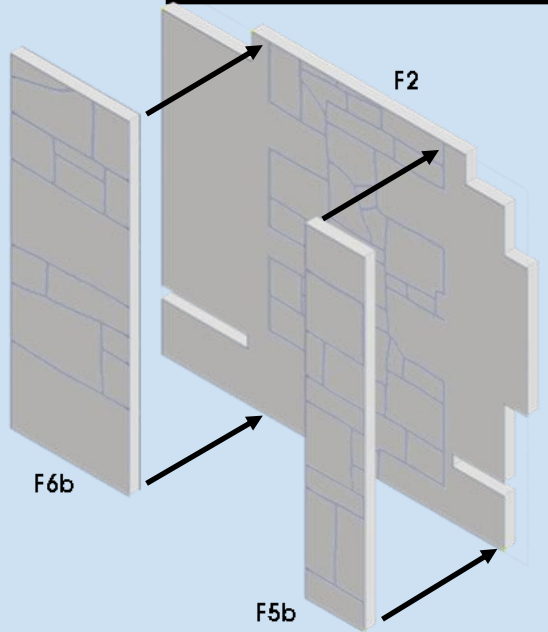
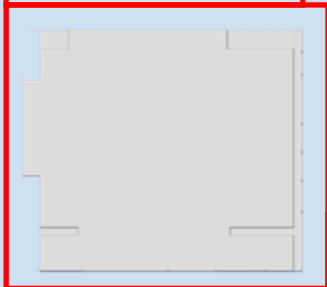

48

F7b, F8, F13b & F14

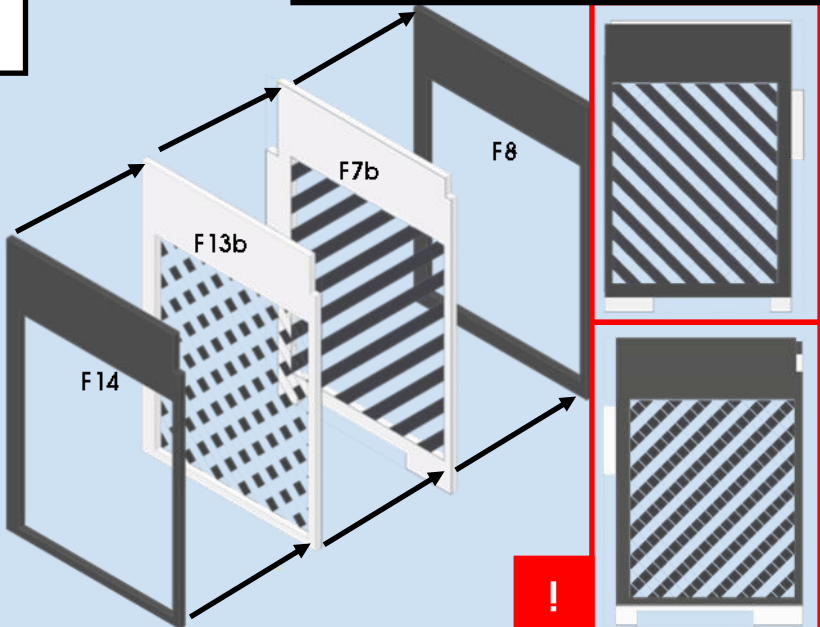

49

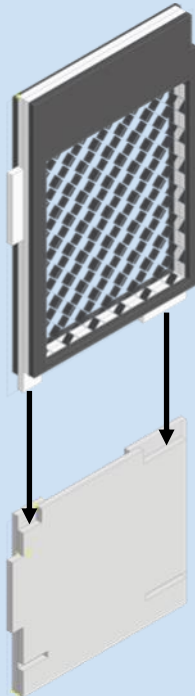
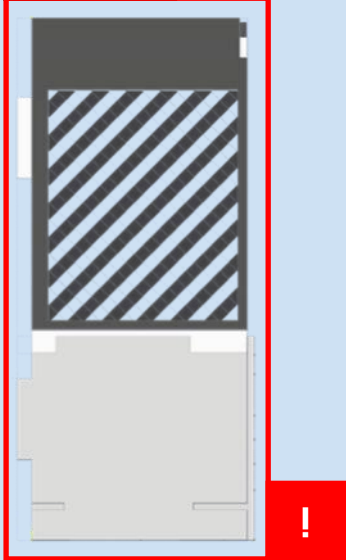

50

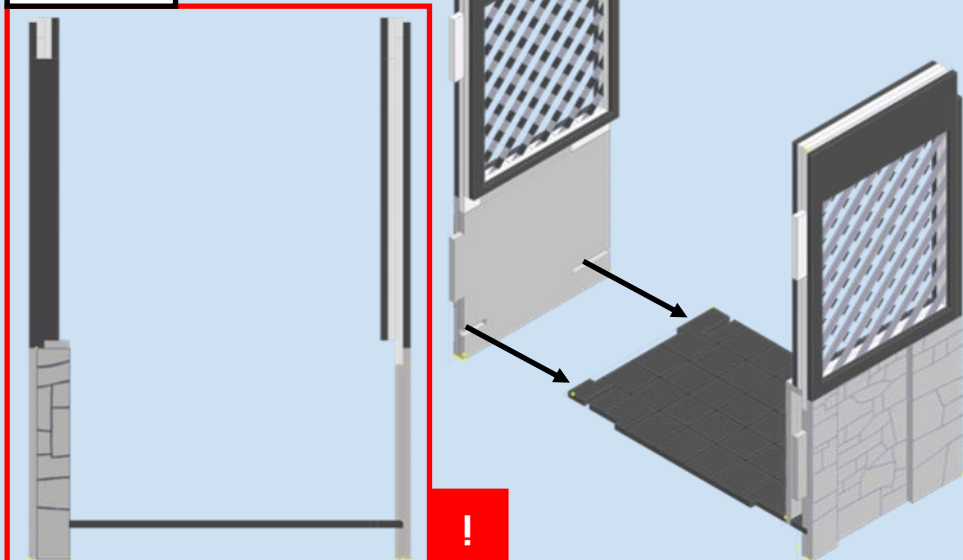

51

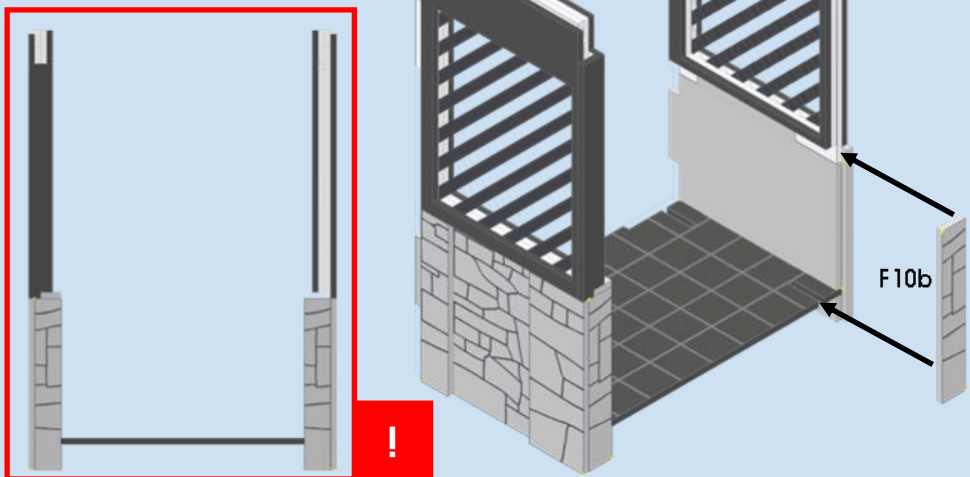

52

F9b

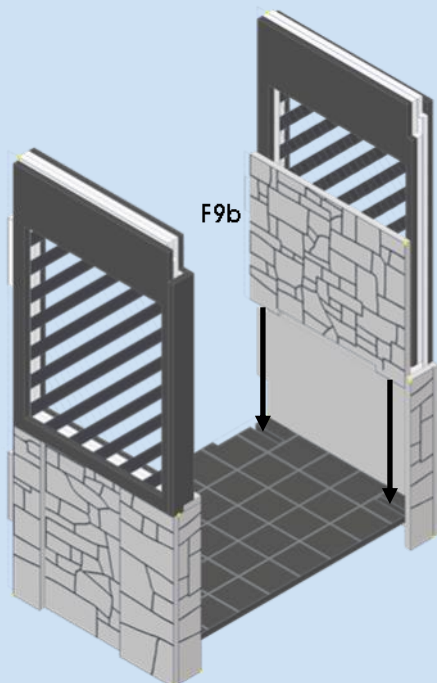

53

F11

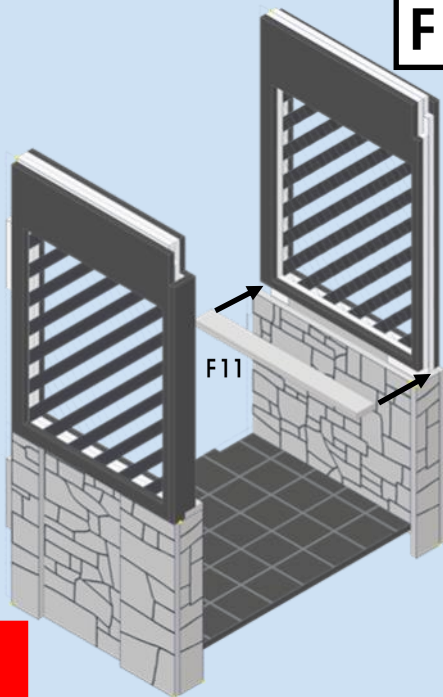
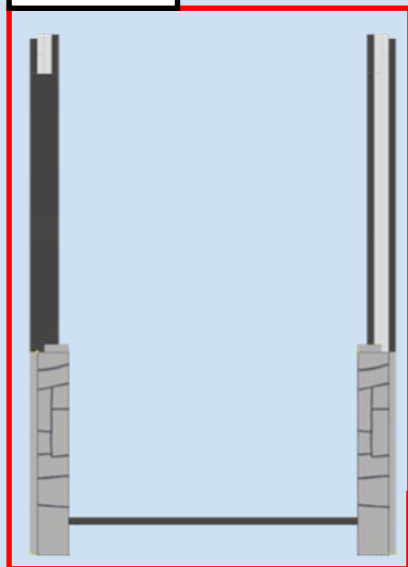

54

F15

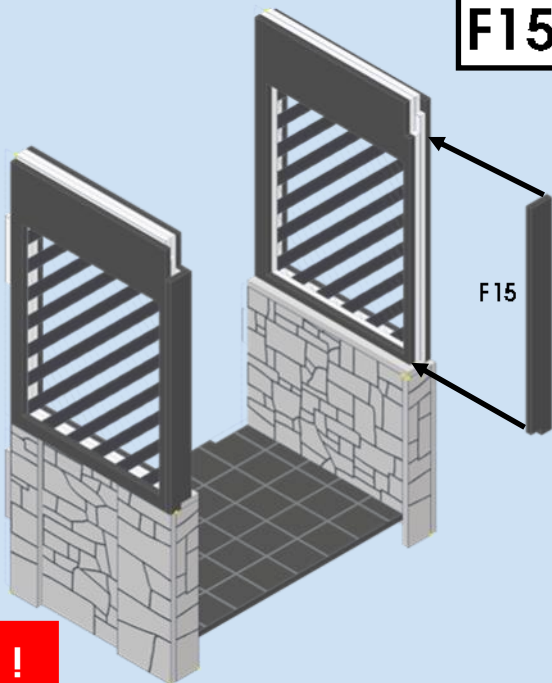
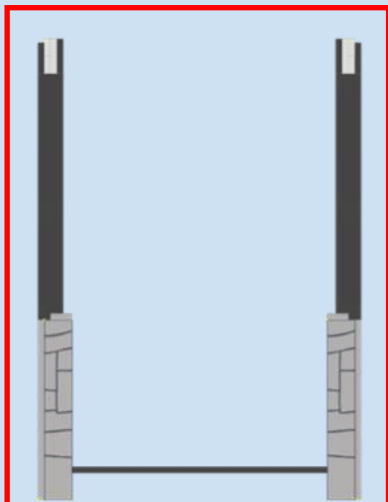

55

F12(x2)

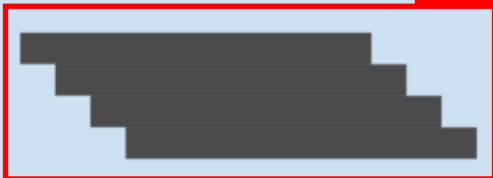
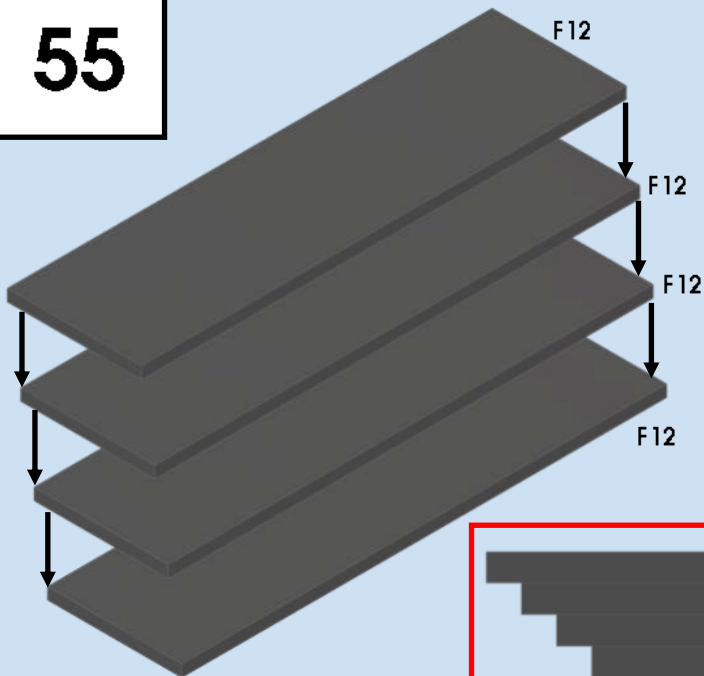

56

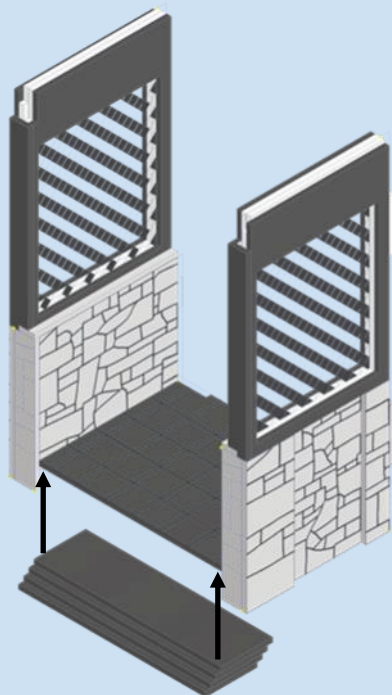
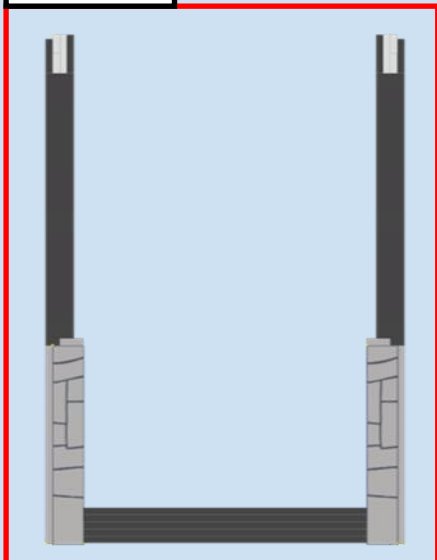

57

E11, F3 & F4

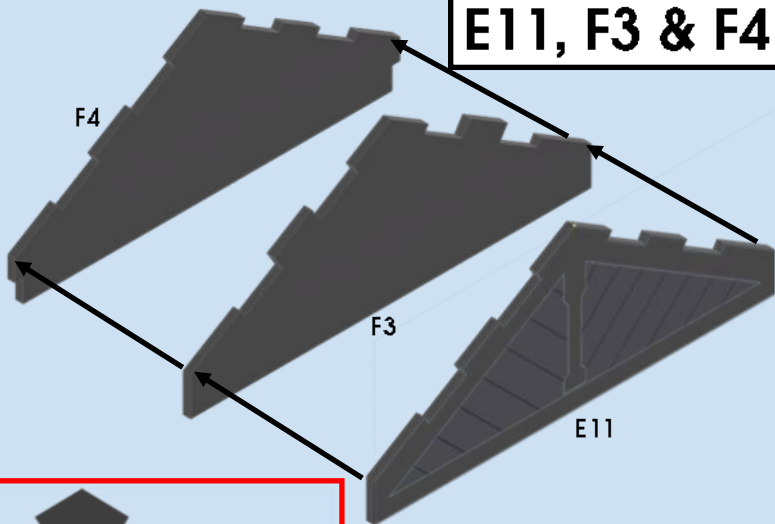



58

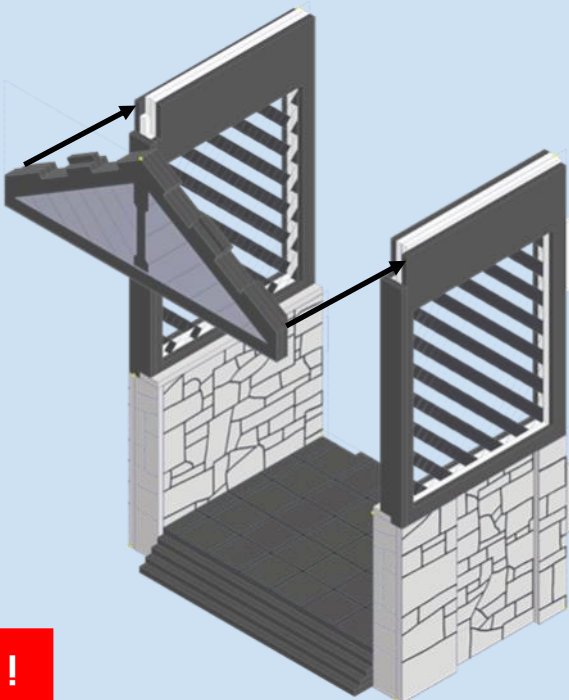
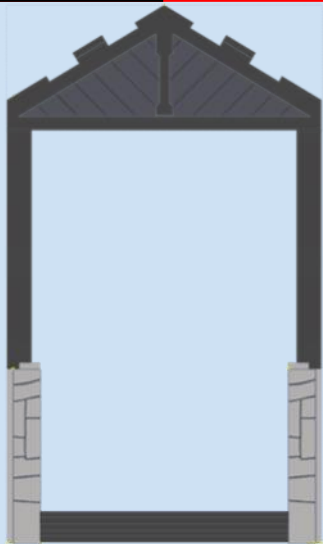

59

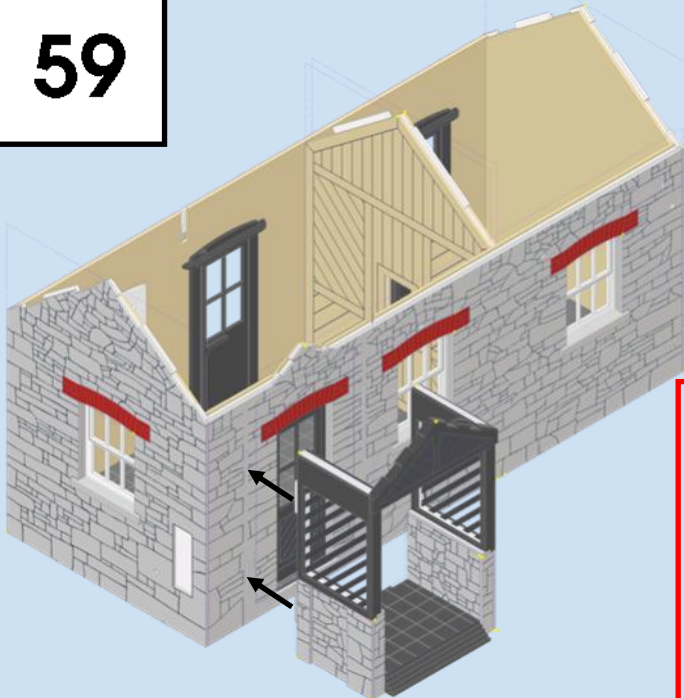

## Later Porch

For the roof, skip to step 72

60

E12

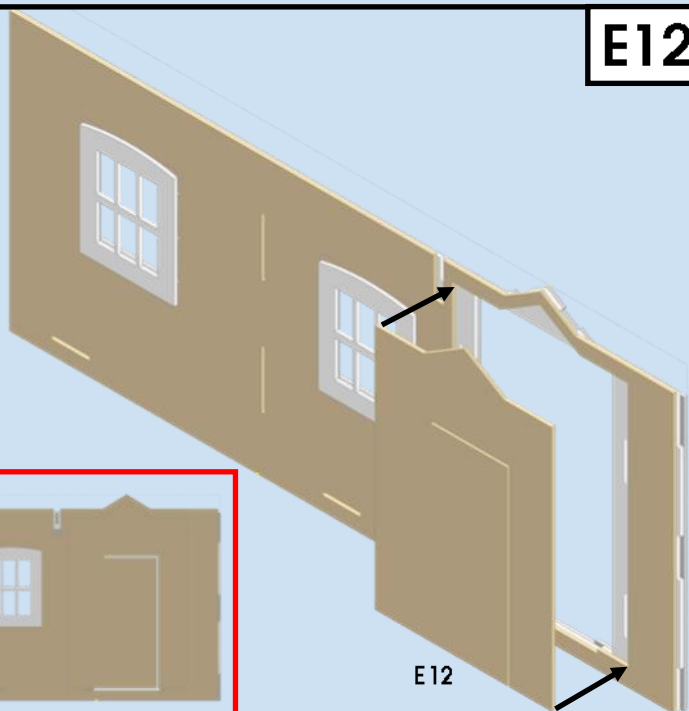

!



E12

61

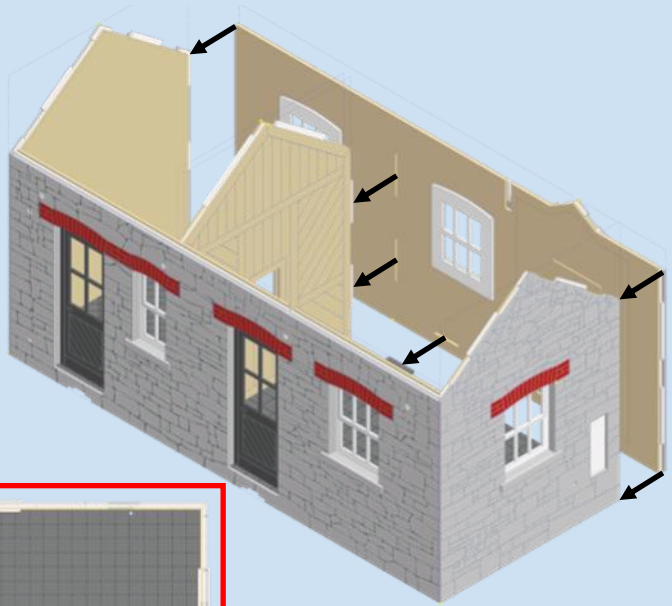

62

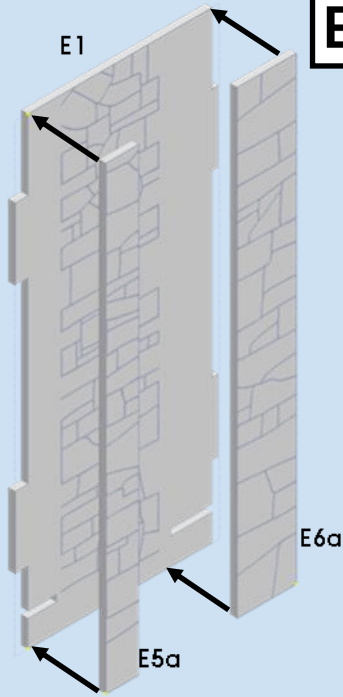
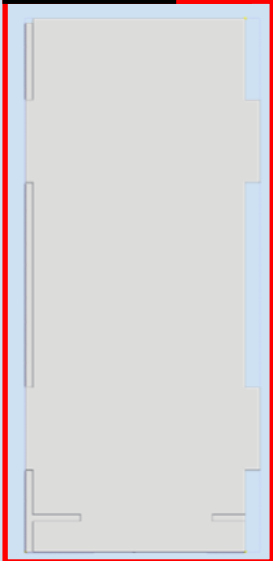

E1, E5a & E6a

