

**7B-002-004 Instructions**  
**Part 2**

**50**

**G6(x3)**



**51**

**D5**

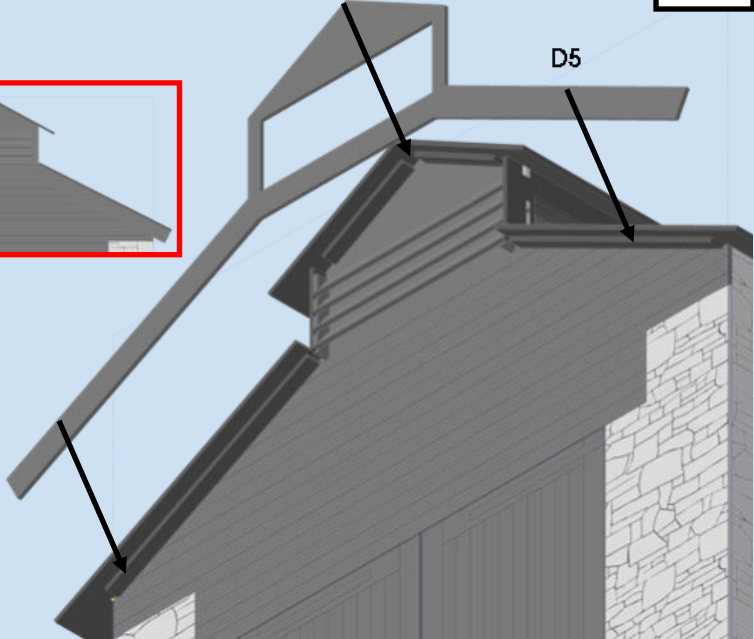

52

G5(x2)

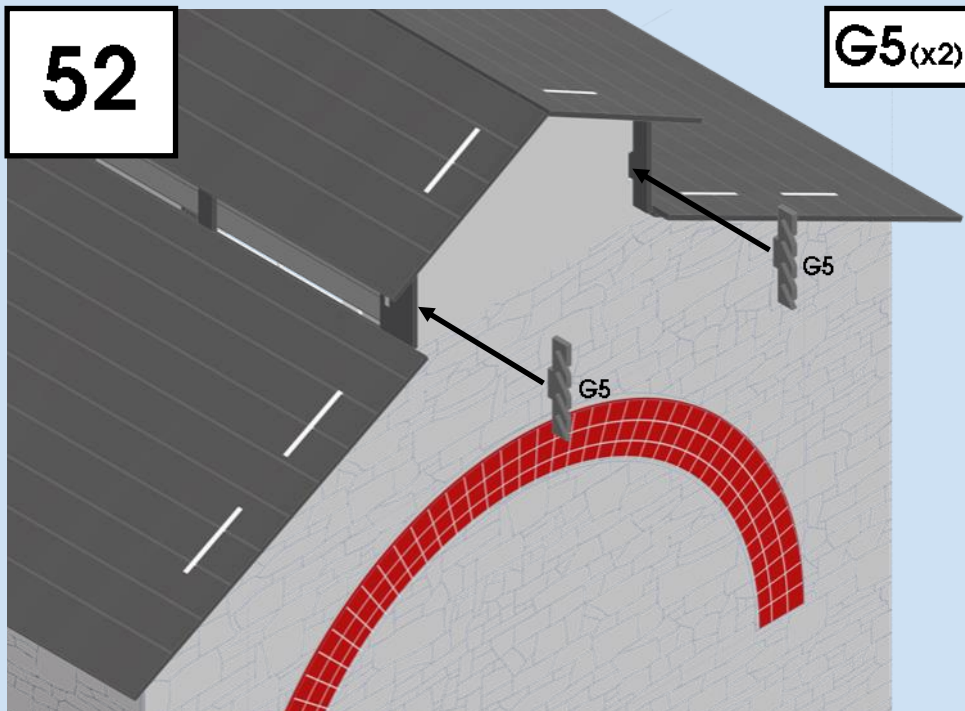

53

G6

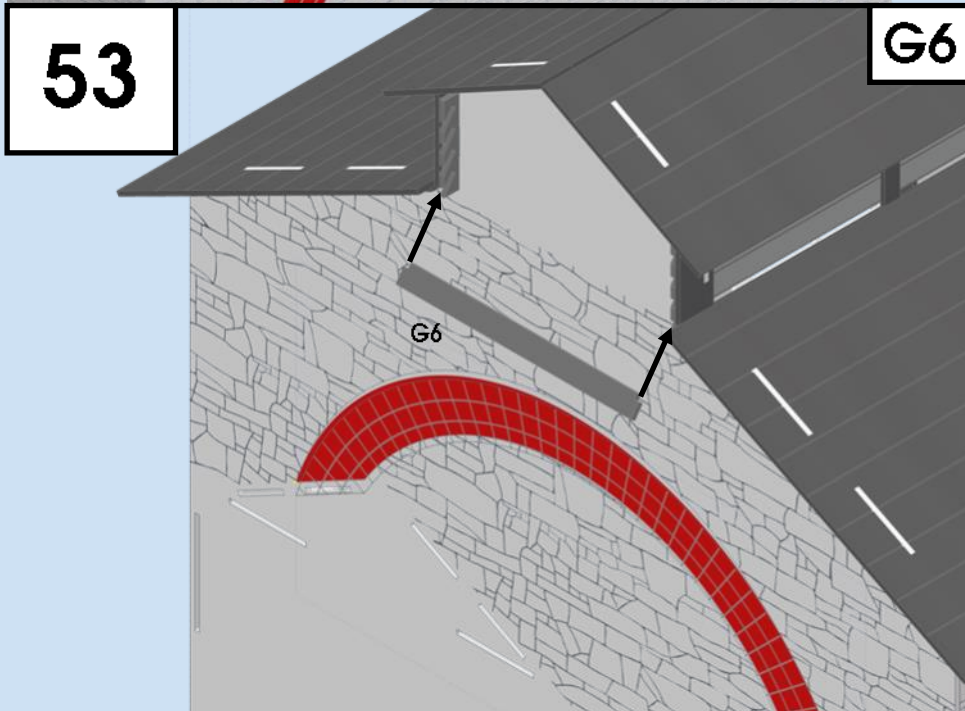

54

G6(x3)

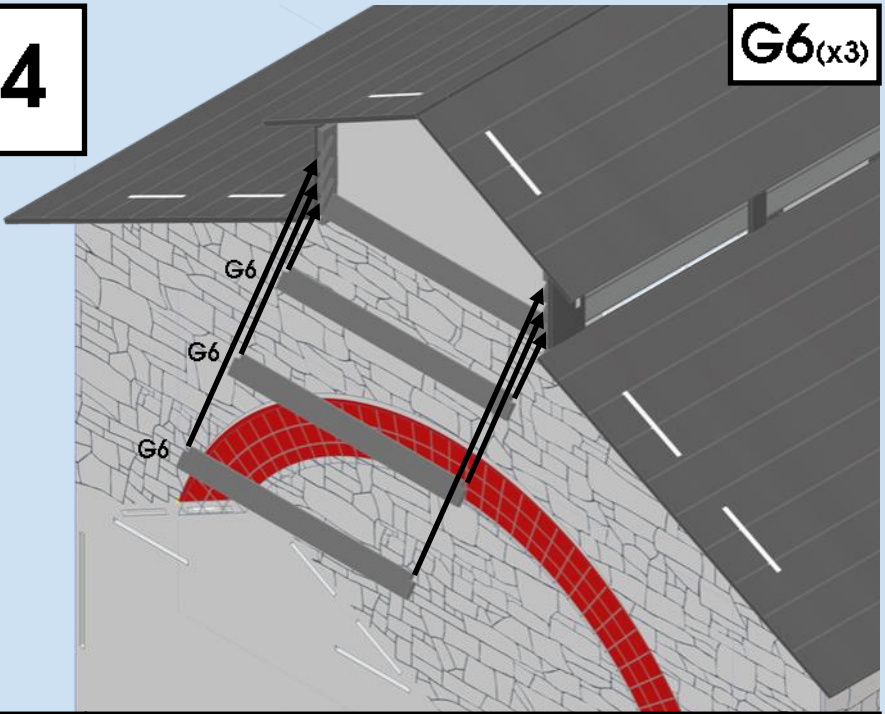

55

B4

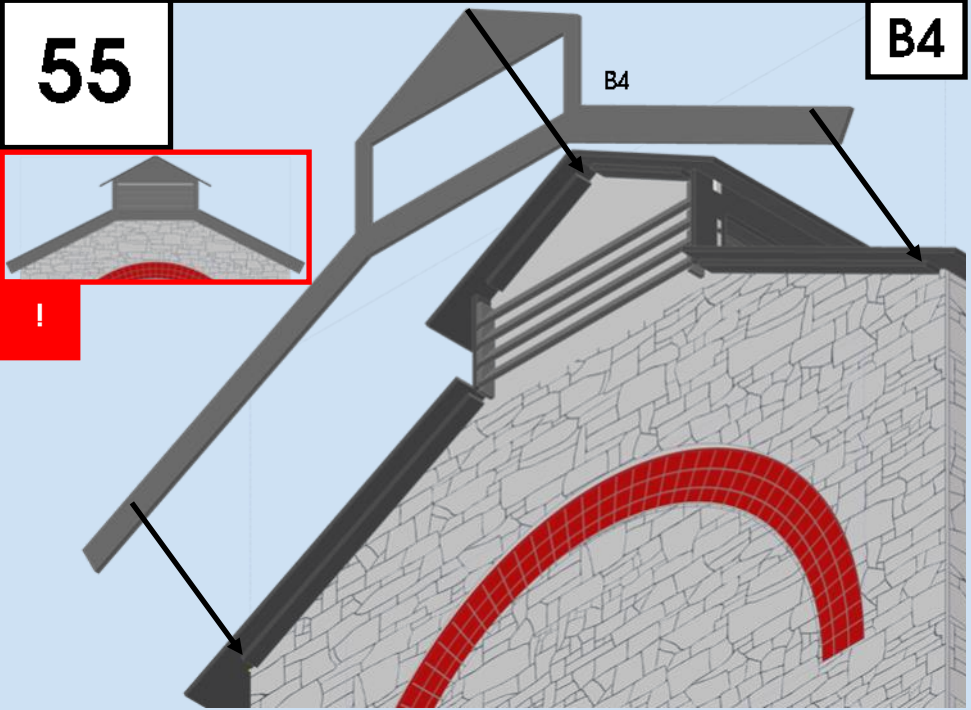



**56**

**H1 & H2**

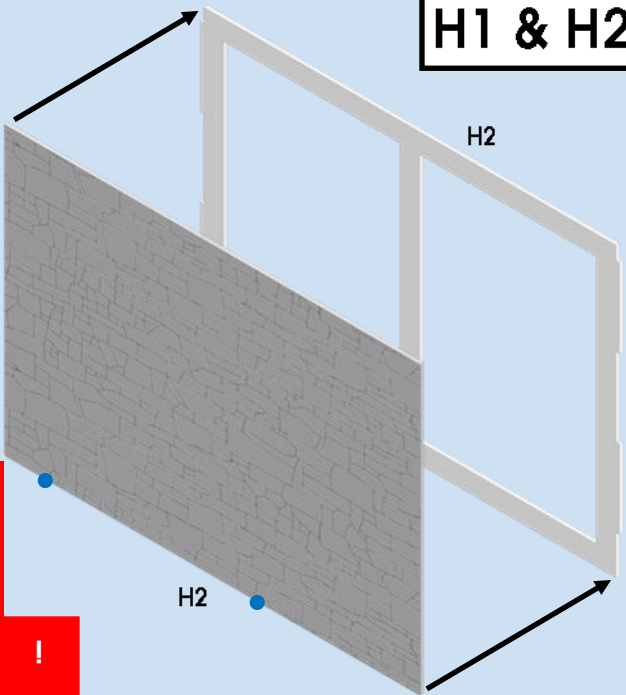
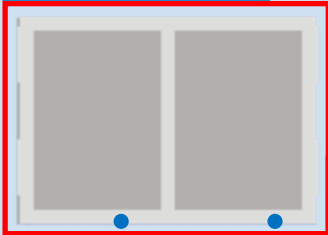
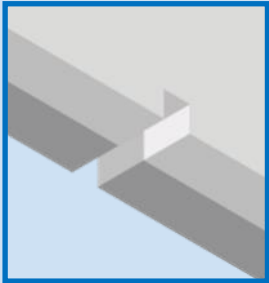

**57**

**H3**

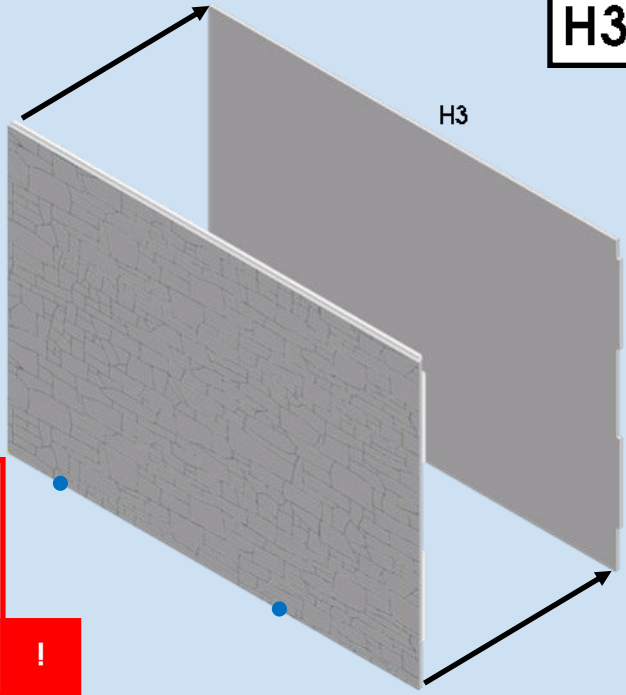
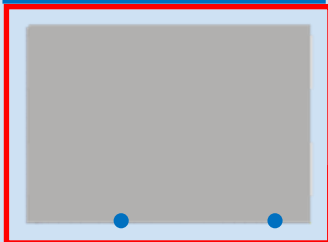
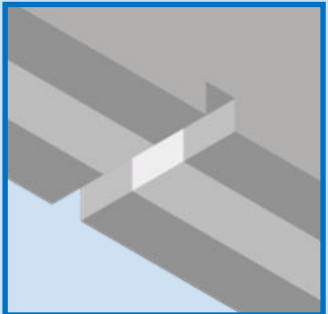

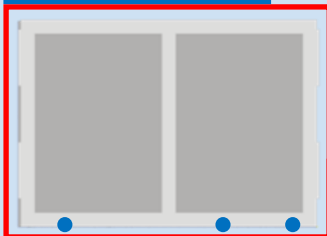
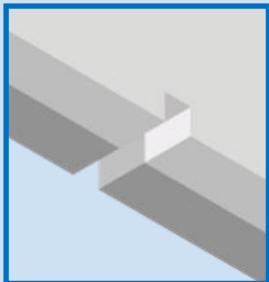
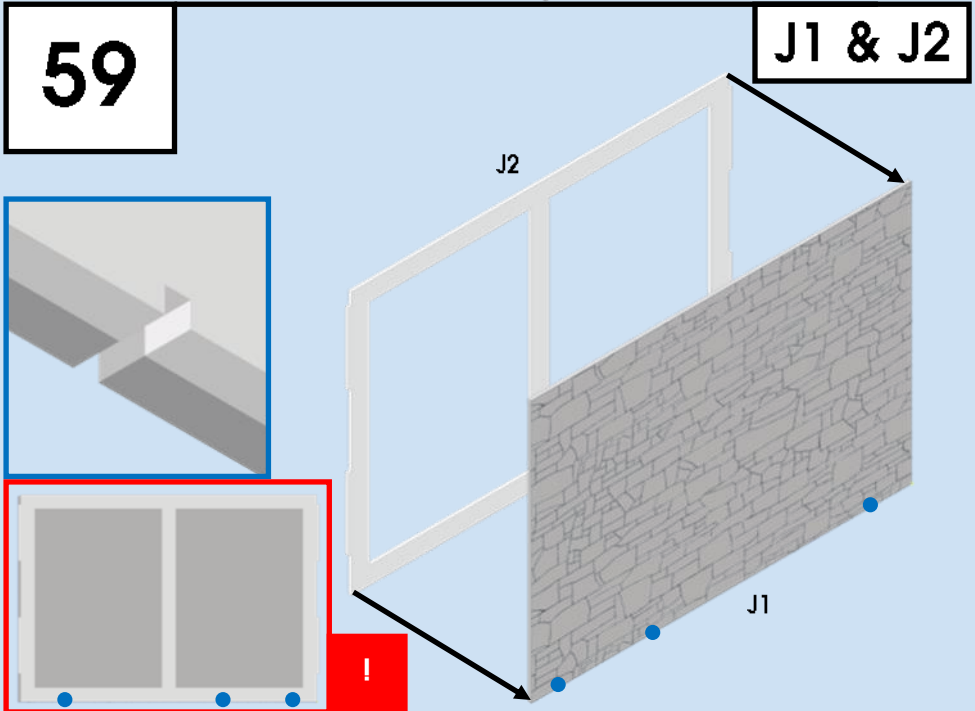
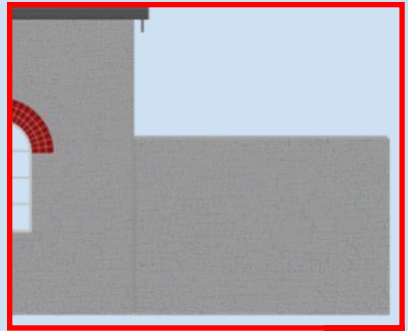
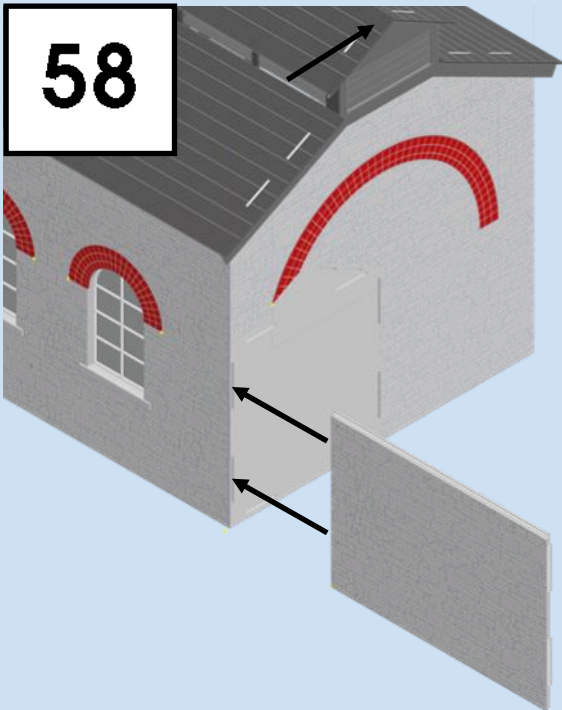

60

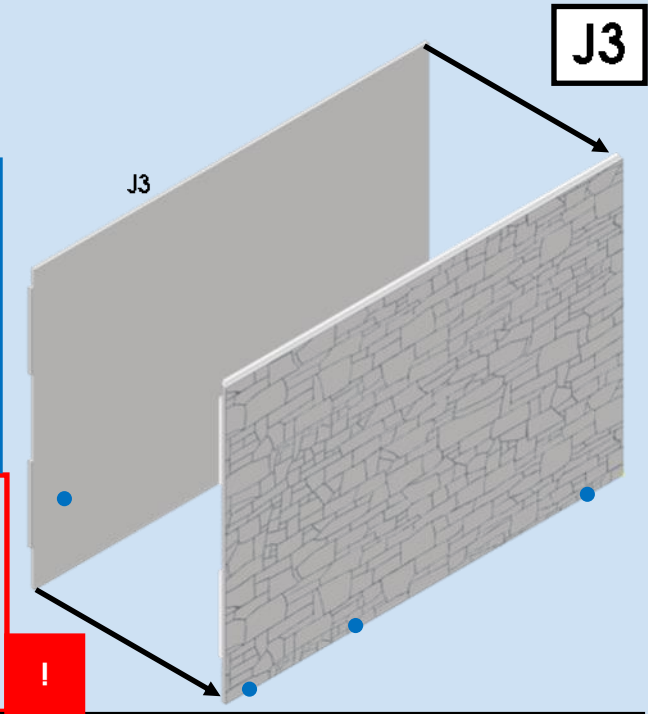
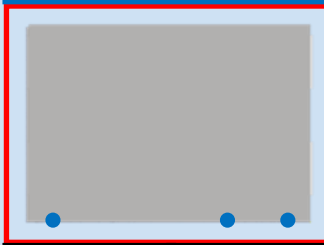
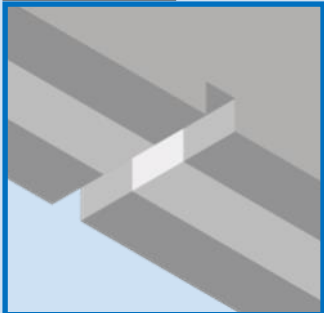

61

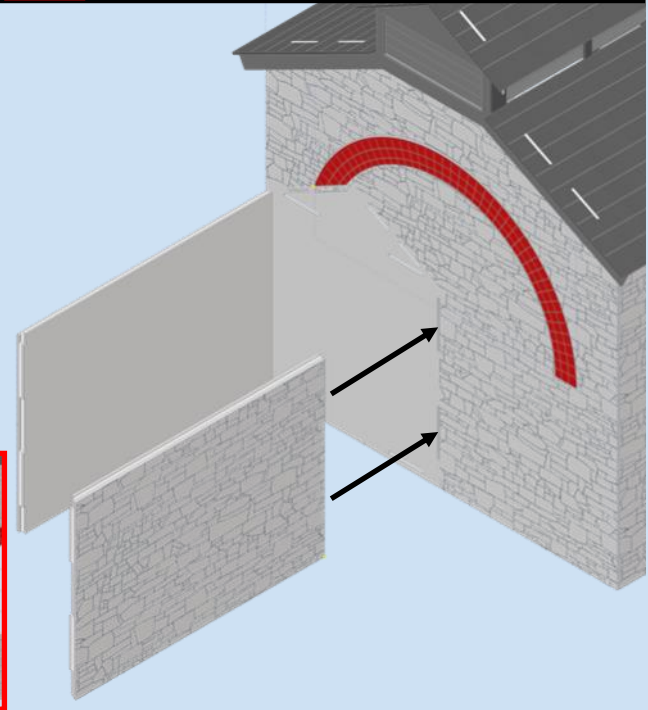
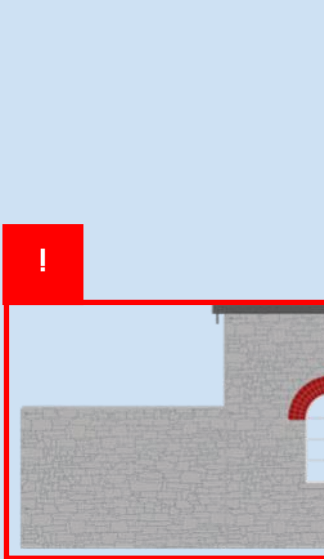

62

K1 & K2

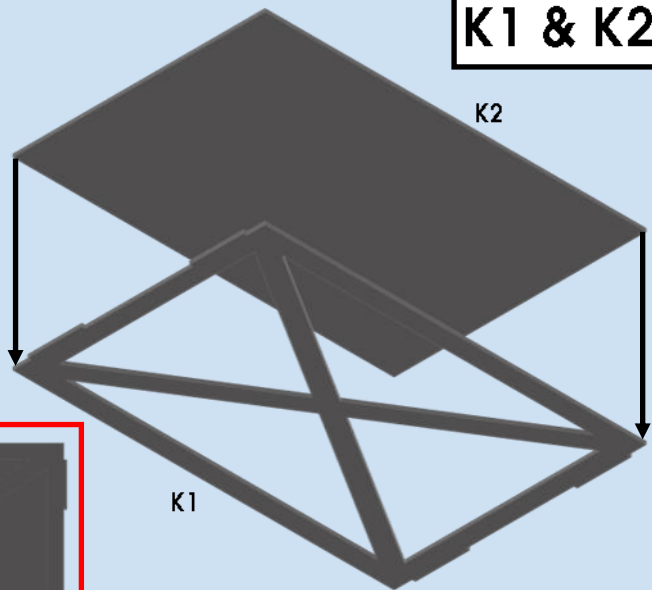

!

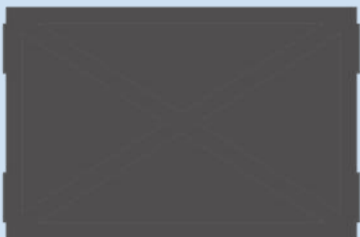

63

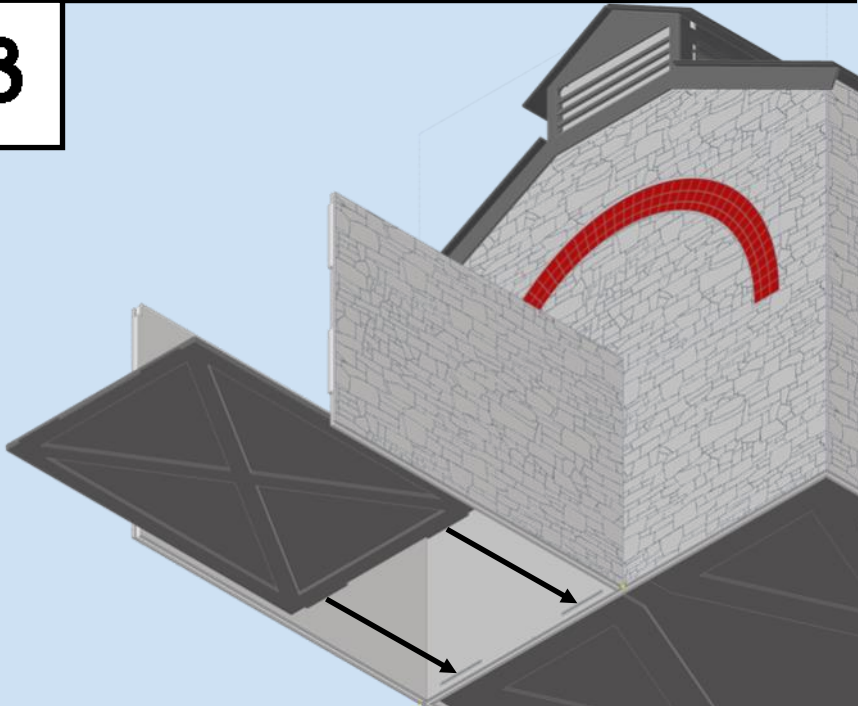

64

K3

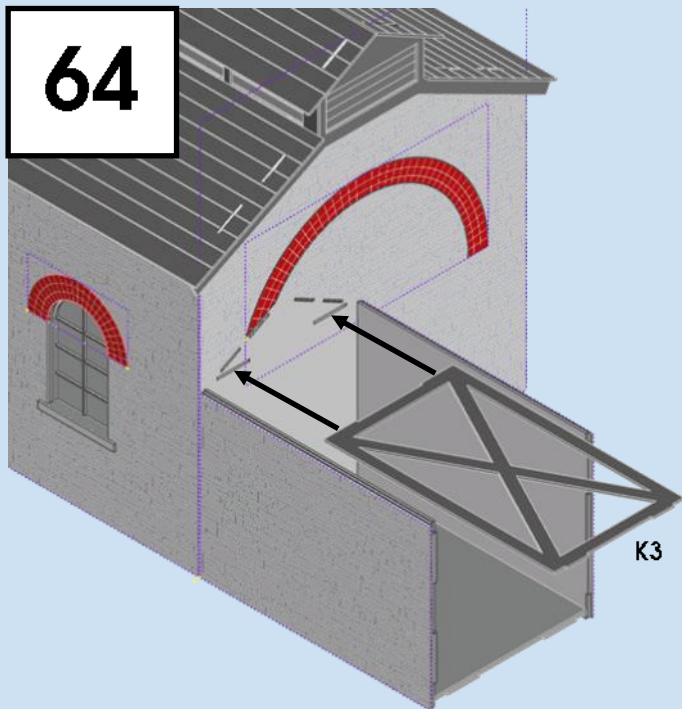

65

11 & 12

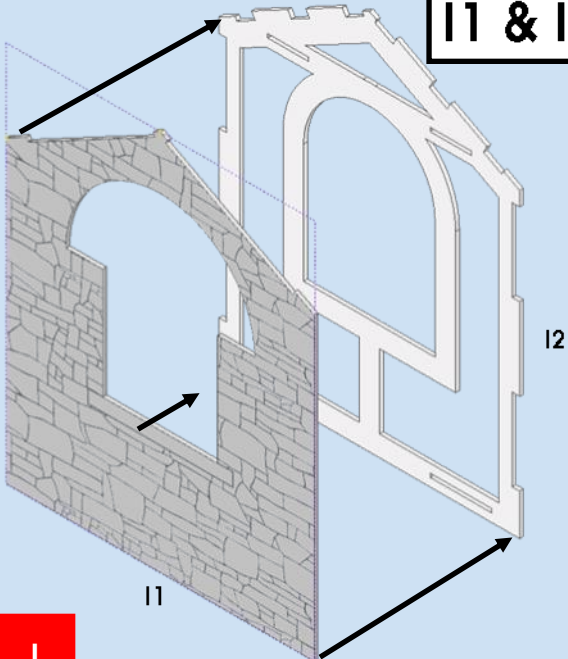
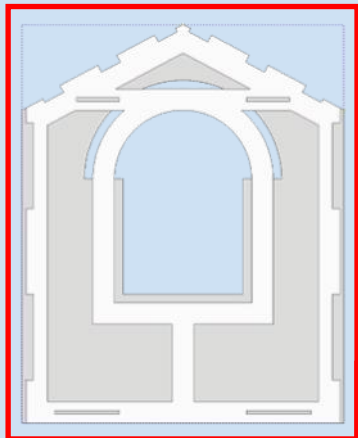



**66**

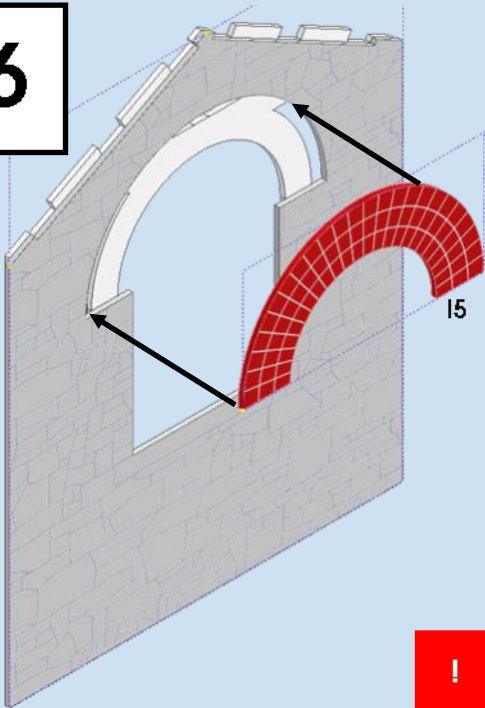

**15**

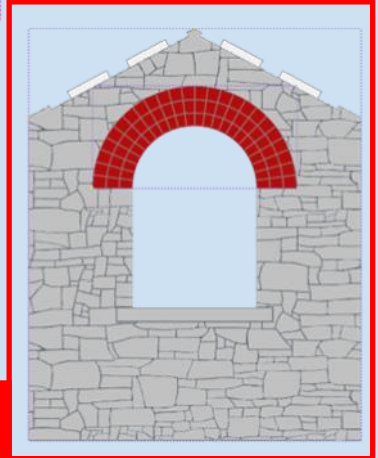

**67**

**13(x2) & 14(inc. Glazing)**

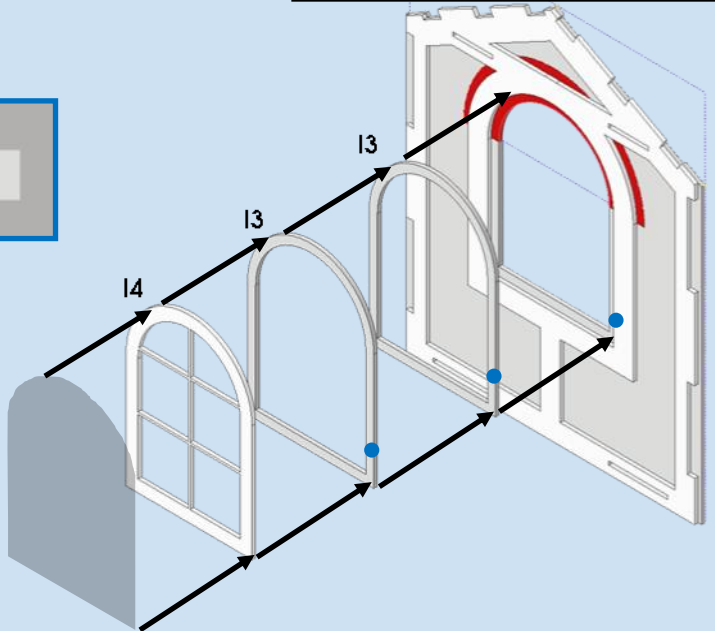
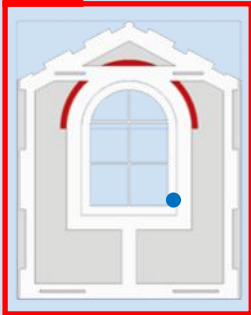

68



16

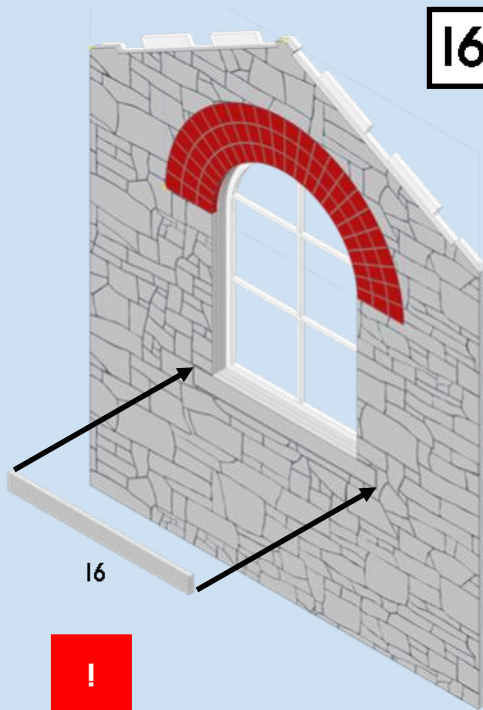

69

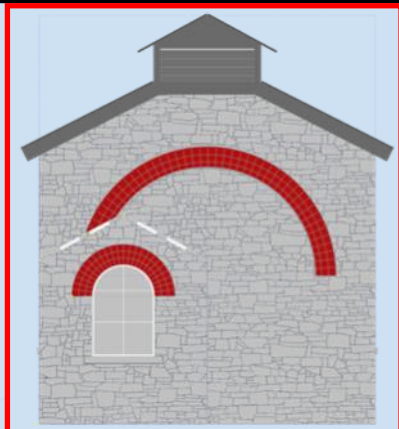
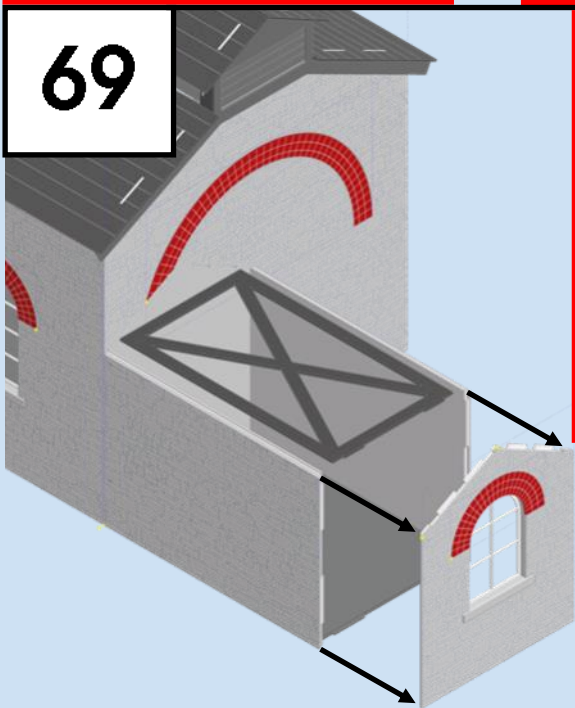

**70**

**L1 (x2)**

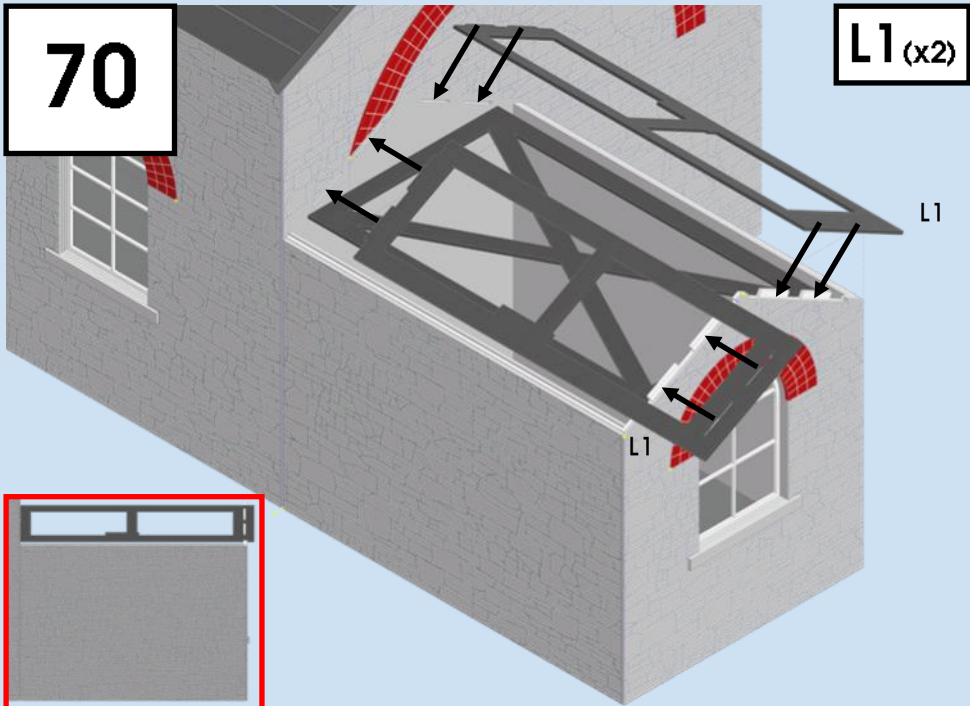

**71**

**L2**

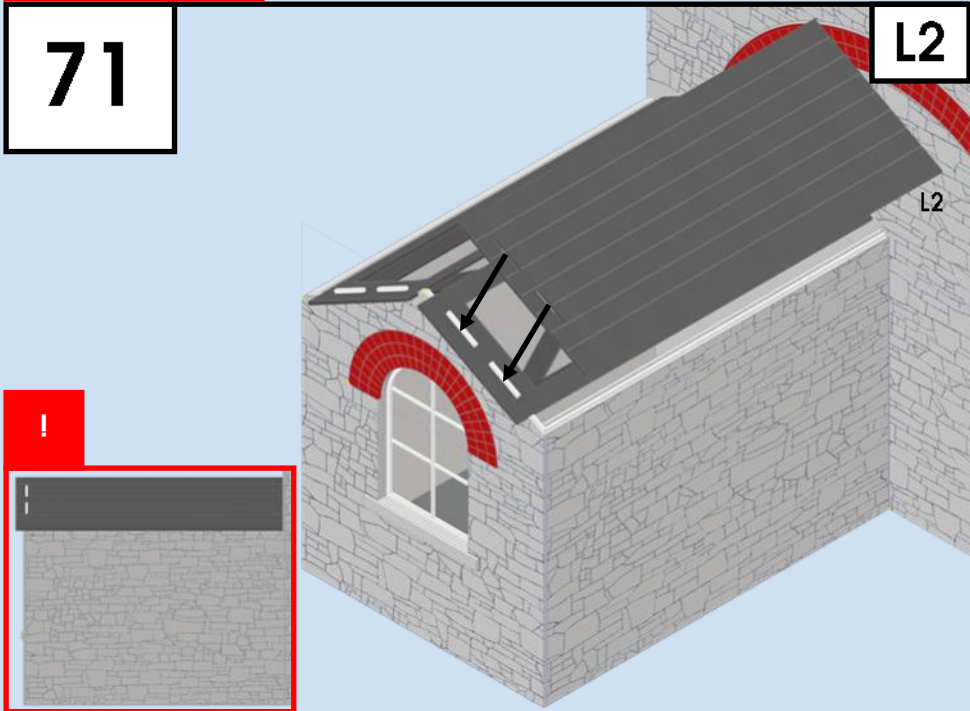

72

L3

L3

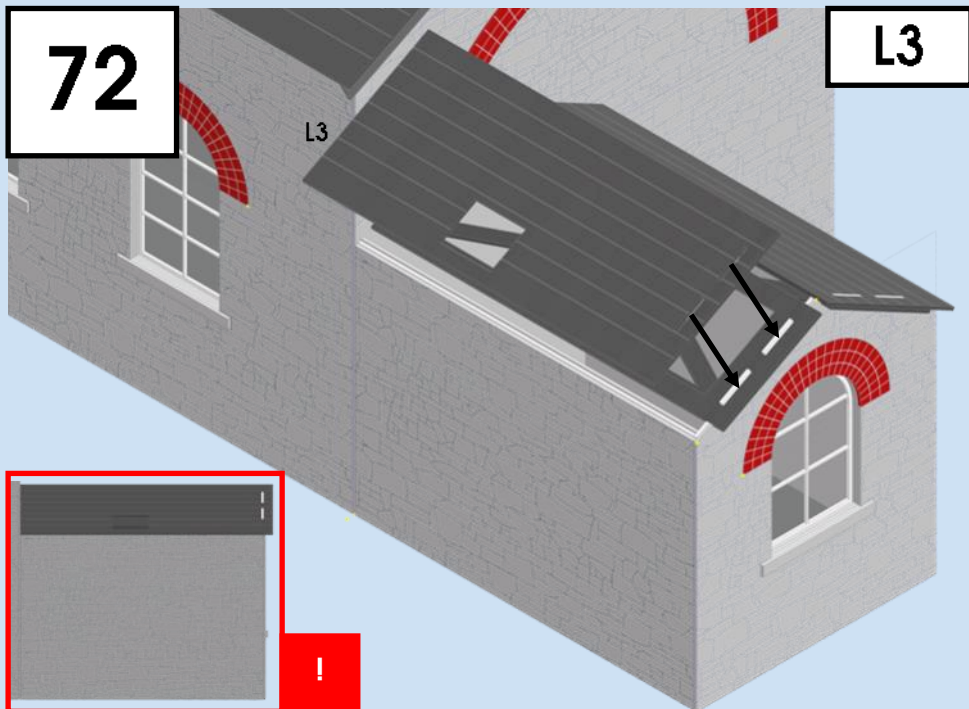

73

M1 & M5

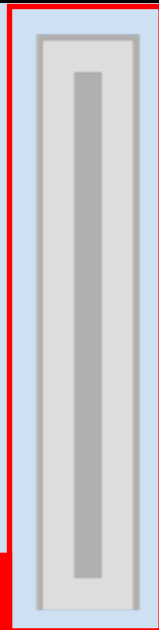
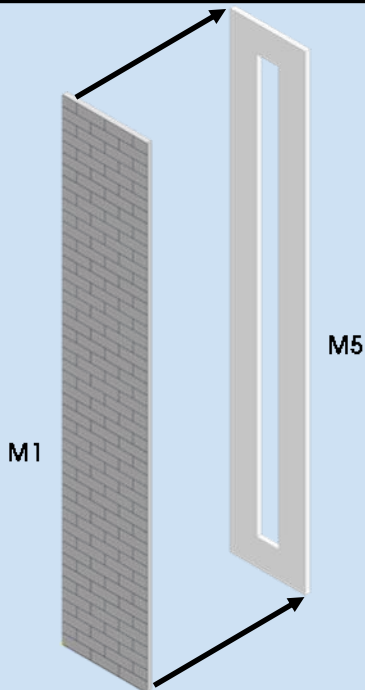

**74**

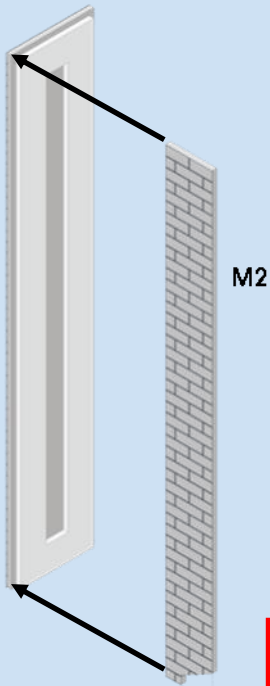

**M2**

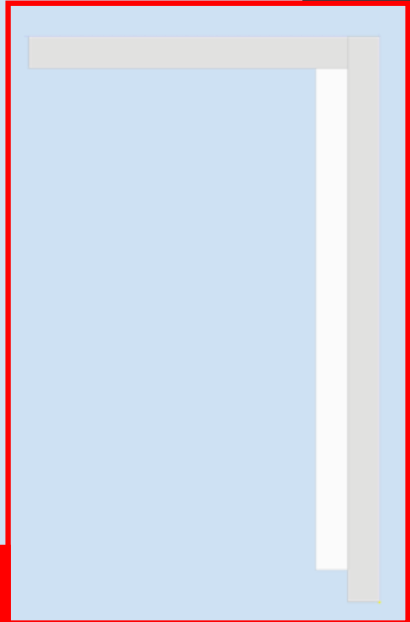

**75**

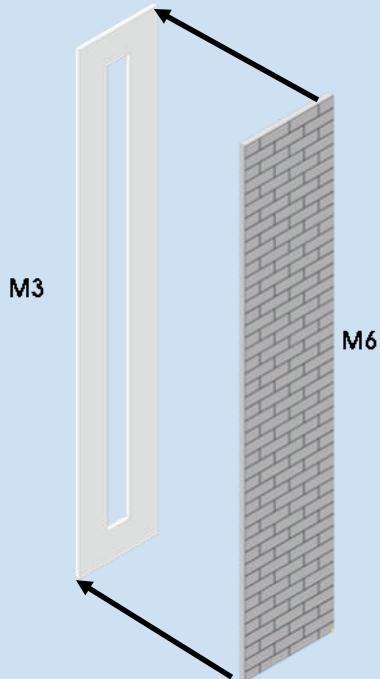

**M3 & M6**

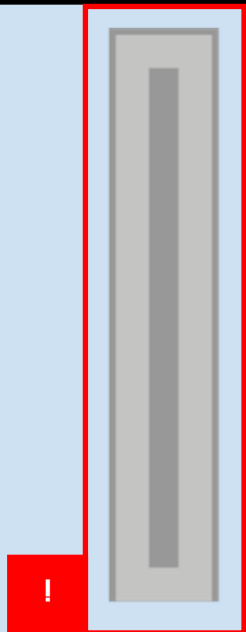



**76**

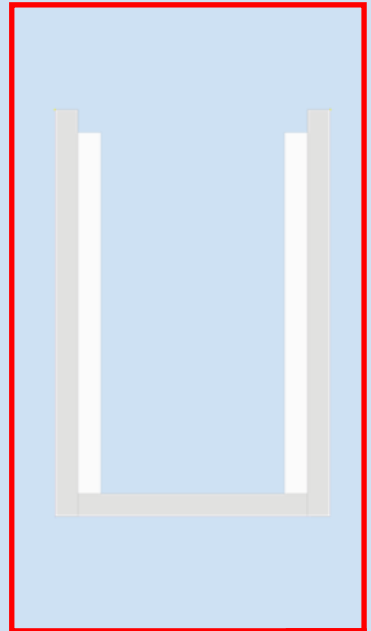

**77**

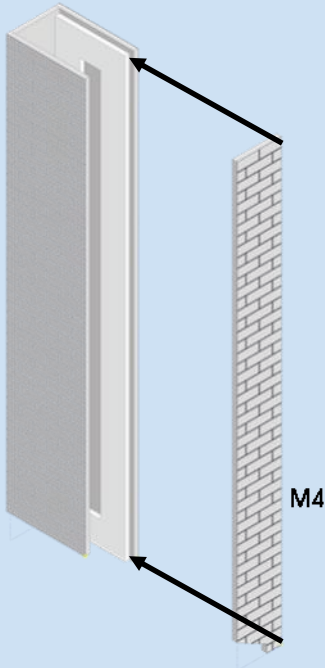

**M4**

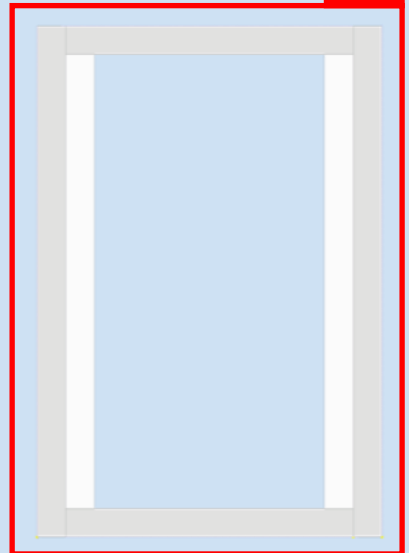

78

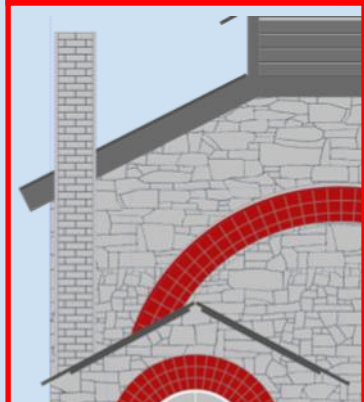
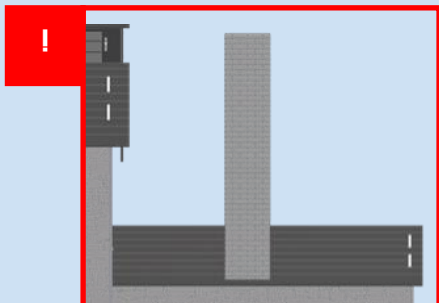
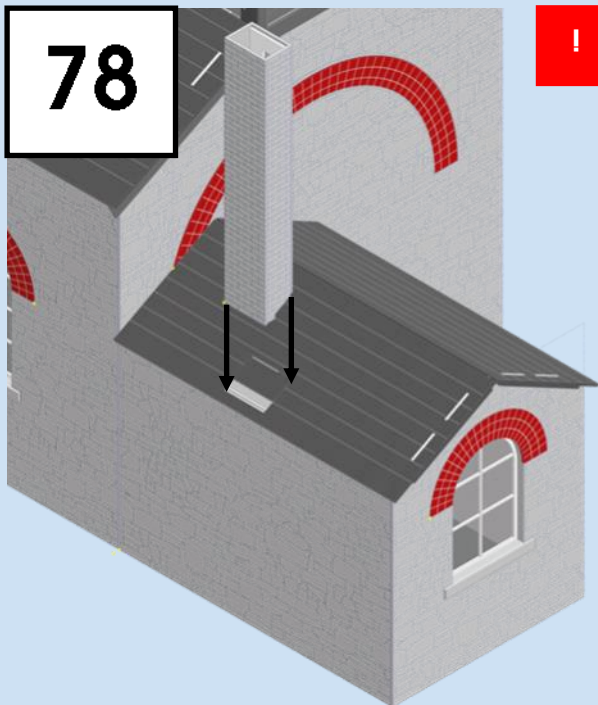

79

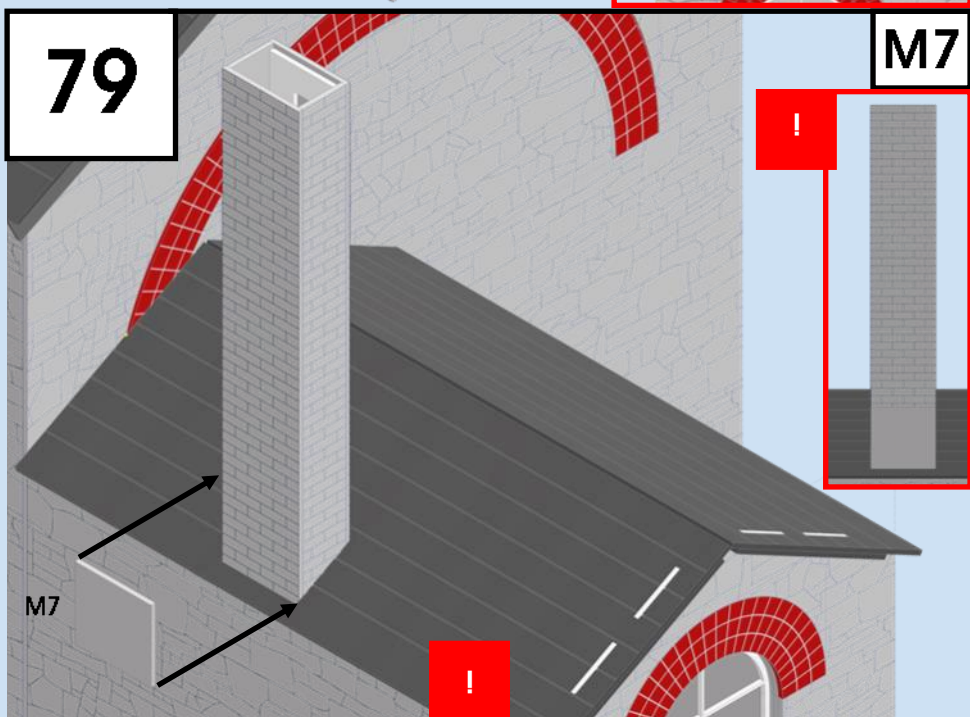

M7

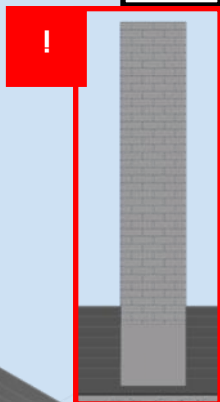

M7

80

M8

!

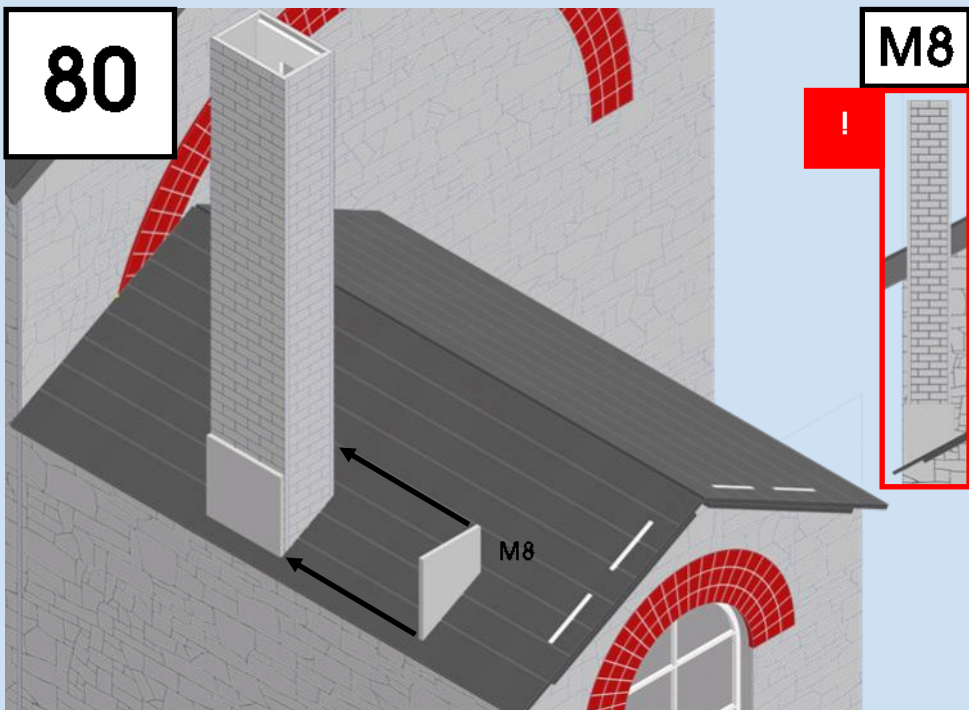

81

M10

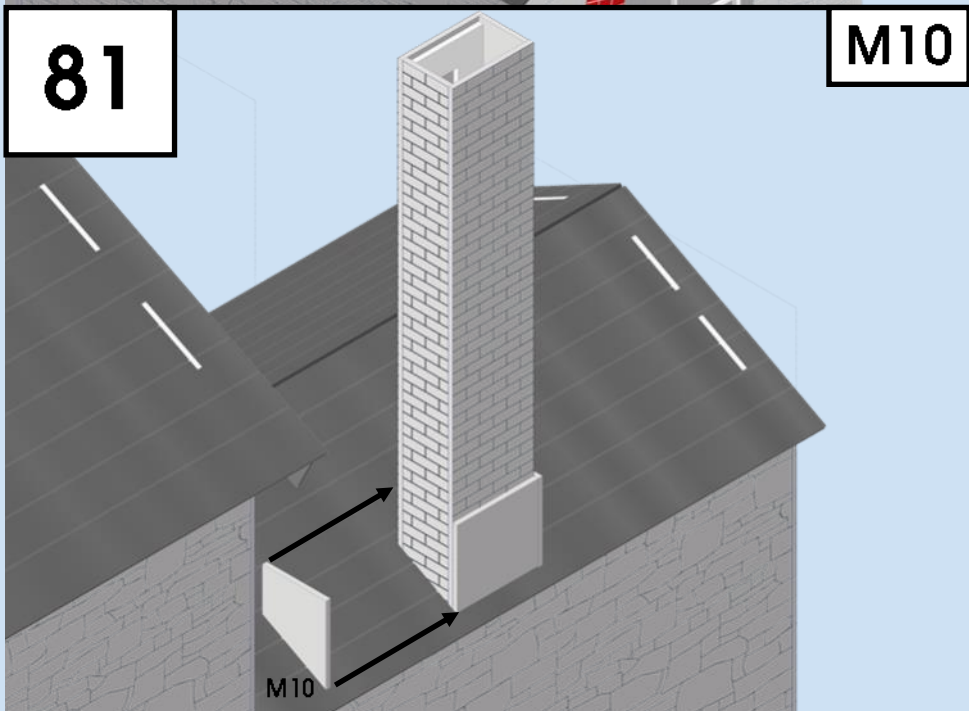

82

M9

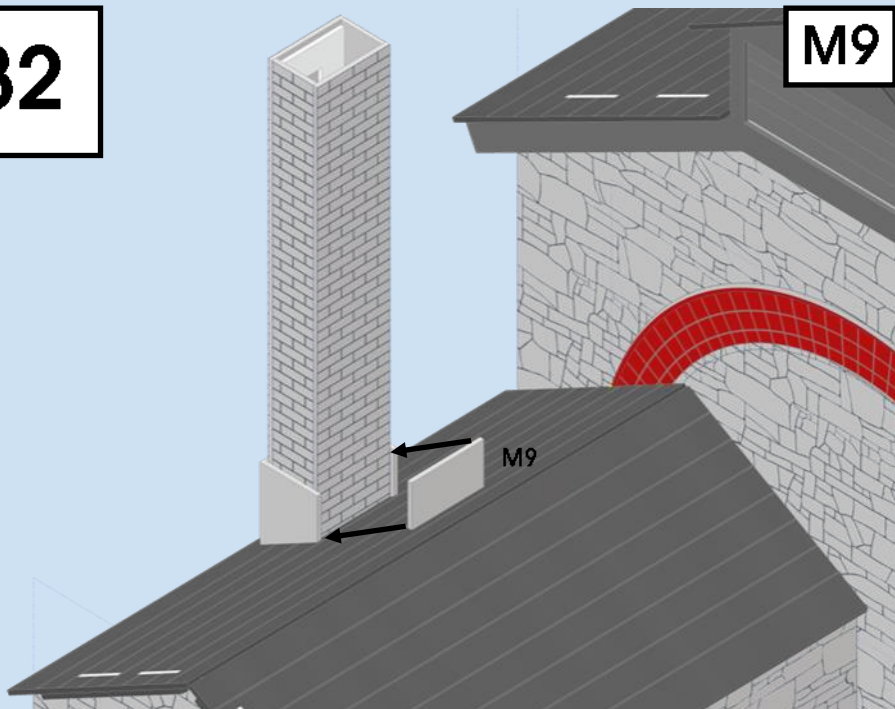

83

M11

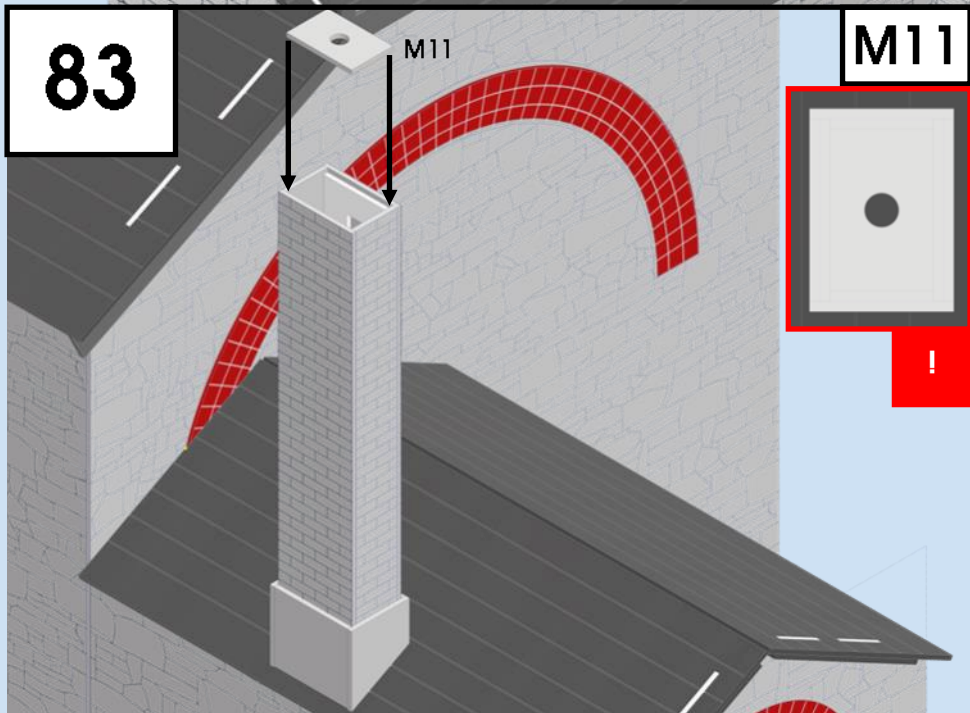



**84**

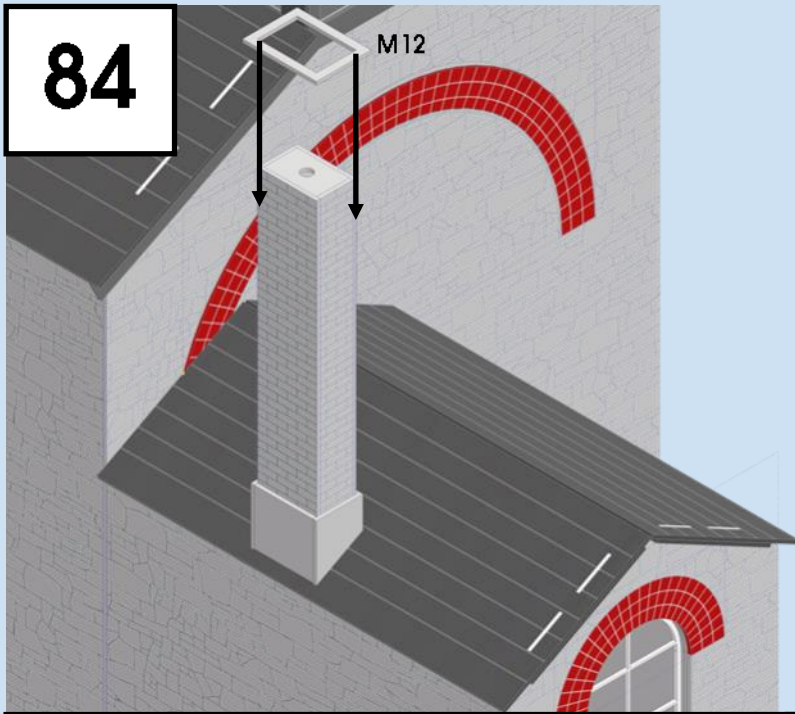

**M12**

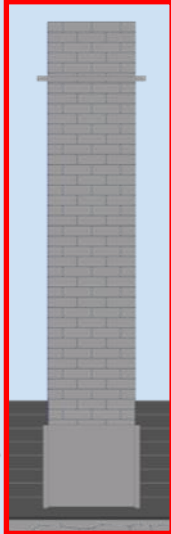

**85**

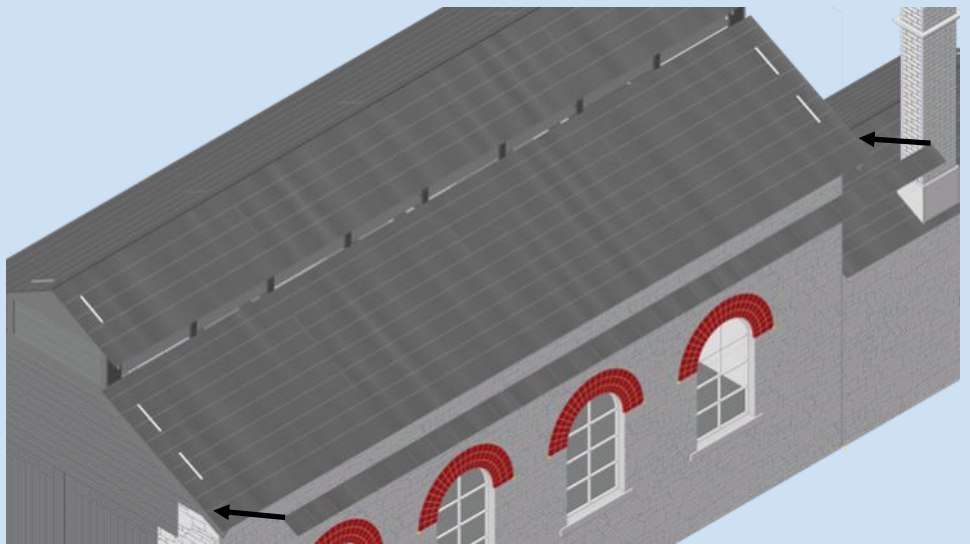

**Tiles A**



86

Tiles B

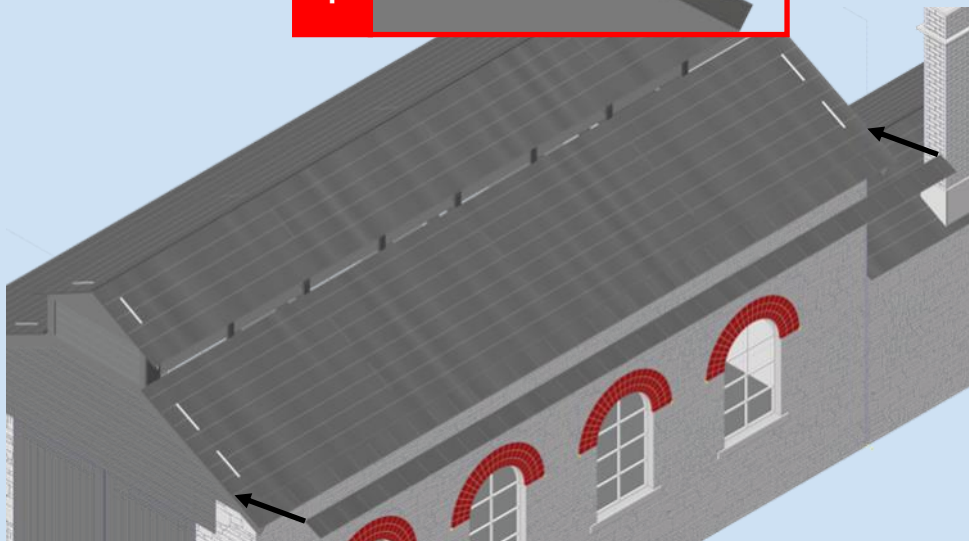

87

Repeat with Tiles  
A - B - A - B - A - B - A - C

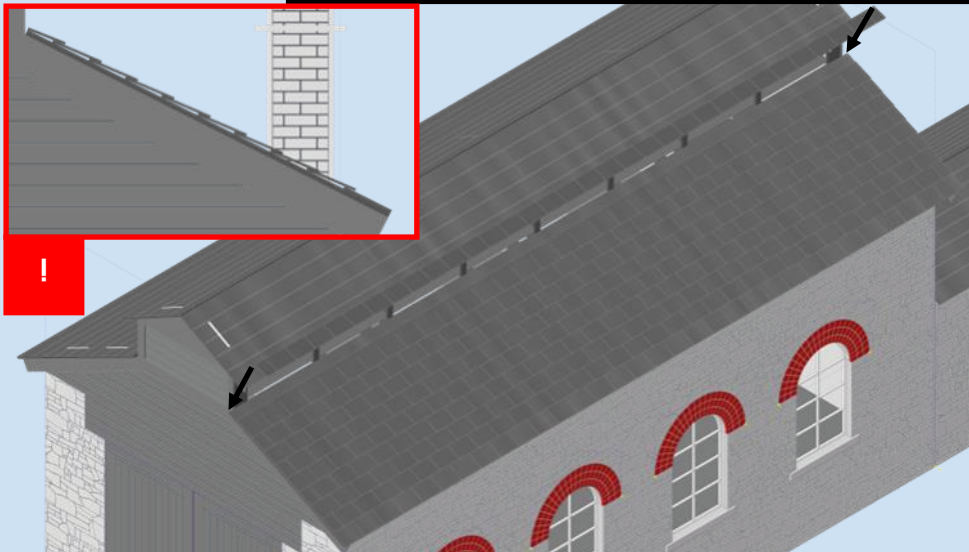

88



Tiles A

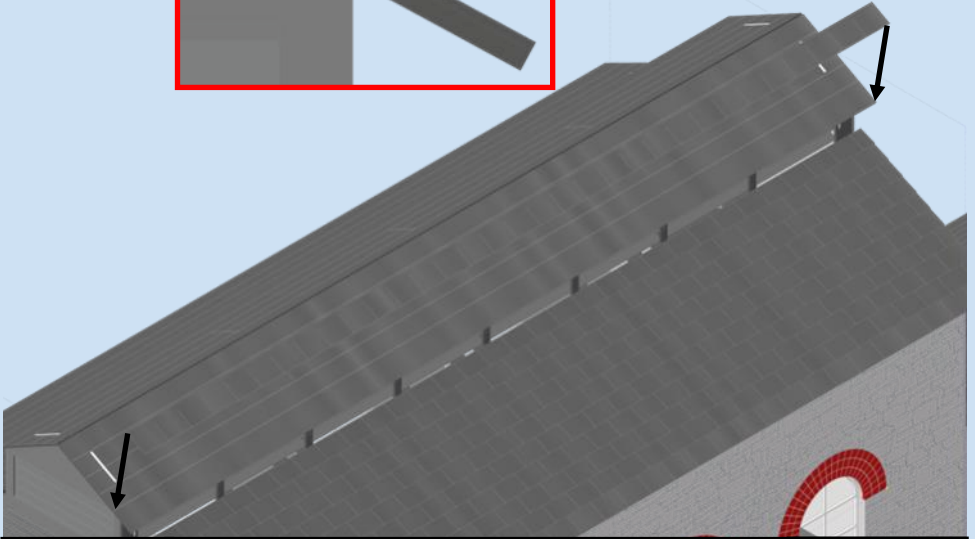

89

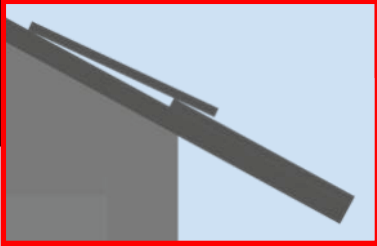

Tiles B

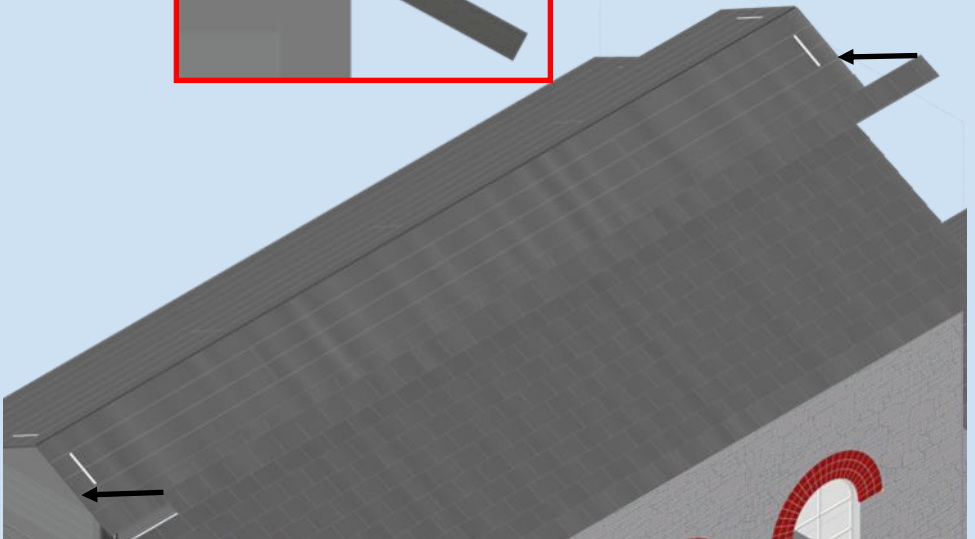

90

Repeat with Tiles A - B - A

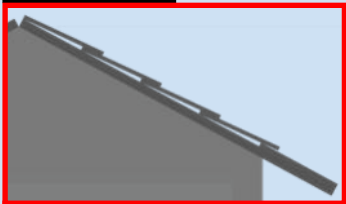

!

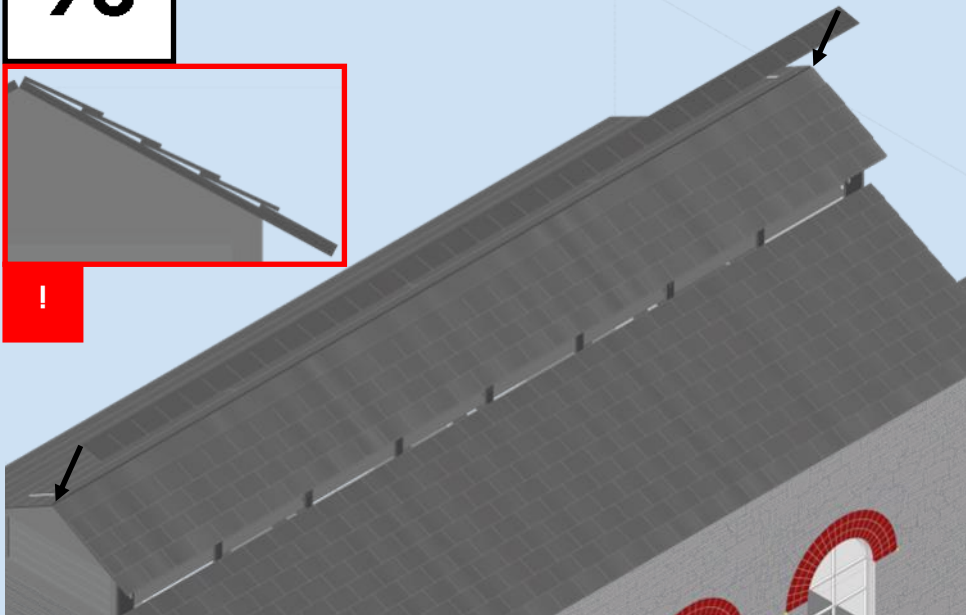

91

Repeat with Tiles on other side

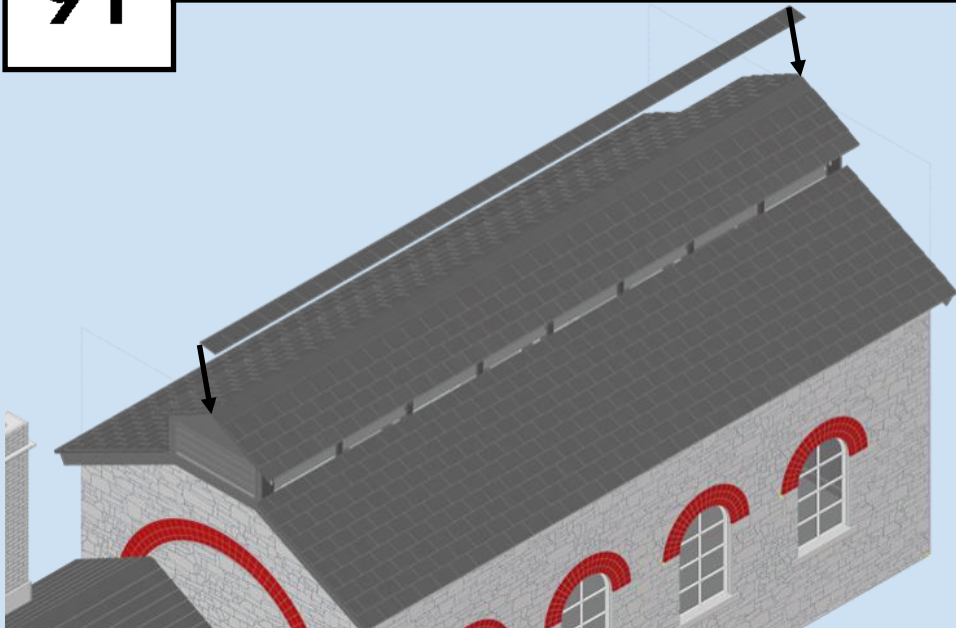

92

Tiles D

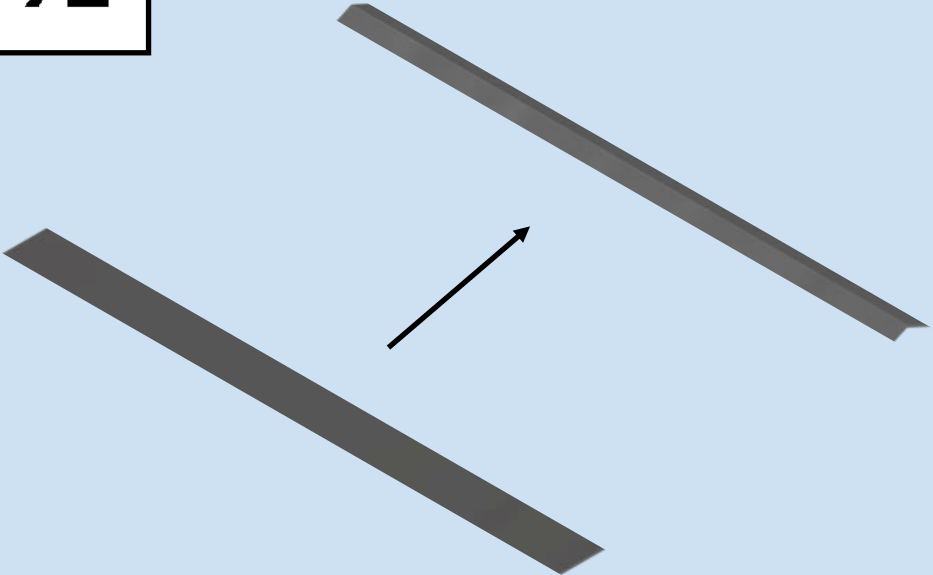

93

Tiles D

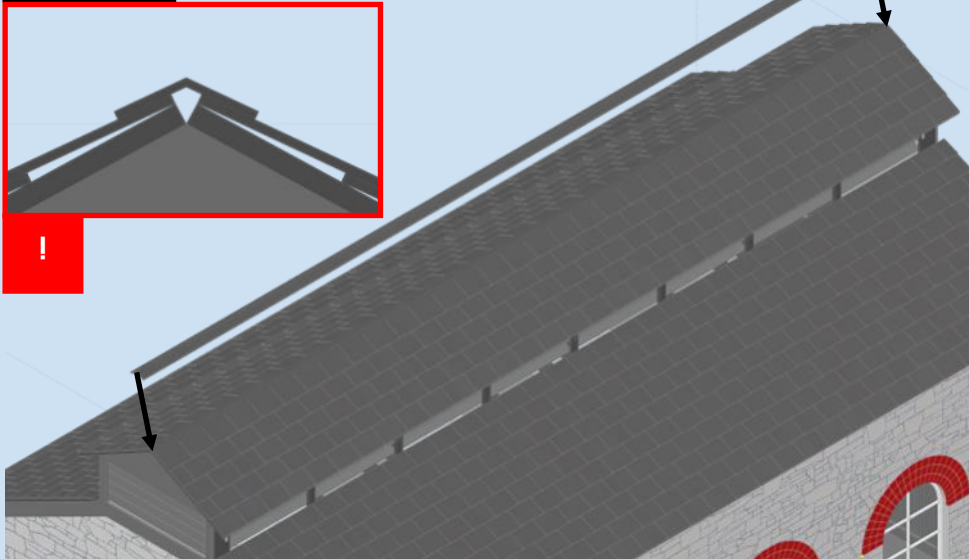

94

Tiles I

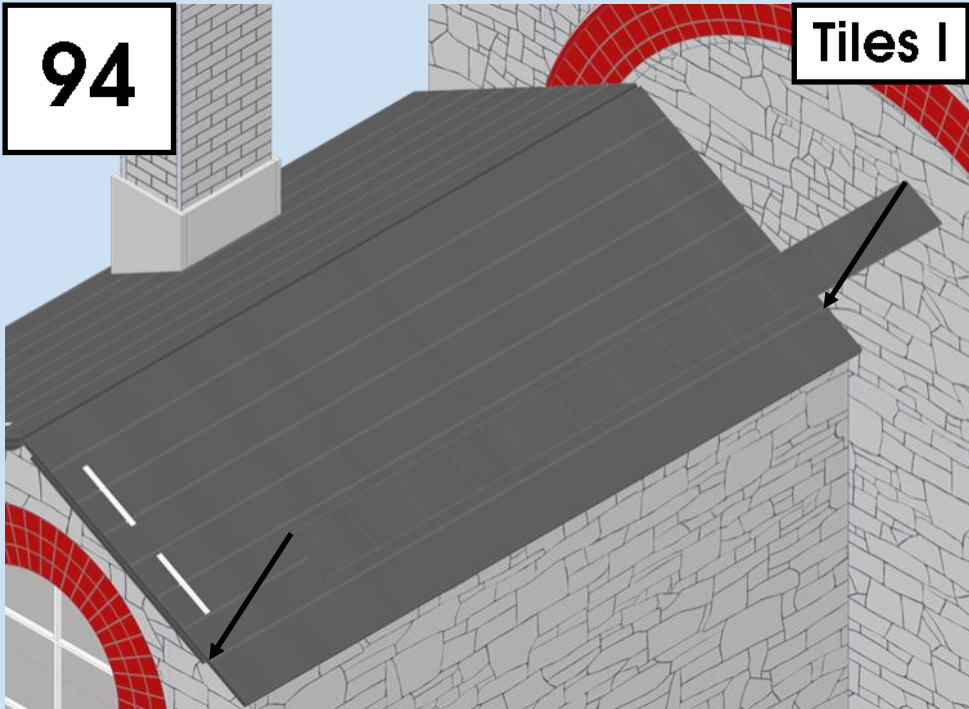

95

Tiles J

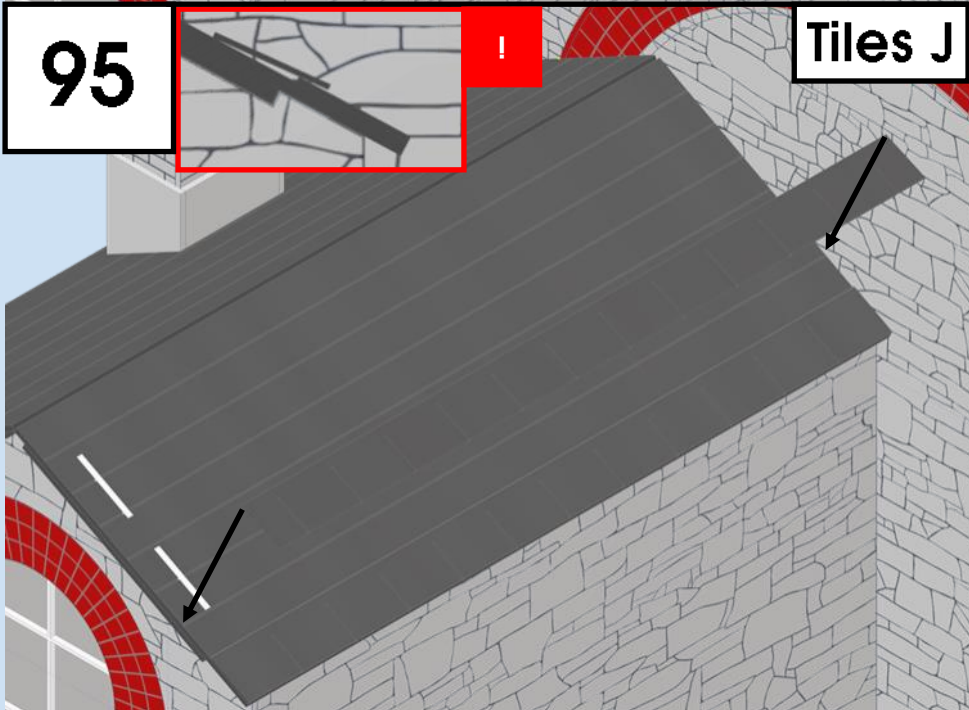



96

Repeat with Tiles

I - J - I - J - I - J

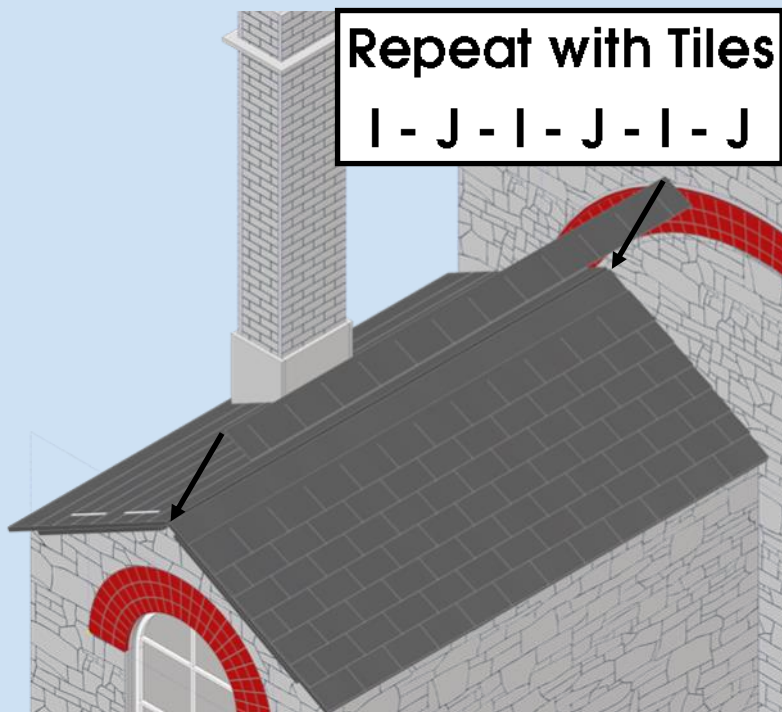

97

Tiles E

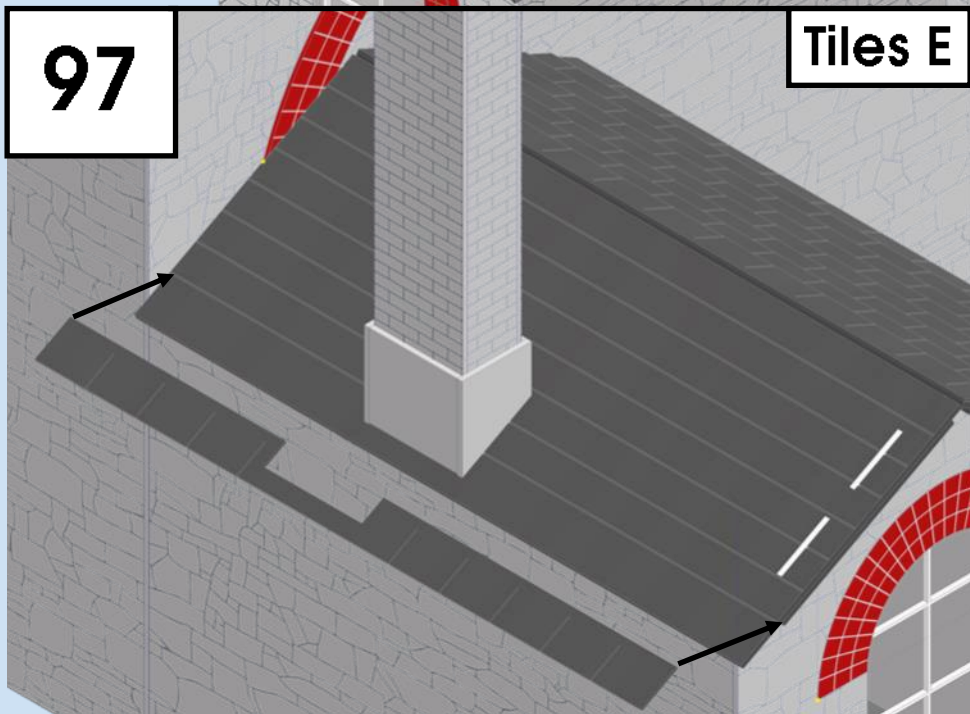

Tiles F

98

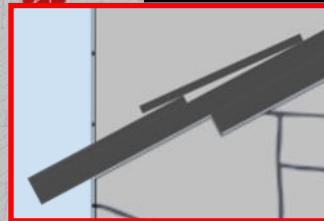

!

99

Repeat with Tiles  
G - H - I - J - I - J



!

**100**

**Tiles K**

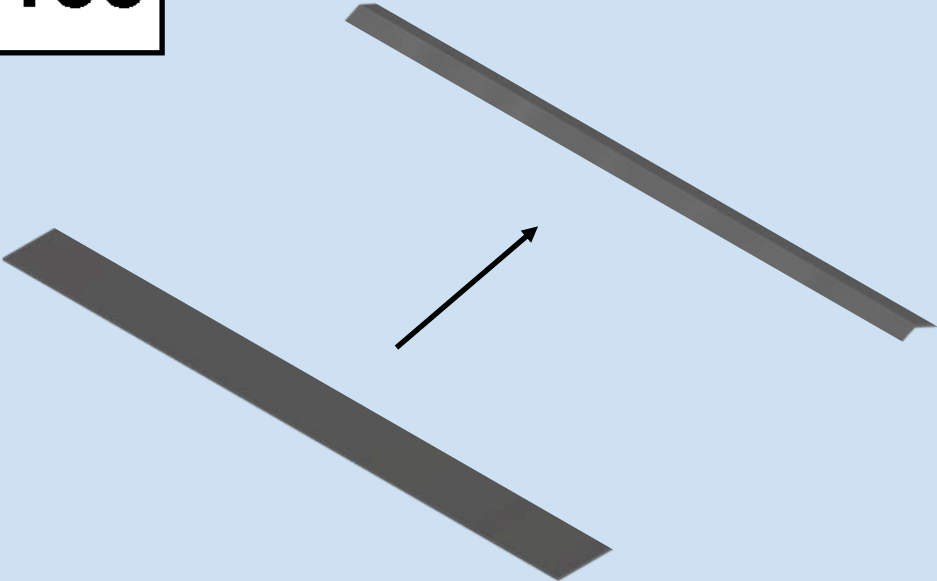

**101**

**Tiles K**

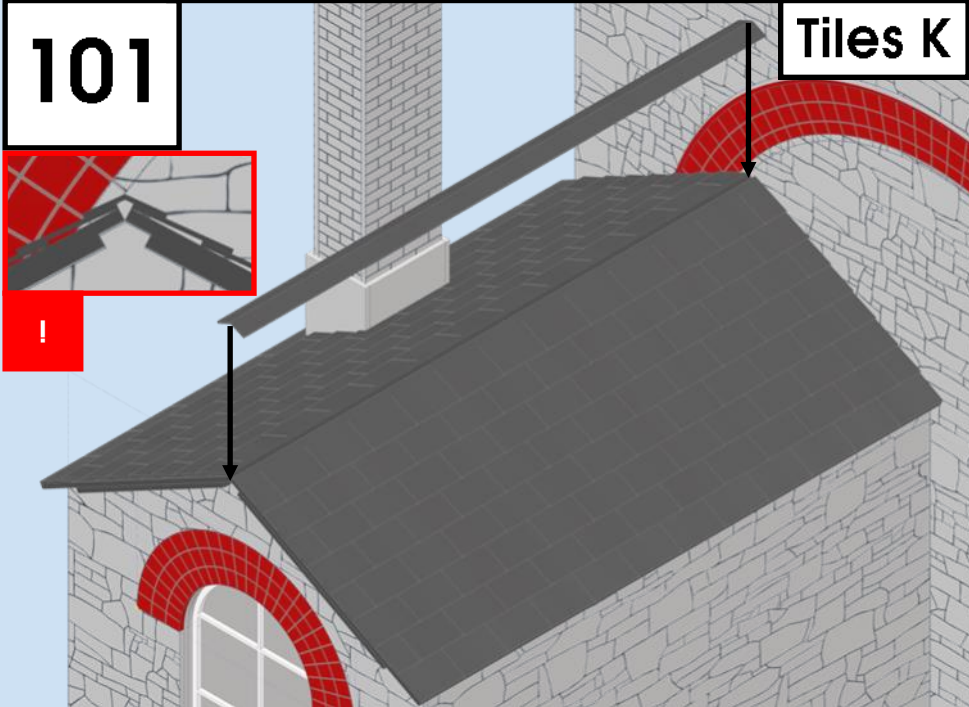

**102**

**N1 & N2**

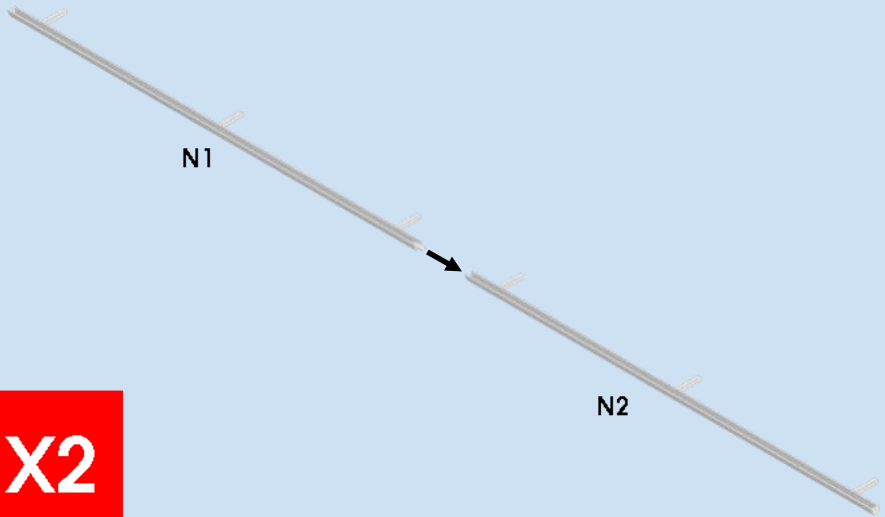

**X2**

**103**

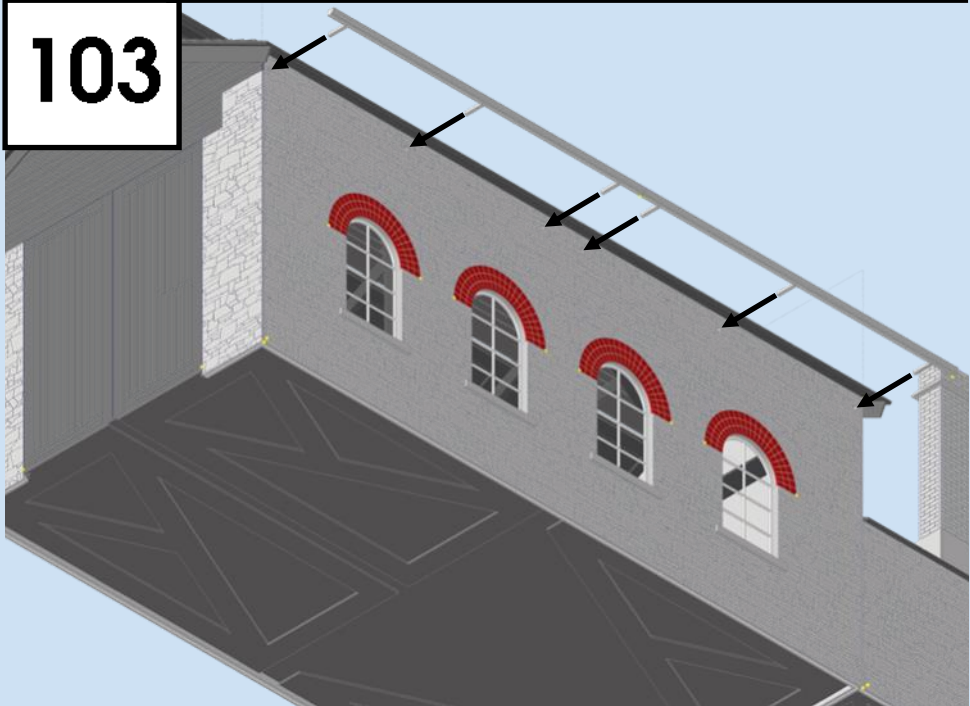



104

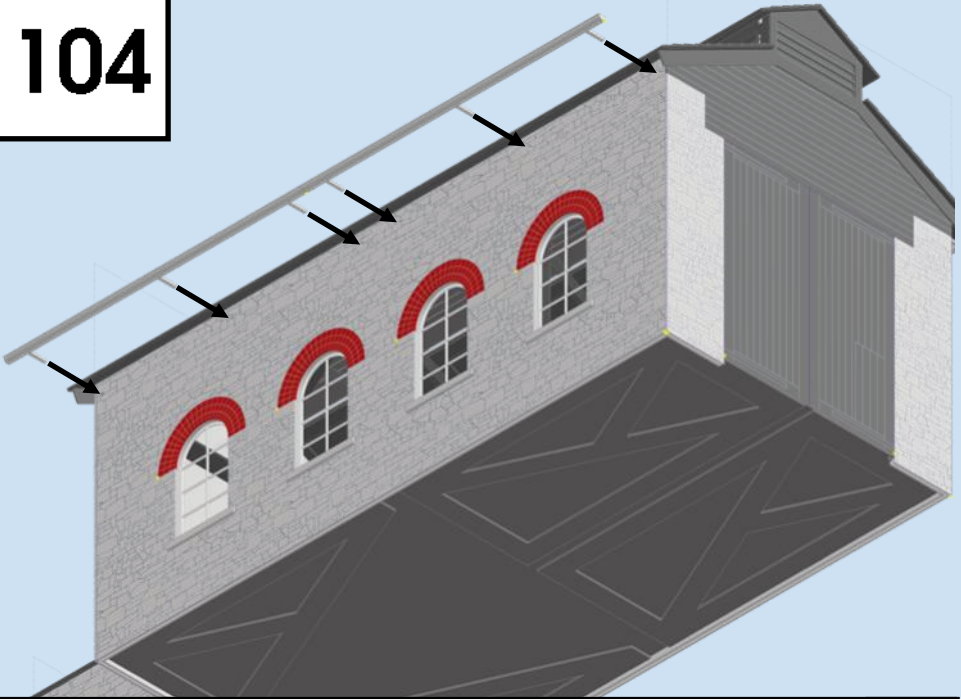

105

N3

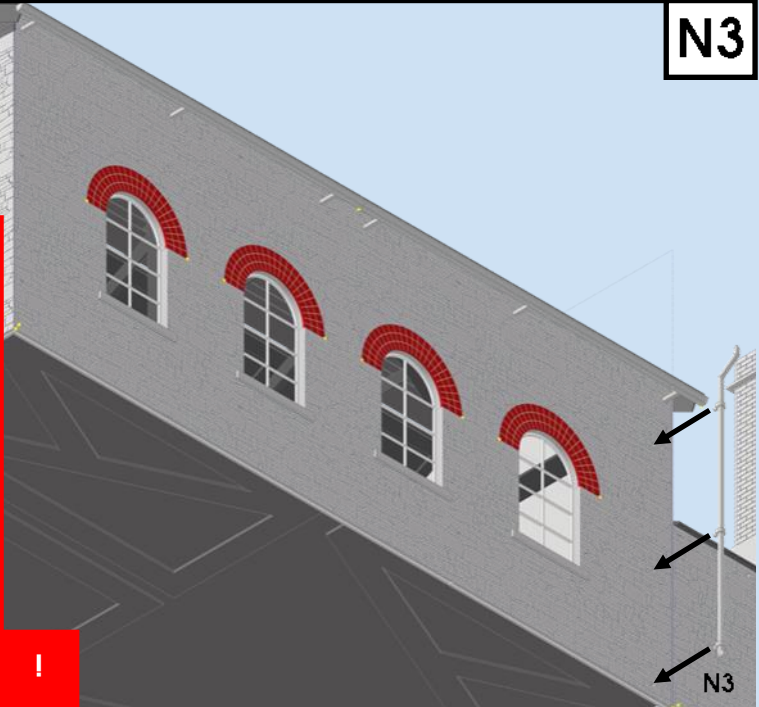
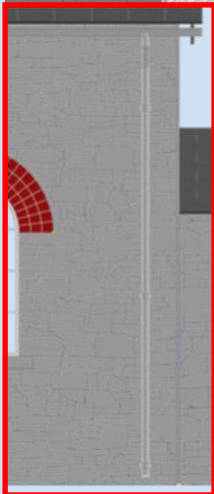

N3



**106**

**N4**

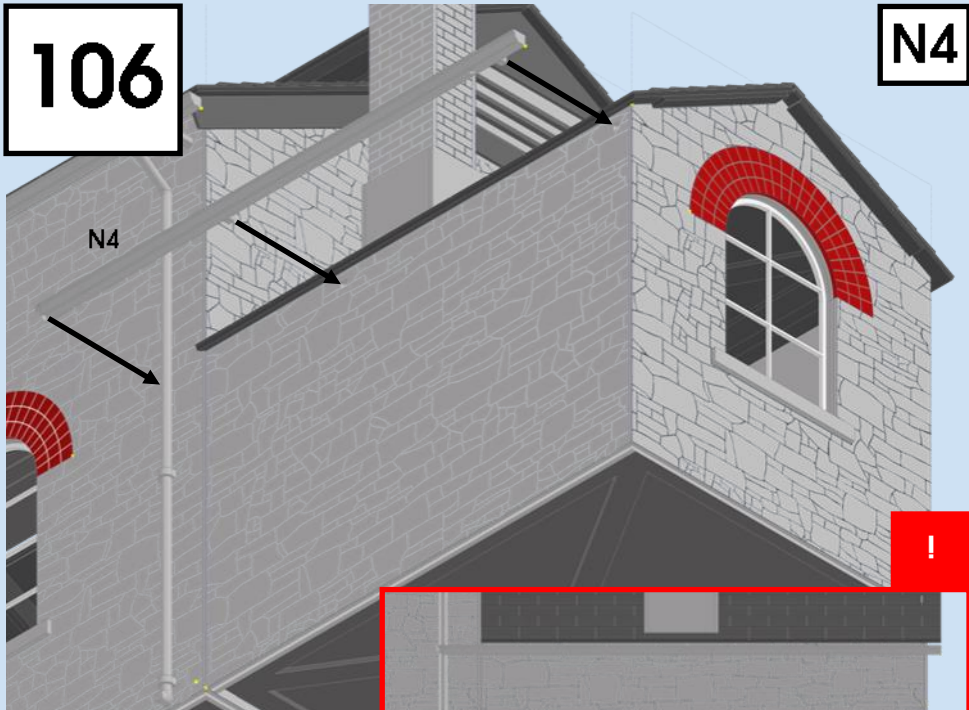

**107**

**N3**

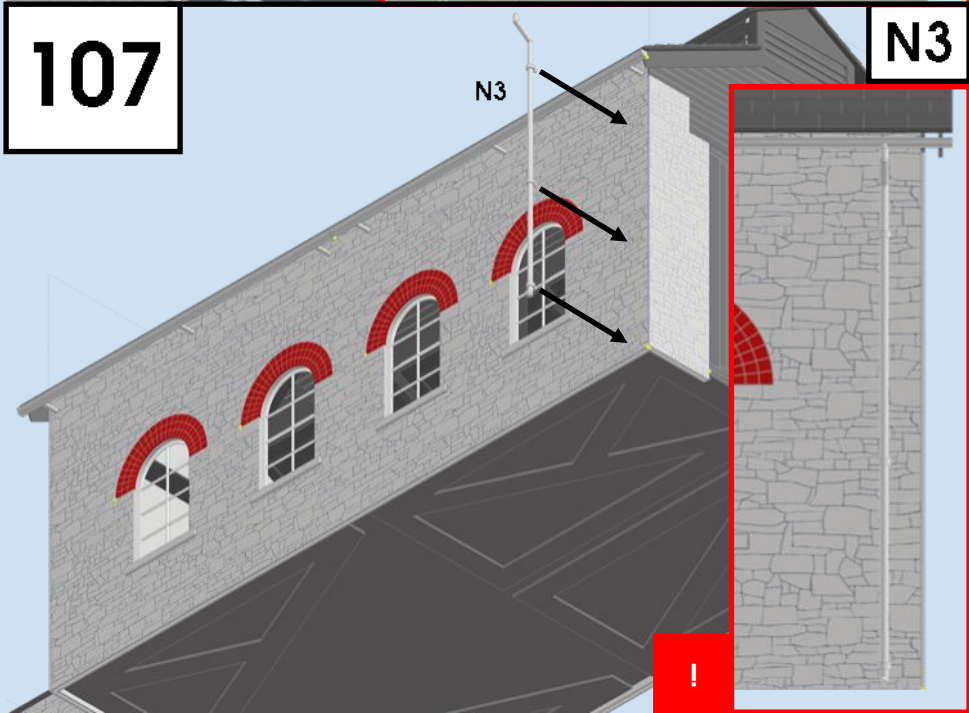

108

N5

N5

