

**7B-002-004 Instructions**  
**Part 2**

**53**

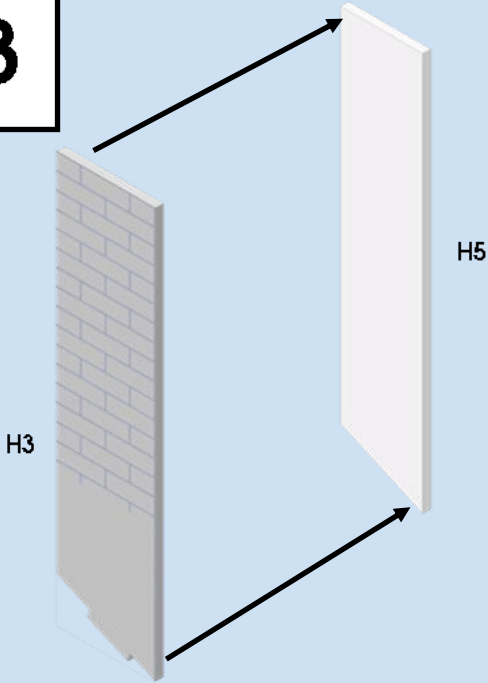

**H3 & H5**

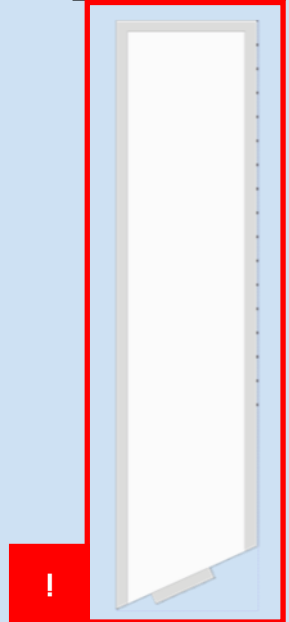

**54**

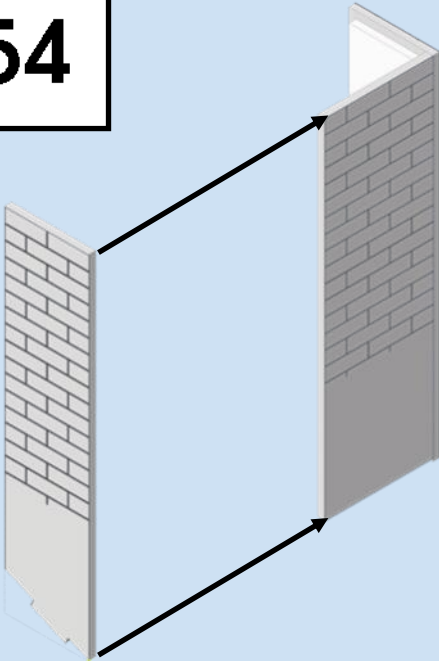

**55**

**H4**

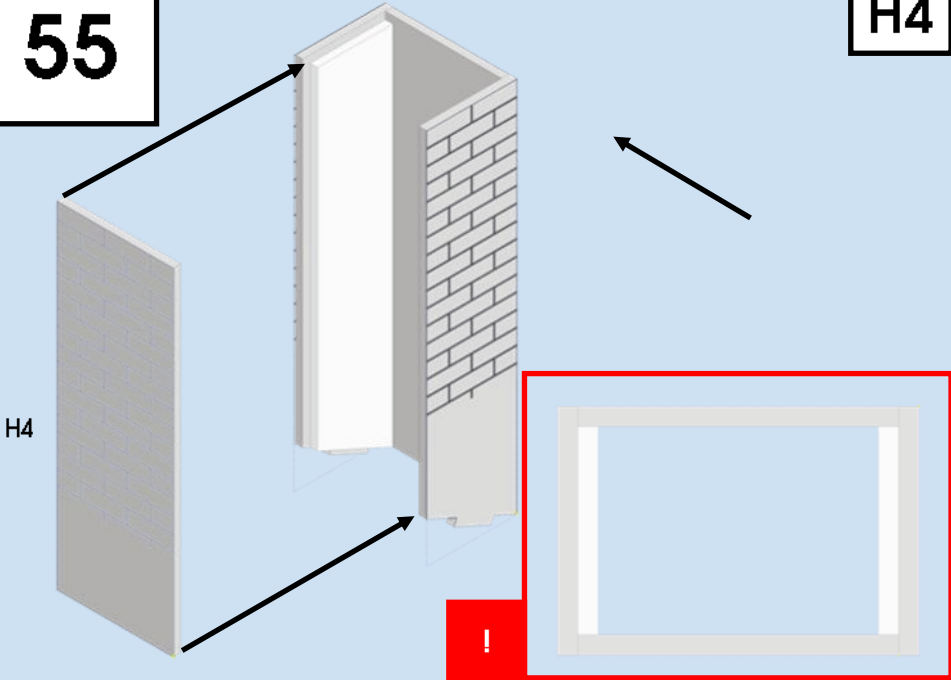

**56**

**H6**

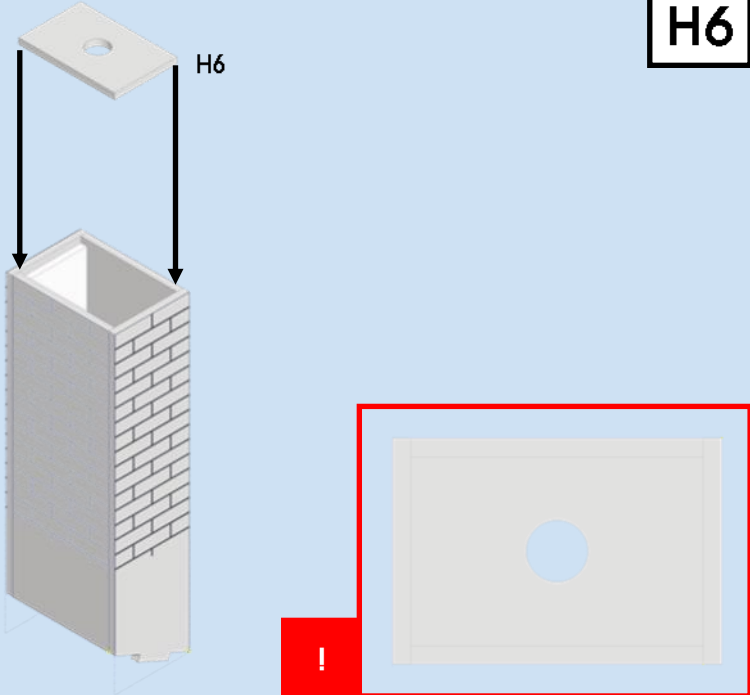

**57**

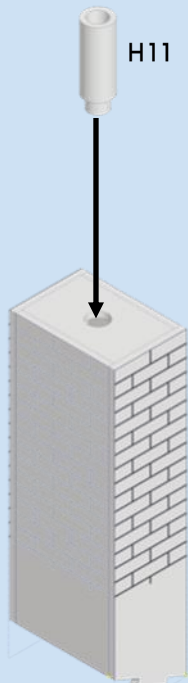

**H11**

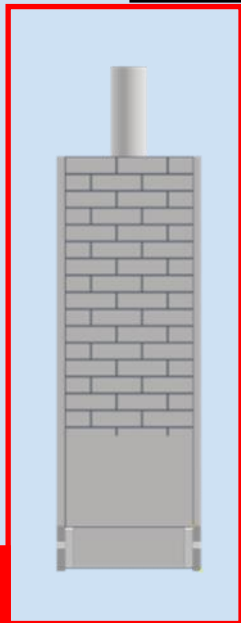

**58**

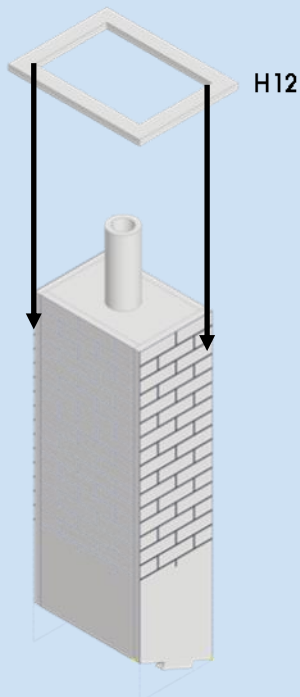

**H12**

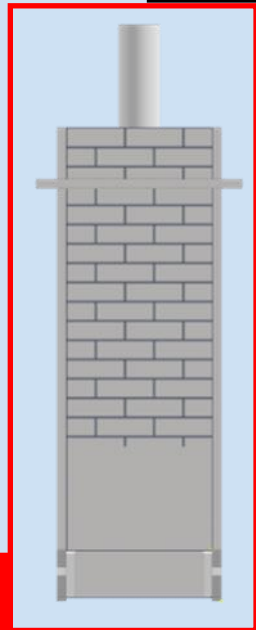

59

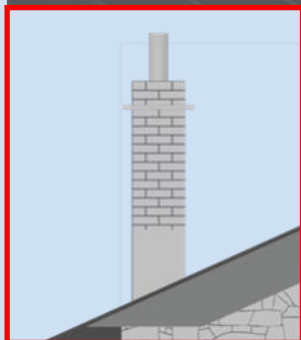
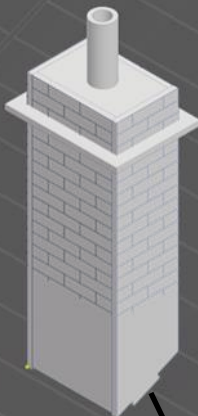

60

H7

H7

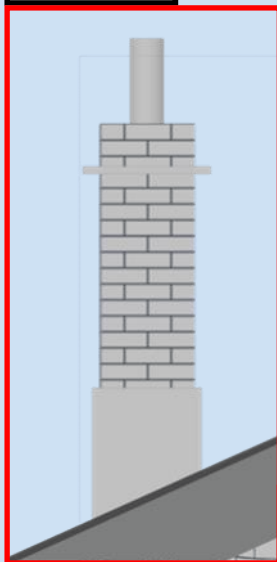
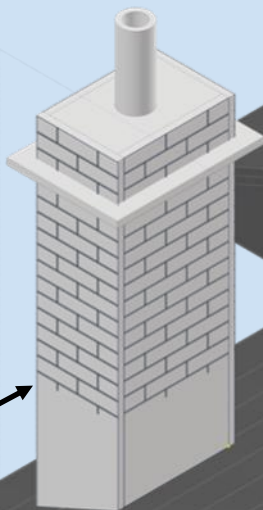

**61**

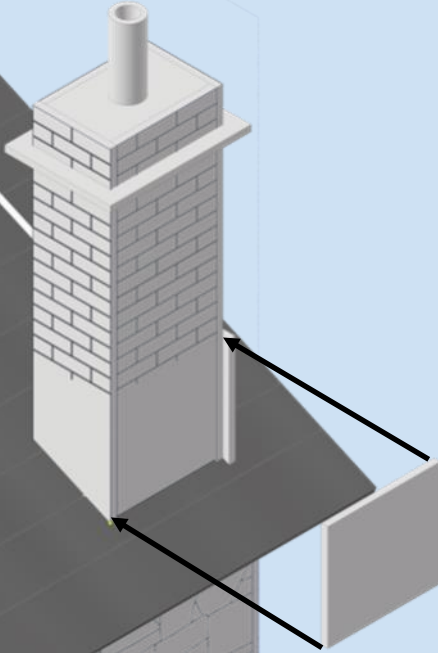

**H8**

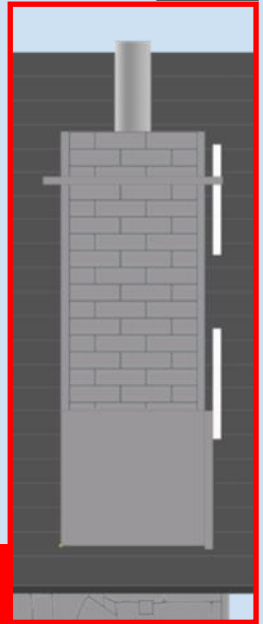

H8



**62**

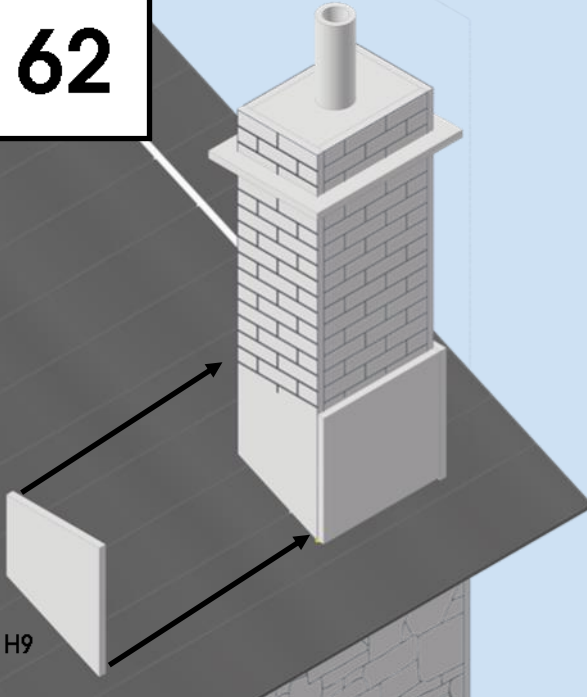

**H9**

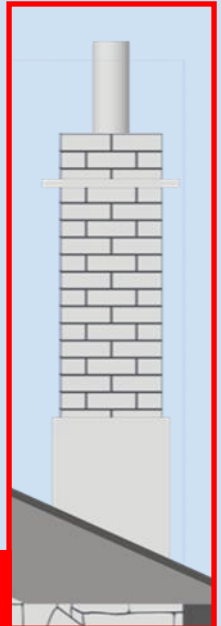

H9



63

!

H10

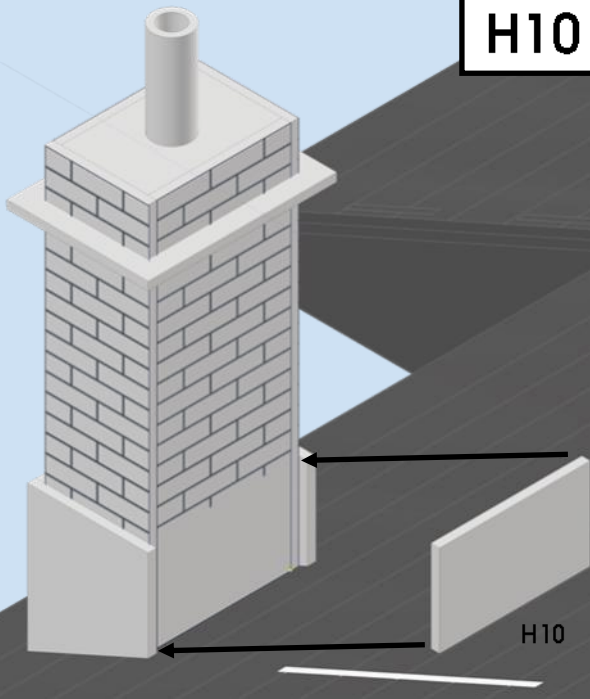
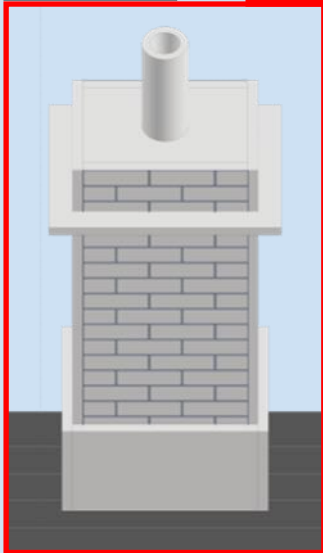

64

G3

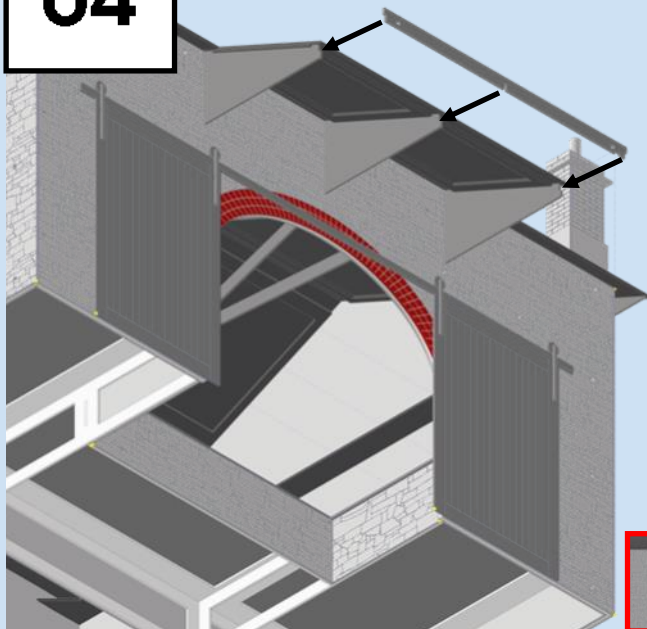

!



**65**

**F7 Tiles A**

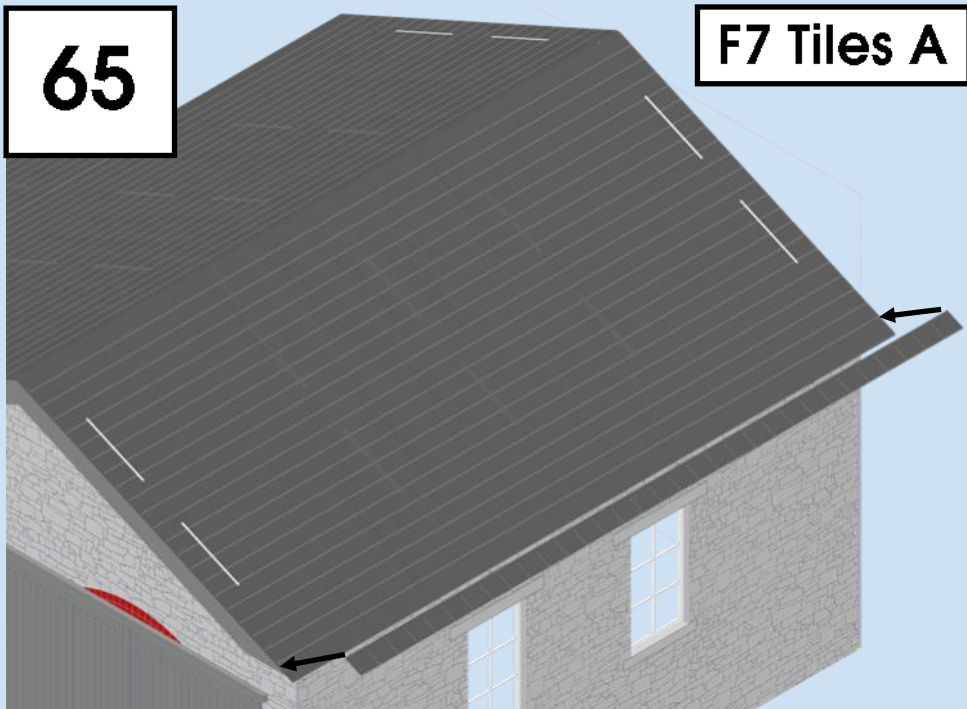

**66**

**F7 Tiles B**

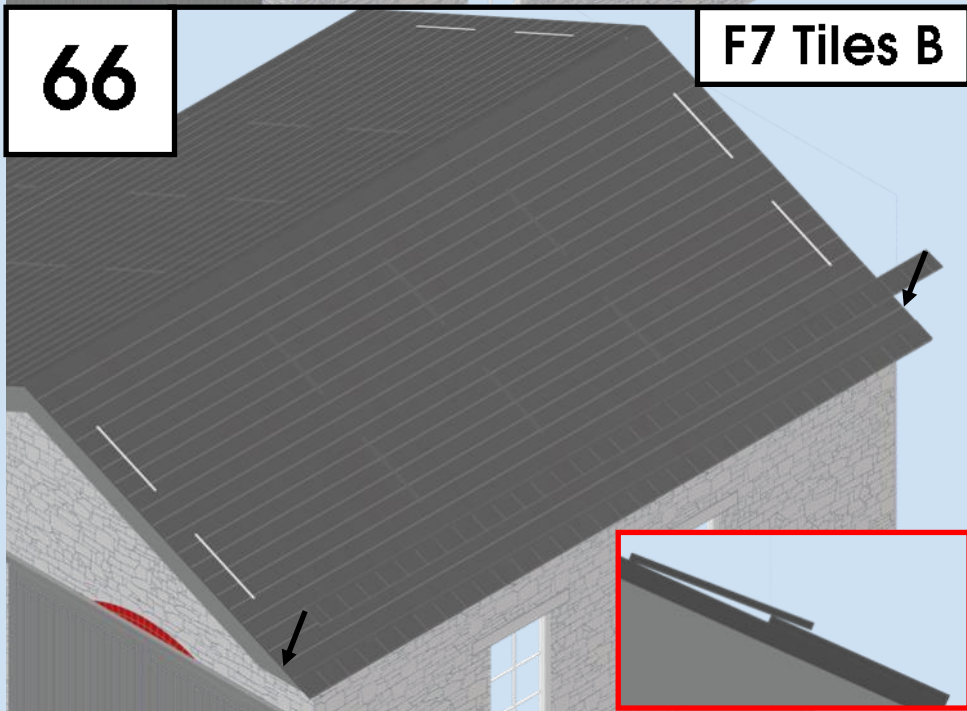



**67**

**Repeat with F7 Tiles**

**A<sub>(x10)</sub> & B<sub>(x10)</sub>**

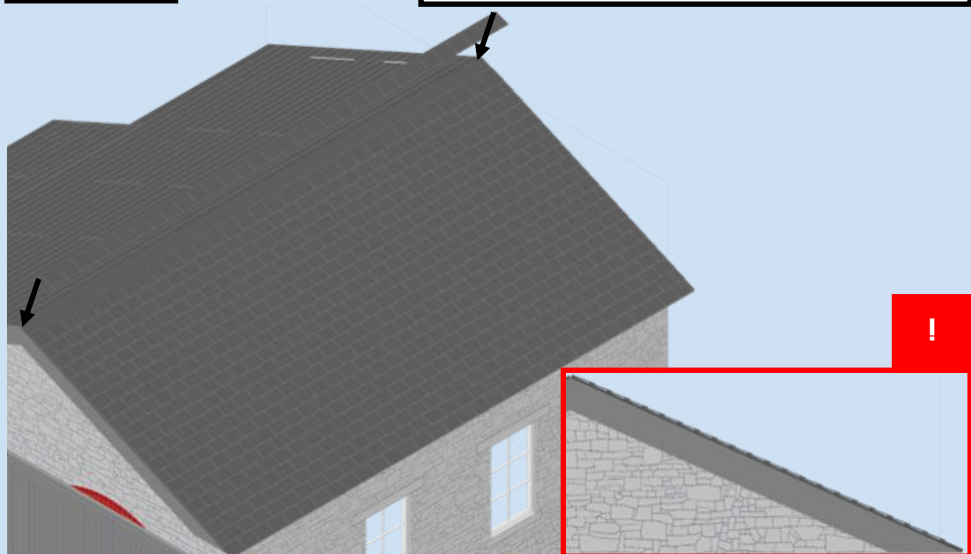

**68**

**G2 Tiles F**

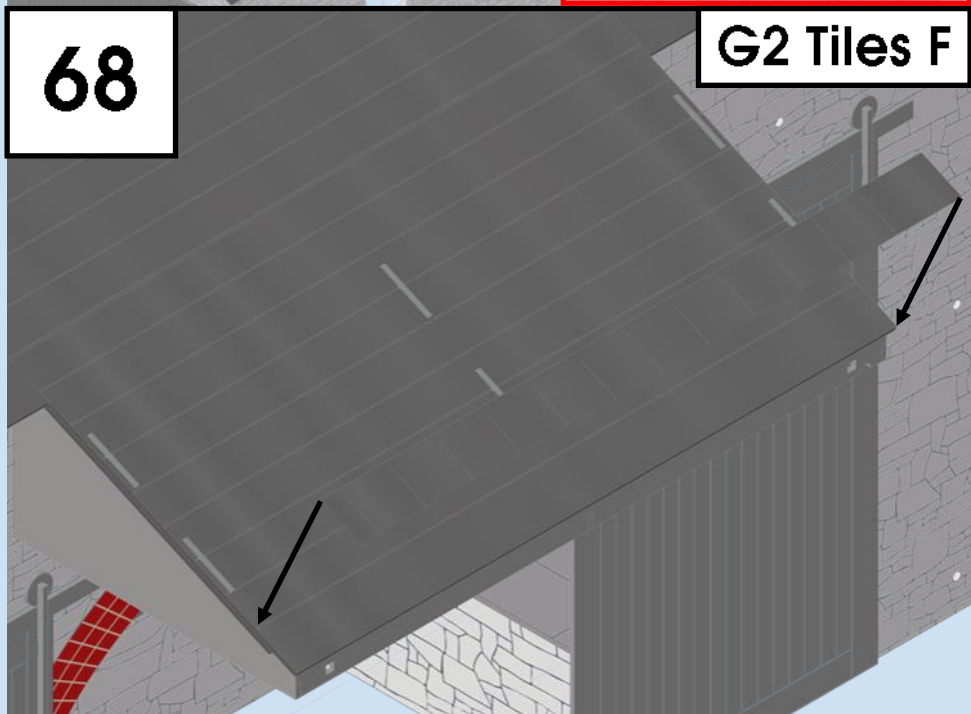

69

G2 Tiles G

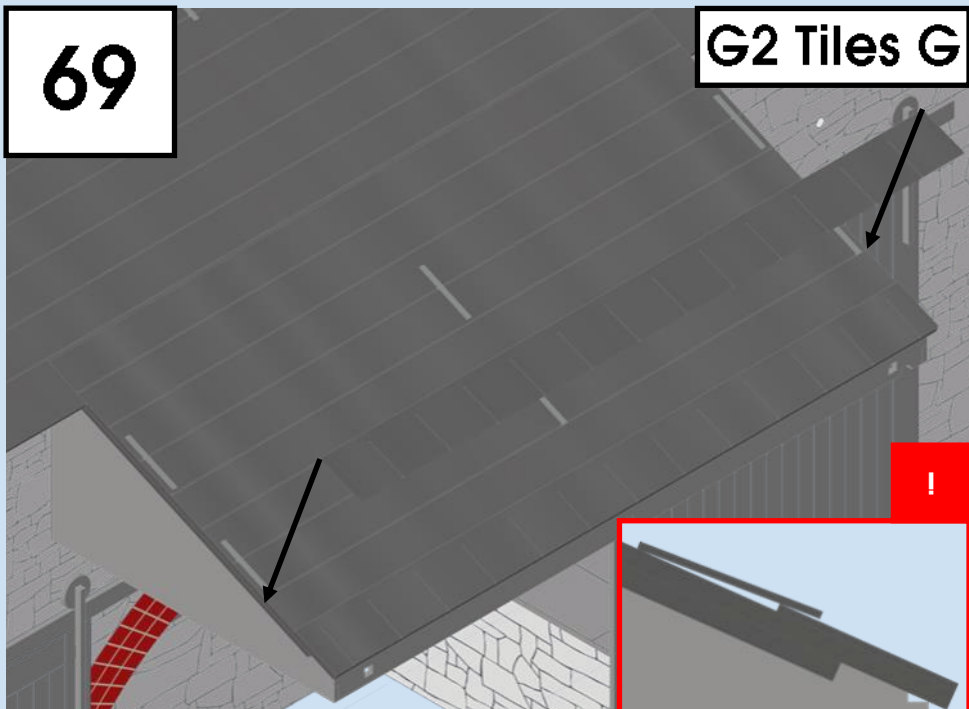

70

Repeat with G2 Tiles

G<sub>(x3)</sub> & F<sub>(x3)</sub>

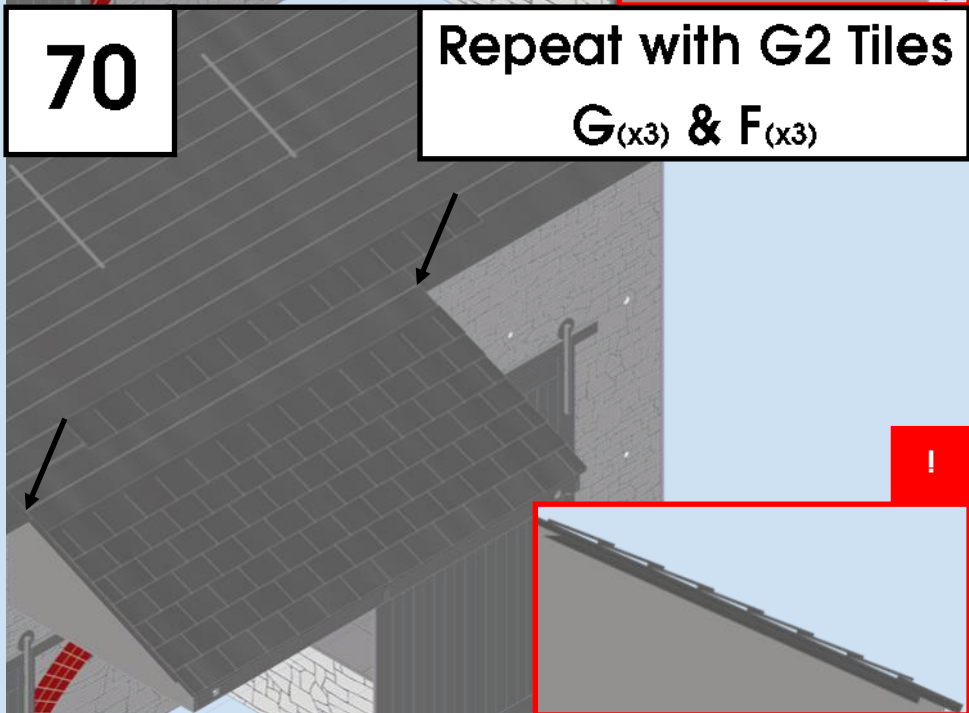

71

F6 Tiles A

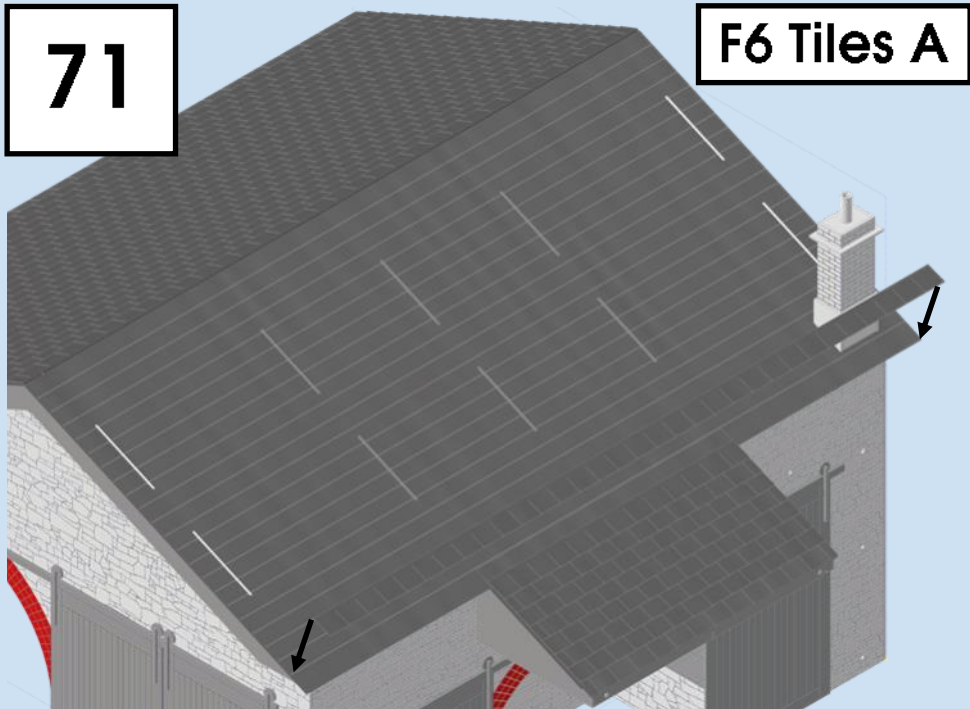

72

F6 Tiles C

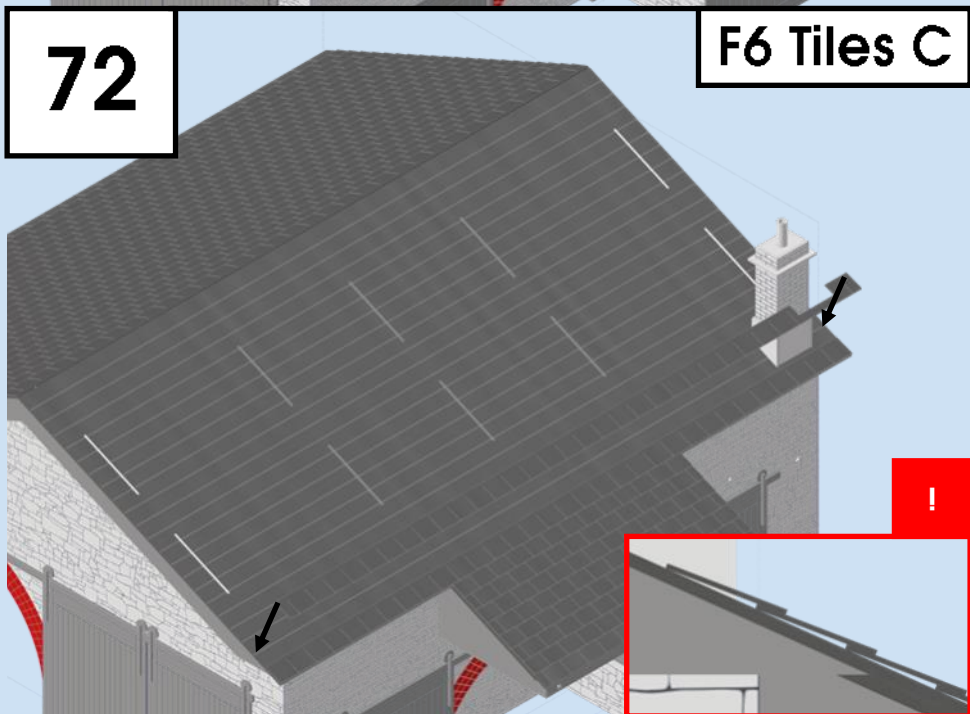

73

Repeat with F6 Tiles

D, E, A<sub>(x3)</sub> & B<sub>(x3)</sub>

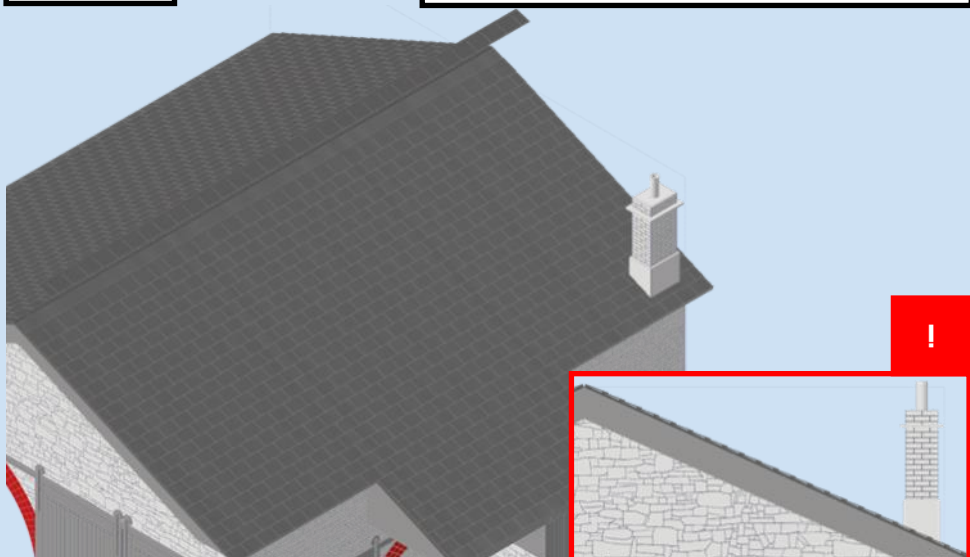

74

Fold Tile H

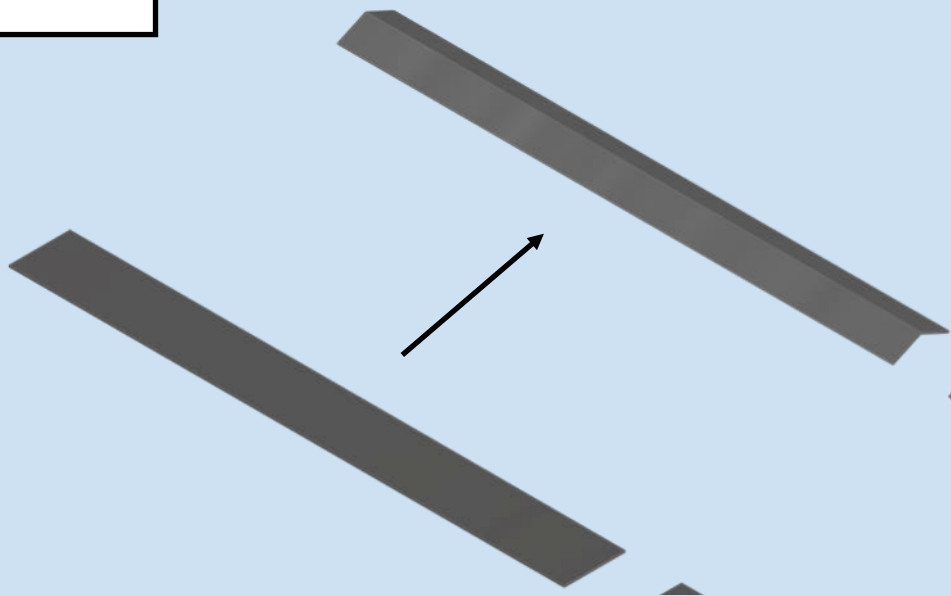

75

Tile H

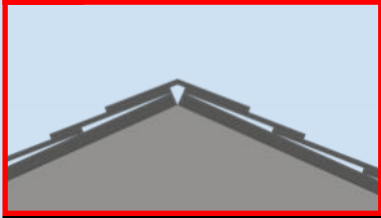
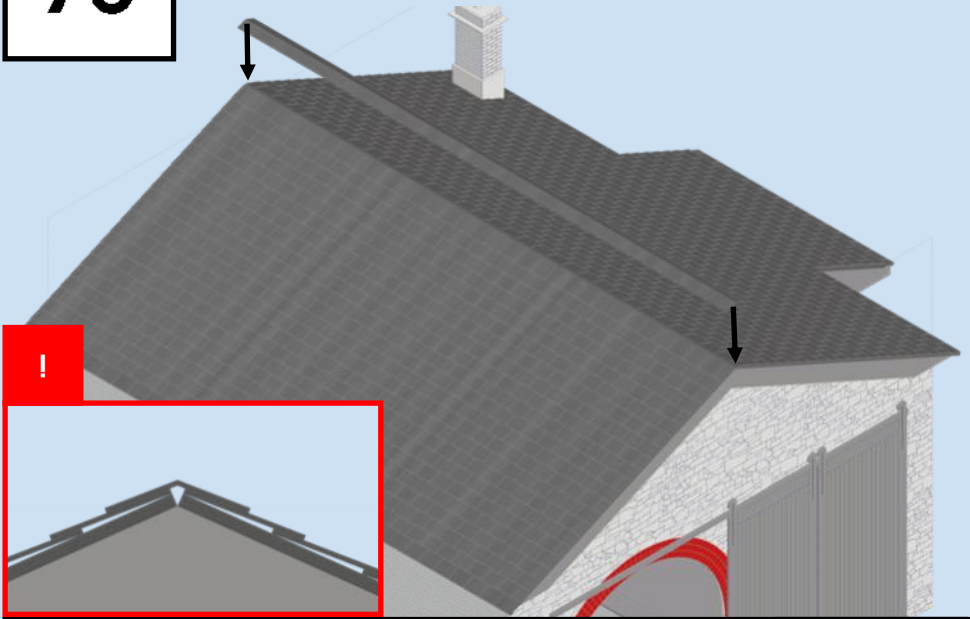

76

J1 & J2

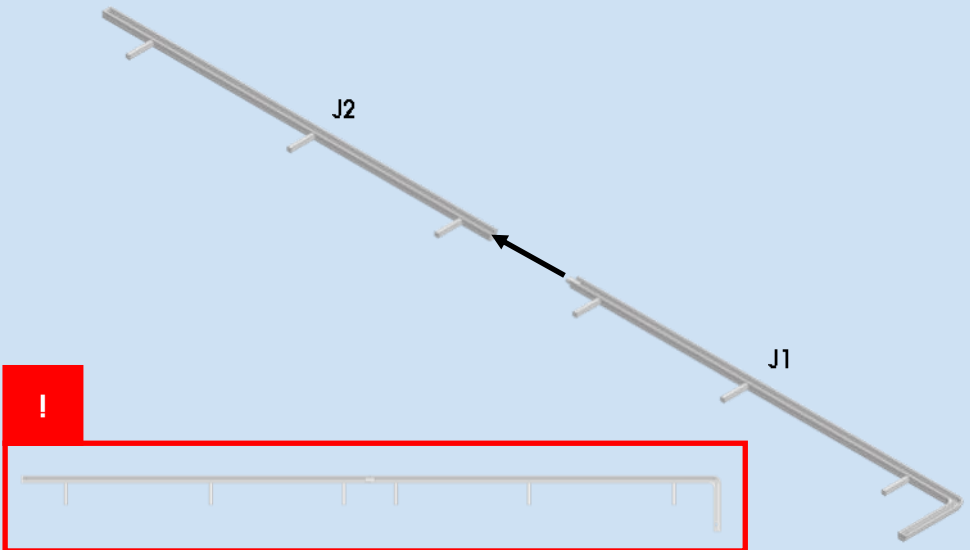

77

J1 & J2

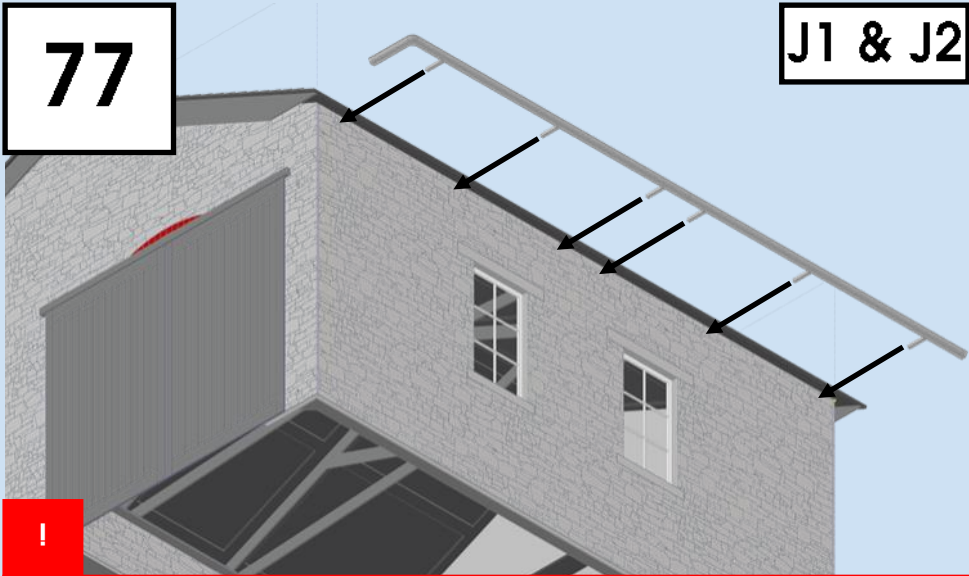

78

J3

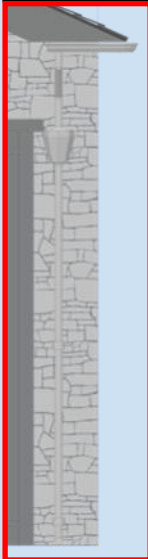
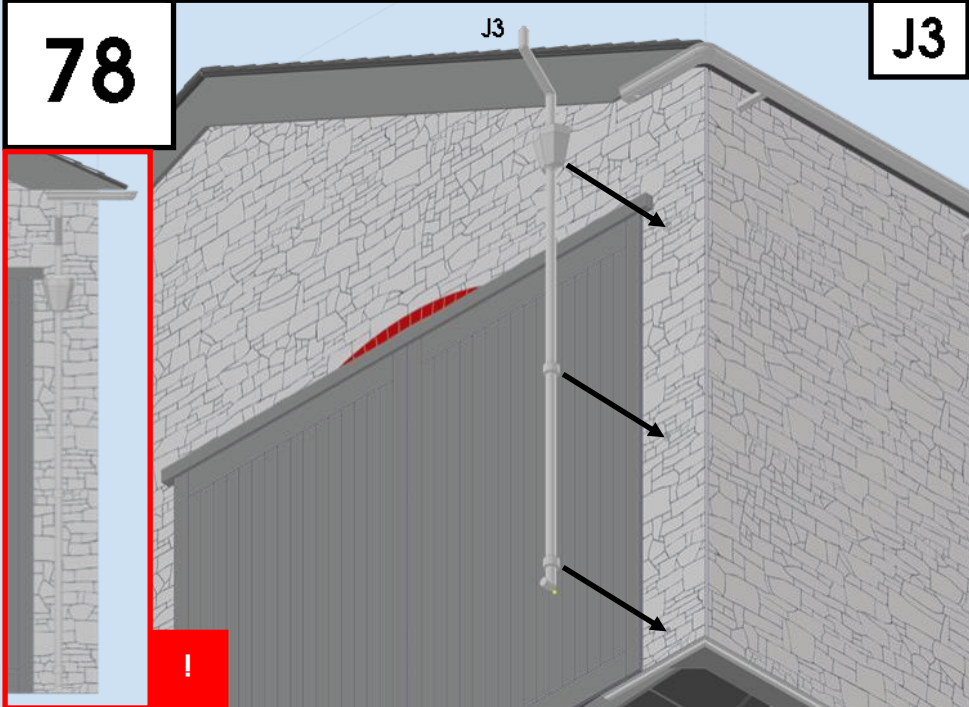



79

J4

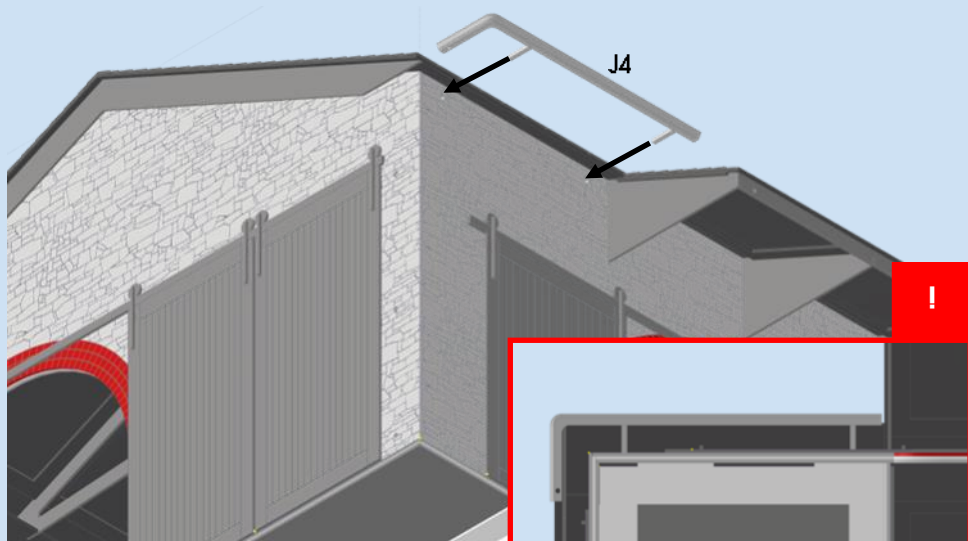

80

J3

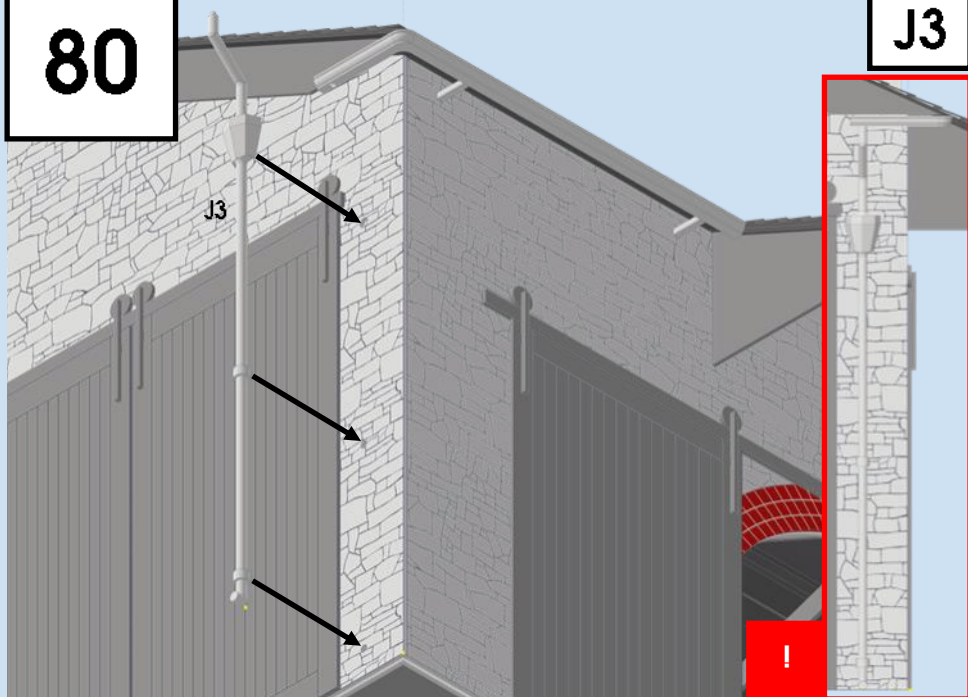

81

J5

J5

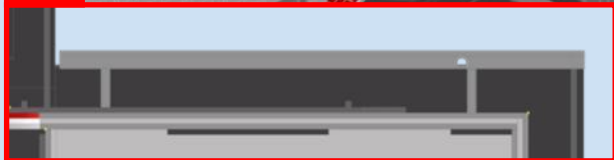

82

J6

J6

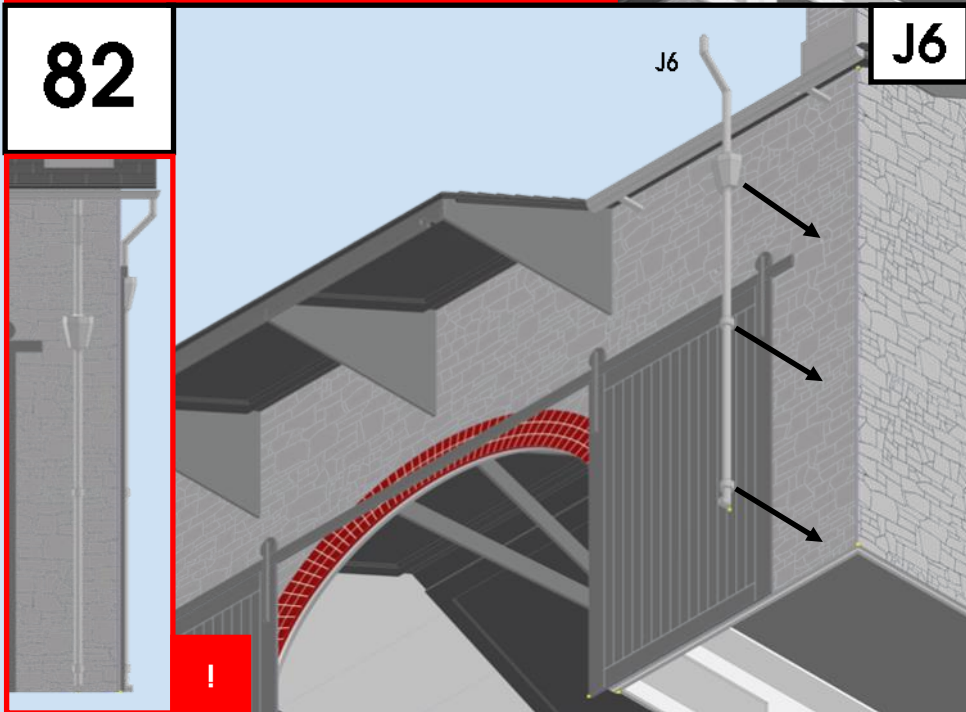



83

J7

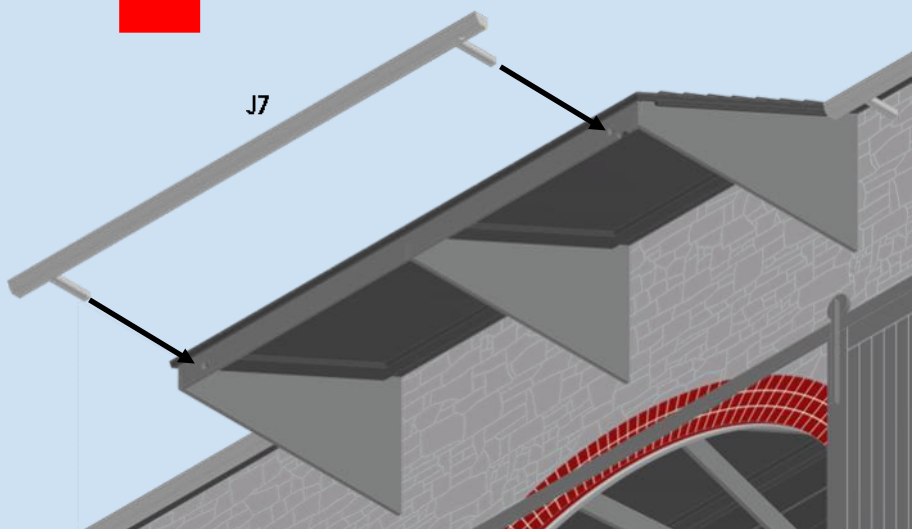

84

J8

