

dapol

O
Gauge



7B-001-001

Midland Railway Station Building

Based on Oakworth, K&WVR



Read Before Building

**Estimated Build Time:
20 Hours**

This is a very complex kit, we strongly recommend taking your time building it. It is also very important to keep a clean work area as the card is permeable and can stain very easily.

We recommend using a standard PVA glue slightly diluted with water. We do not recommend any fast drying glues, as they can dry too quickly, making any small positional adjustments difficult. It's best to apply glue using a small paintbrush of cardboard offcut.

Parts cannot be bought individually. Spare or replacement frets can be bought £10 each for large frets and £7 each for small frets by contacting sales@dapol.co.uk

Printed instructions are available free of charge by contacting sales@dapol.co.uk

But most of all. Enjoy.

Checklist

- Clear 4

- ■(x4)
- ●(x4)
- ★(x2)
- ▲
- +
- ◆

Scarlet 9

- 2G1 (x2)
- 2G2 (x2)
- 2G3 (x2)

Slate 11

- 1F1
- 1F2

Slate 12

- 1F3 (x2)
- 2F1
- 2F3 (x2)
- 4D1
- 6J1
- 6J2

Slate 13

- 1F4 (x2)
- 2F2
- 4C2
- 5A2
- 6J2

Slate 14

- 3F1
- 3F3
- 3F4
- 5F1 (x2)
- 5F2 (x2)
- 5H1 (x2)

Slate 15

- 3F2
- 3G1
- 6C2
- 6J3 (x2)

Slate Thin 6

- Tiles for 1F1
- Tiles for 1F2

Slate Thin 7

- Tiles for 2F1

Slate Thin 8

- Tiles for 2F2

Slate Thin 9

- Tiles for 3F1

Slate Thin 10

- Tiles for 3F2

Slate Thin 11

- Tiles for 5F1

- Tiles for 5F1

- Tiles for 6J1

- Ridge Tiles

Stone 5

- 1A1
- 1E1
- 1E2
- 1E4
- 1E5
- 1E6
- 1E7
- 1E8
- 1E9
- 1E10
- 1E12

Stone 6

- 1B1
- 1E3
- 1G1 (x2)
- 2E3 (x2)

Stone 7

- 1C1
- 1E1
- 1E2
- 1E4
- 1E5
- 1E6
- 1E7
- 1E8
- 1E9
- 1E10
- 1E12

- 2G8

Stone 8

- 1D1
- 1E3
- 1G1 (x2)
- 2E3 (x2)

Stone 9

- 1E11 (x2)
- 2B1
- 2E5
- 2G4 (x4)

Stone 10

- 2A1
- 2C2

Stone 11

- 2E1 (x2)
- 2E2 (x2)
- 2E4 (x4)
- 2E6 (x2)
- 2E7 (x2)
- 2E8 (x2)

Stone 12

- 3A1
- 3C1

Stone 13

- 3B1
- 3E5
- 3E6
- 3G3 (x4)
- 3G4 (x2)
- 3G6 (x2)
- 3G7
- 3G9 (x2)
- 3G10

Stone 14

- 4A1
- 4B1
- 4C1
- 5A1
- 5B1
- 5C1
- 5D1
- 5E1
- 5G2 (x2)

- 5G3

Stone 15

- 6A1
- 6B1
- 6C1
- 6E1
- 6F1
- 6G1
- 6H1
- 6H2

Stone 16

- 6D1
- 6D2 (x2)
- 6D3 (x3)
- 6H3
- 7A1 (x4)
- 7A2 (x3)
- 7A3
- 7B1 (x4)
- 7B2 (x4)

White 10

- 1G2 (x4)
- 2G5 (x4)
- 2G9 (x4)
- 3G2 (x2)
- 3G5
- 3G8
- 5G1
- 6G2 (x3)
- 6H4

White 11

- 4B2
- 6A2
- 6B2
- 7B3 (x4)

White 13

- 4A2
- 5B2
- 5E2
- 6E2
- 5J1

1

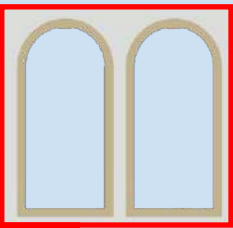

!

1A1 & 1A2

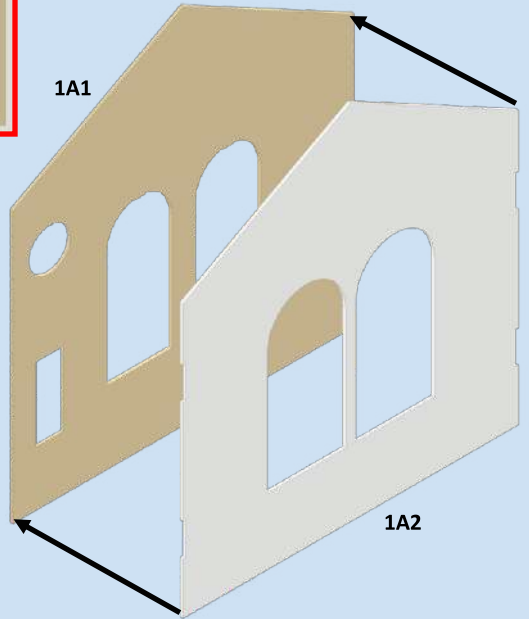

2

1E1, 1E2 & 1E3

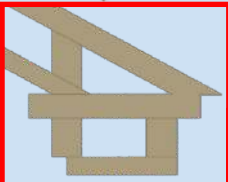
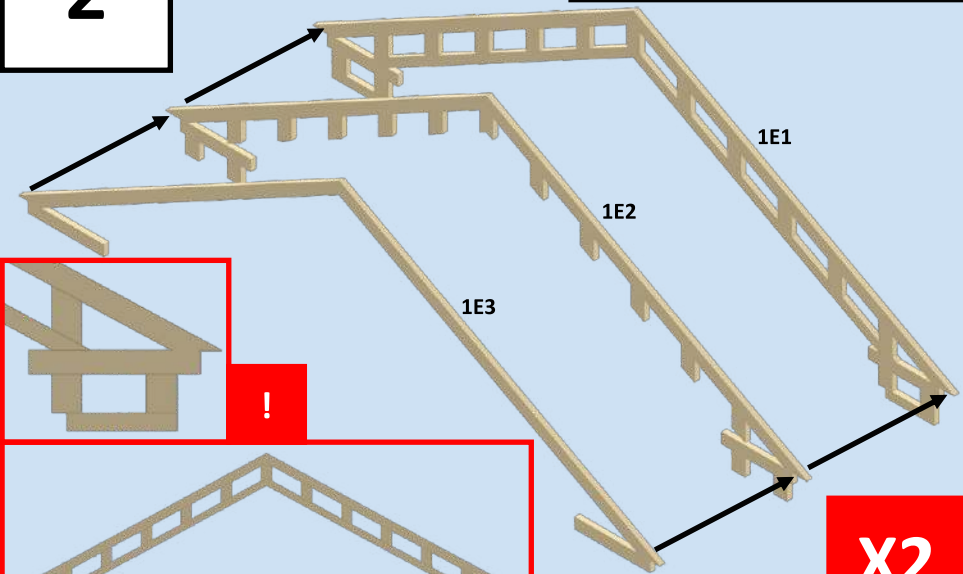

!

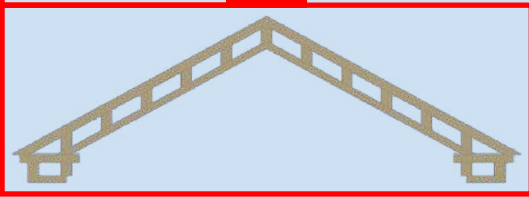

X2

3

!

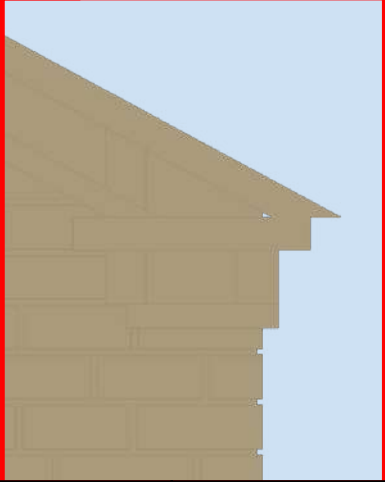
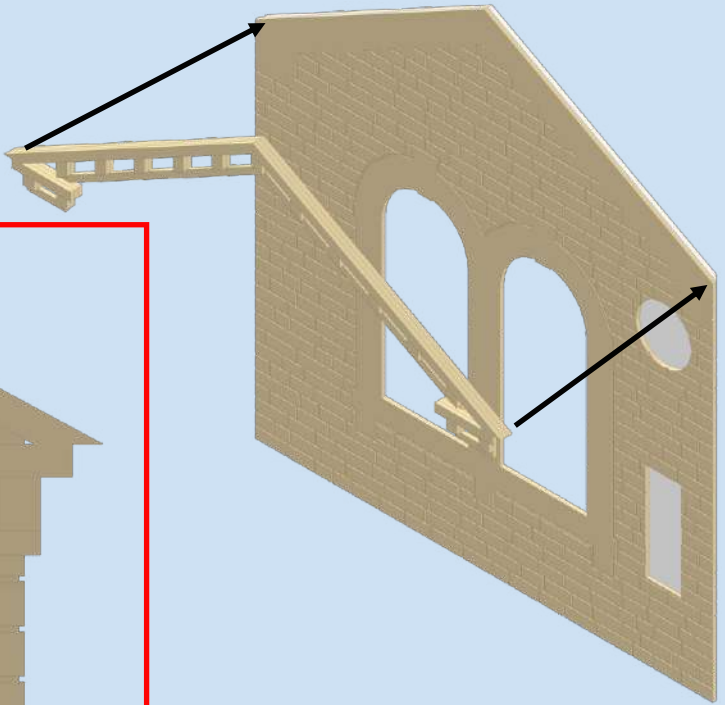

4

1E10, 1E11 & 1E12

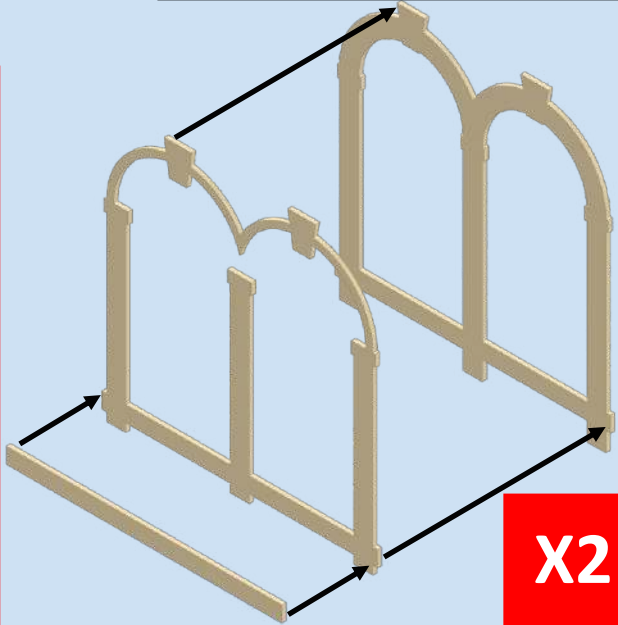
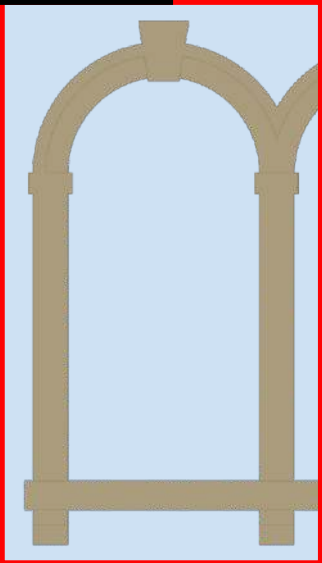

X2

5

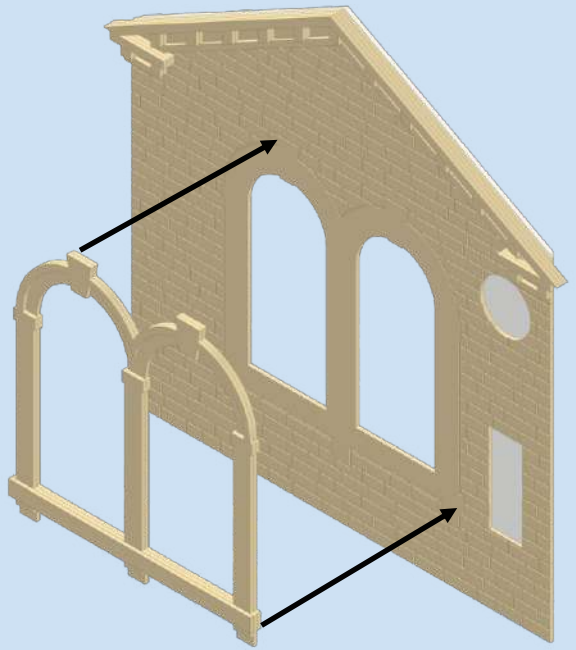

!

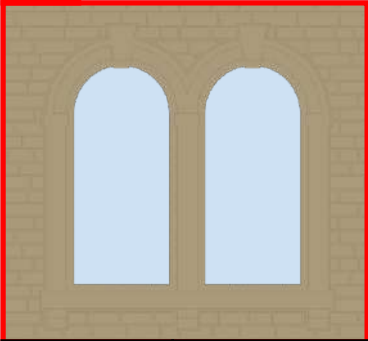

6

■ , 1G1 & 1G2

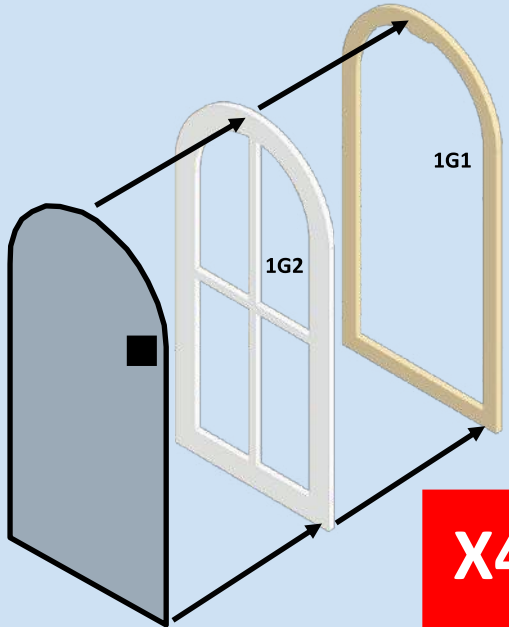

1G1

1G2

X4

!

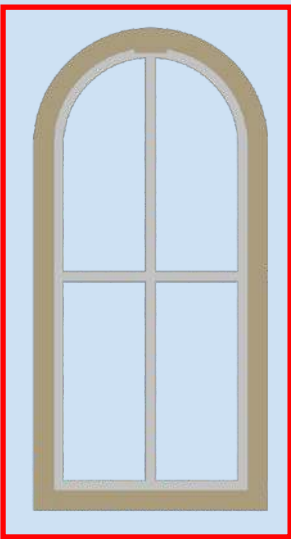

7

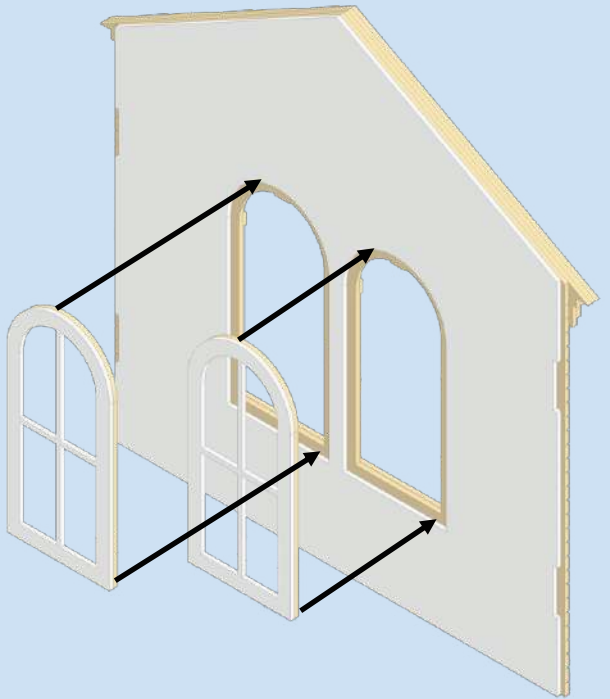
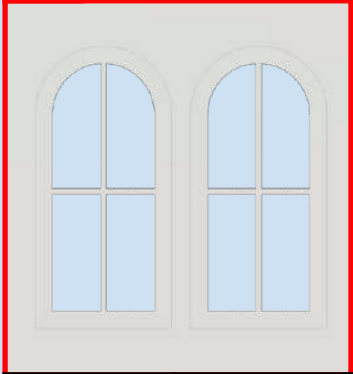

8

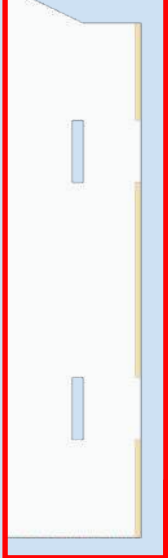

1B1 & 1B2

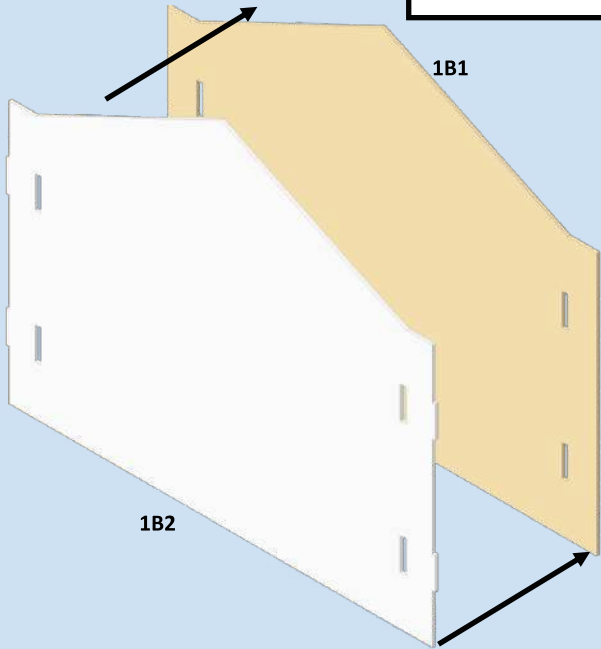

9

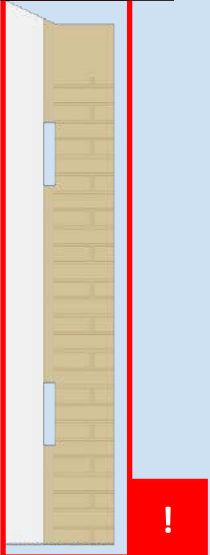

2D1

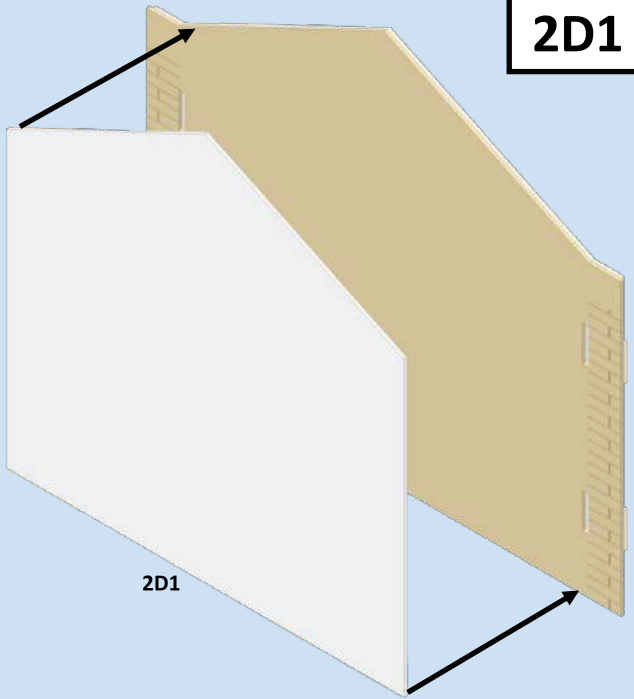

10

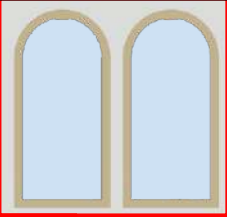
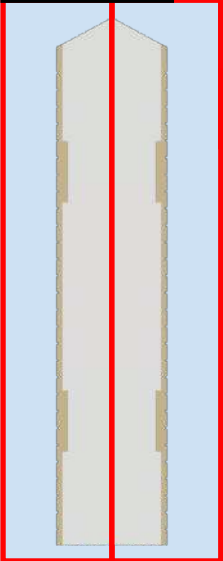

1C1 & 1C2

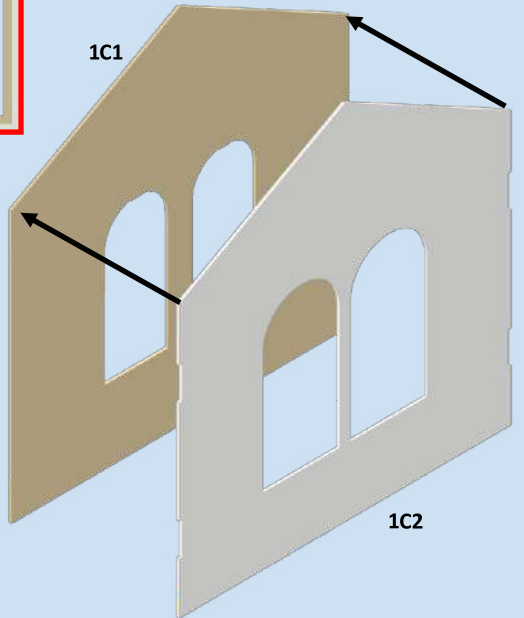

11

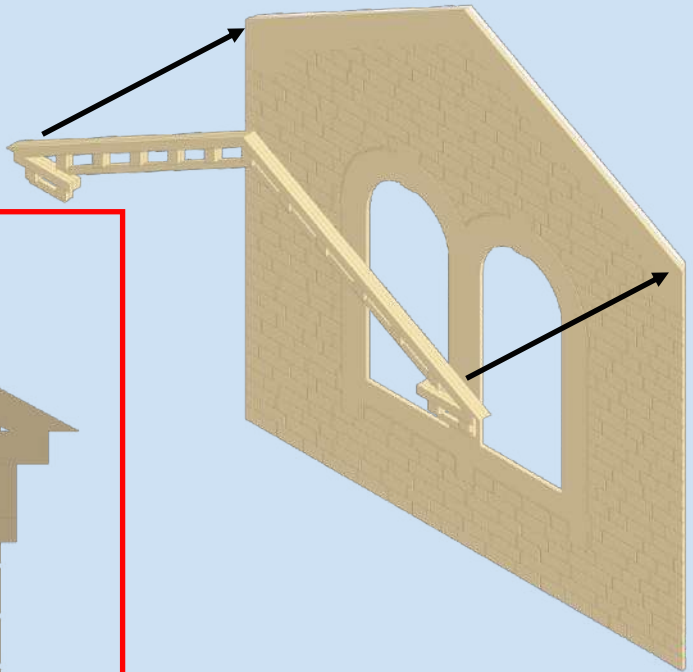
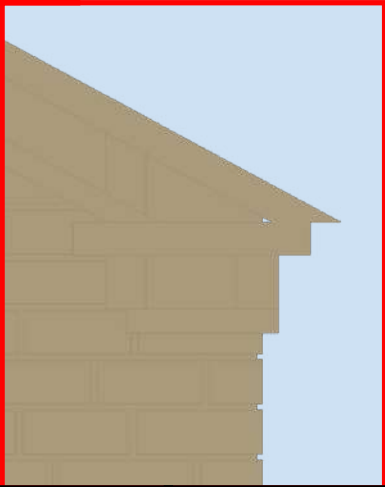

12

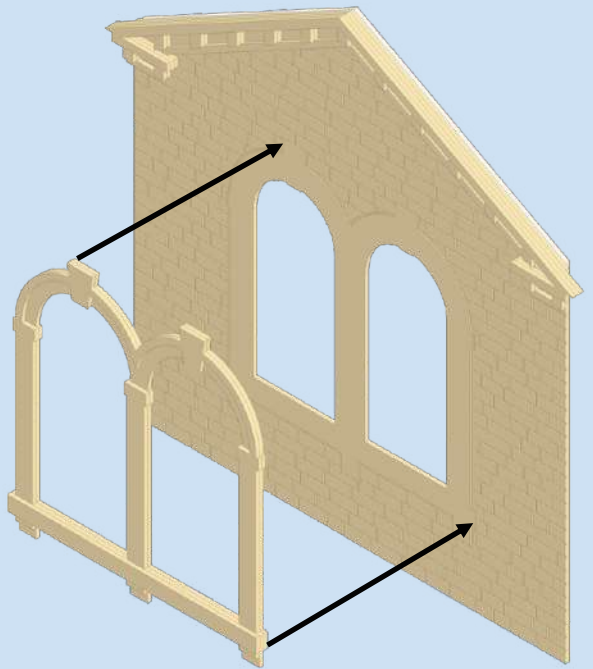
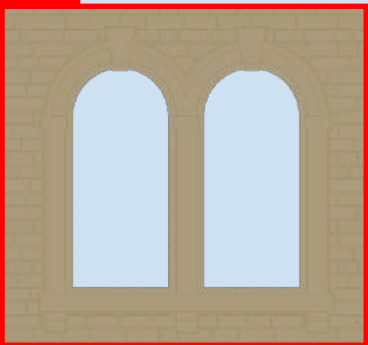

13

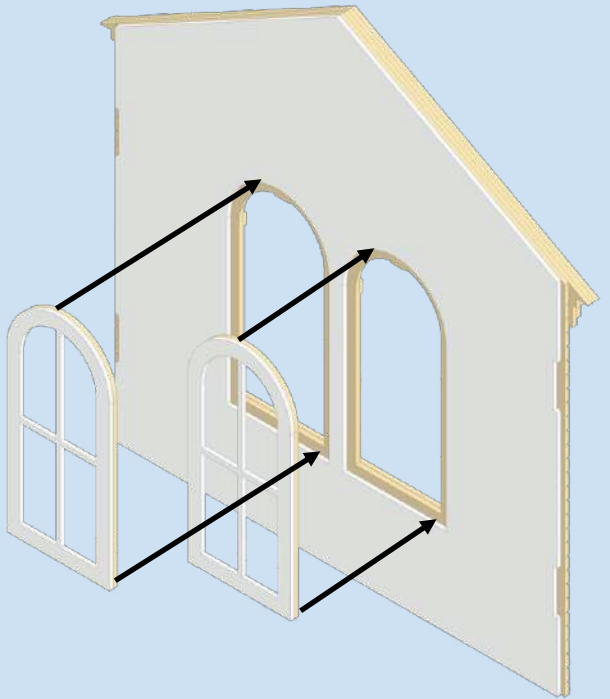
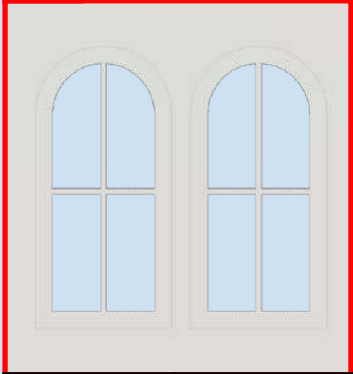

14



1D1 & 1D2

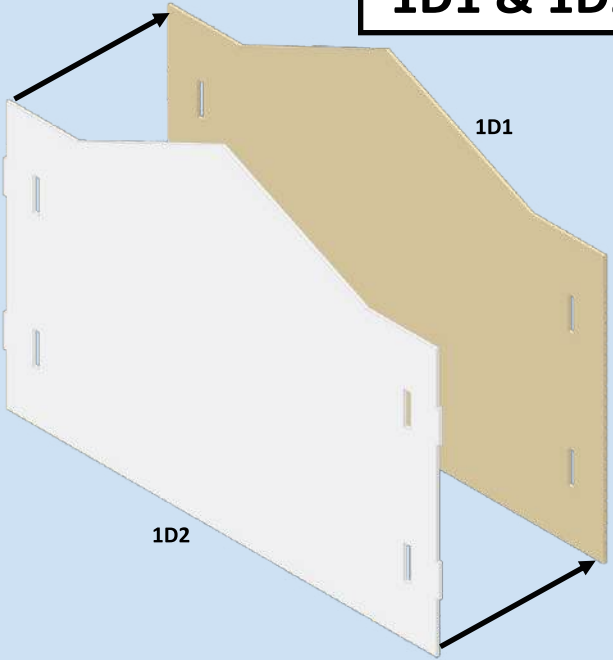

15

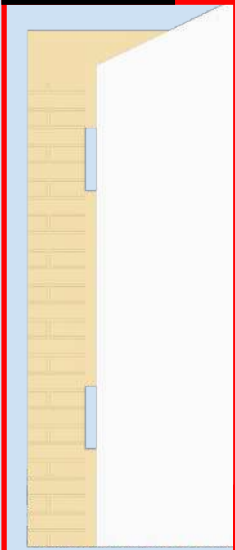

3D1

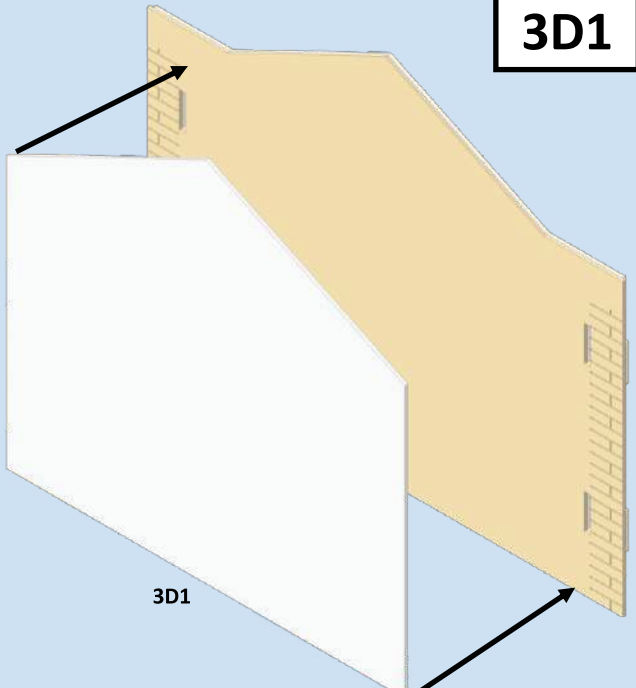

16

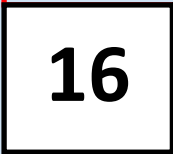

1A & 1B

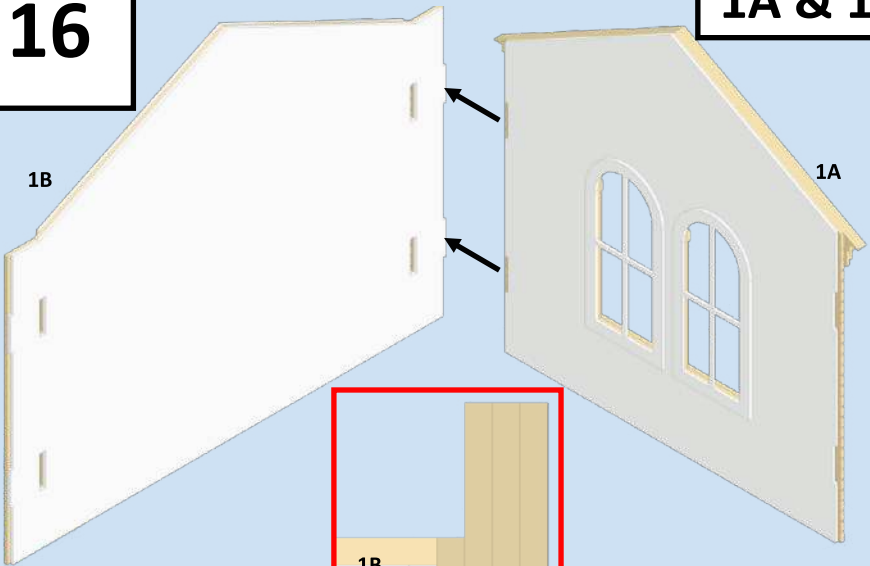

1B

1A

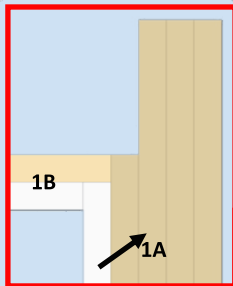

17

1AB & 1C

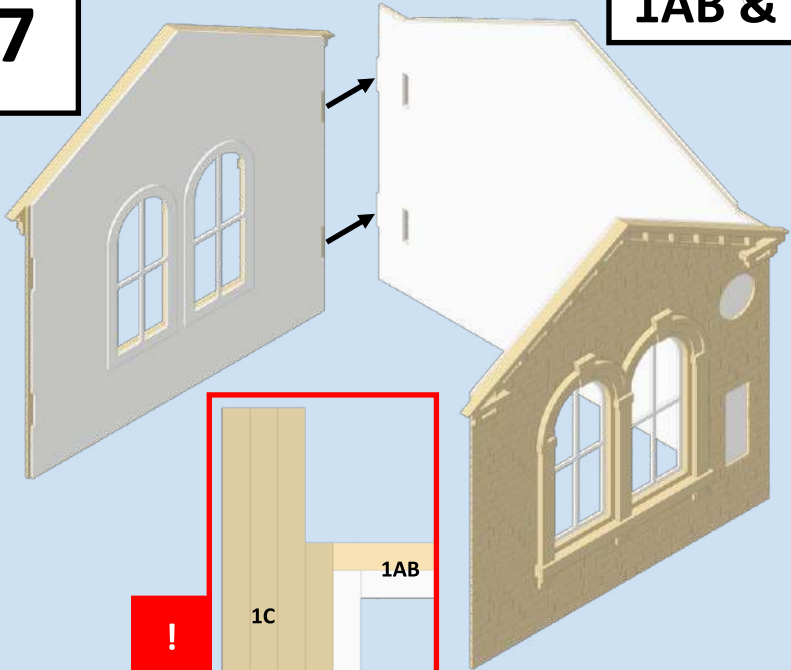

18

1ABC & 1D

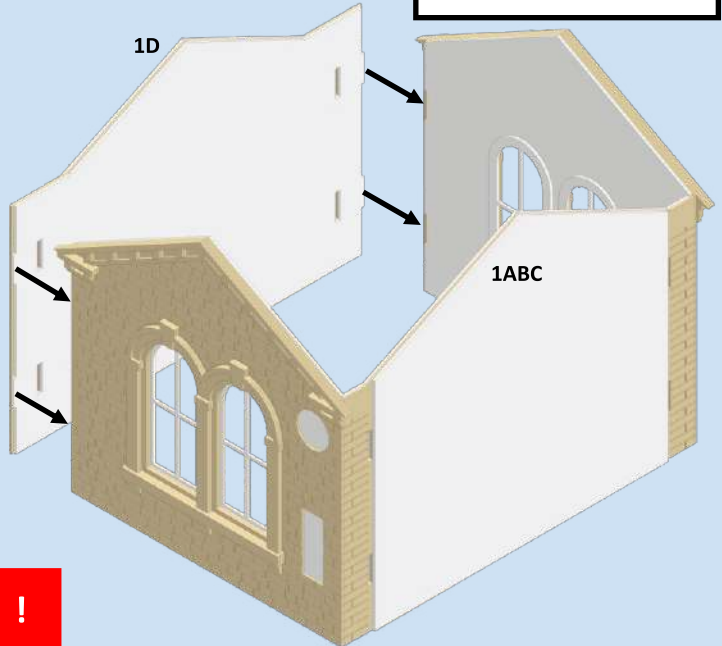
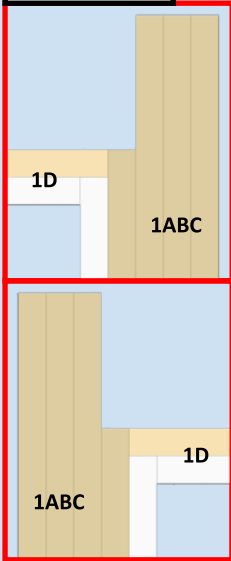

19

3A1 & 3A2

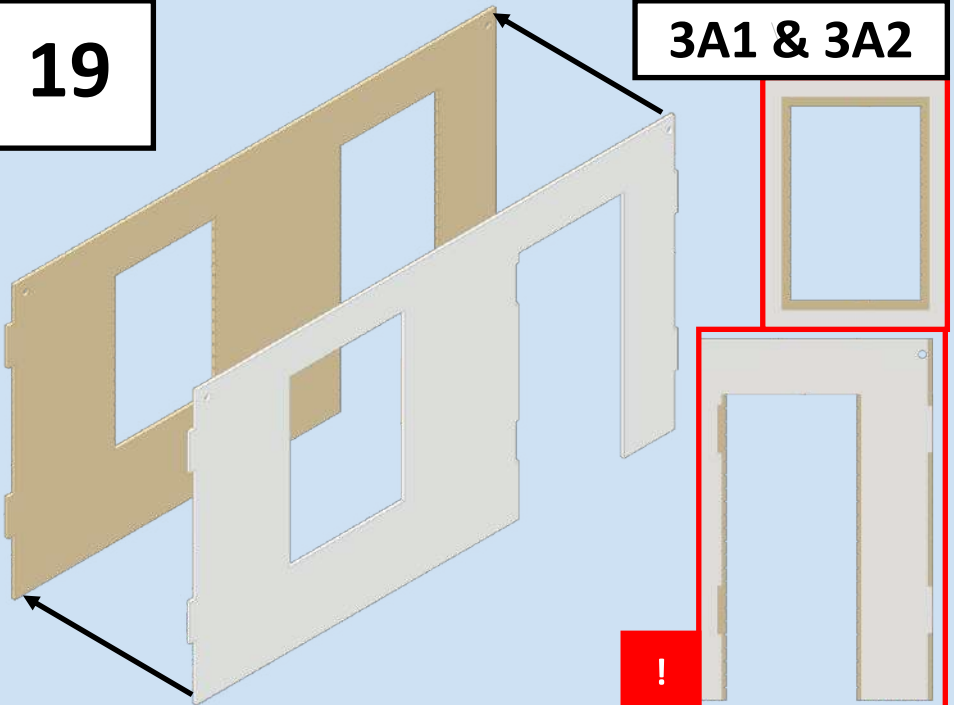

20

★ , 3G2 & 3G3(x2)

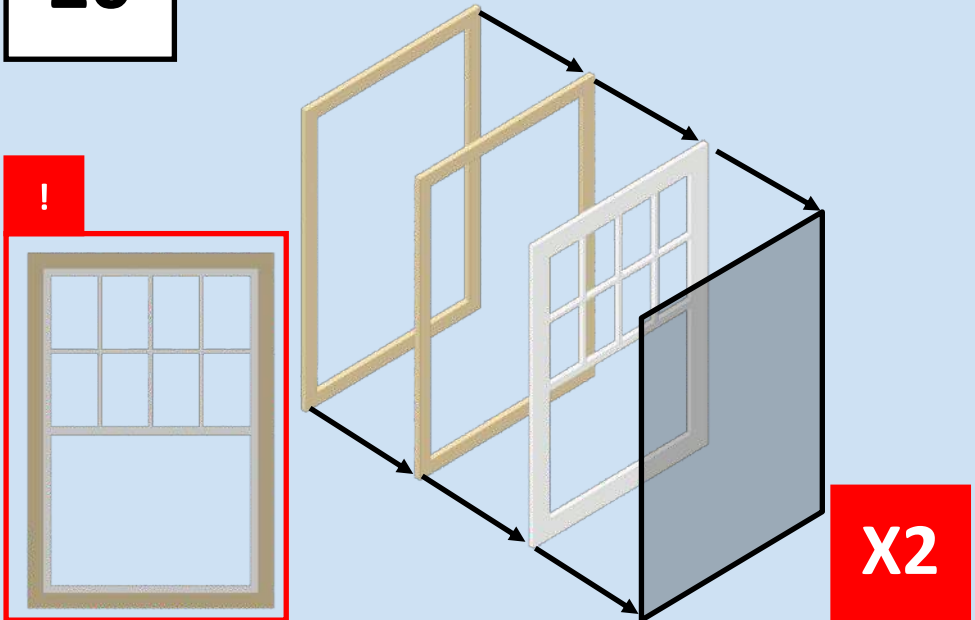

21

!

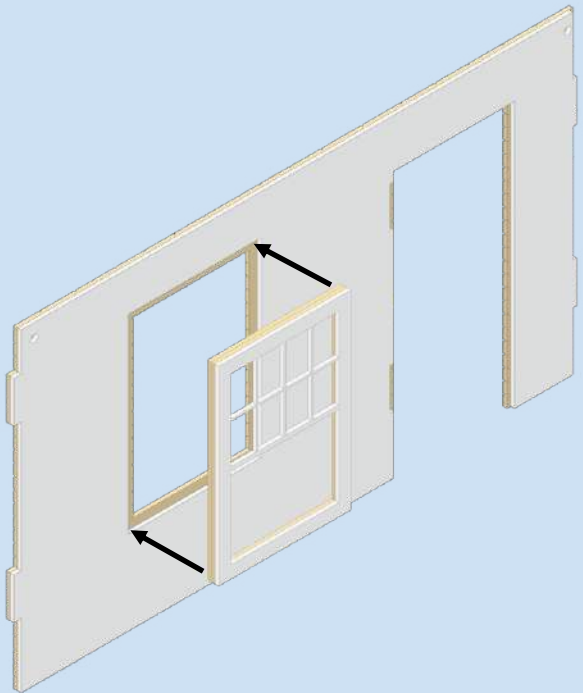
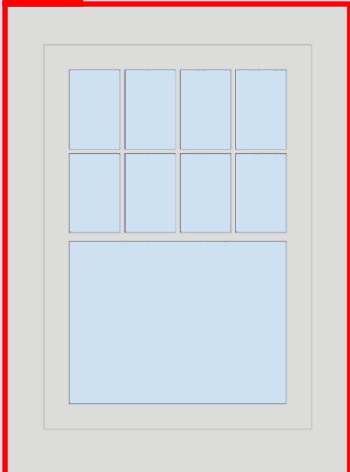

22

3G4

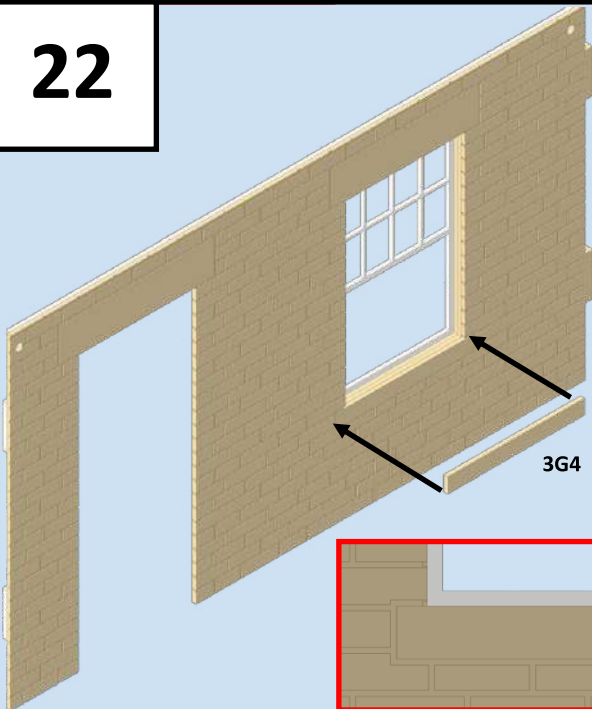

!

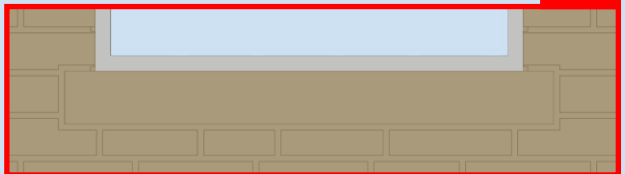

23

3B1 & 3B2

3B1

3B2

!

24

+ , 3G8 & 3G9(x2)

3G9

3G9

3G8

+

25

!

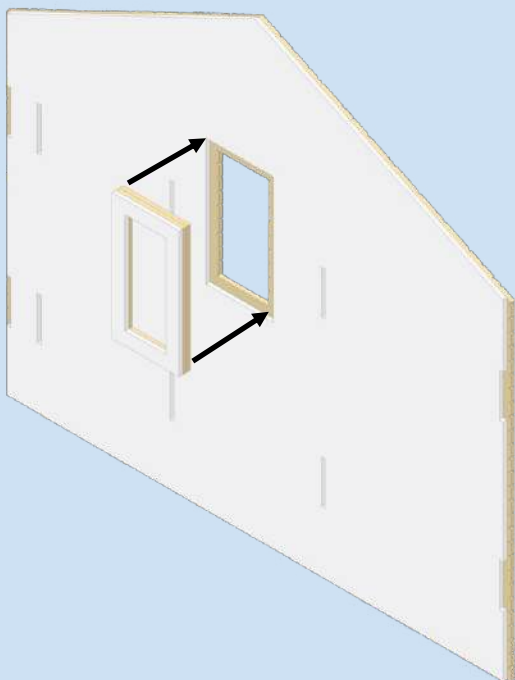
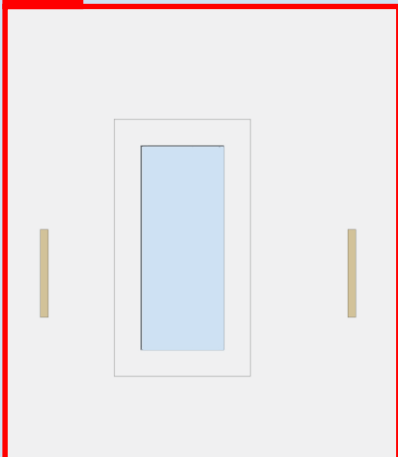

26

!

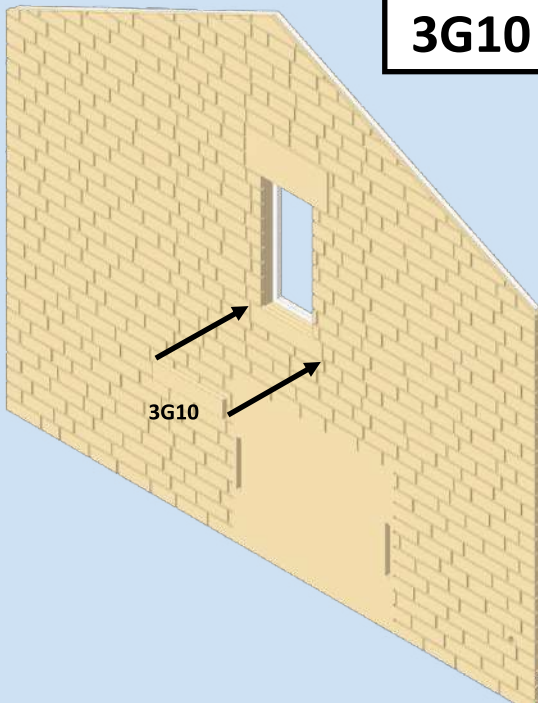
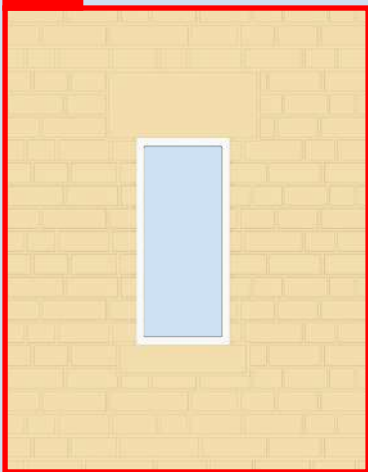

3G10

3G10

27

3C1 & 3C2

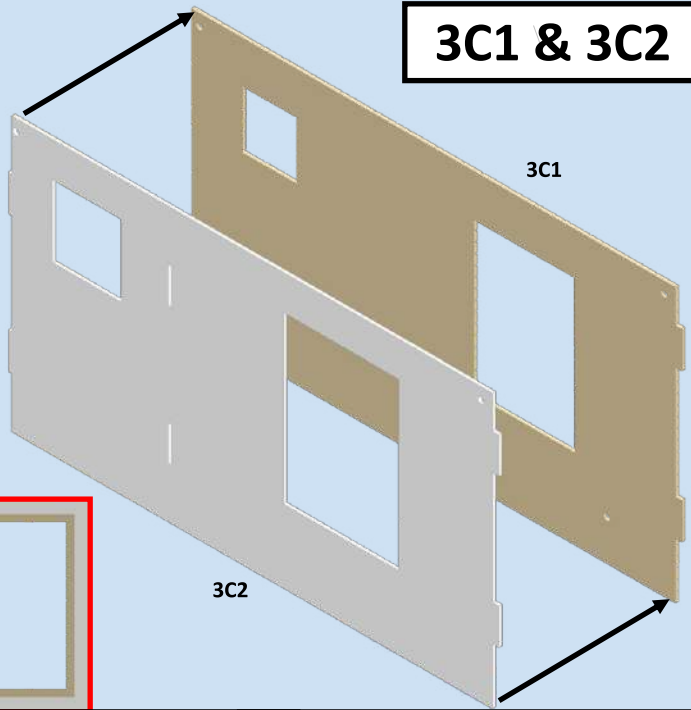
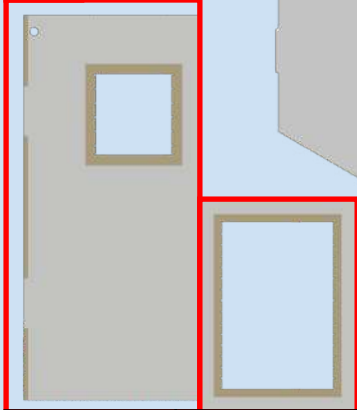

28

3G5 & 3G6(x2)

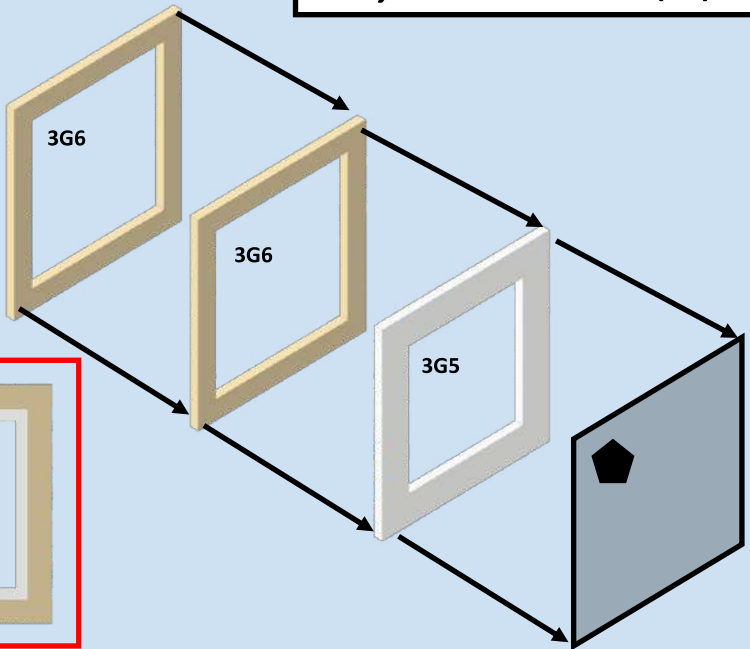
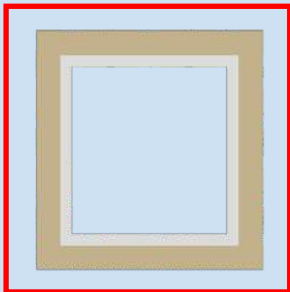

29

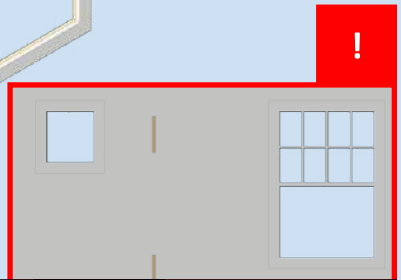
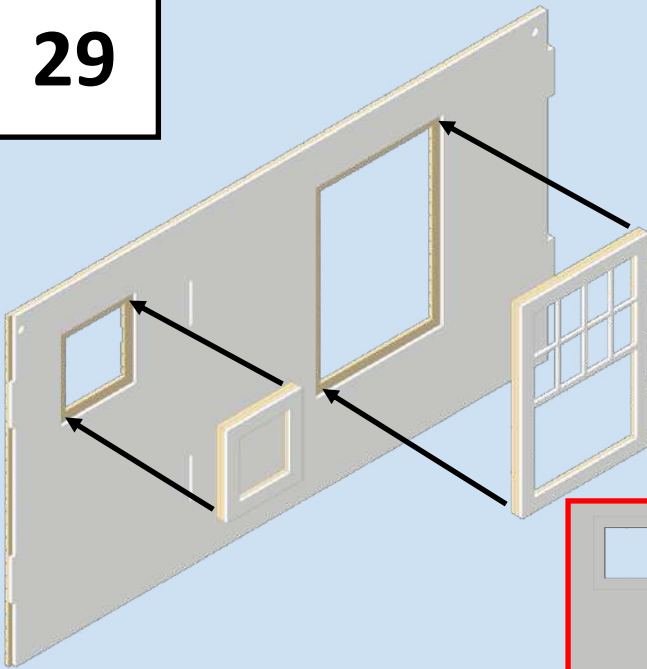

30

3G4 & 3G7

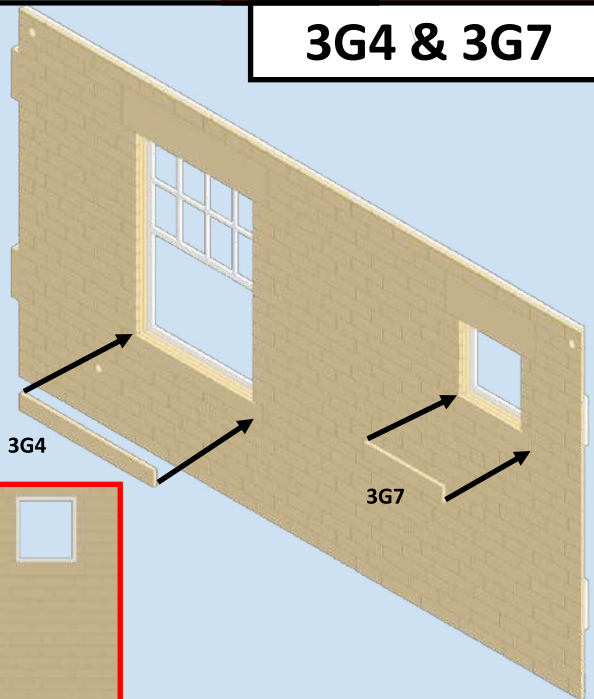

31

3A & 3B

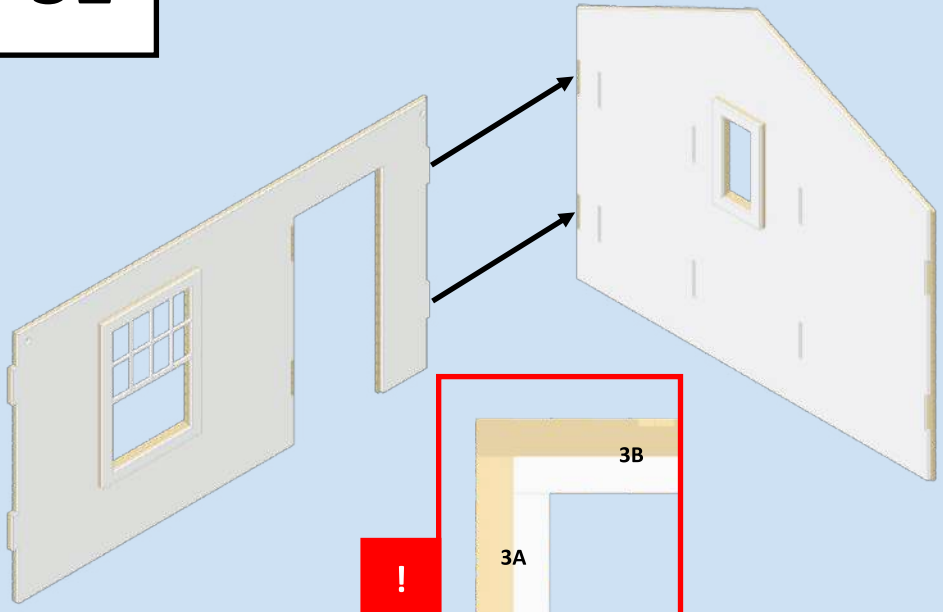

32

3E2

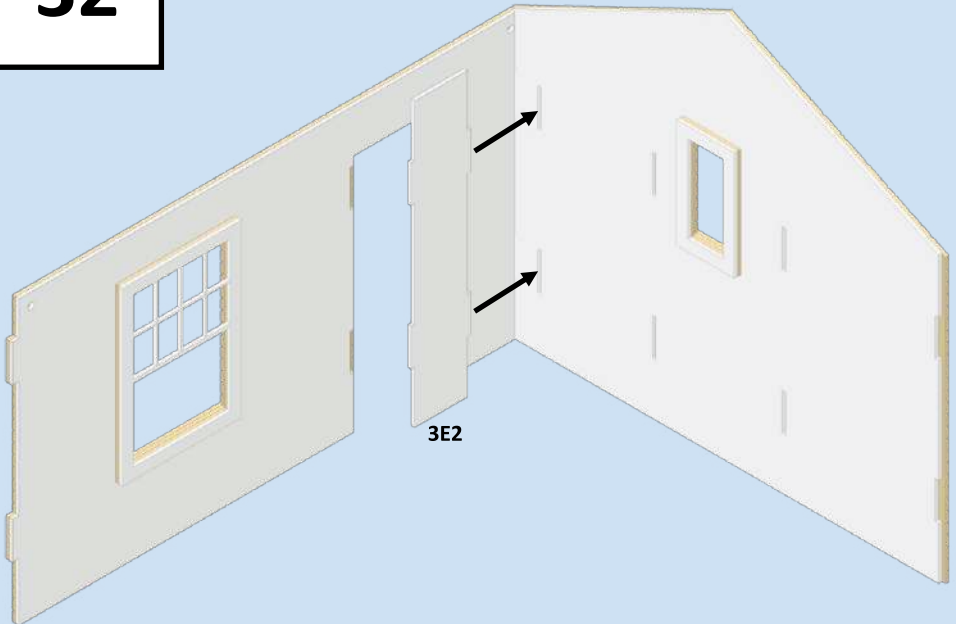

33

3E5

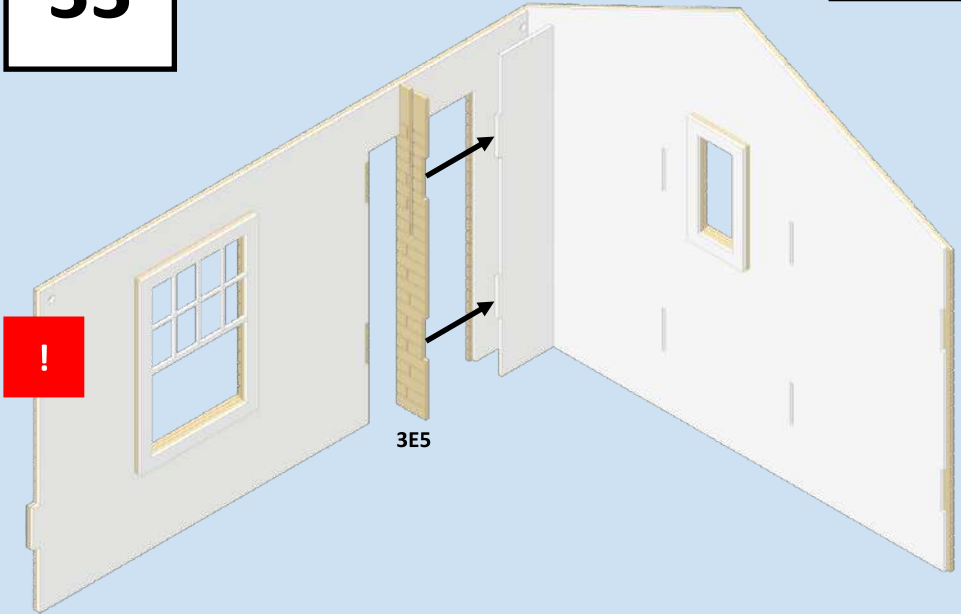

34

3E3 & 3E4

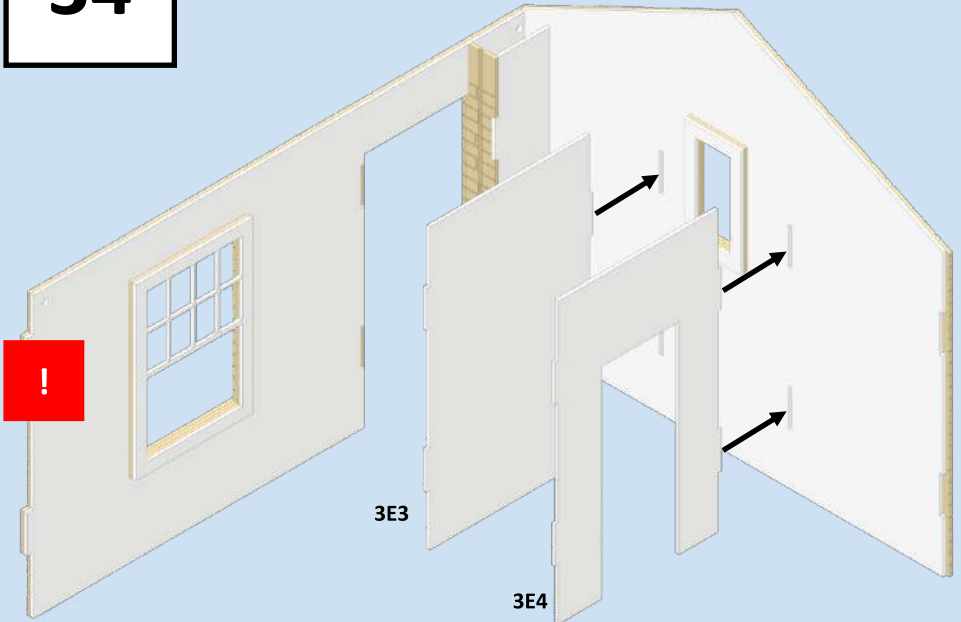

35

3E1 & 3E6

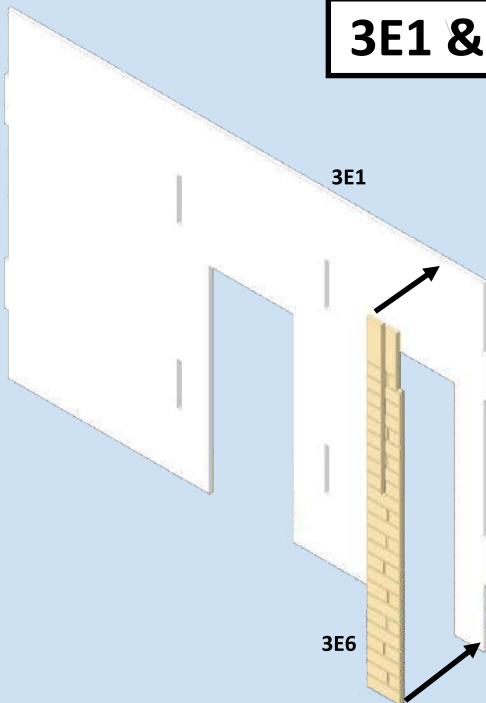

36

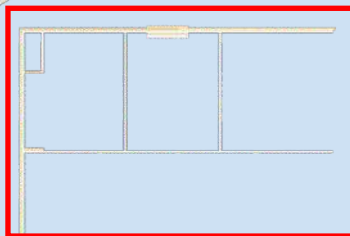
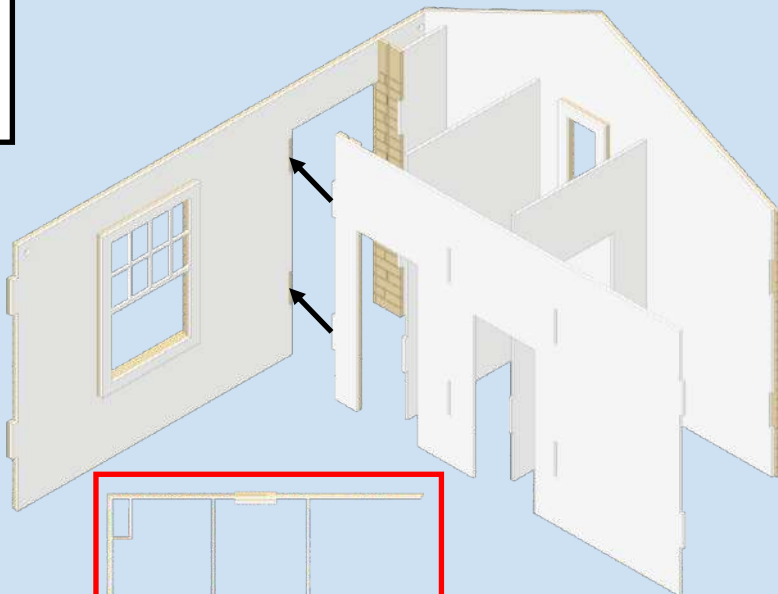

37

3AB & 3C

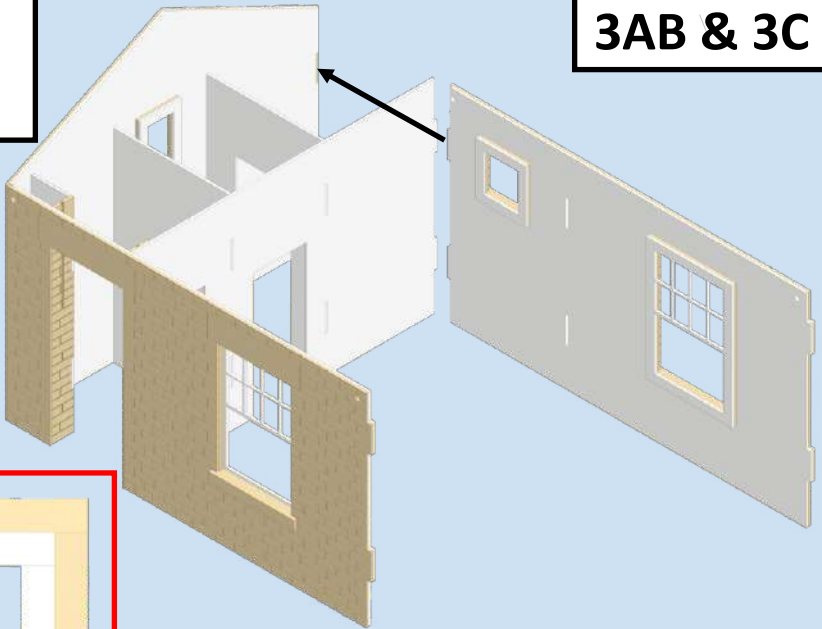

38

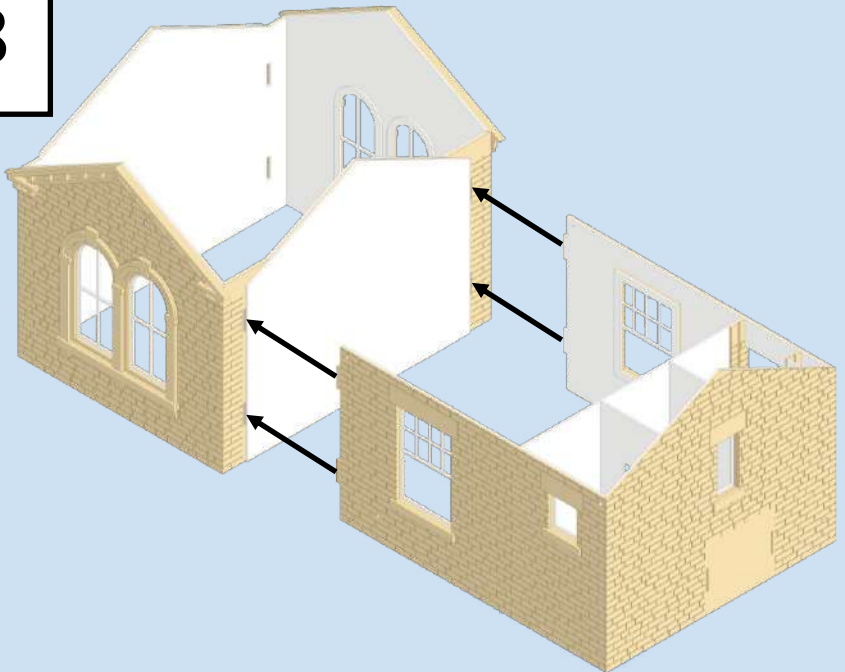

39

4A1 & 4A2

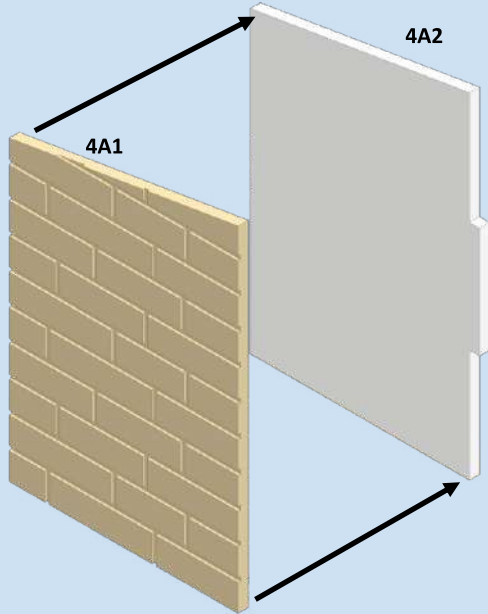

!

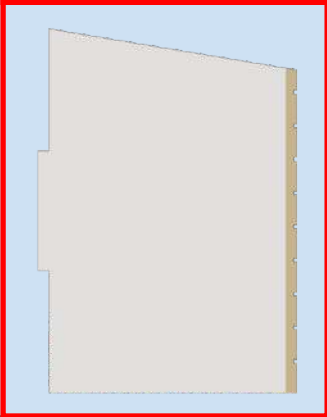

40

4A

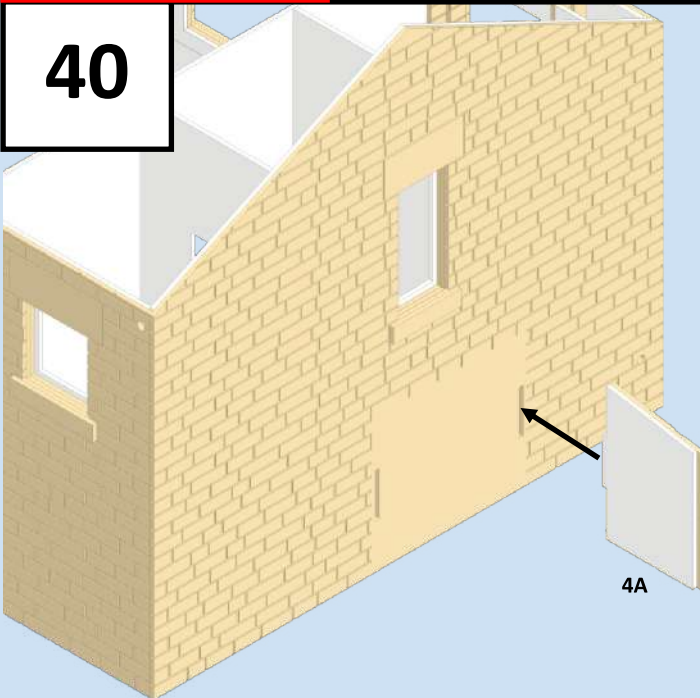

41

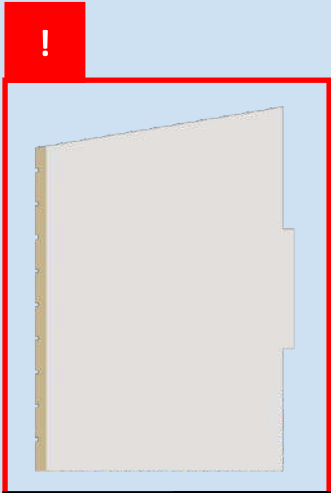

4B1 & 4B2

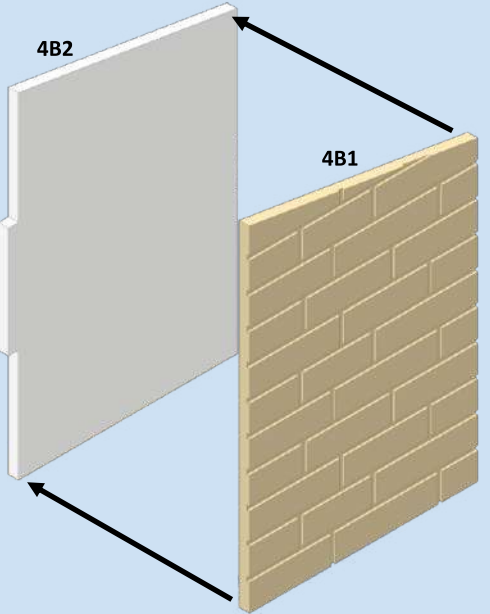

42

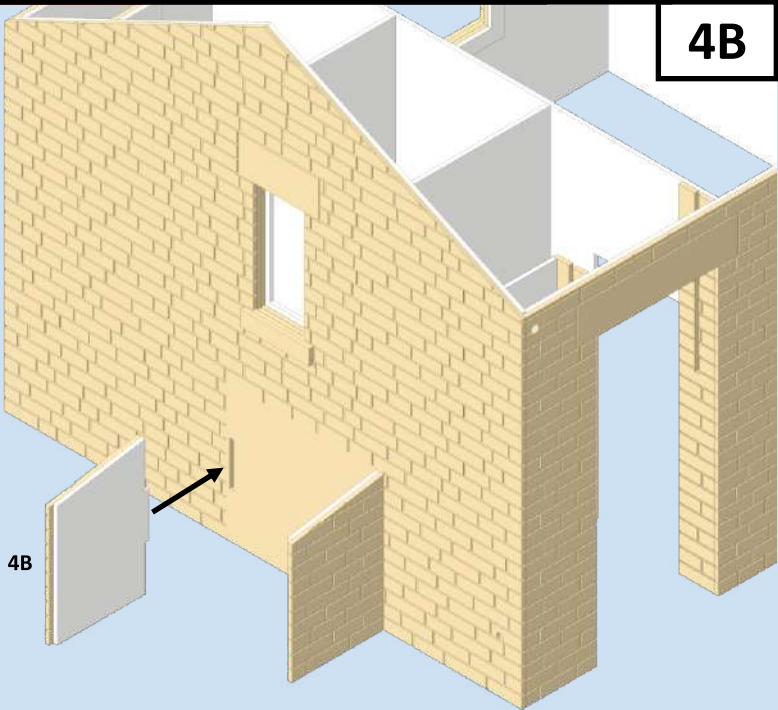

43

4C1 & 4C2

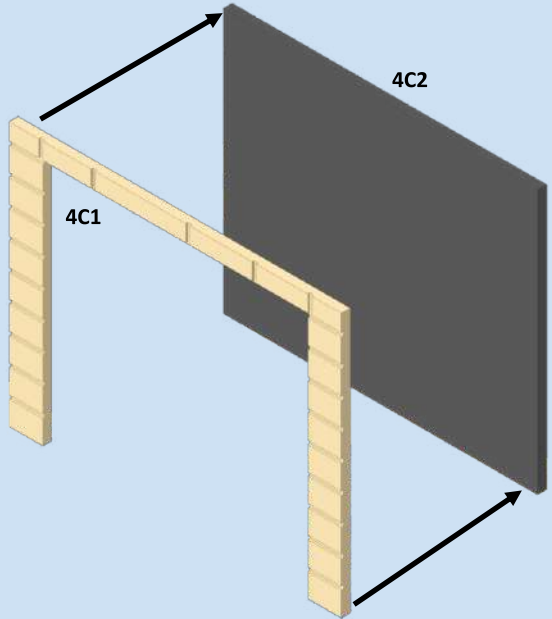

!



44

4C

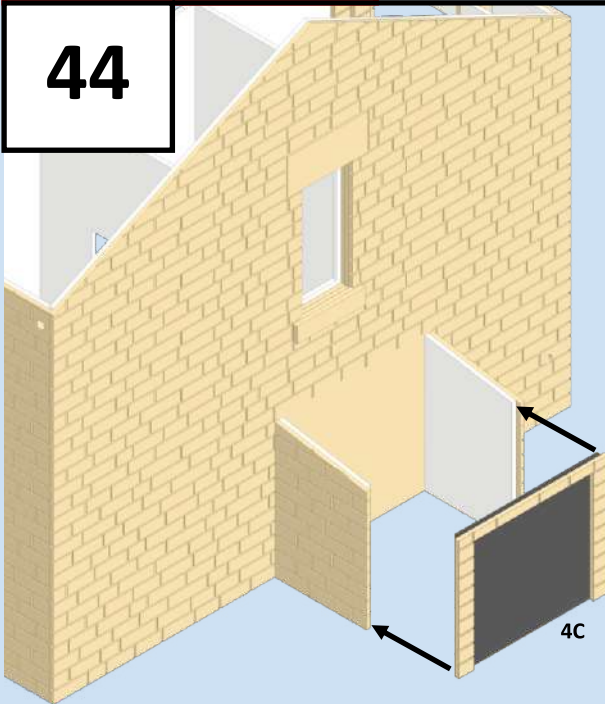

!

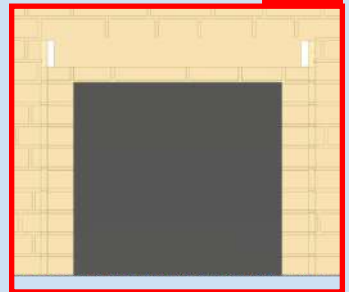

45

4D1

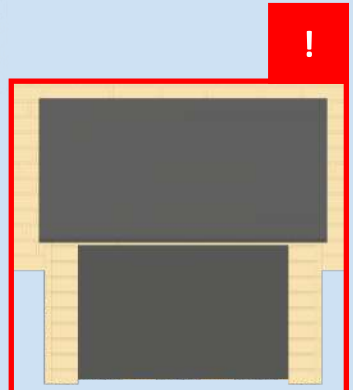
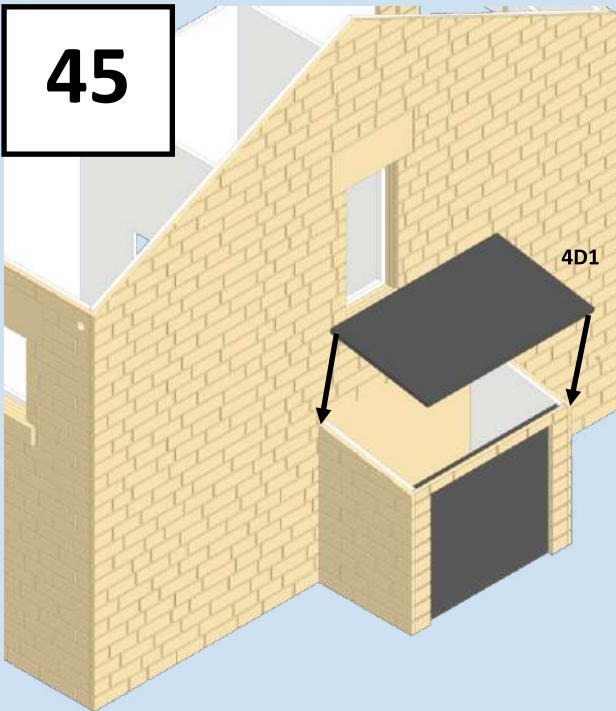

46

3G1

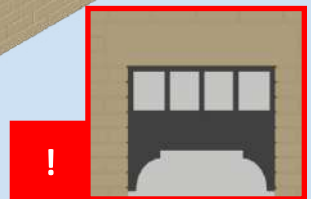
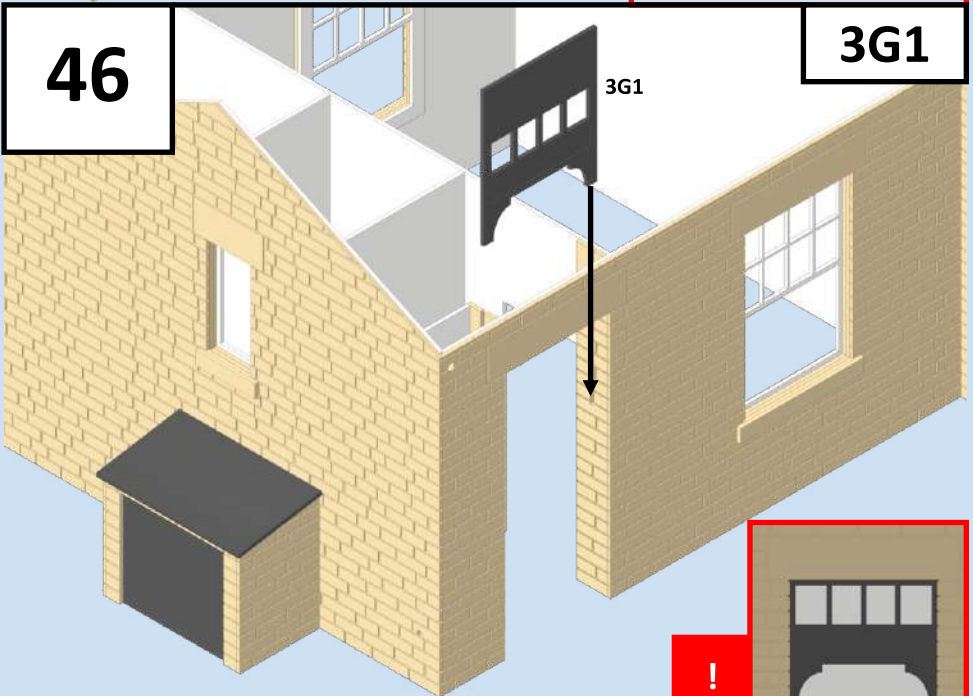

47

2A1 & 2A2

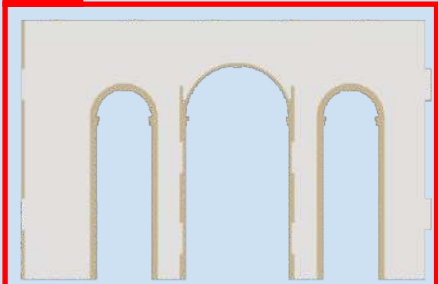
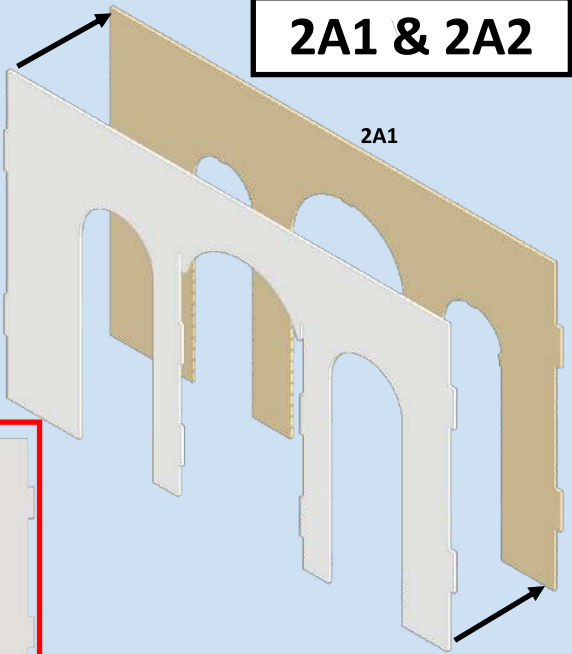

48

2E1 & 2E2

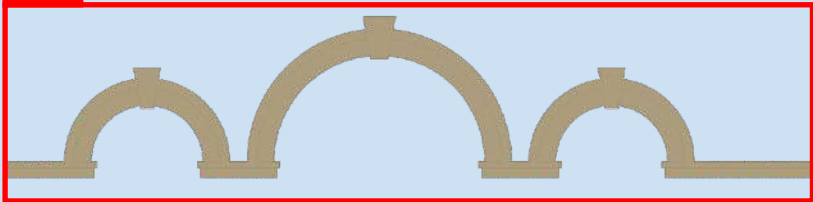

49

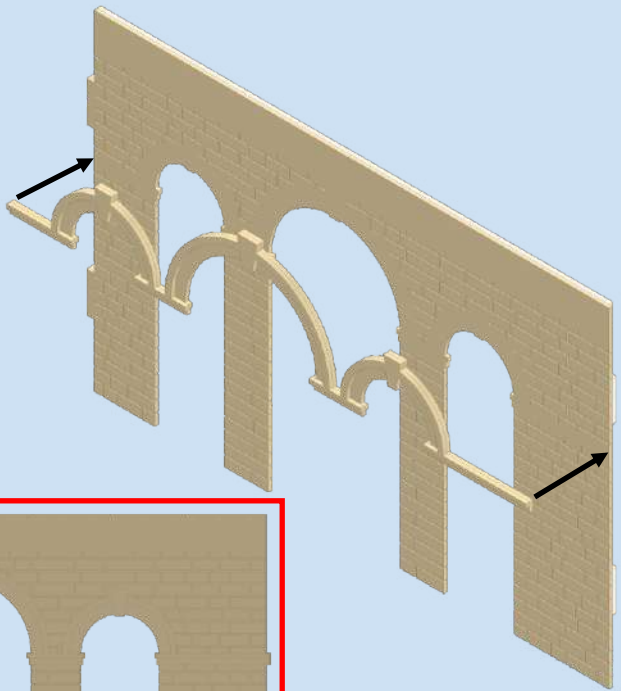

!



50

2E6, 2E7 & 2E8

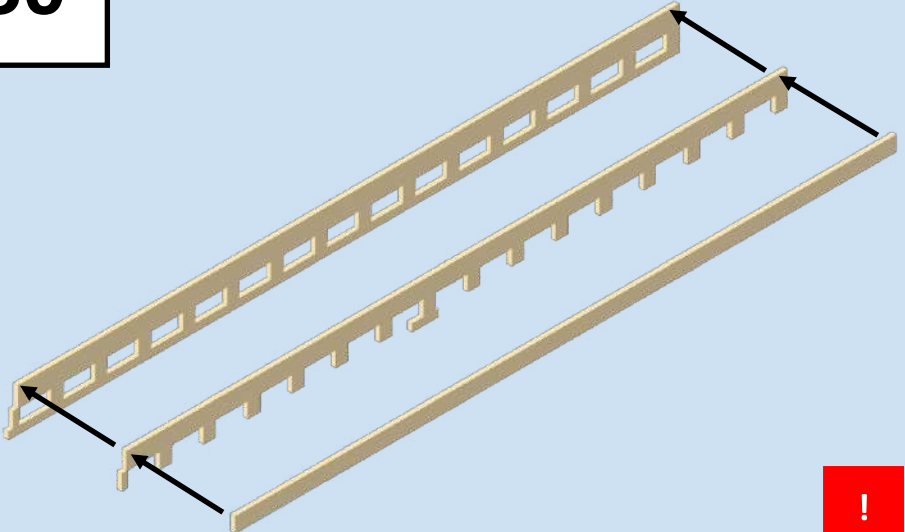

!



51

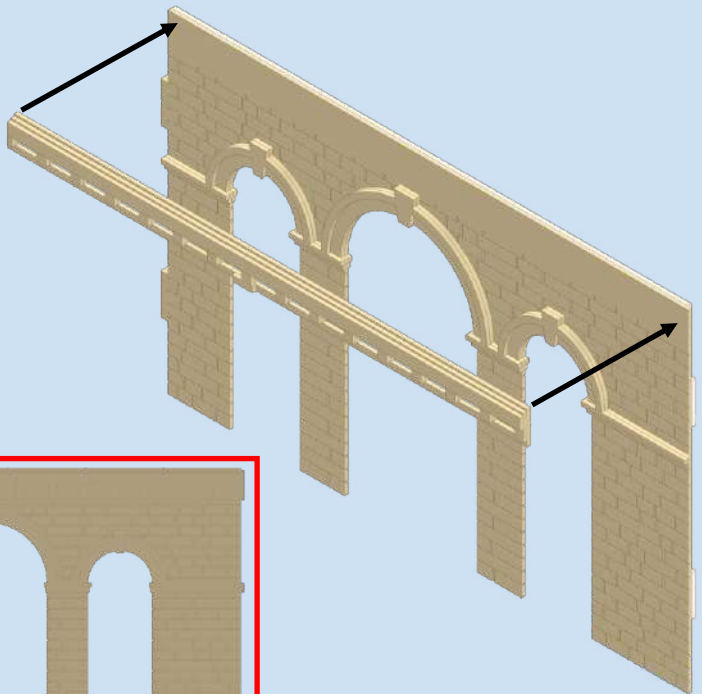

!

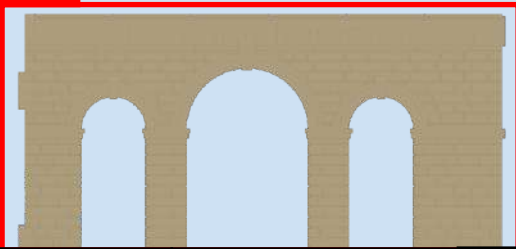

52

● , 2E3, 2E4 & 2G9

X4

!

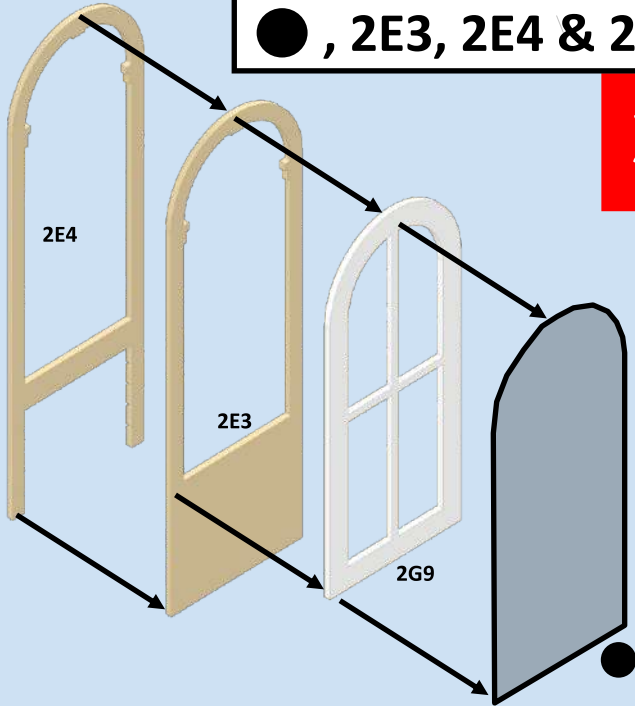
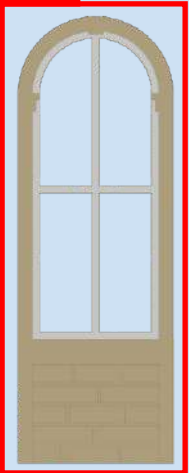

53

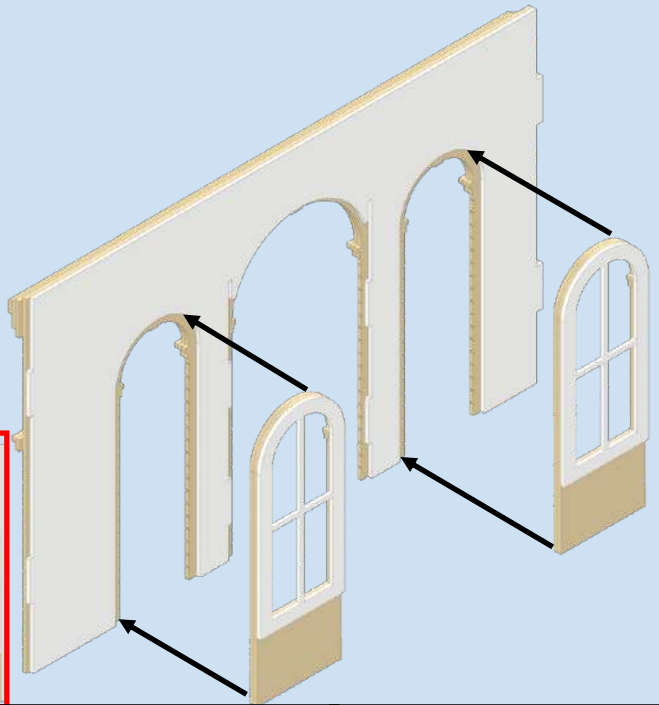
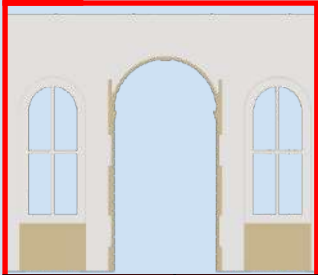

54

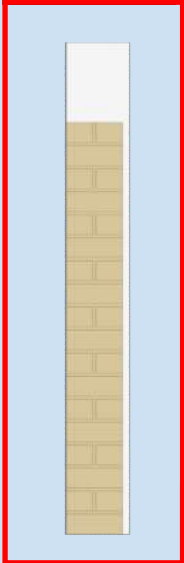

2G4 & 2G5

2G5

2G4

X2

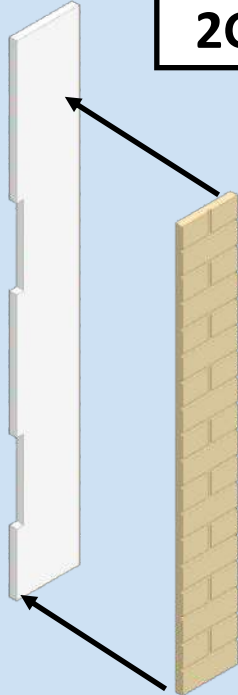

55

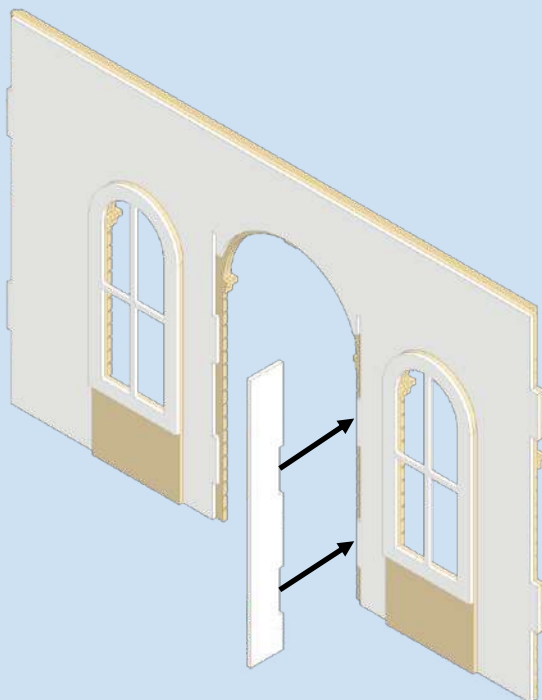

56

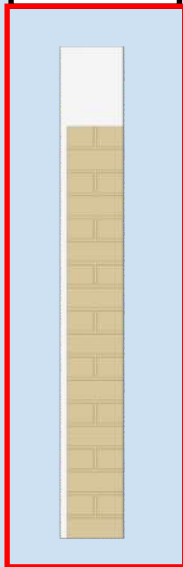

2G4 & 2G5

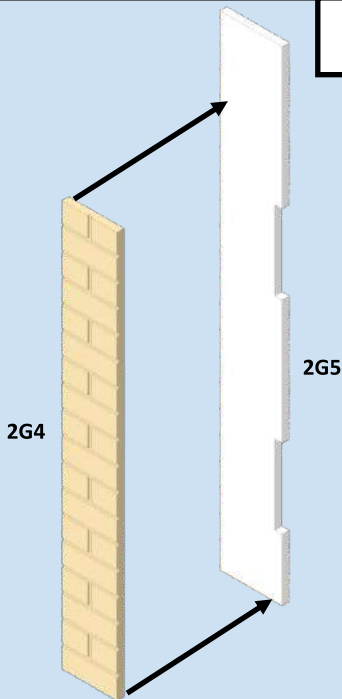

X2

57

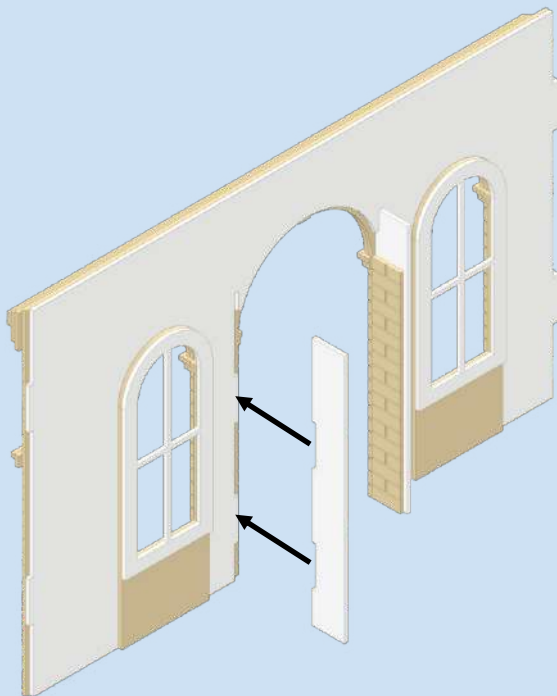

58

2G8

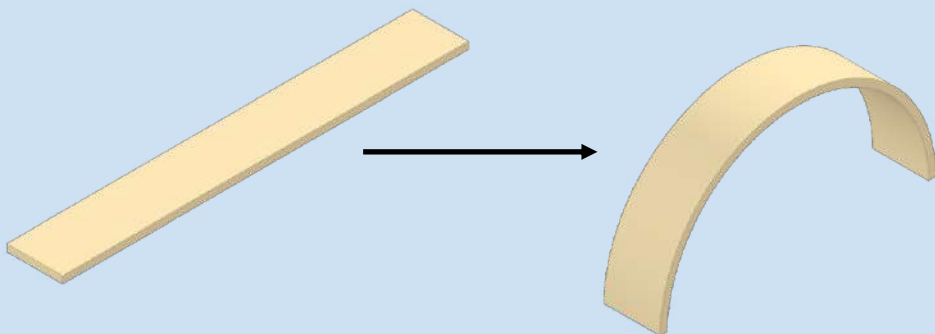

X2

59

2G8

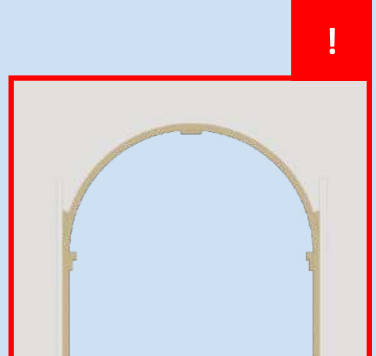
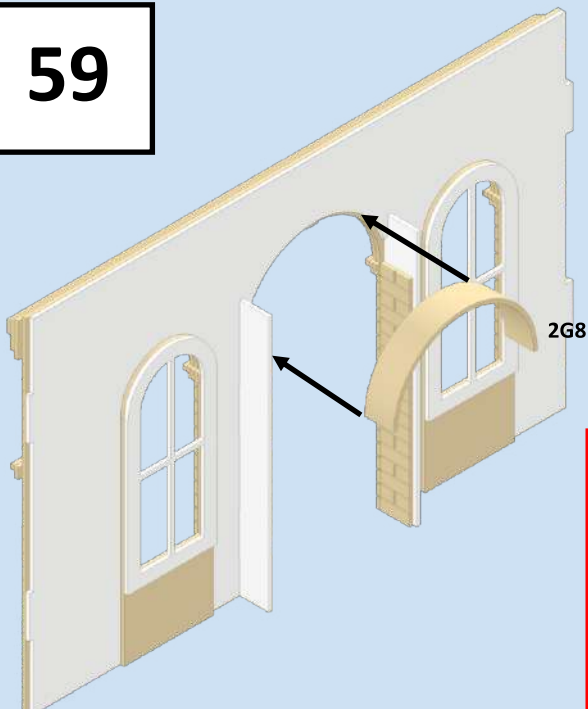

60

2G1

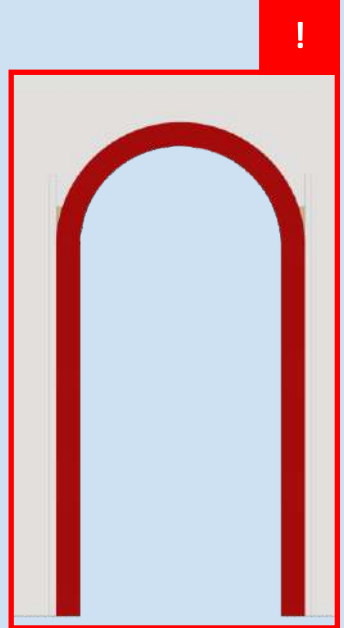
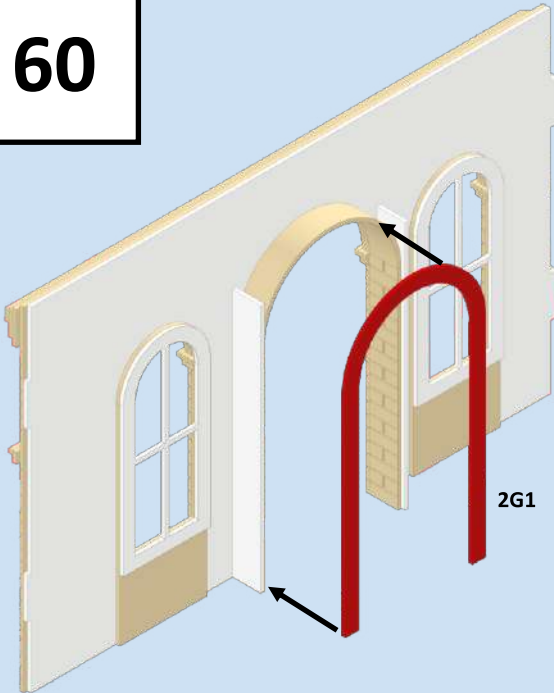

61

2G2 & 2G3

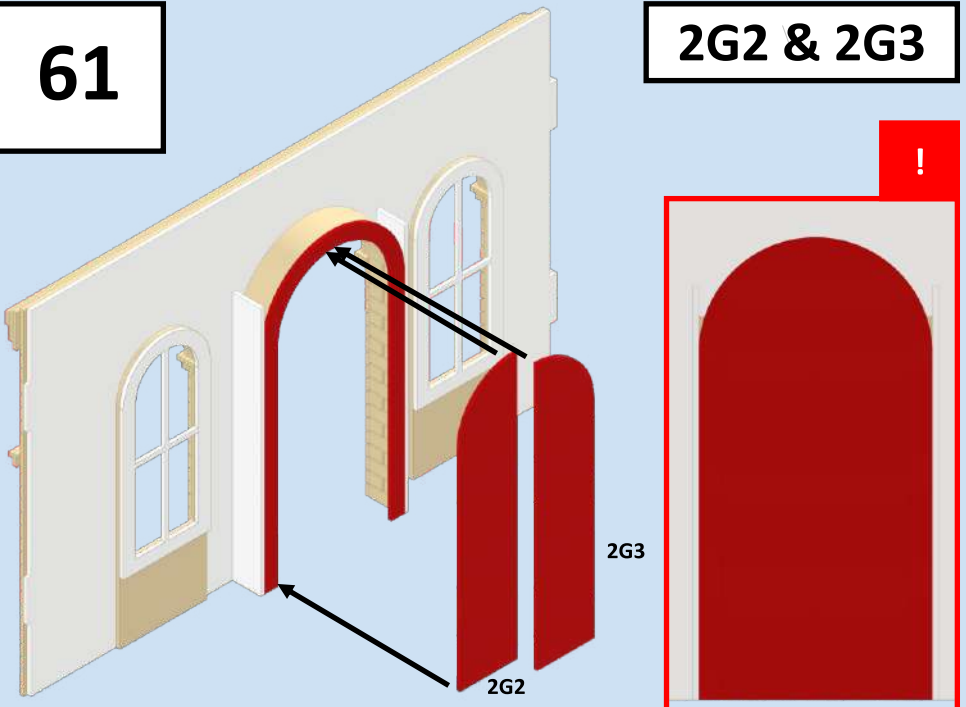

62

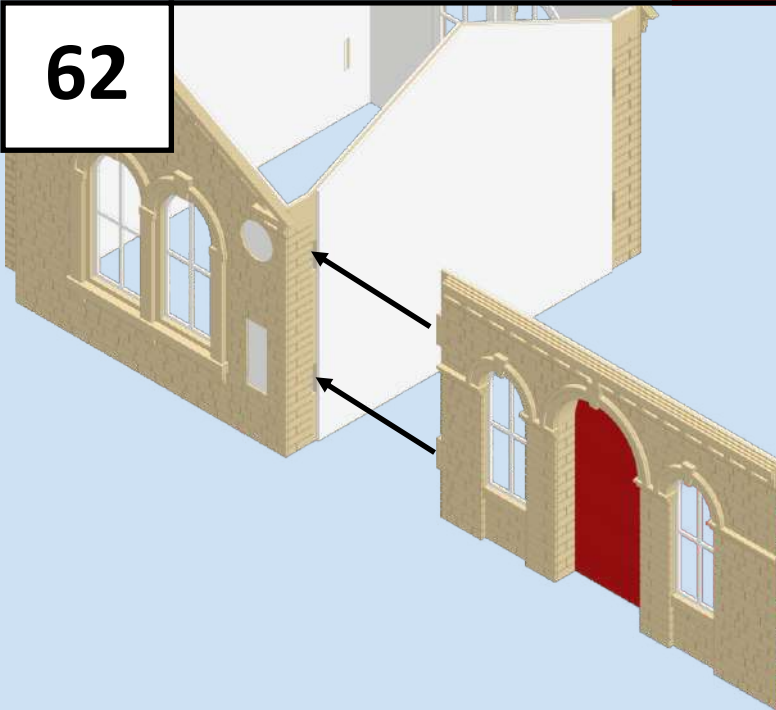

63

2C1 & 2C2

2C2

2C1

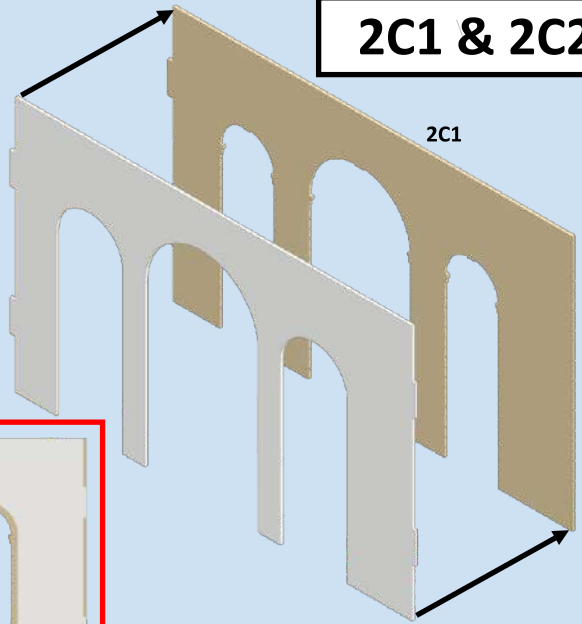
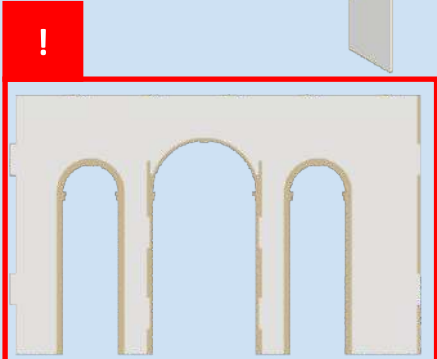

64

2E1 & 2E2

2E1

2E2

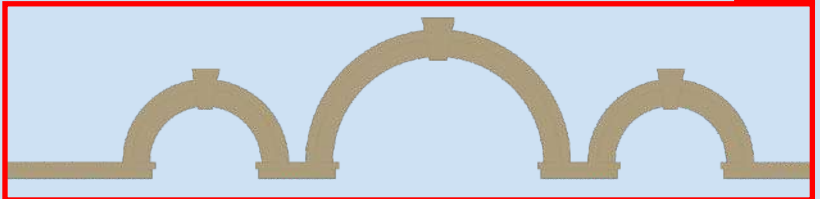
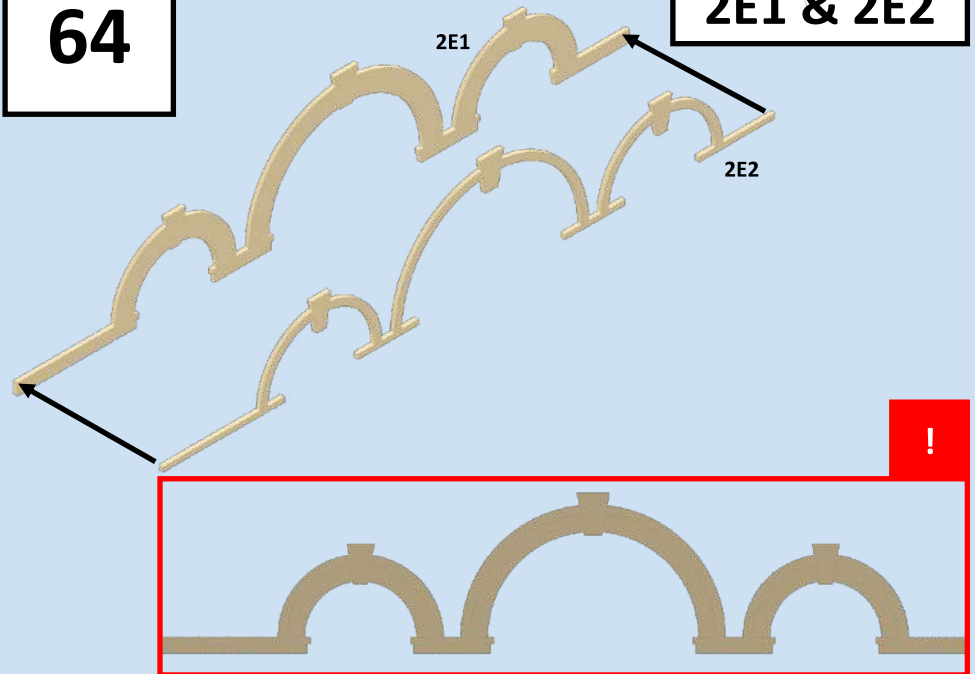

65

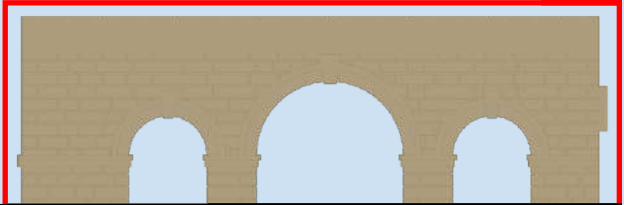
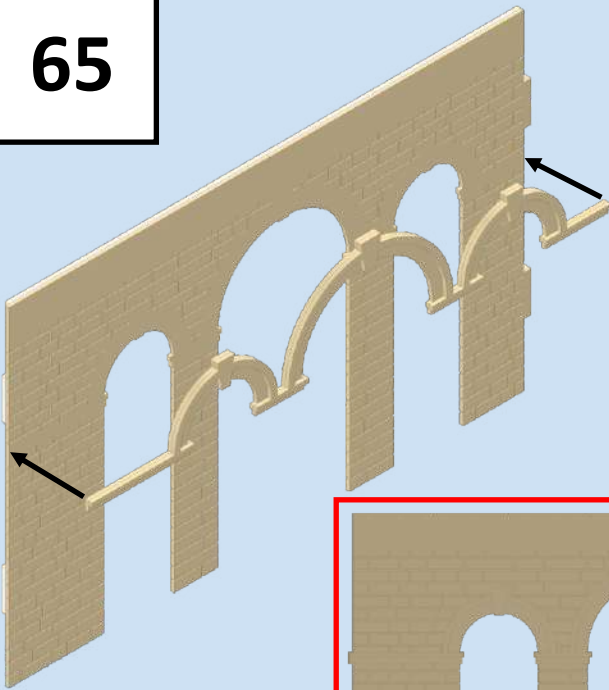

66

2E6, 2E7 & 2E8

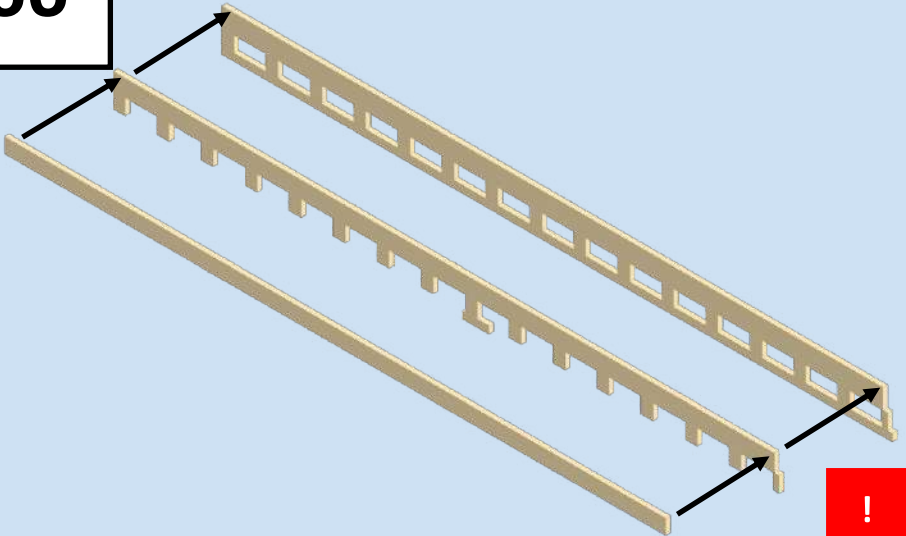

67

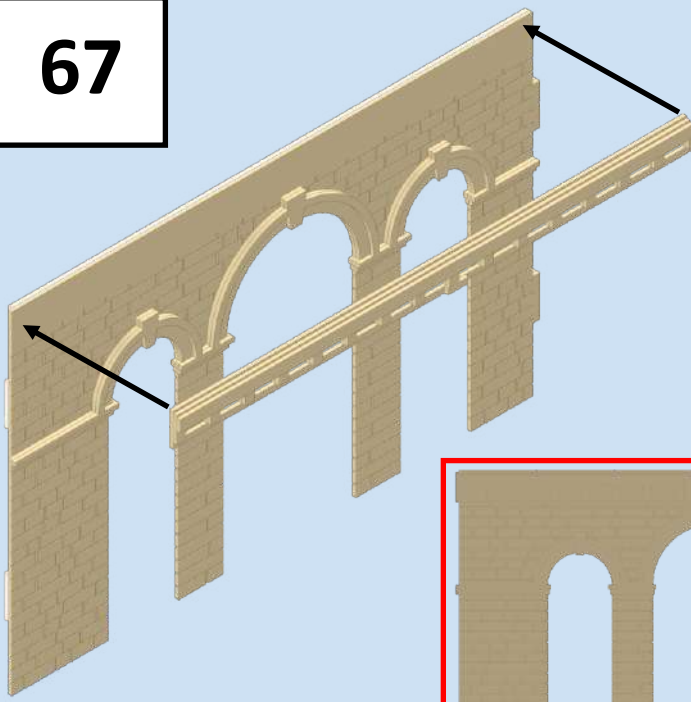

68

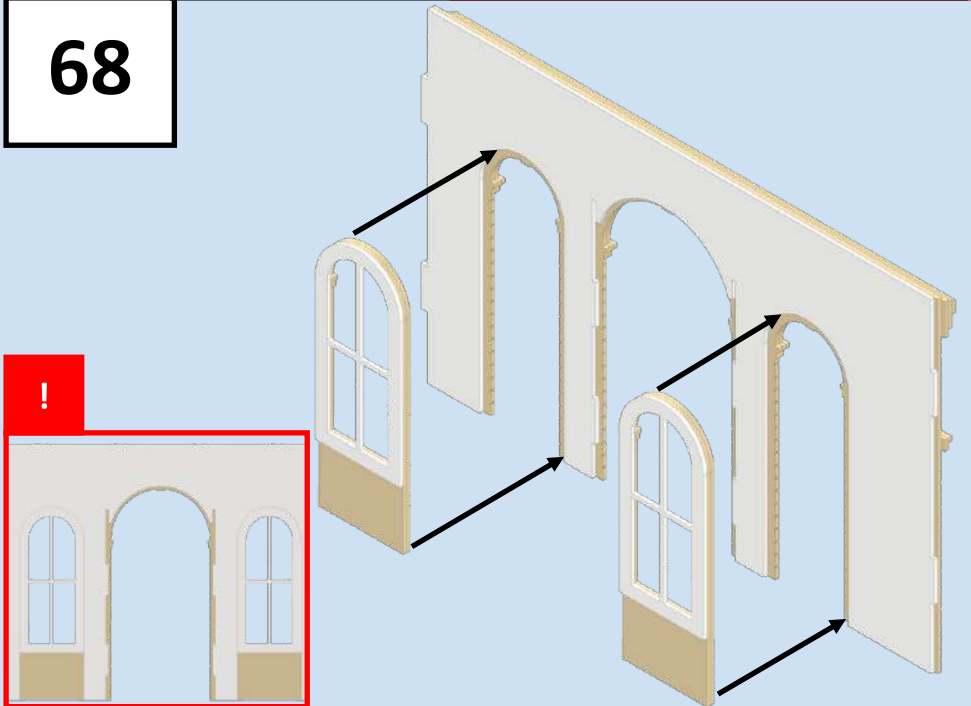

69

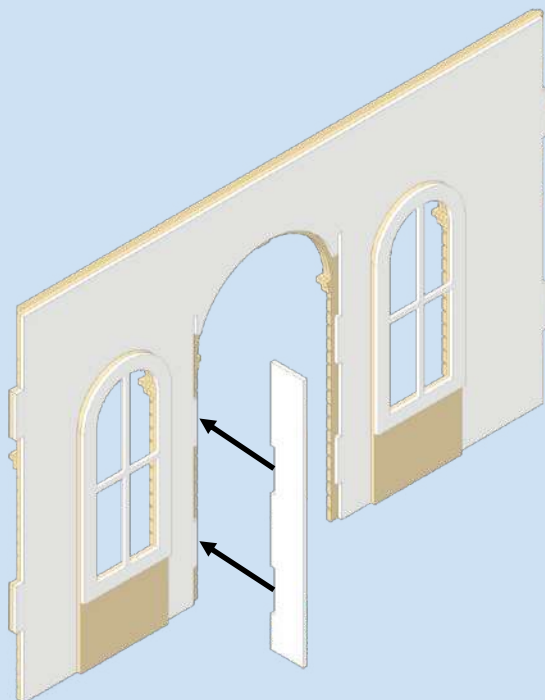

70

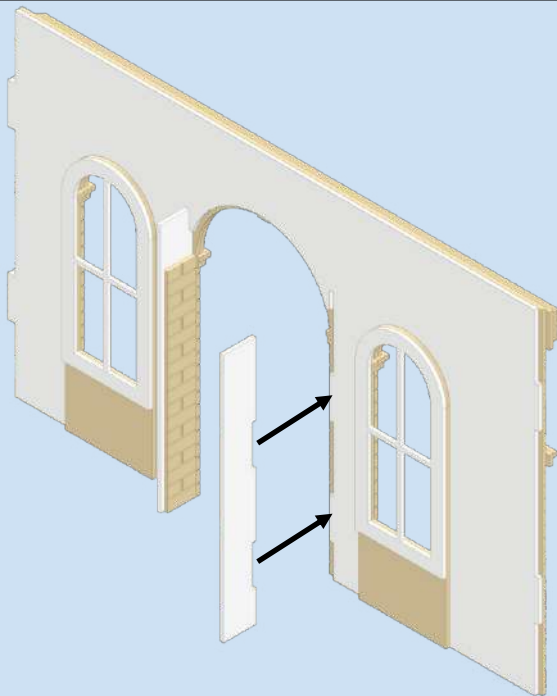

71

2G8

2G8

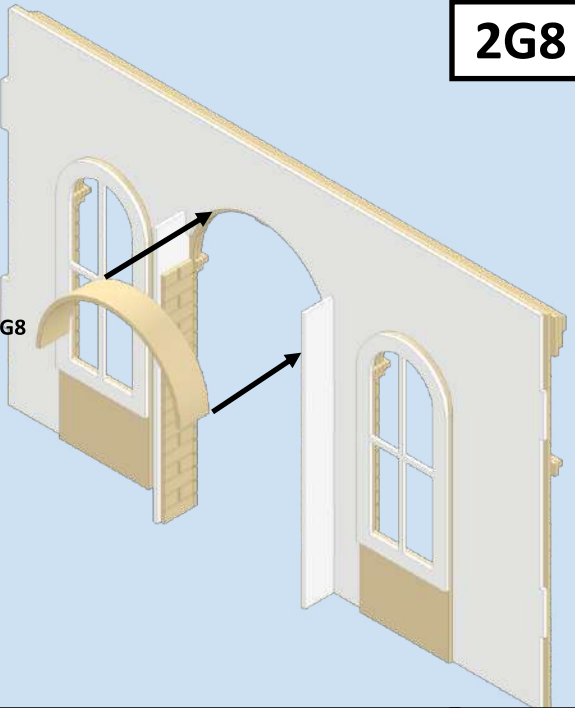

!

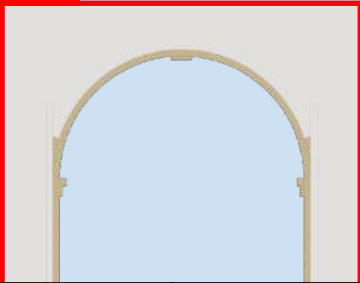

72

2G1

2G1

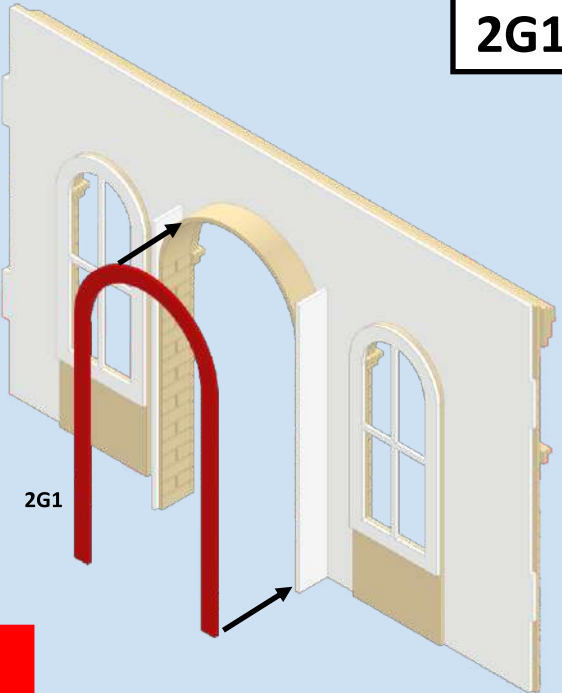

!

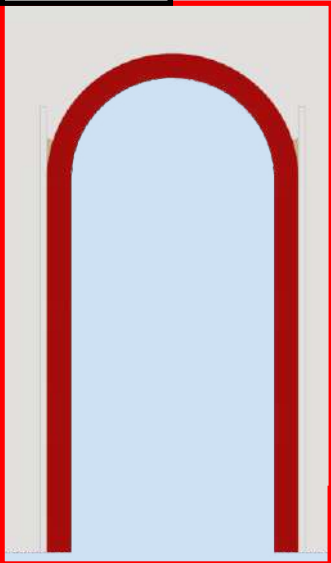

73

2G2 & 2G3

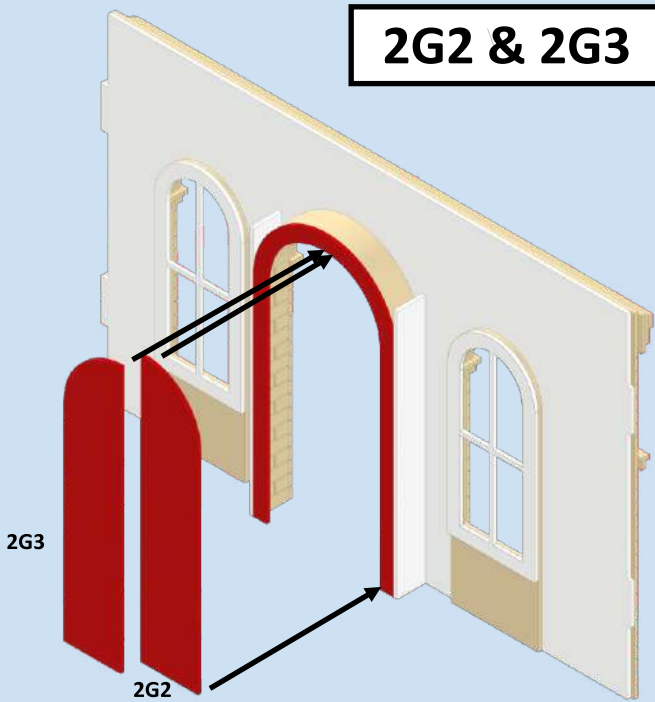
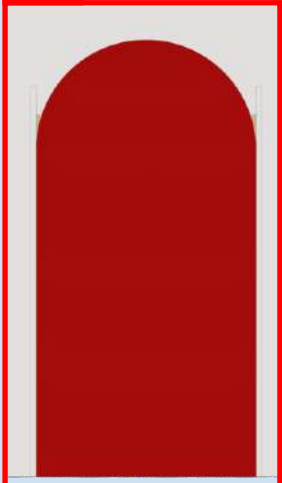

74

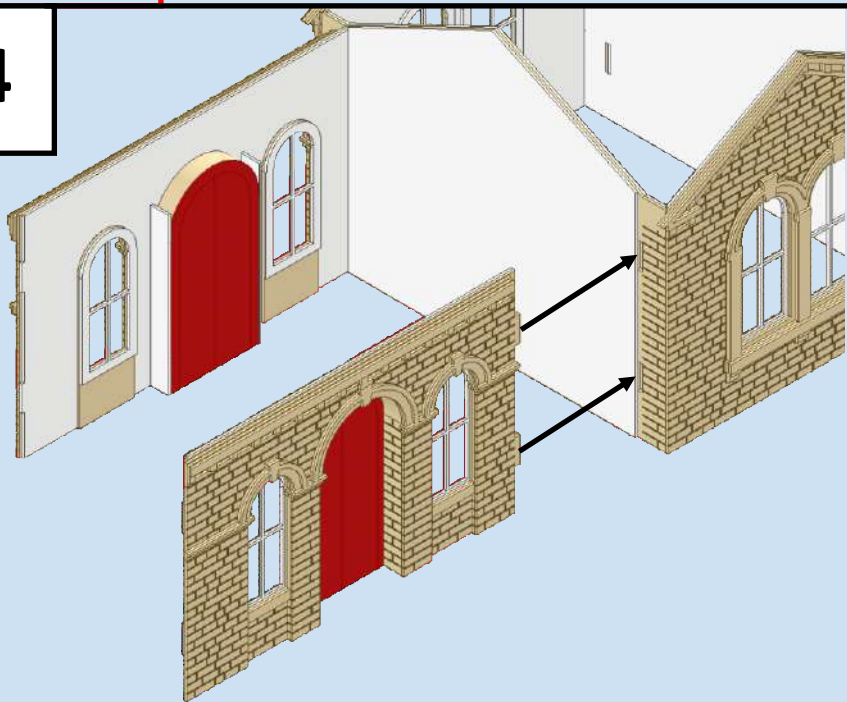

75

2B1 & 2B2

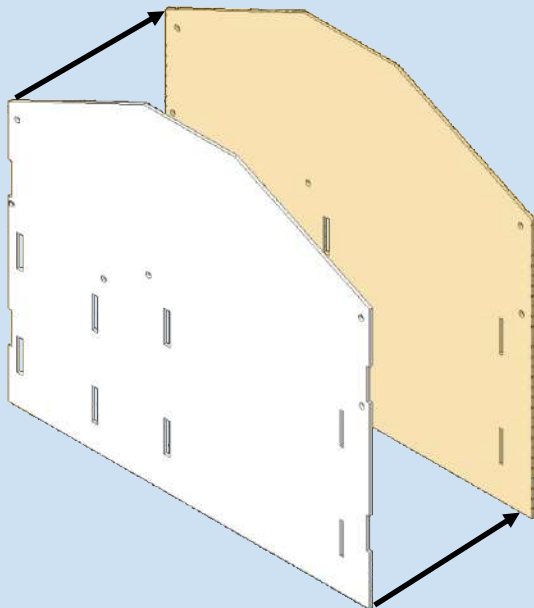

!

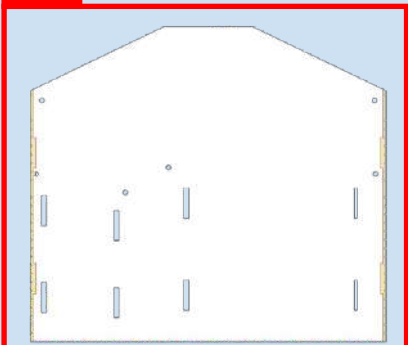

76

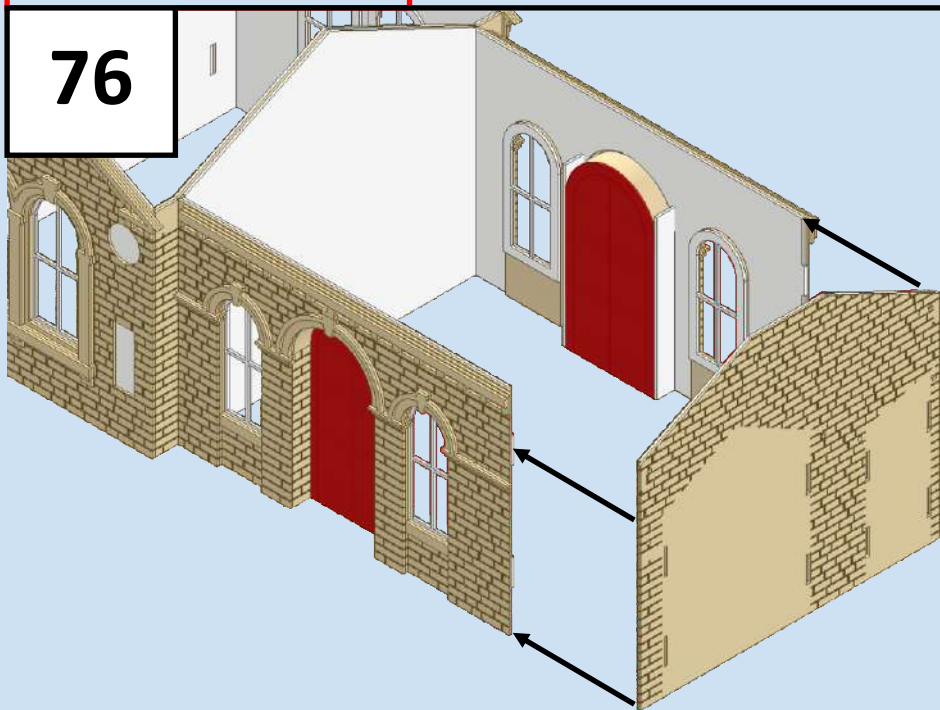

77

5C1 & 5C2

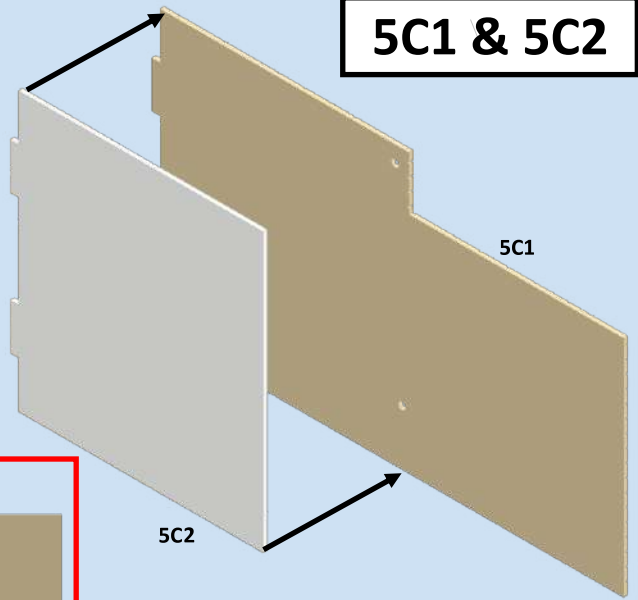

!



78

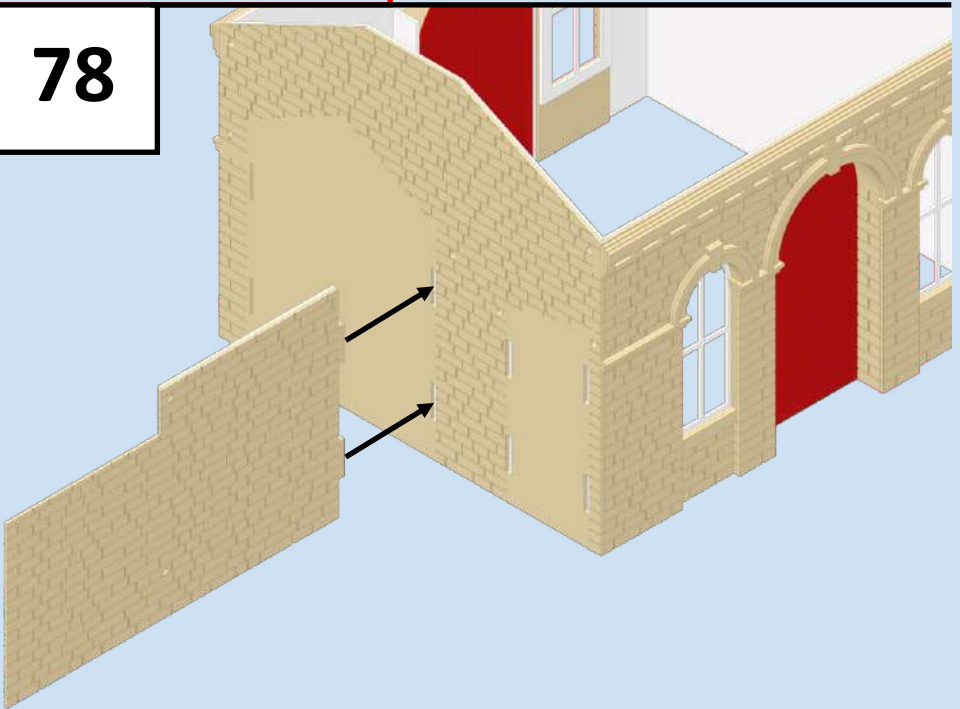

79

5B1 & 5B2

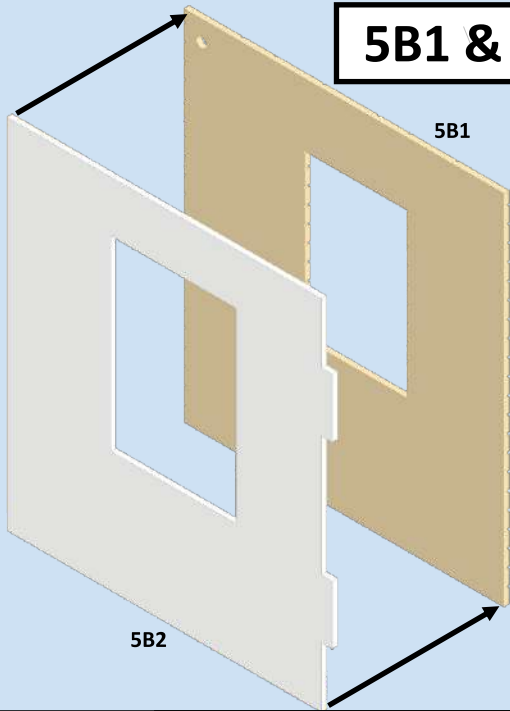
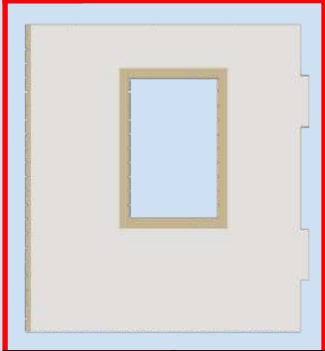

80

▲ , 5G1 & 5G2(x2)

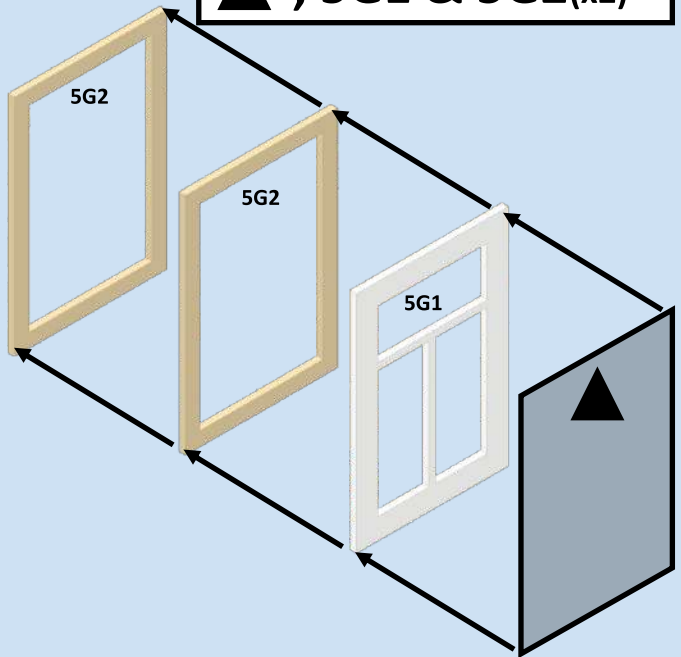
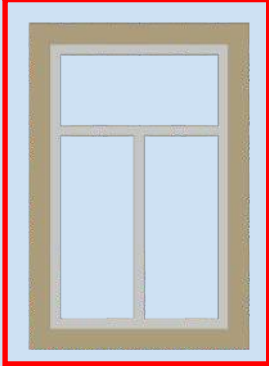

81

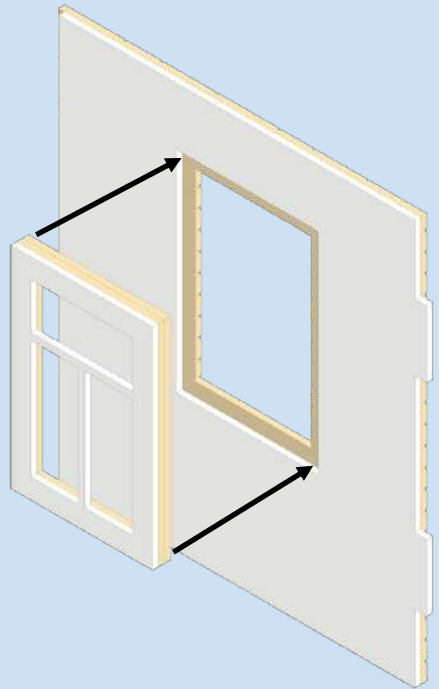
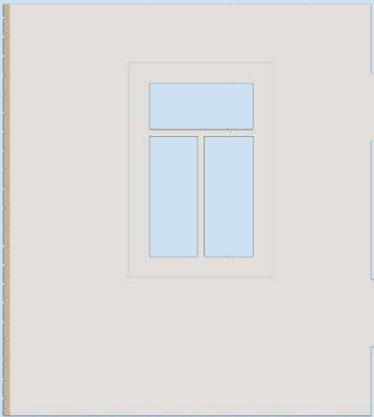

82

5G3

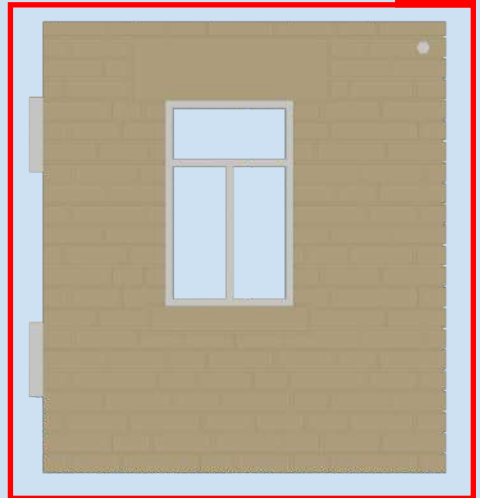
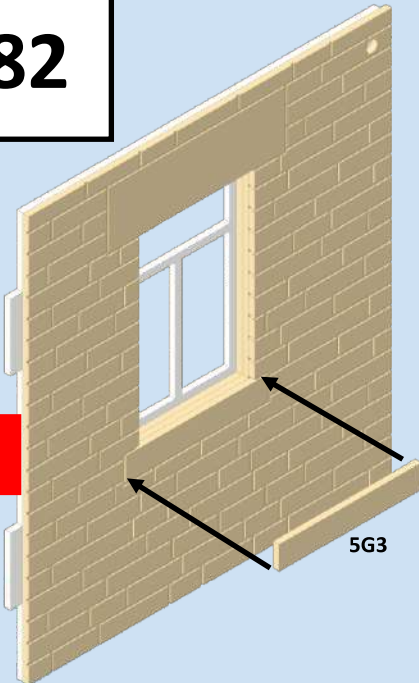

83

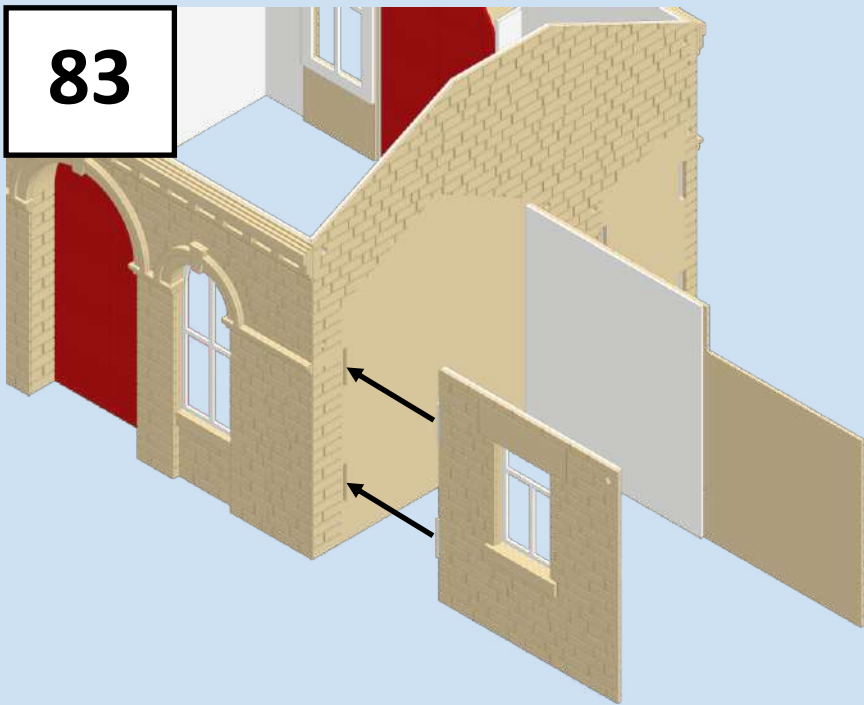

84

5A1 & 5A2

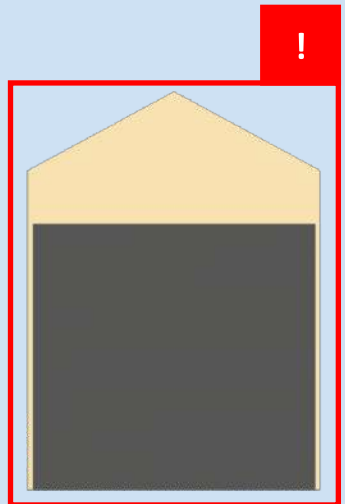
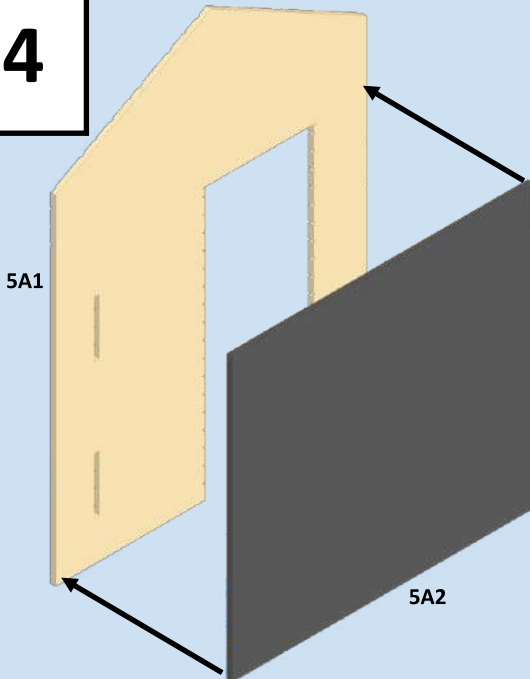

85

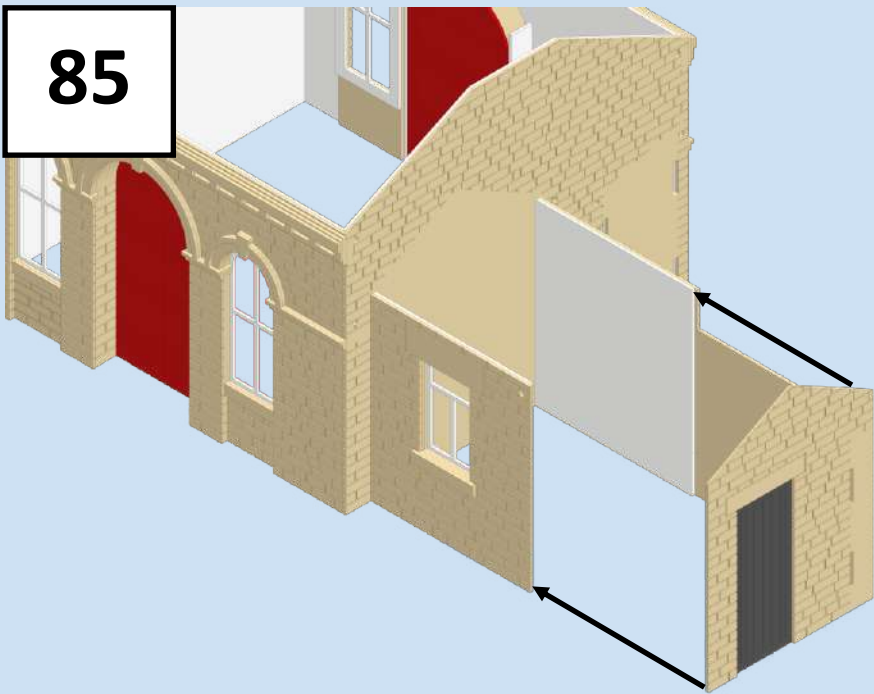

86

5D1

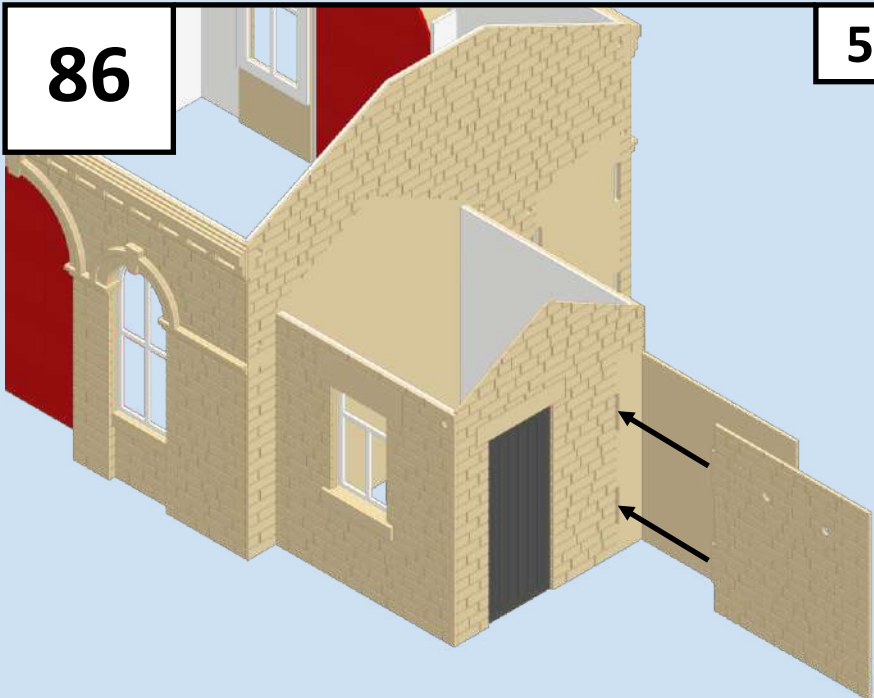

5D1

87

5E1 & 5E2



5E1



5E2



88



89

5H1(x2)

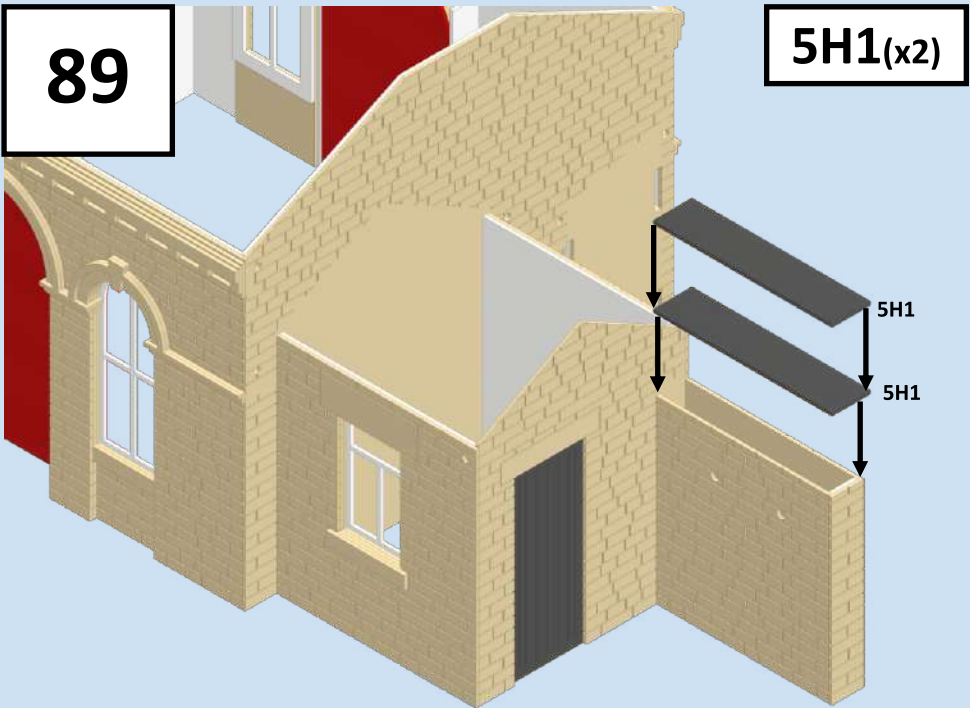

90

J8

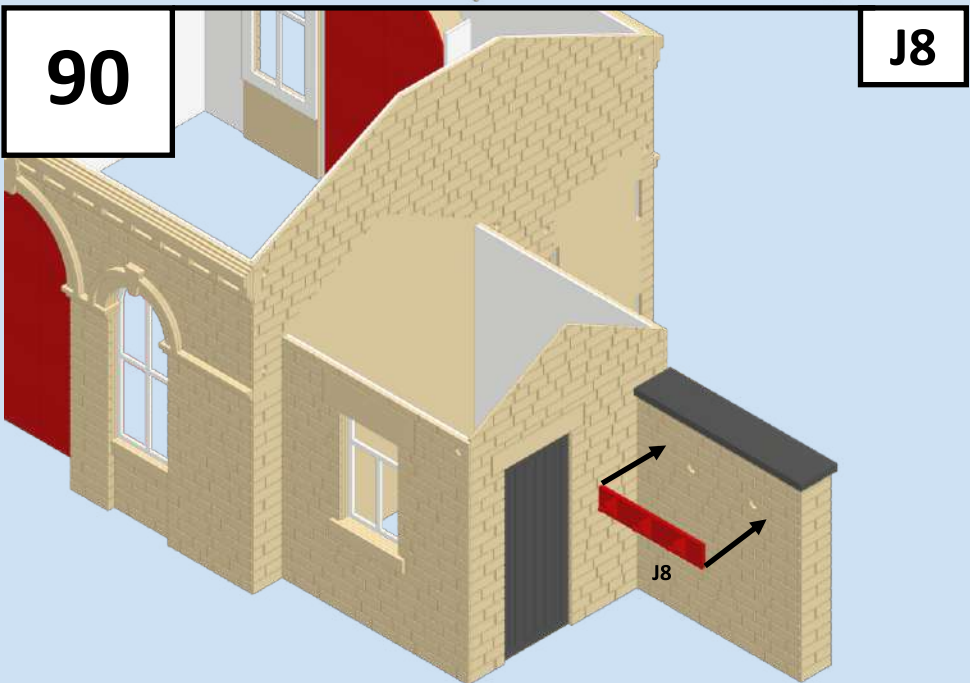

91

6C1 & 6C2

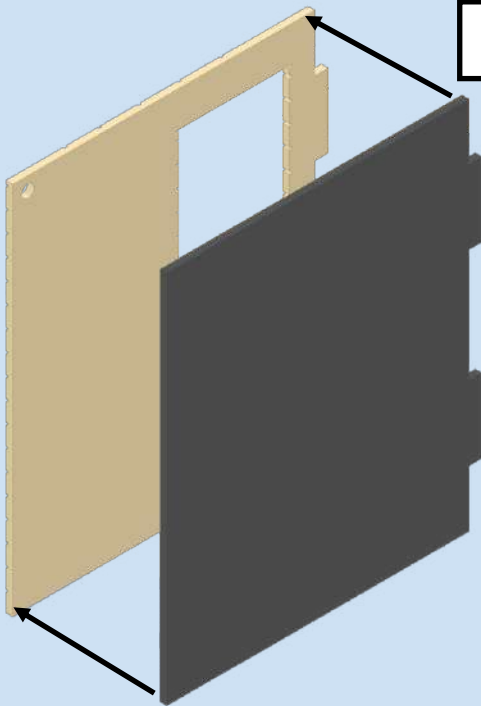

92

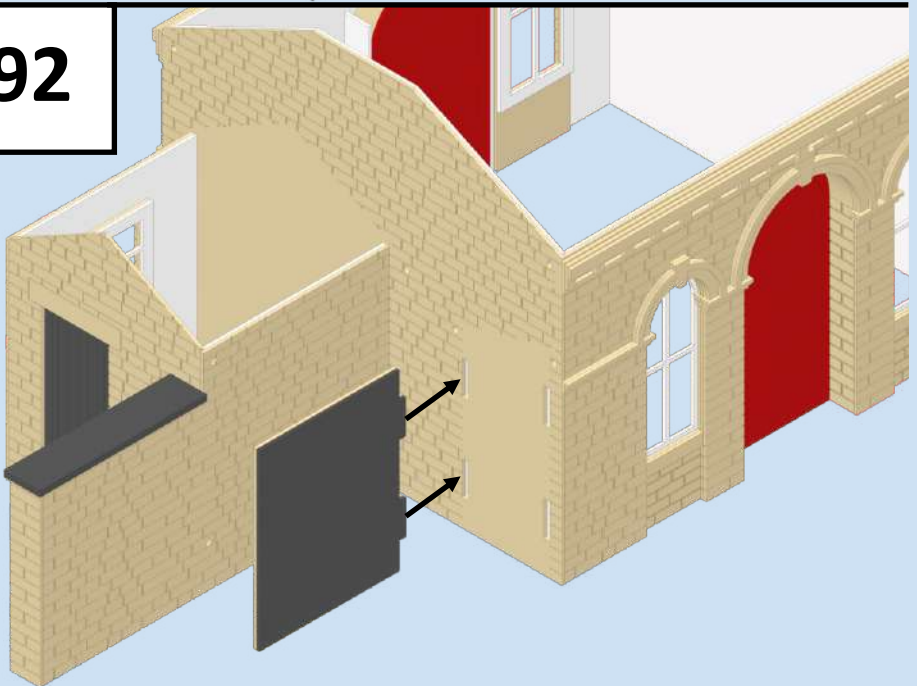

93

6A1 & 6A2

6A1

6A2

!

94

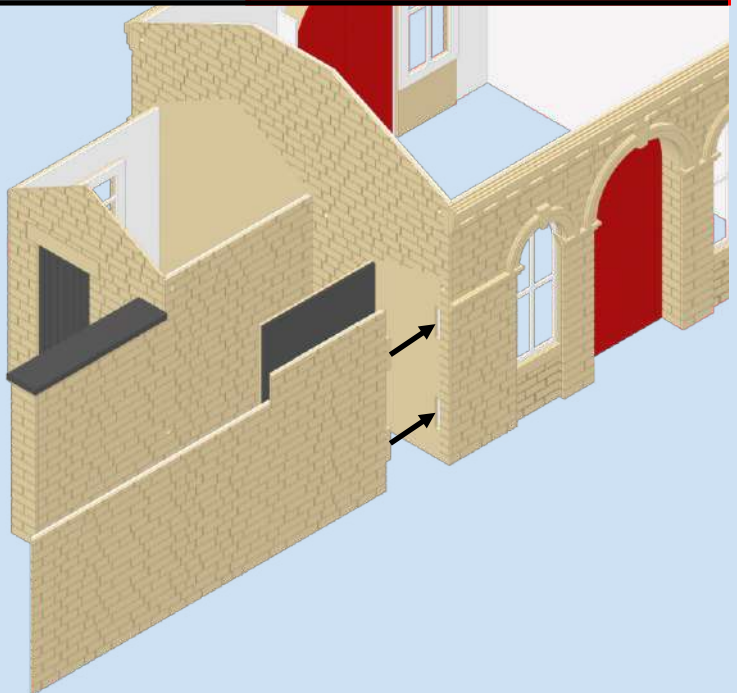

95

6B1

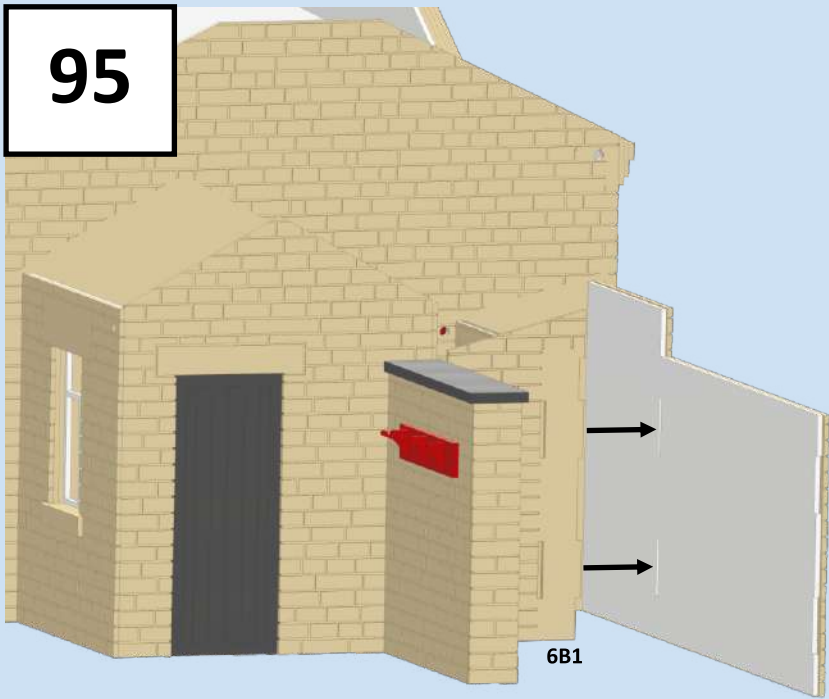

96

6G2

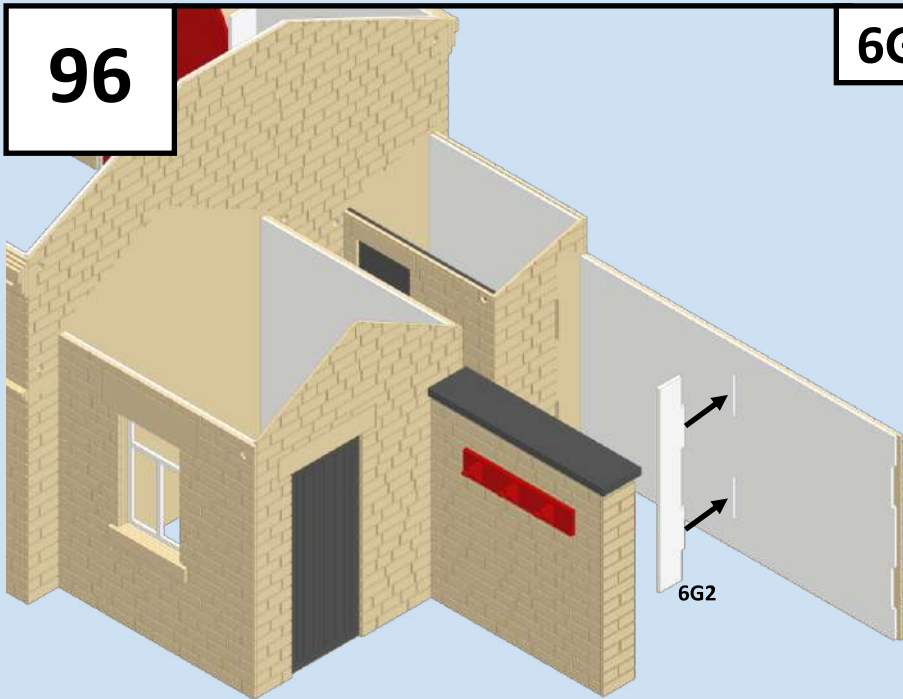

97

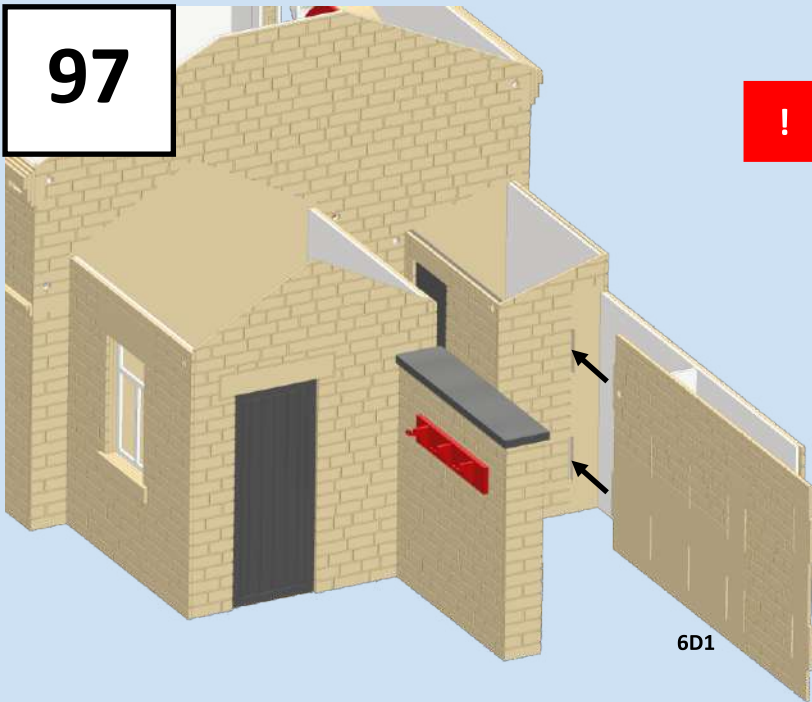

6D1

6D1

!

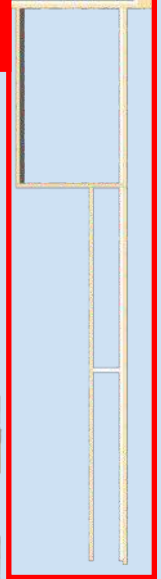

98

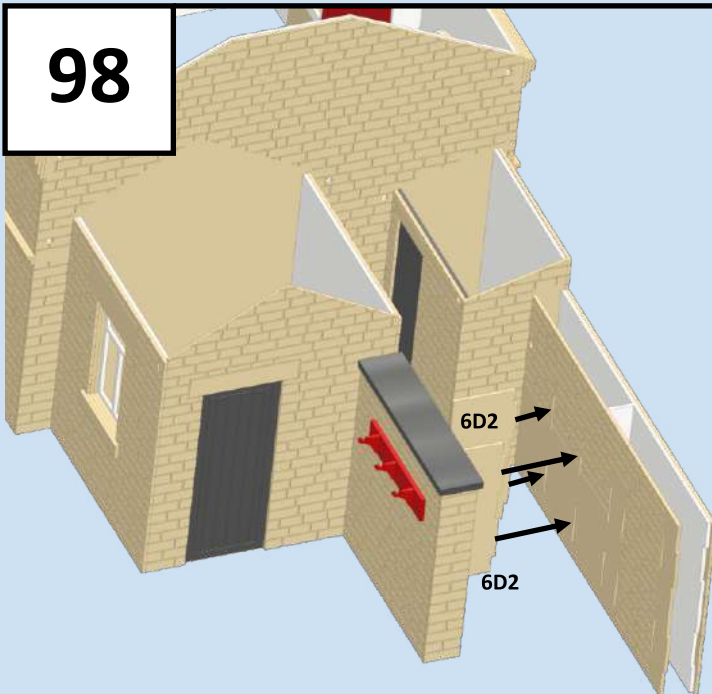

6D2

6D2

6D2(x2)

!

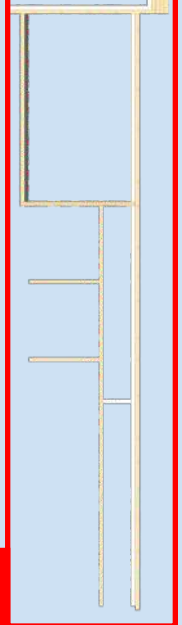

99

6D3(x3)

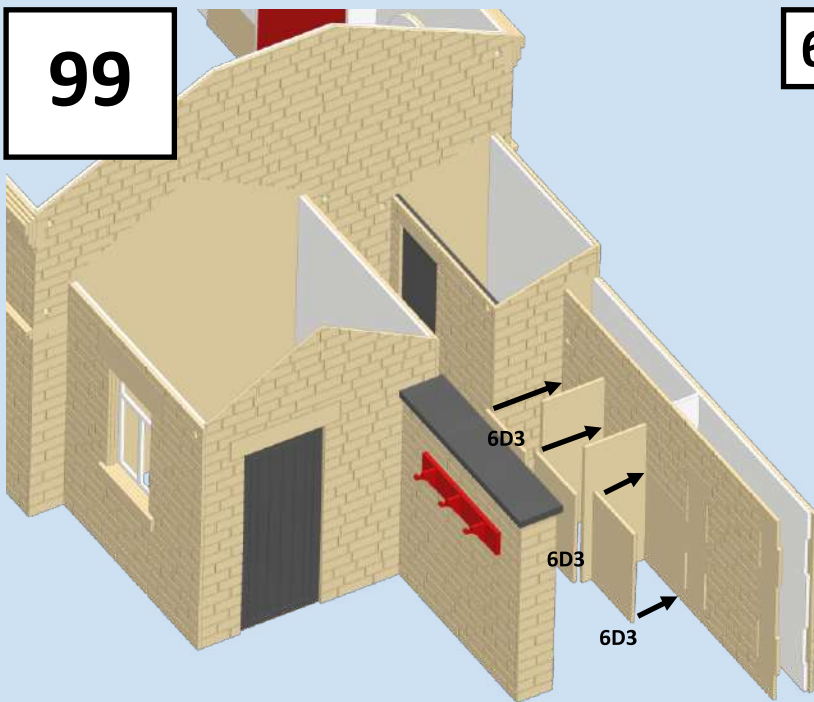

100

6H1

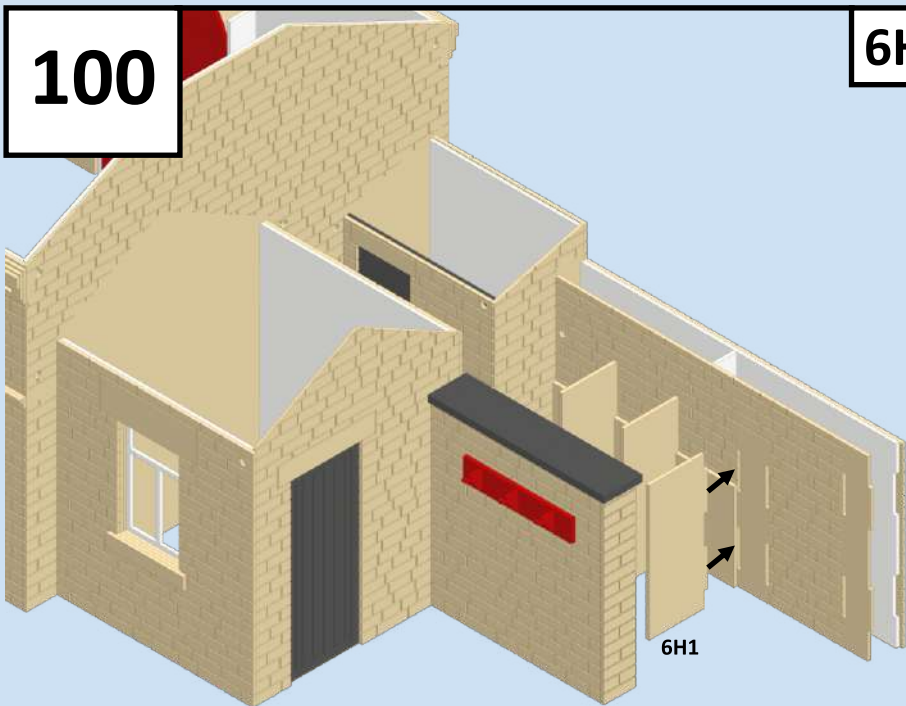

101

6H2

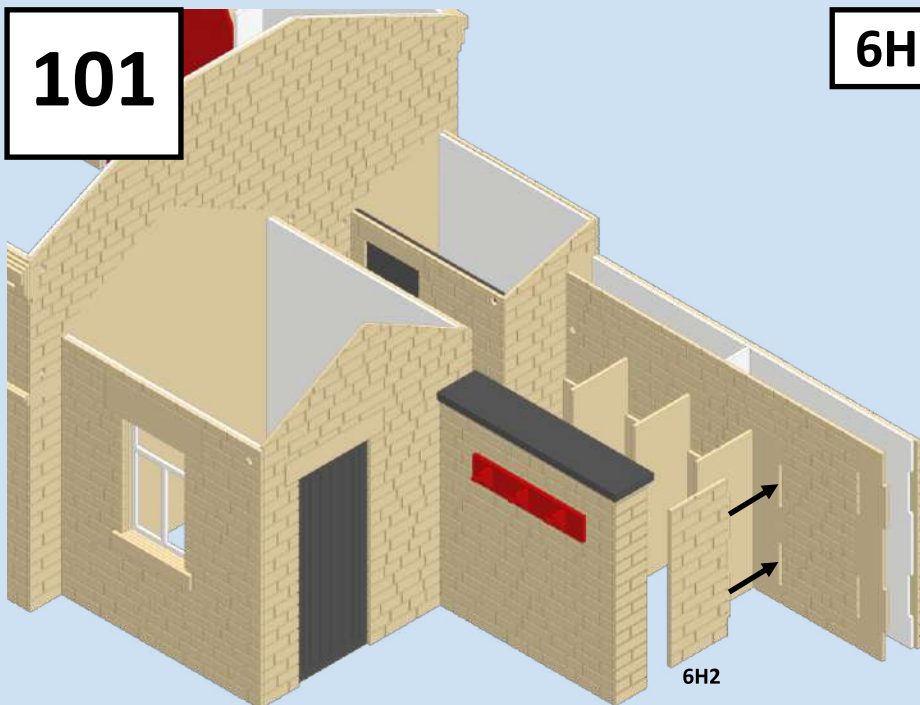

6H2

102

6H3 & 6H4

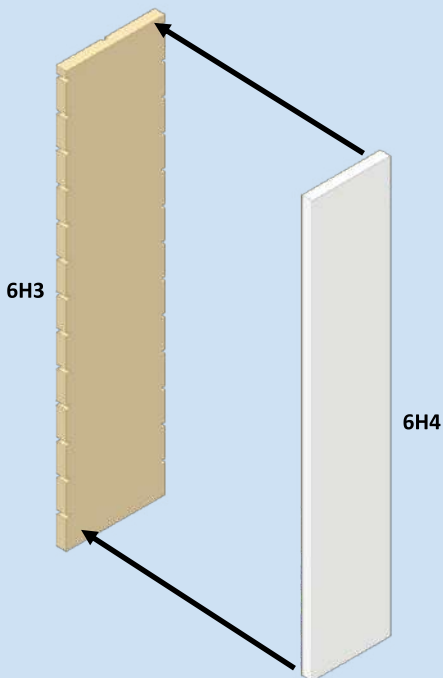

6H3

6H4

!



103

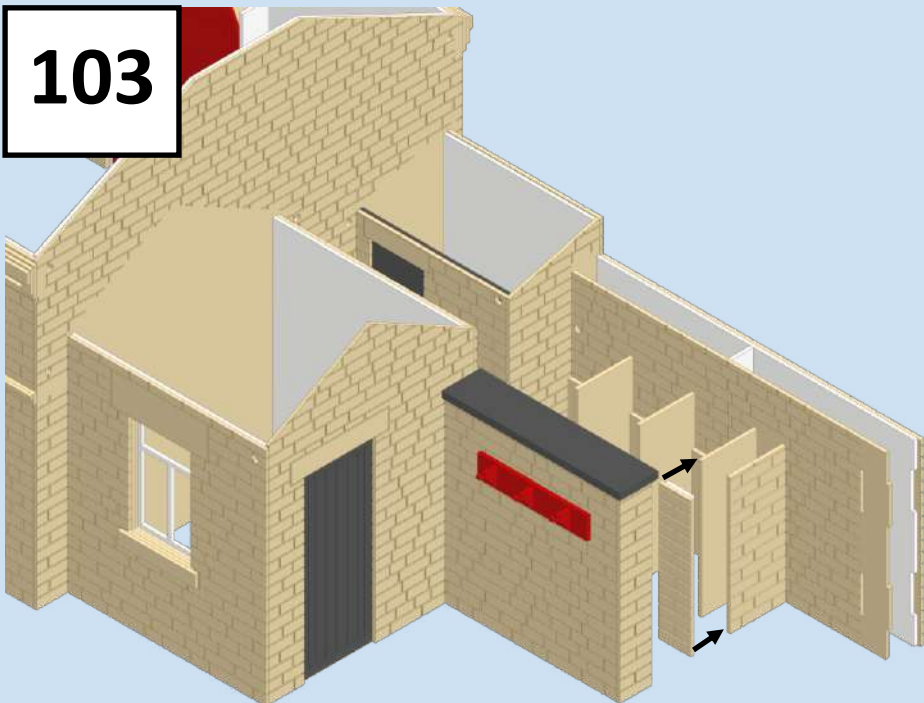

104

6J3(x2)

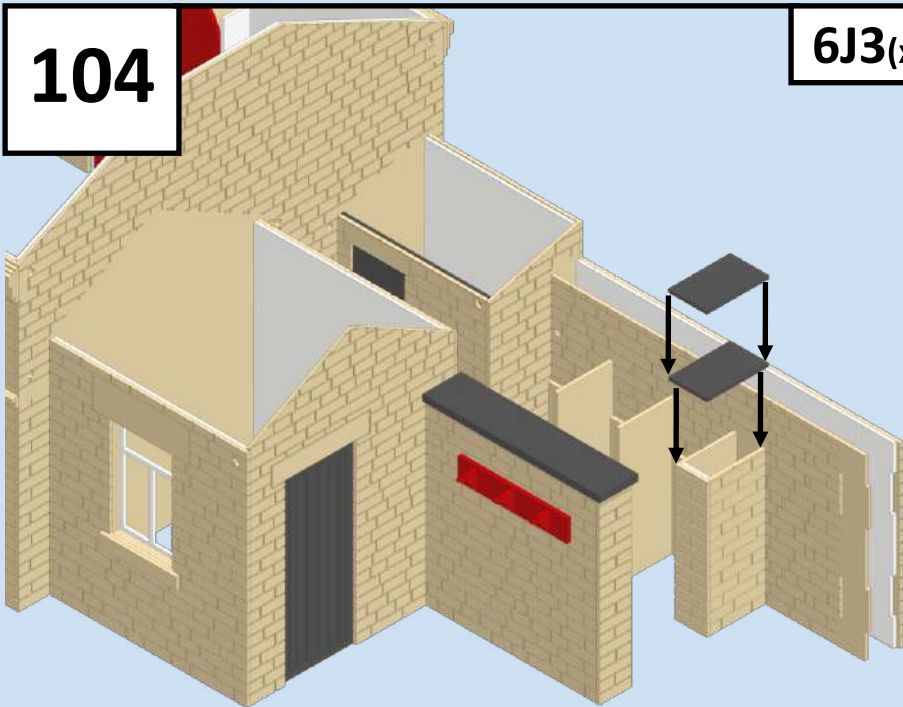

105

6E1 & 6E2

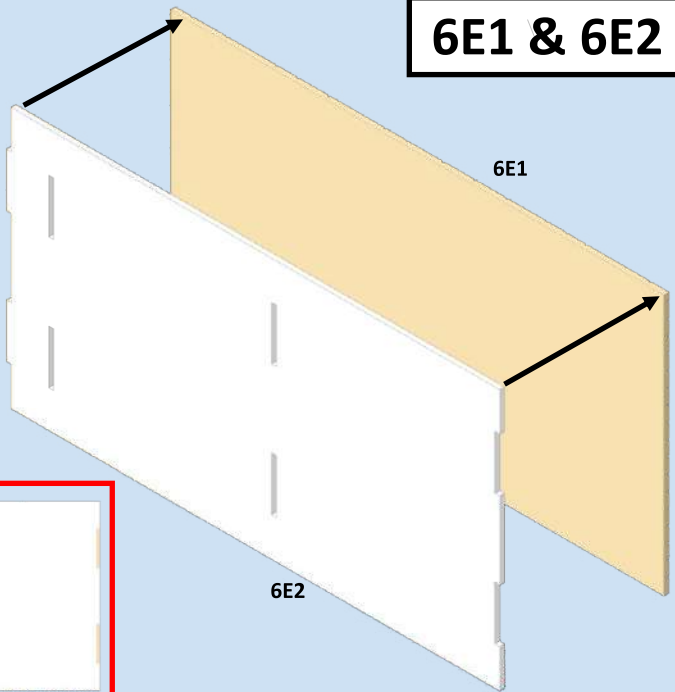

106

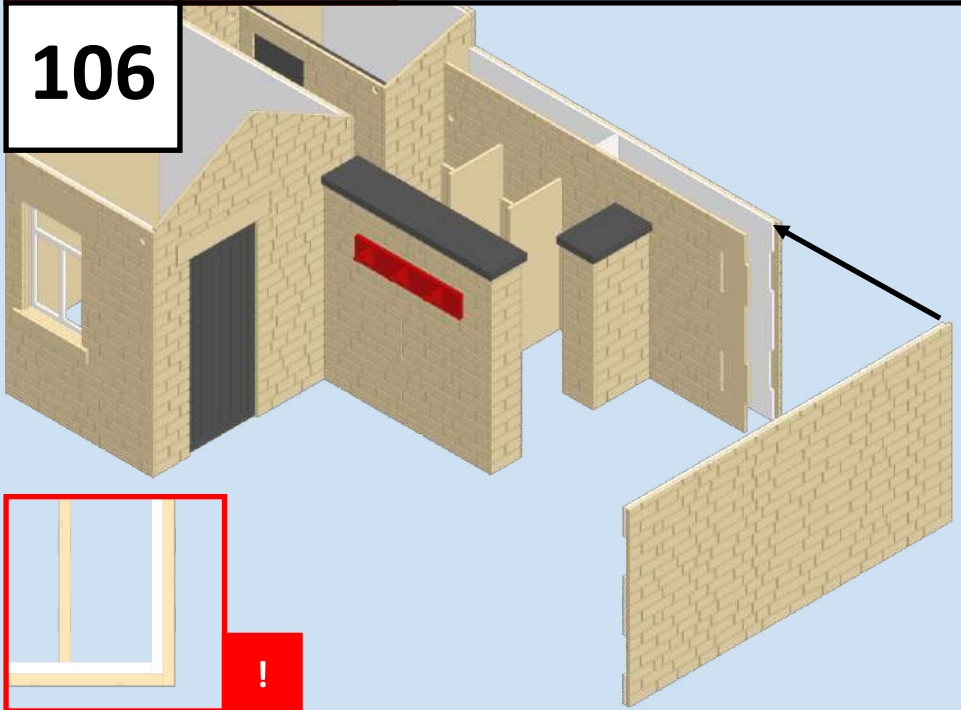

107

6G2



108

6F1

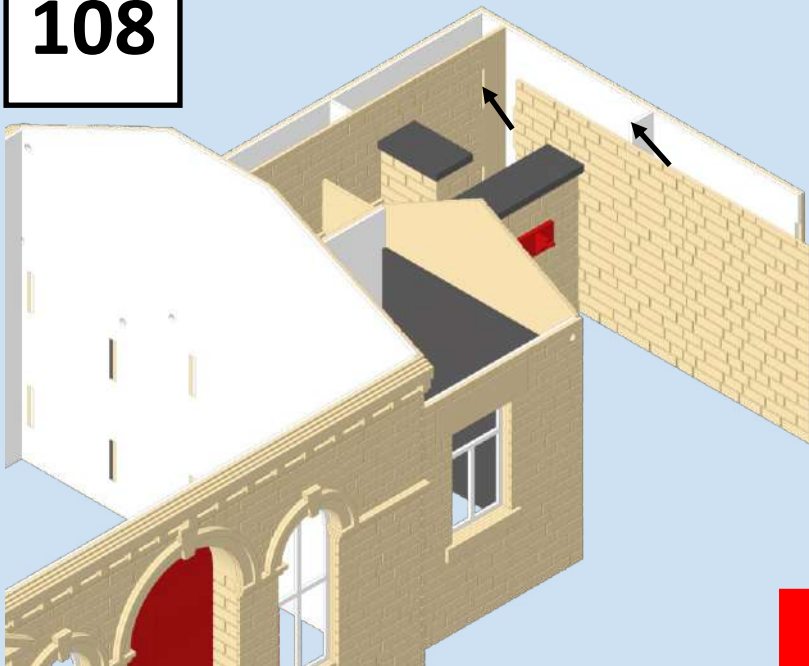

109



6G1 & 6G2

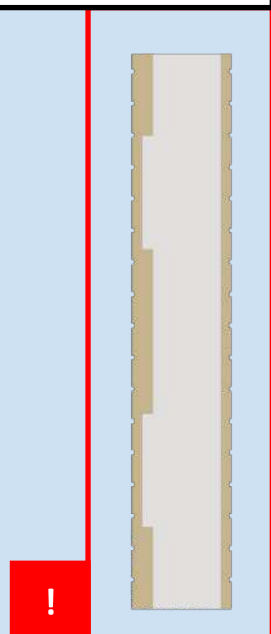

110

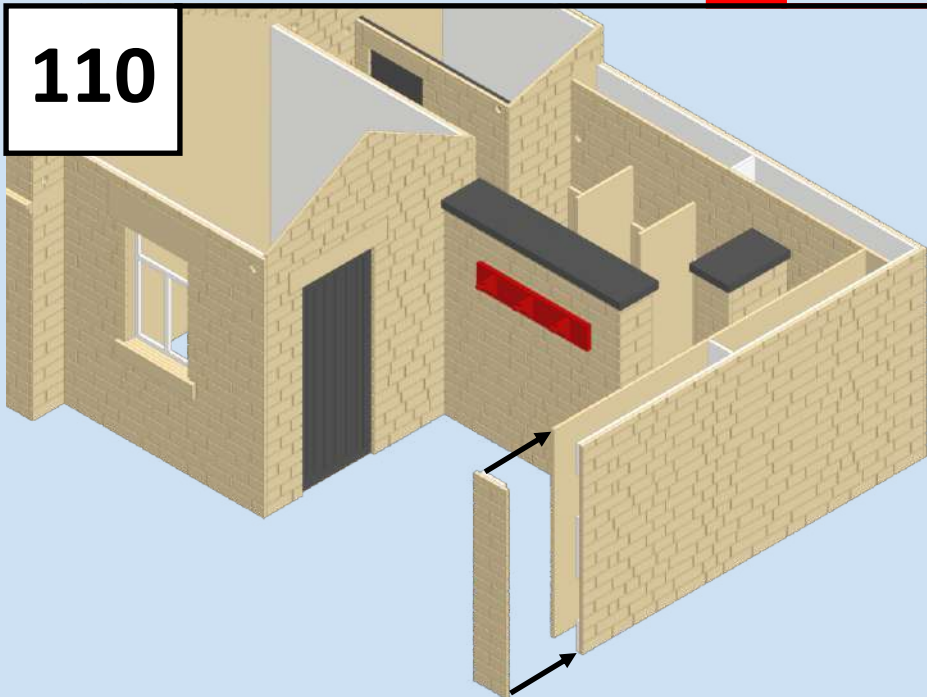

111

6J2(x2)

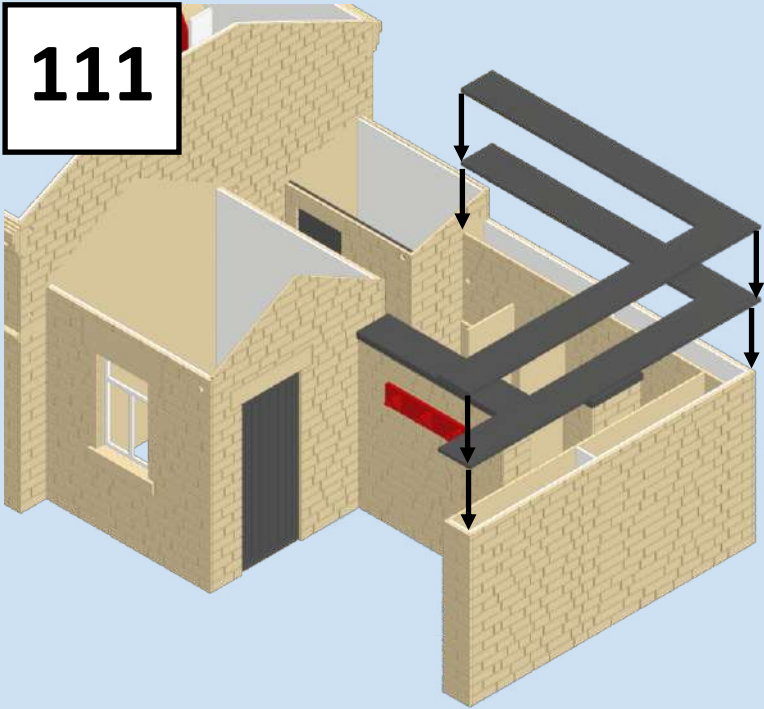

112

6J1

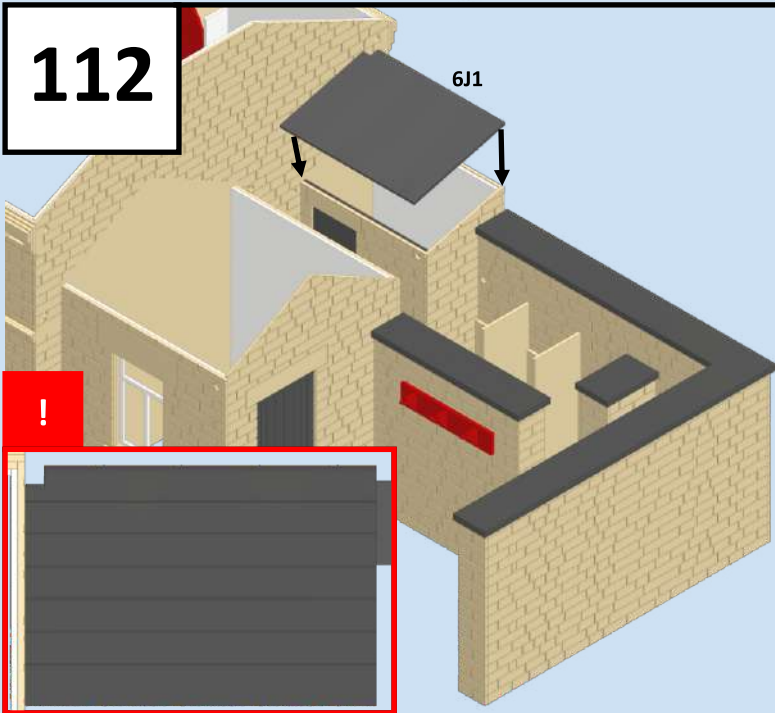

113

5J1

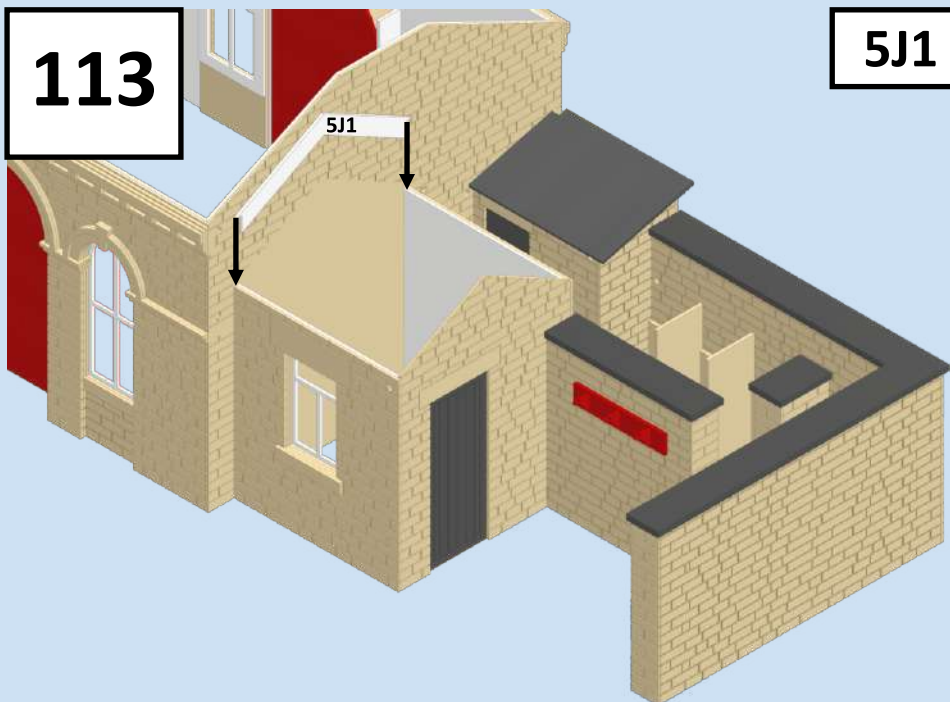

114

5F1

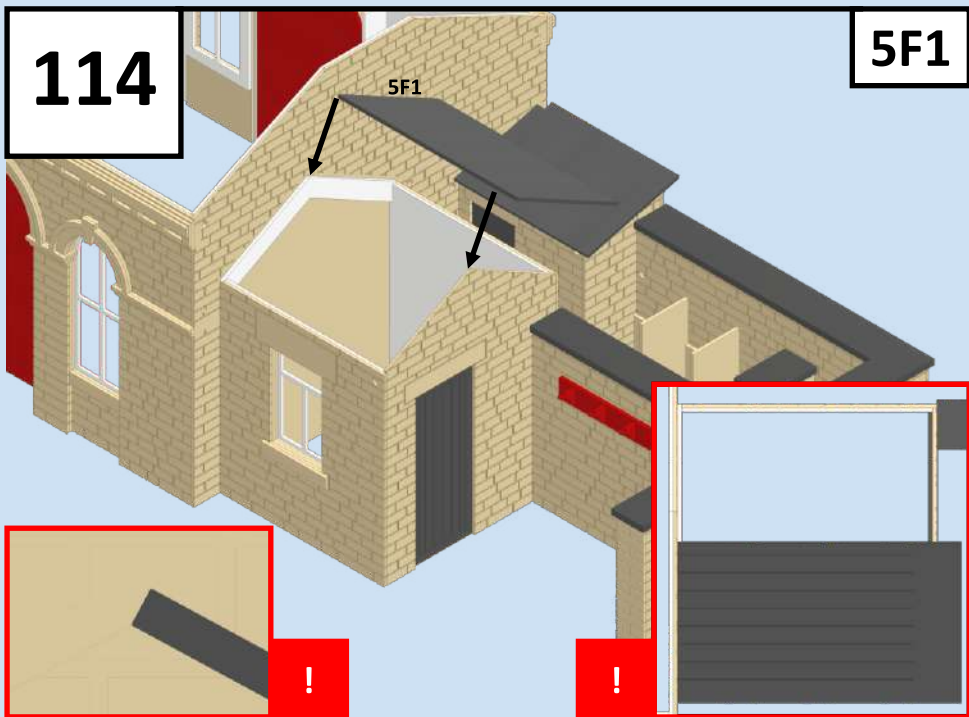

115

5F1

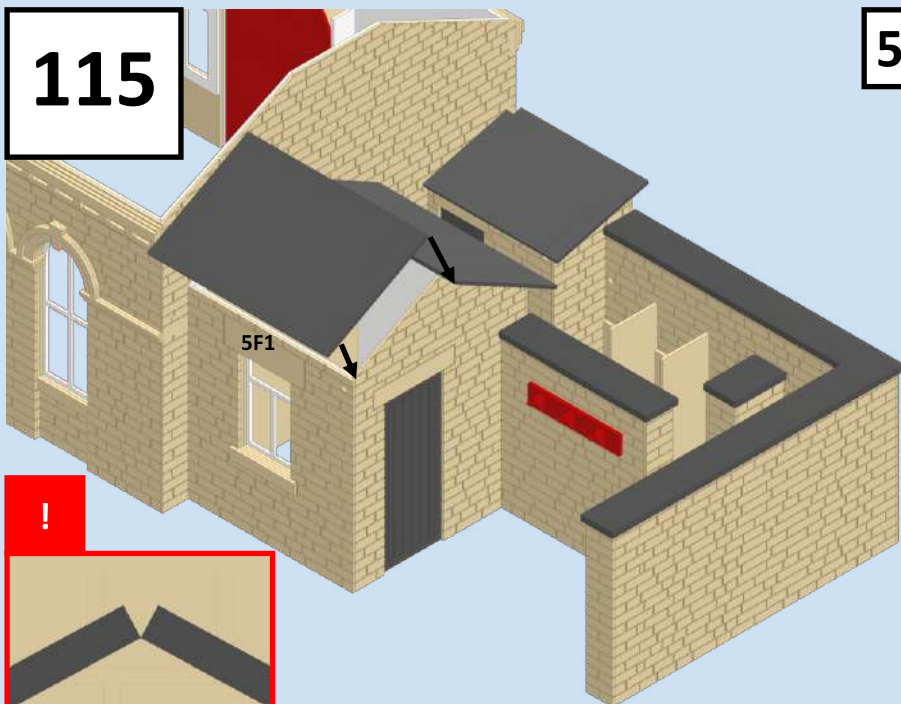

116

A4

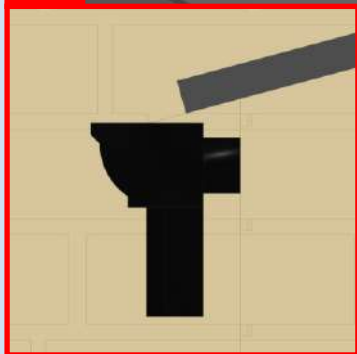
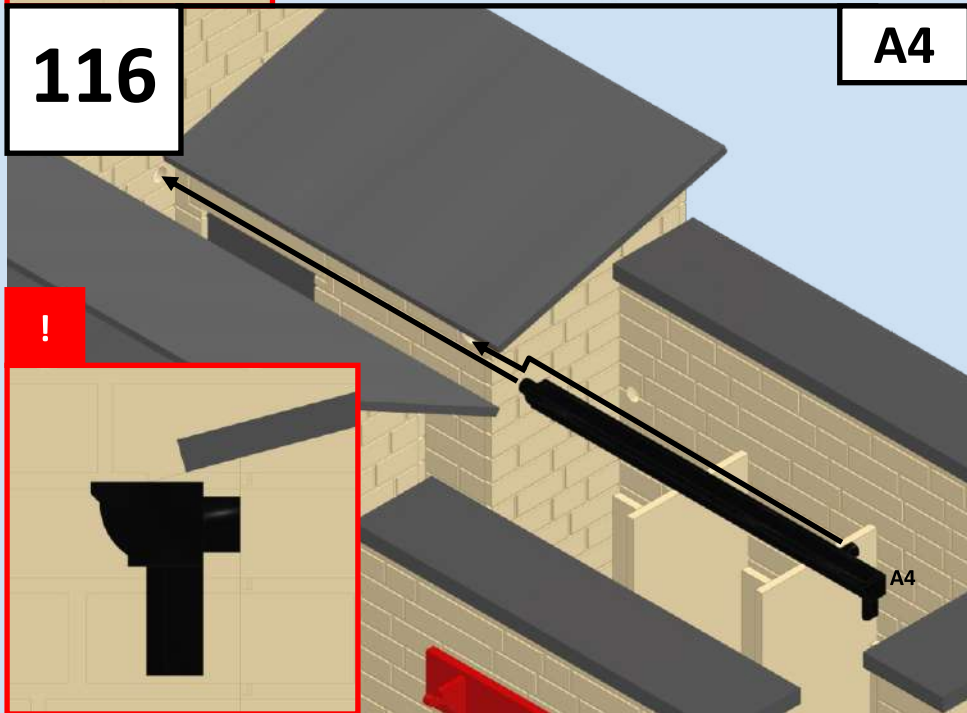

117

A4-5

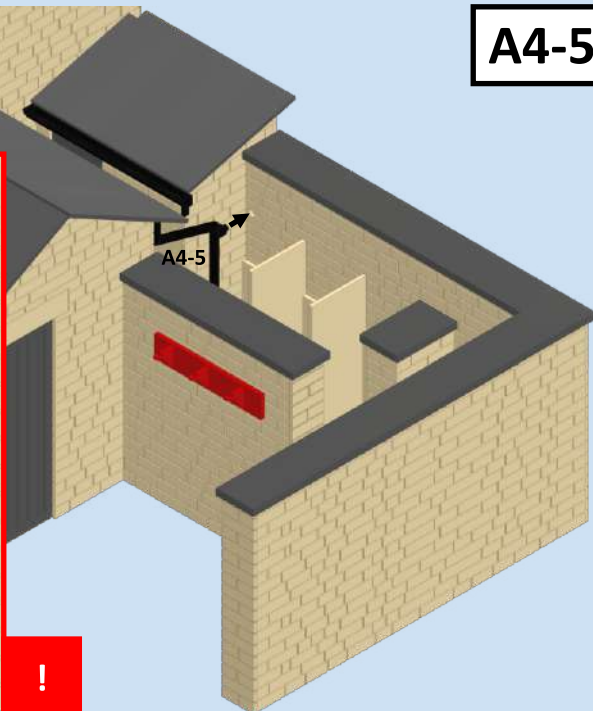
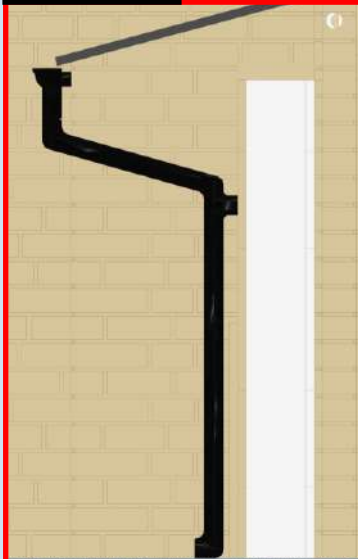

118

A5

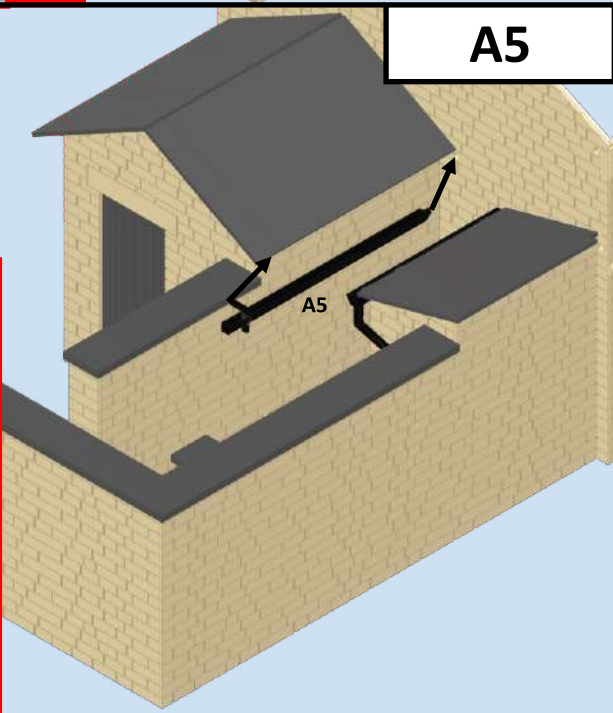
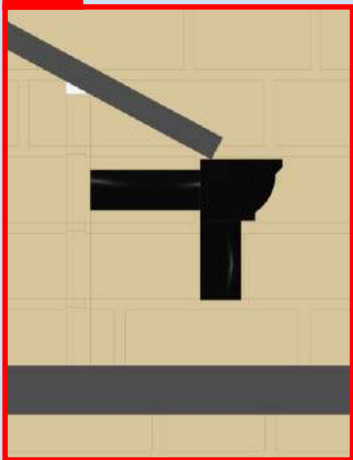

119

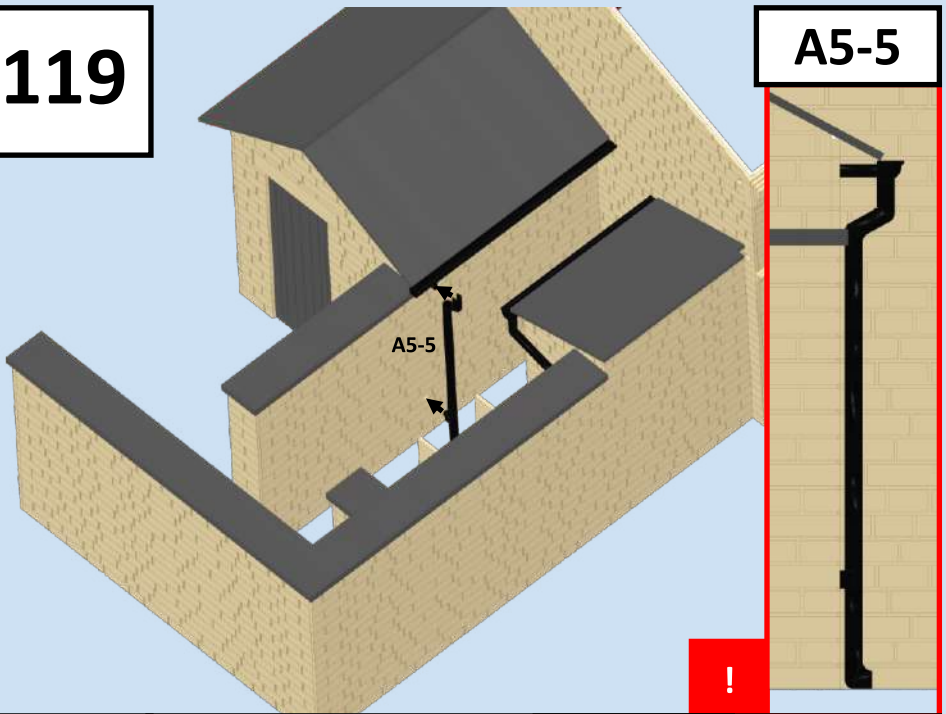

A5-5

A5-5

!

120

1E4, 1E5 & 1E6

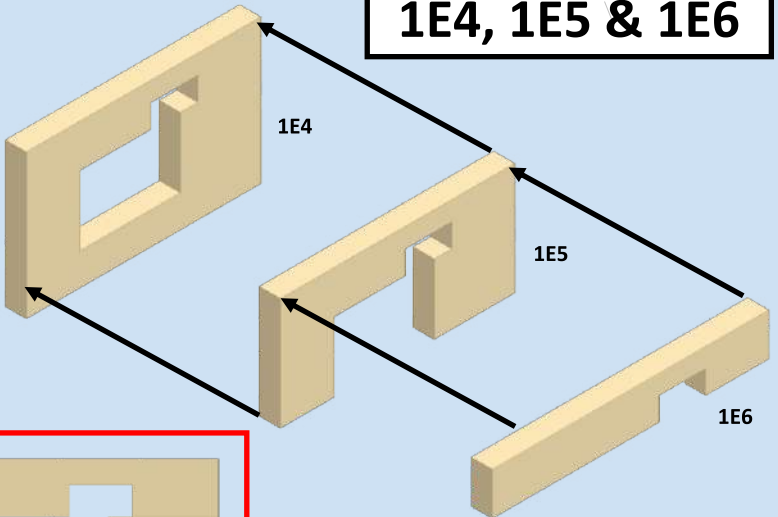

1E4

1E5

1E6

!

121

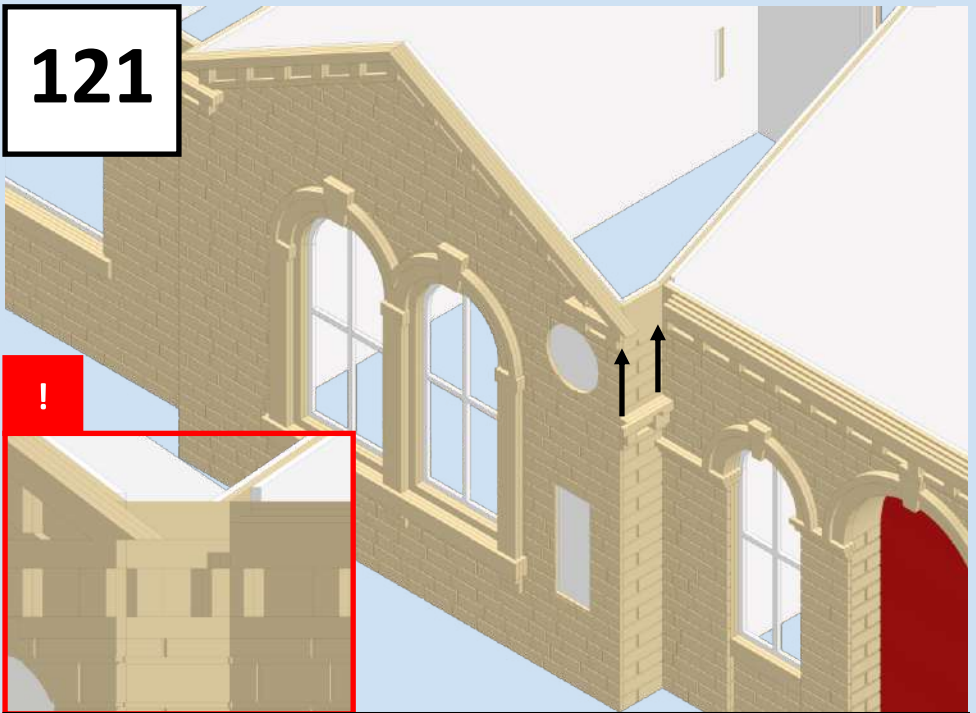

122

1E4, 1E5 & 1E6

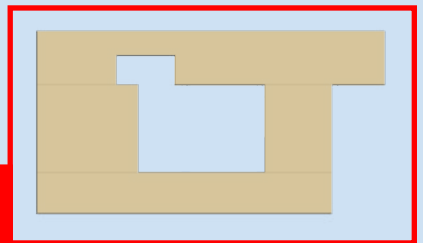
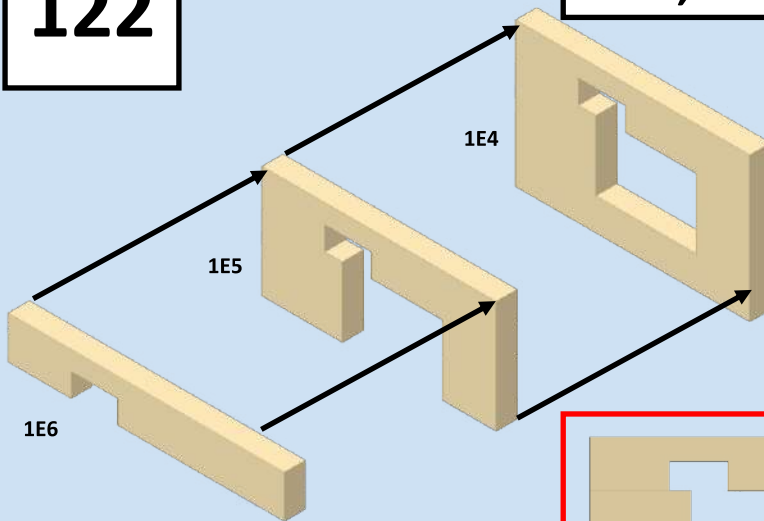

123



124

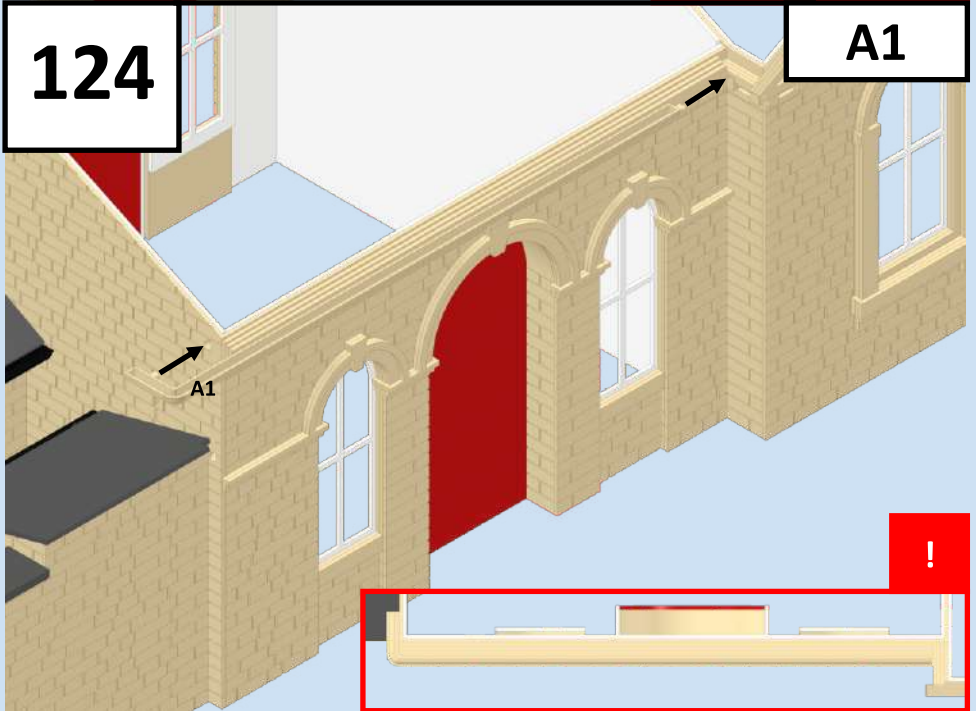

A1

125

A1-5

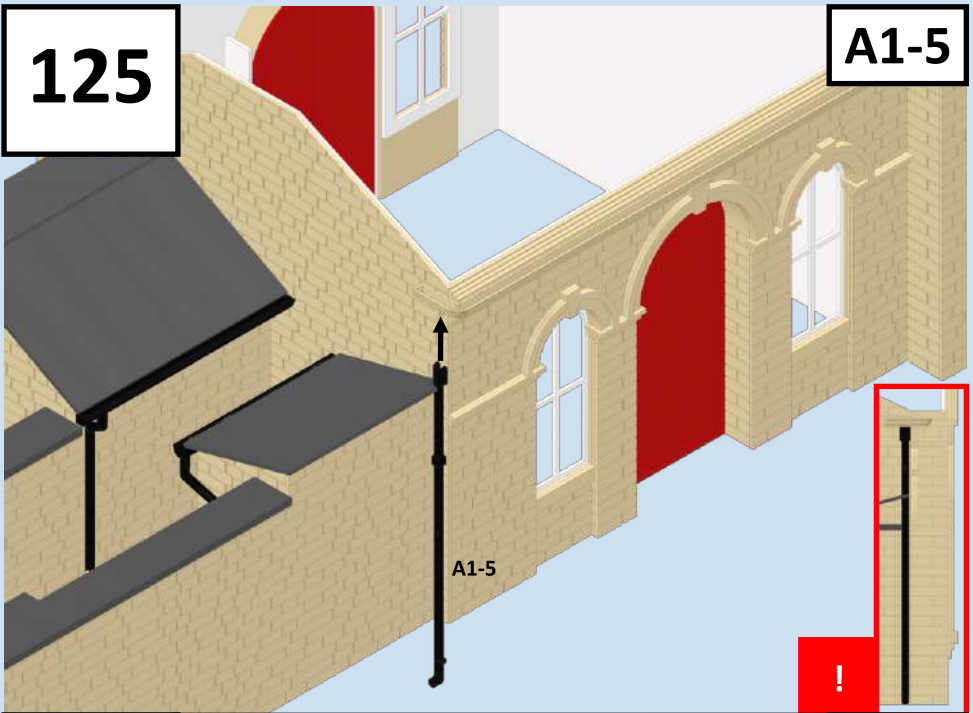

126

A2

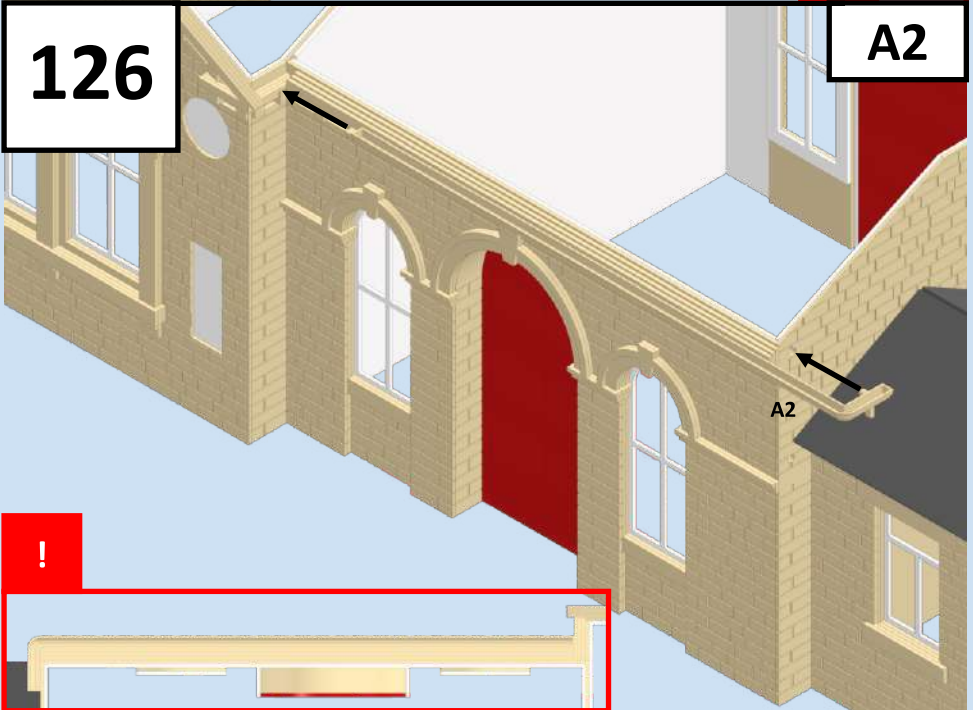

127

A1-5

A1-5

128

A3

A3

!

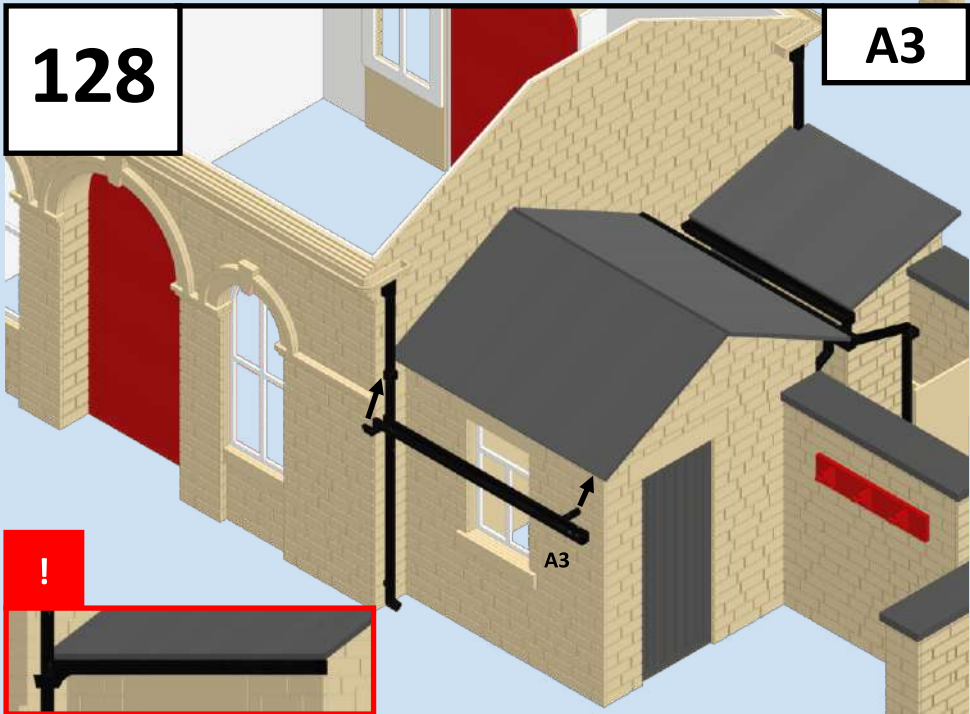
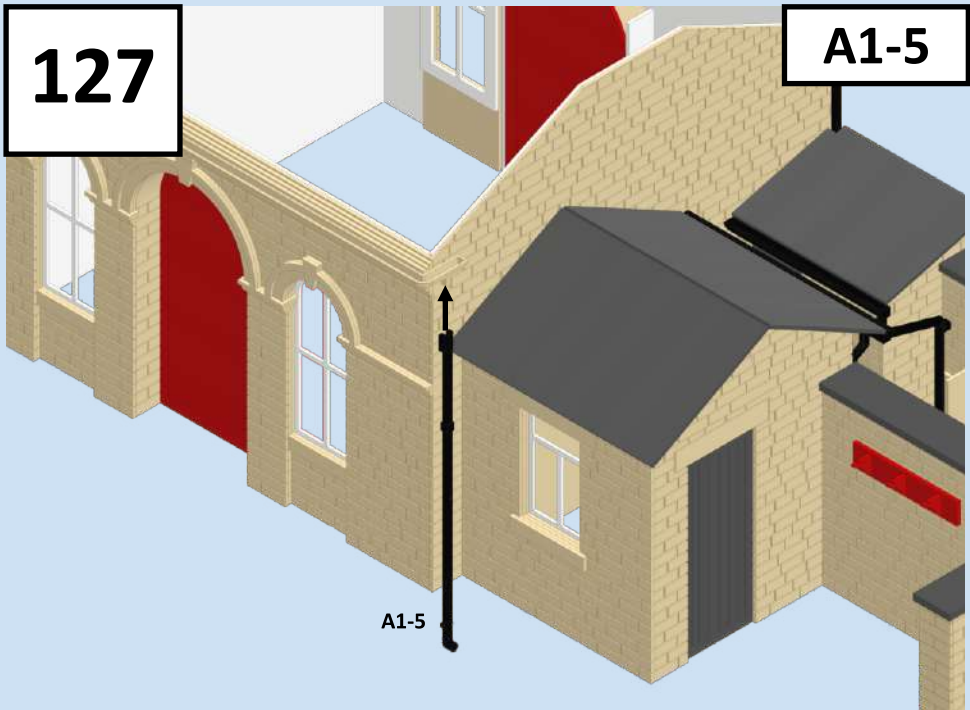

129

Tiles

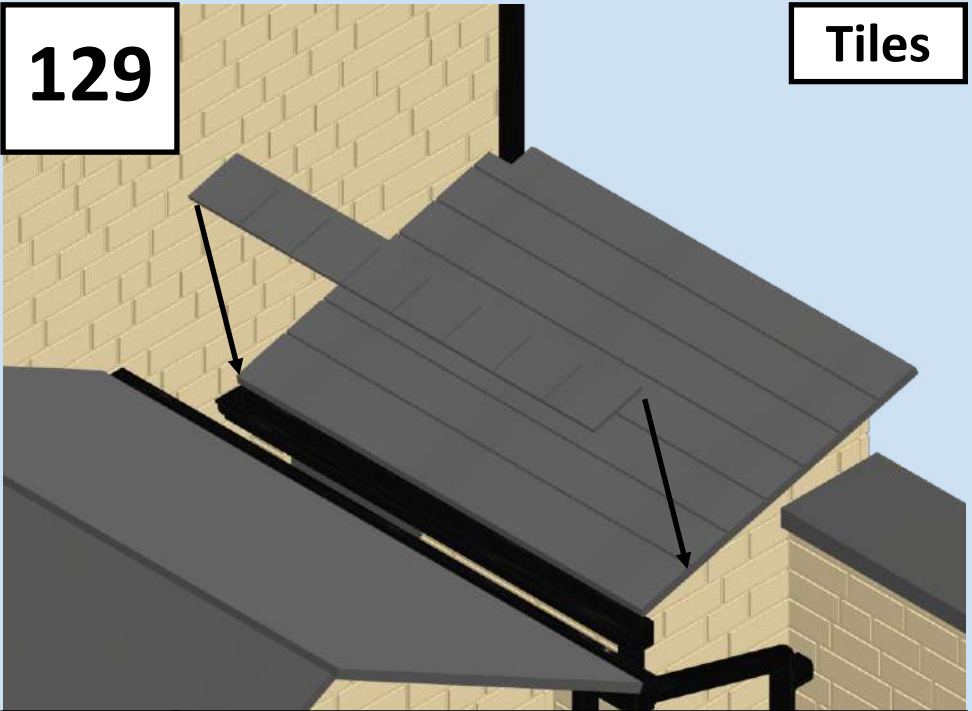

130

Tiles

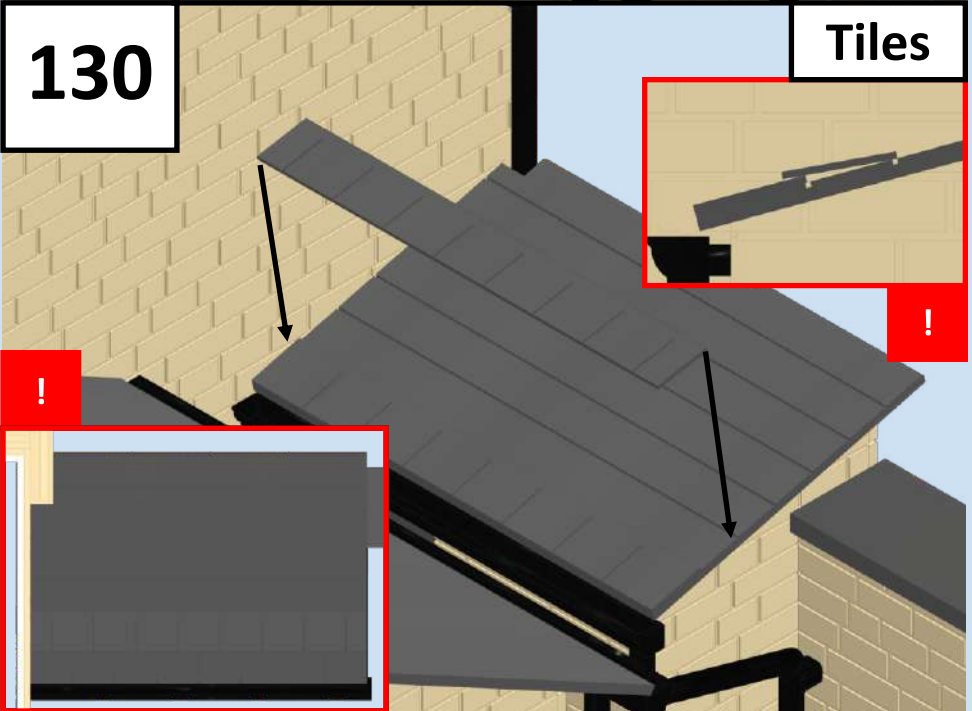

131

Tiles

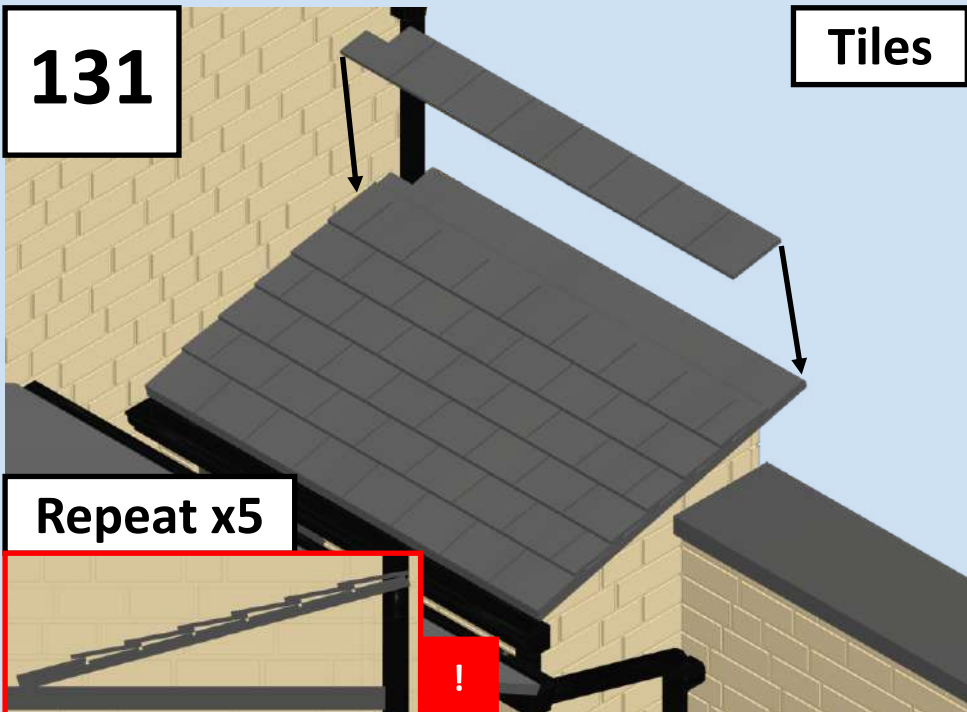

Repeat x5

132

Tiles

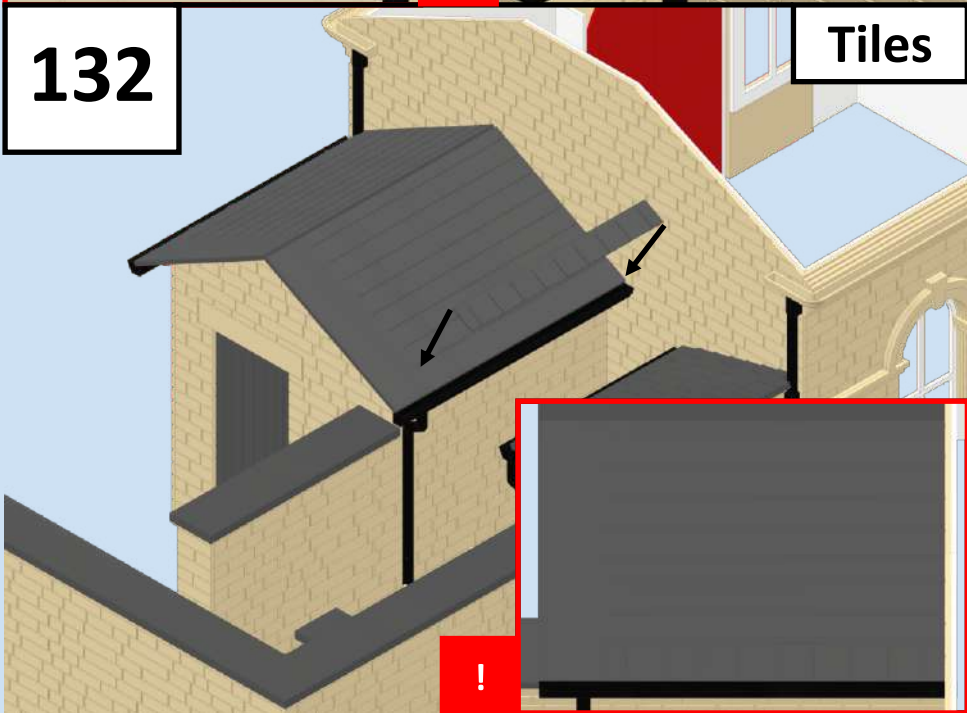

133

Tiles

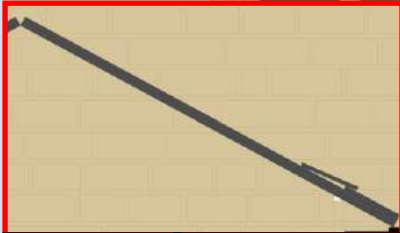

134

Tiles

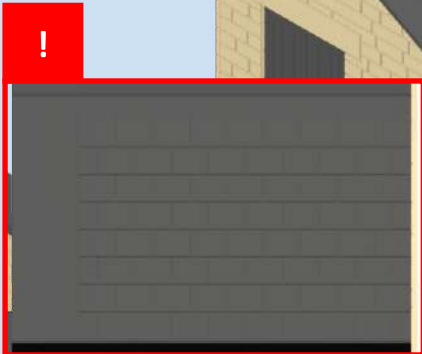

Repeat x6

135

Tiles

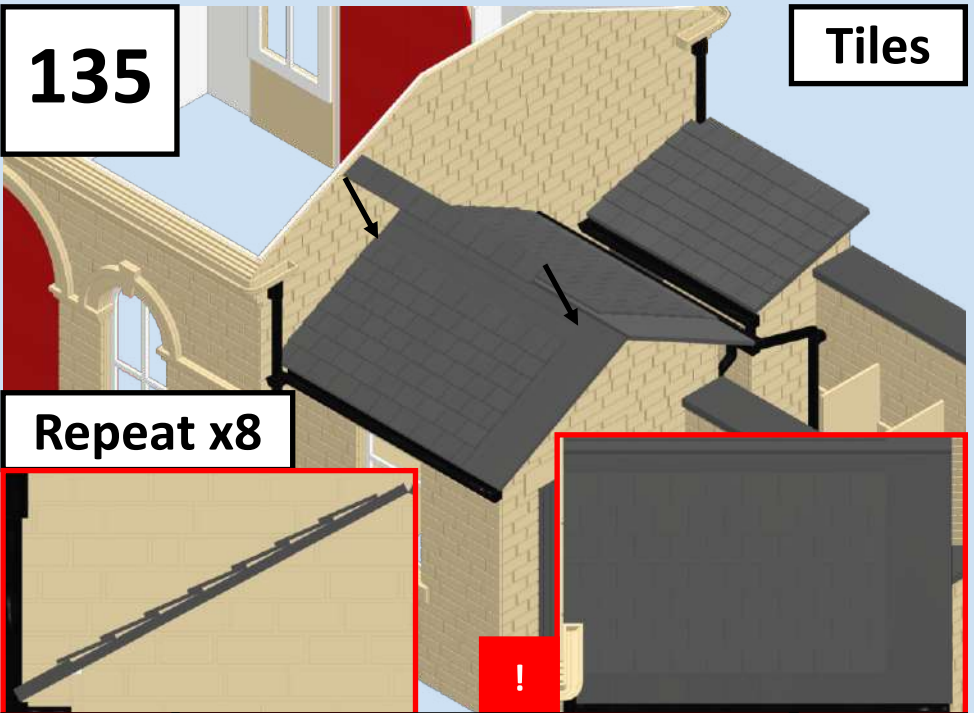

Repeat x8

136

Tiles

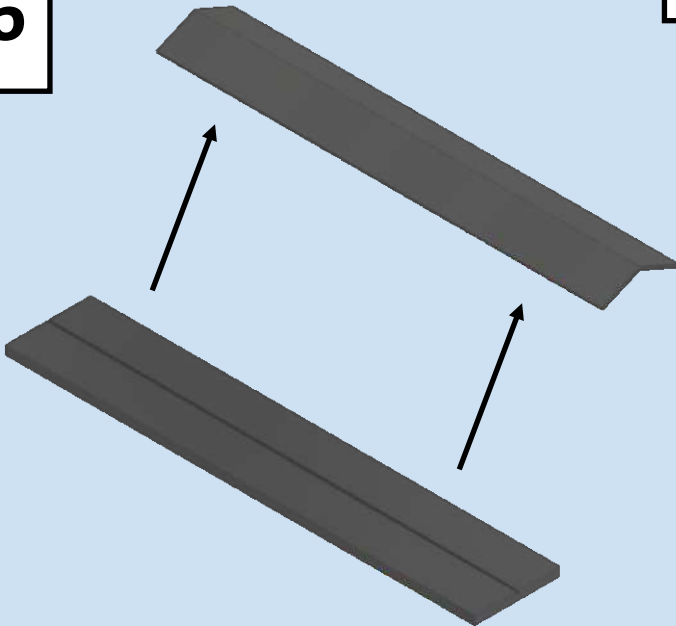

137

Tiles

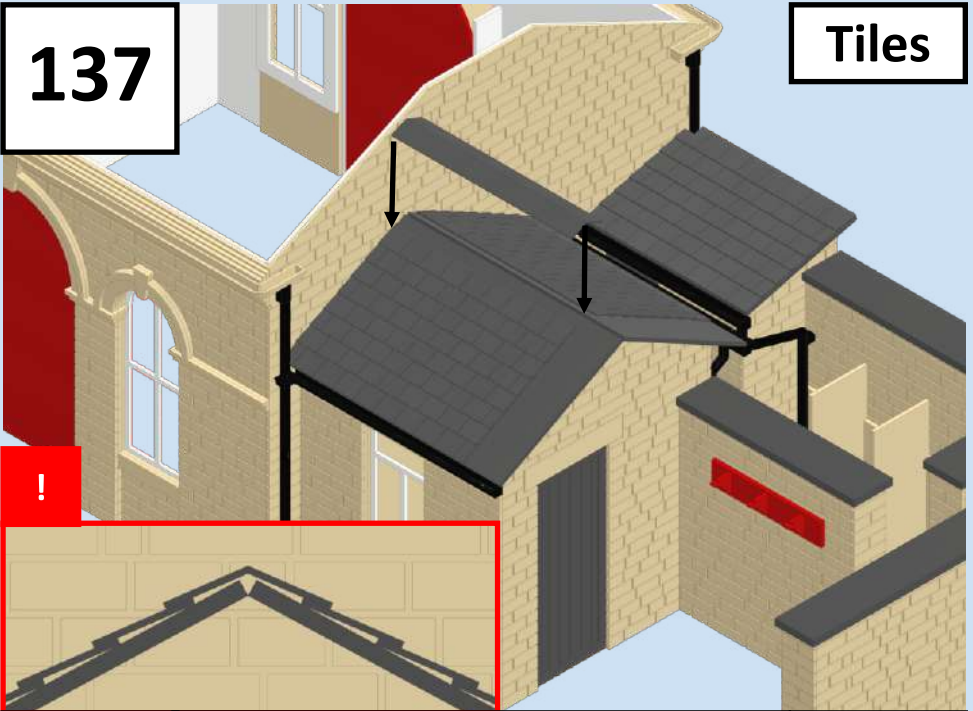

138

5F2(x2)

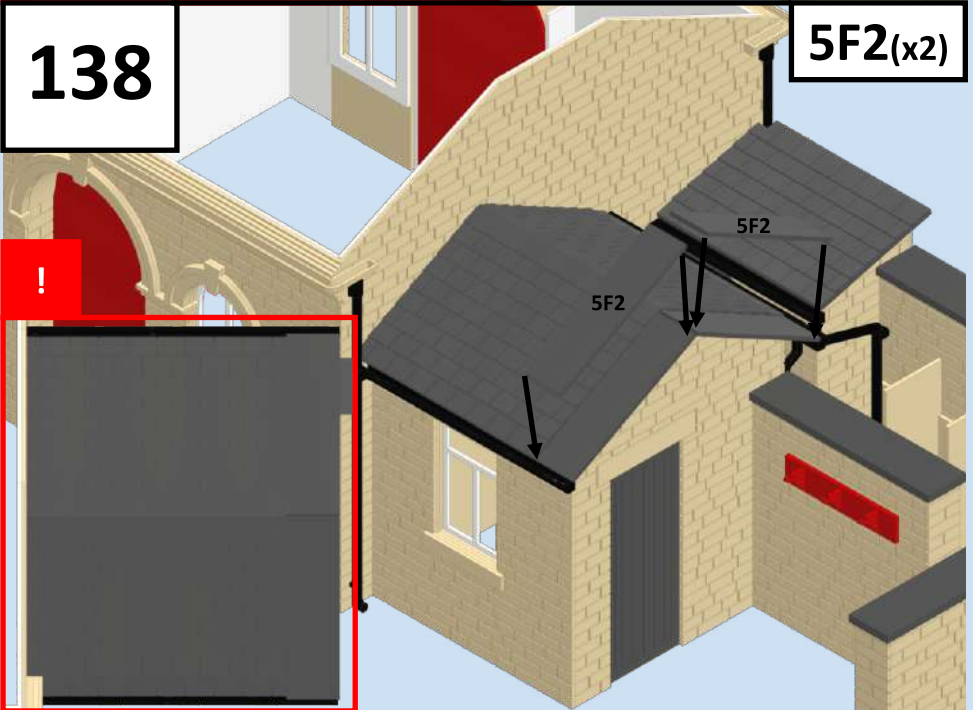

139

1F1

1F1



140

1F2

1F2



141

2F1

2F1

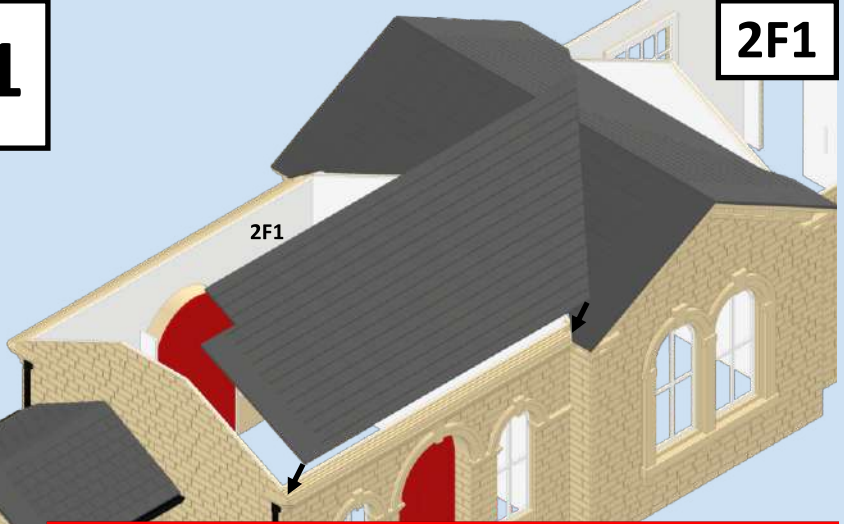

142

2F2

2F2

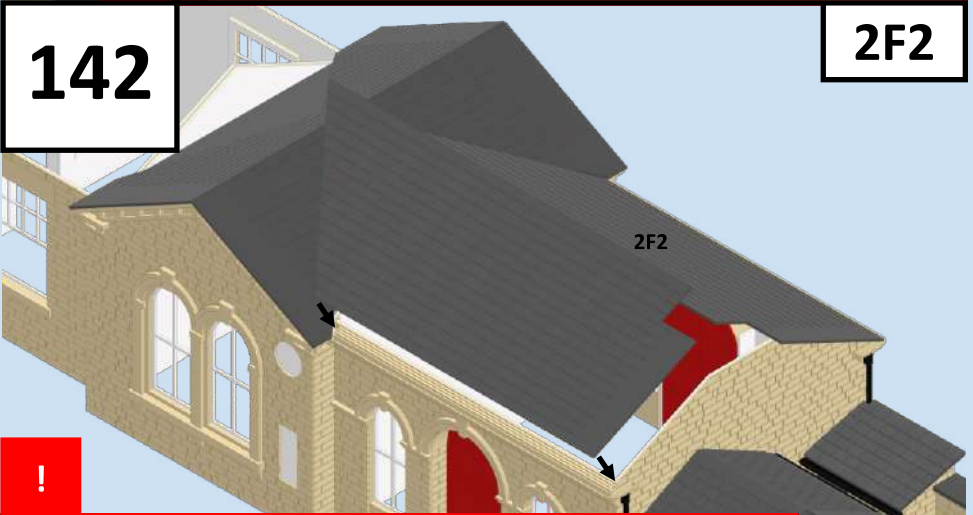

143

3F1



144

3F2



!

145

3F3

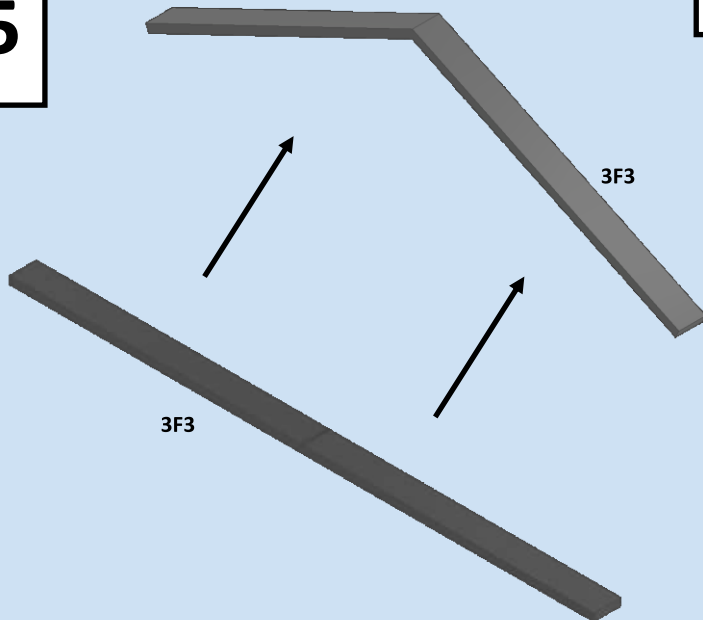

146

3F3



!



147

3F4

3F4



148

1F3(x2)

1F3

1F3



149

1F4(x2)

1F4

1F4

!



150

7B1 & 7B3

7B3

7B1



X4

151

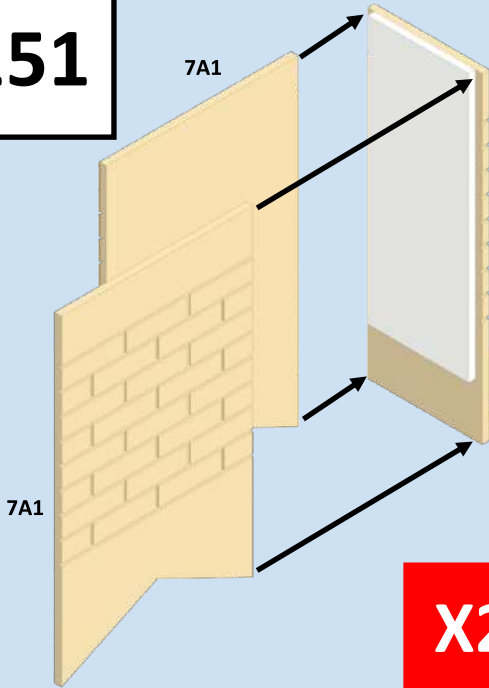

7A1(x2)

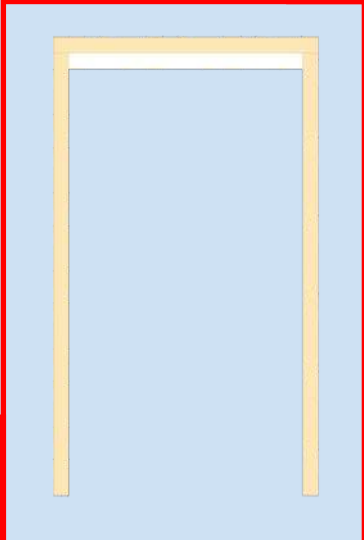

X2

152

!

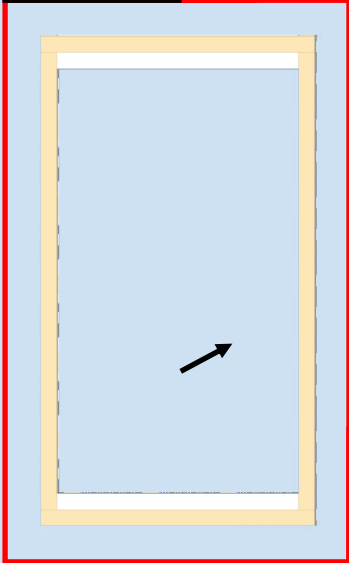

7B1 & 7B3

X2

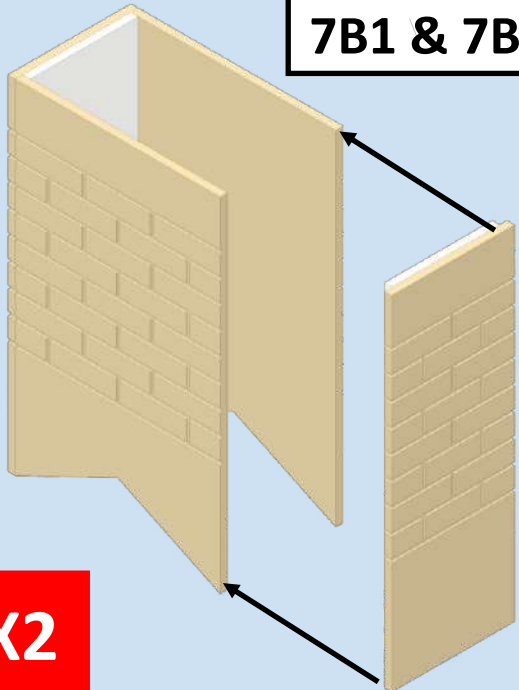

153

J6 & J7(x2)

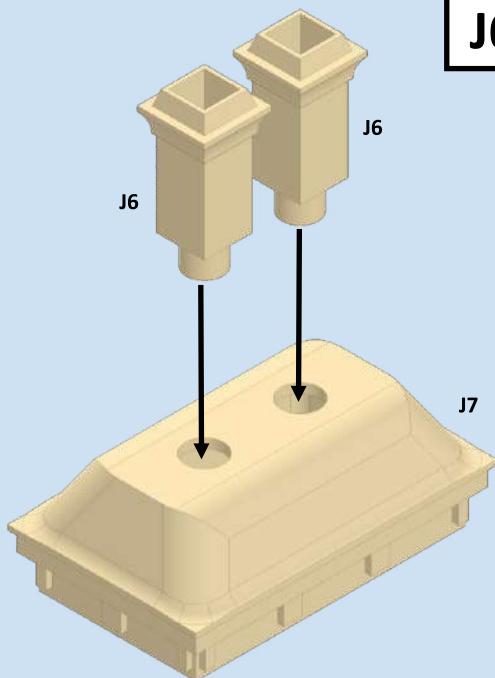

X2

154

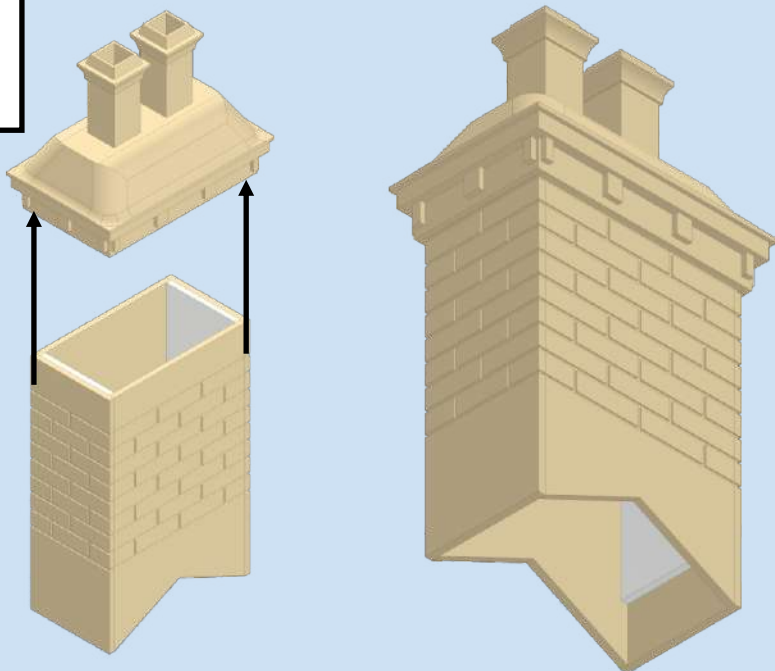

X2

155

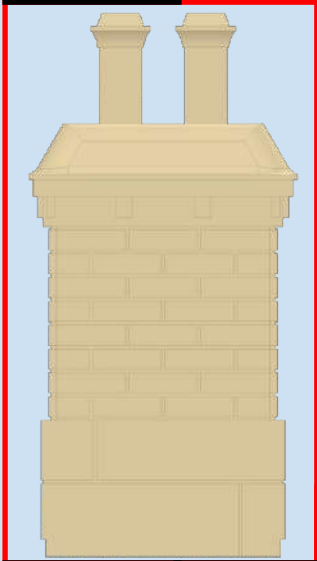

7A3

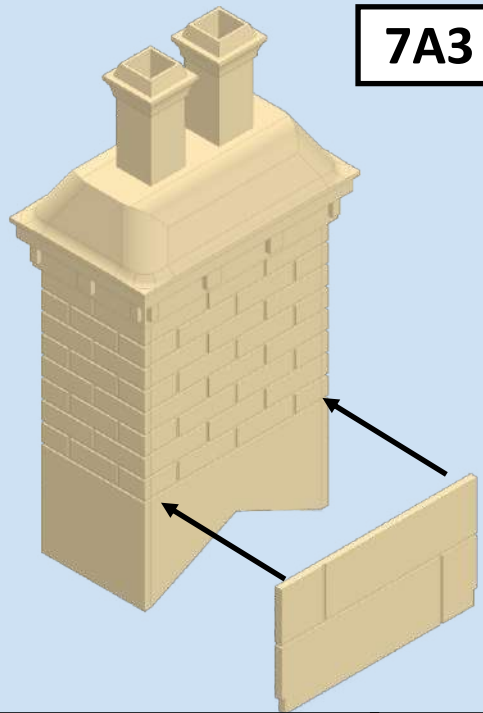

156

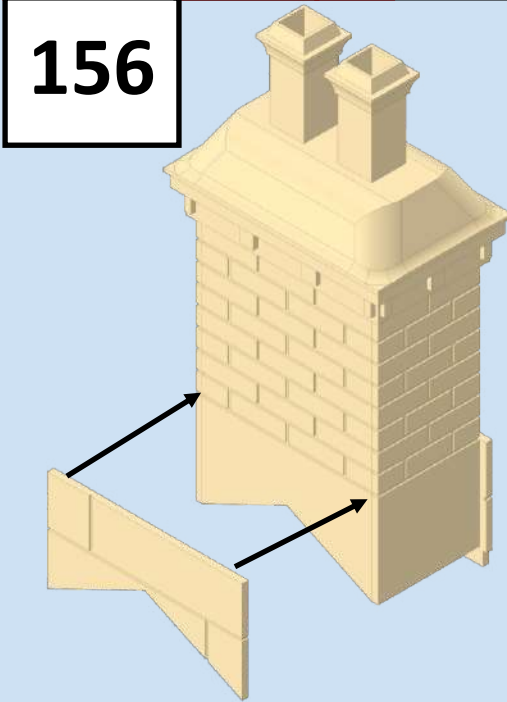

7A2

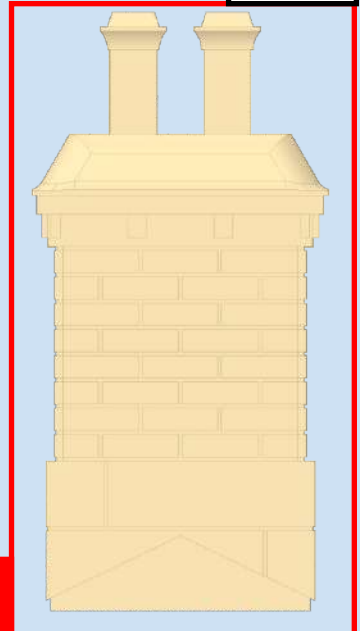

157

7B2

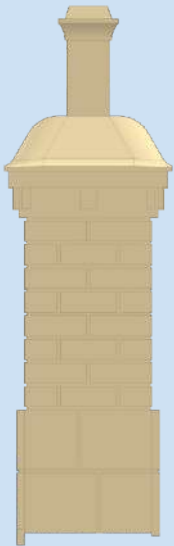

!

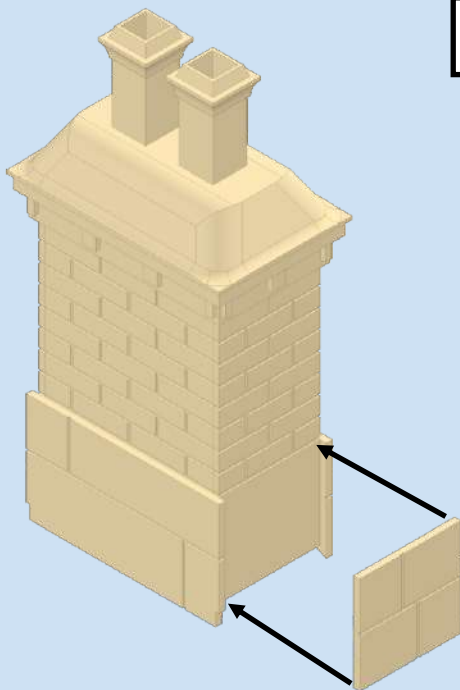

7B2

158

7B2

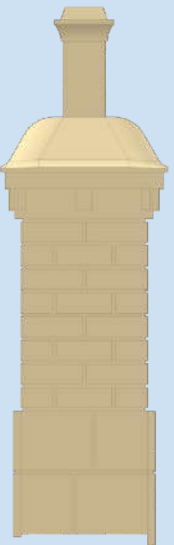

!

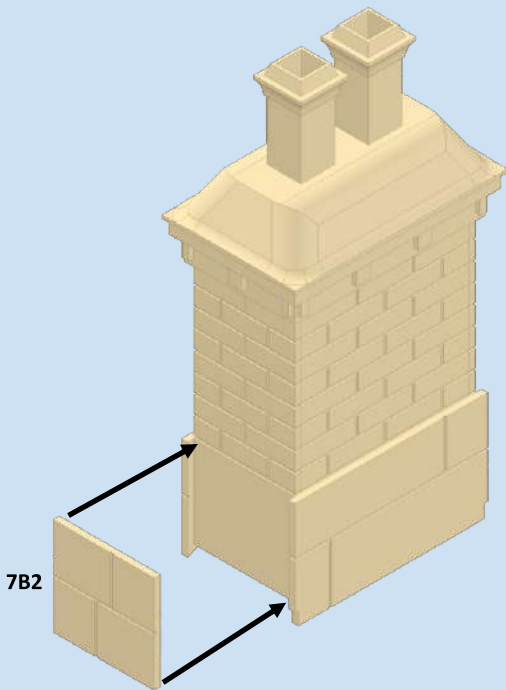

7B2

159

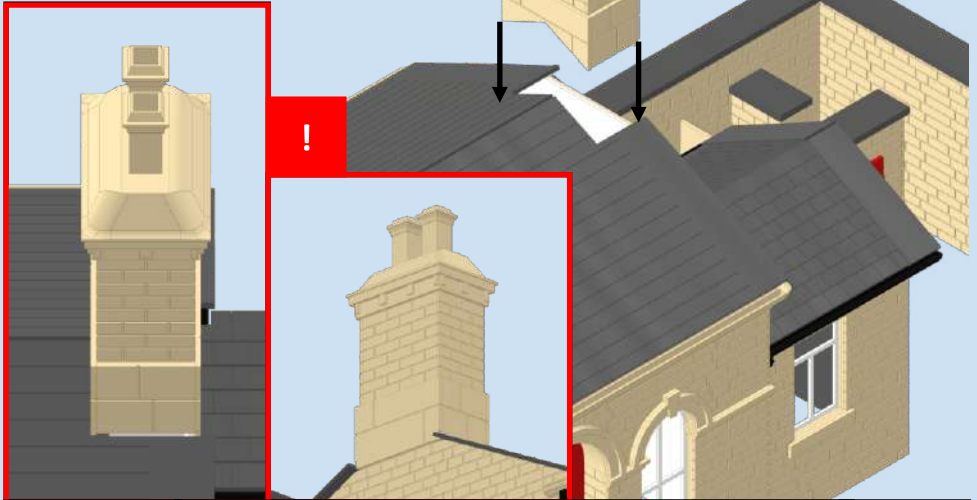

160

7A2

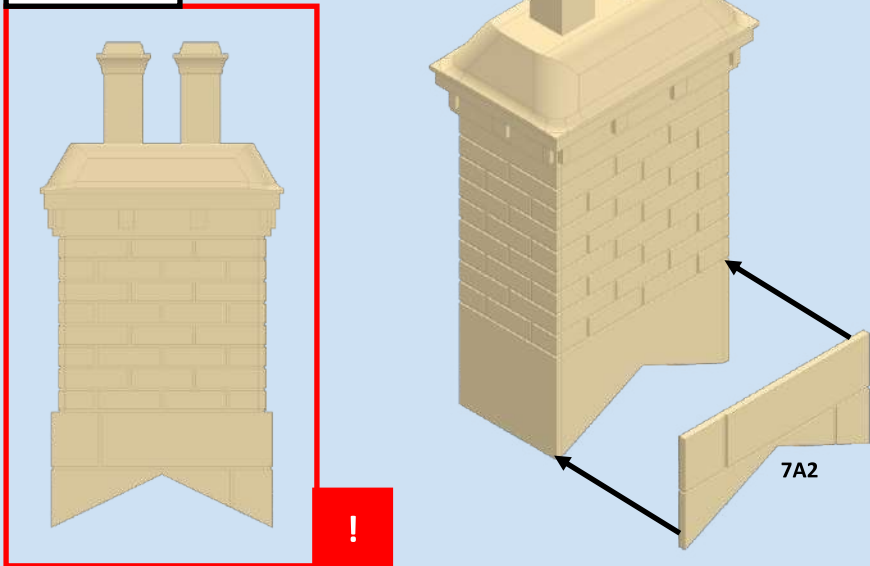

161

7A2

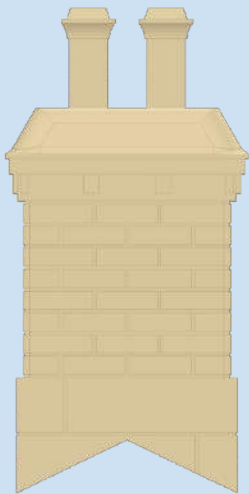

!

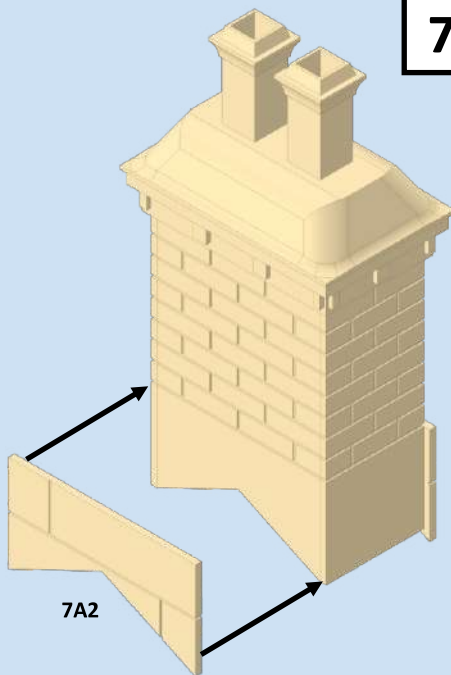

162

7B2

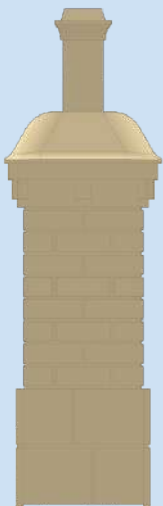

!

7B2

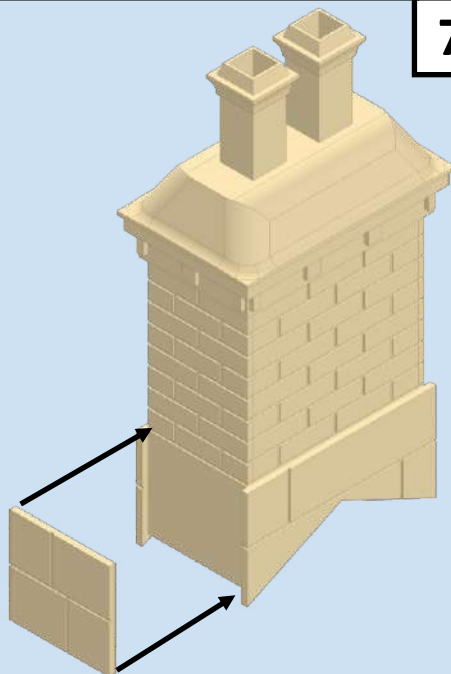

163

7B2

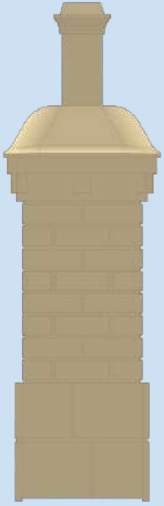

!

7B2

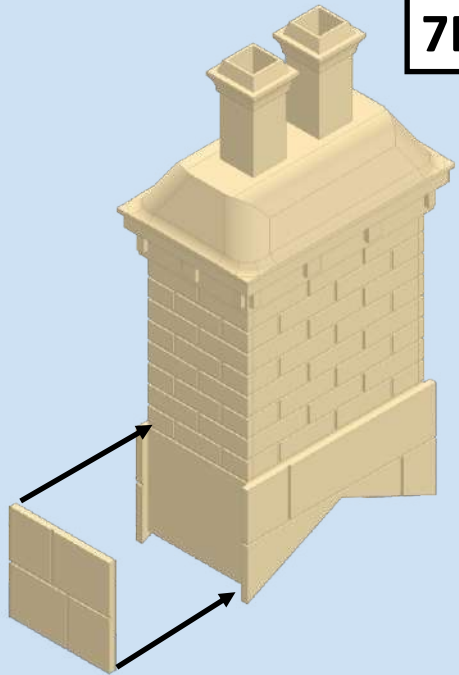

164

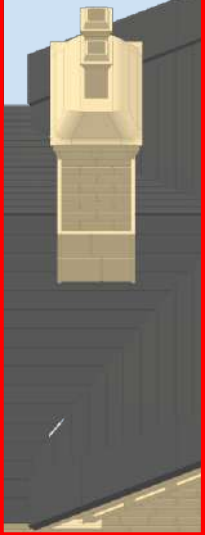

!



165

2F3

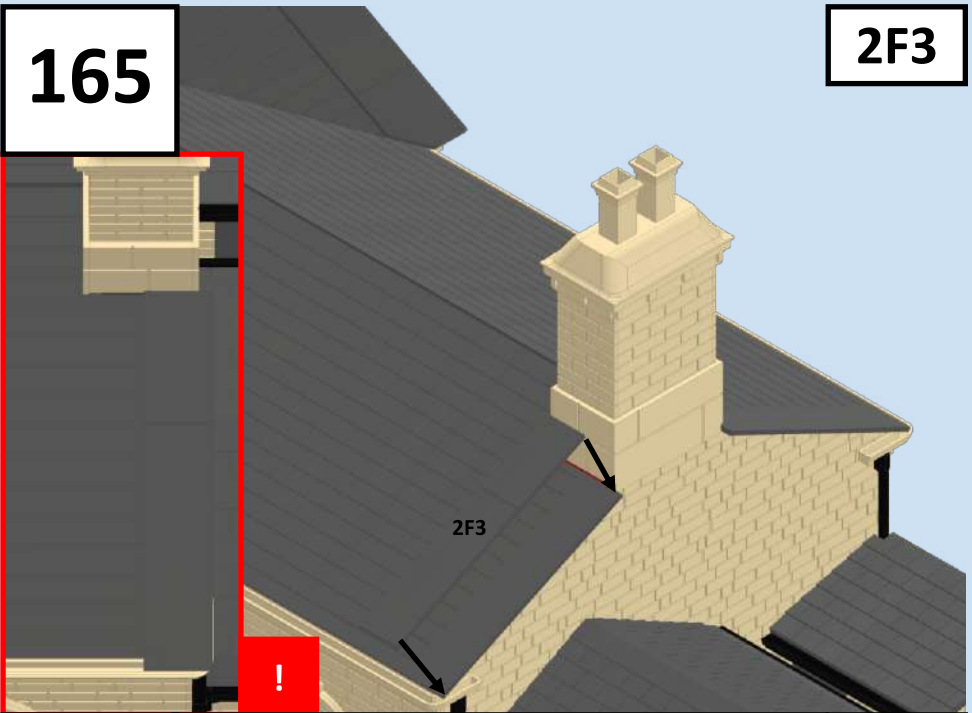

166

2F3



167

1F1 Roof Tiles

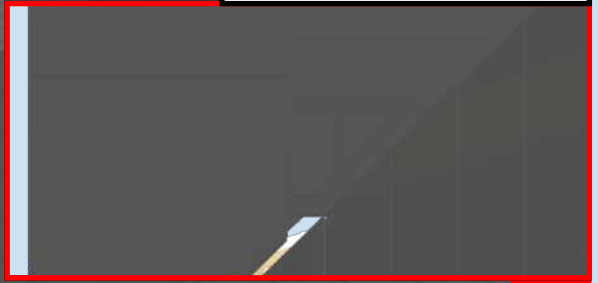

!

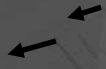

168

1F1 Roof Tiles



!

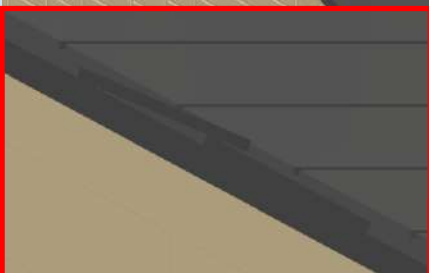

!

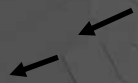

169

1F1 Roof Tiles

Repeat x10

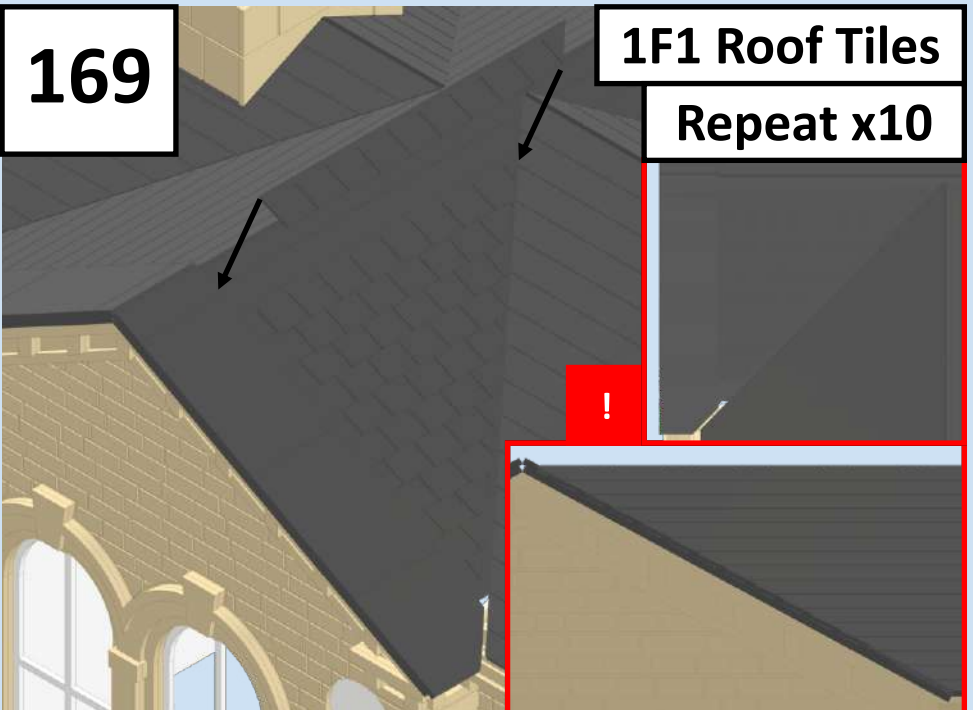

170

1F1 Roof Tiles

Repeat x12

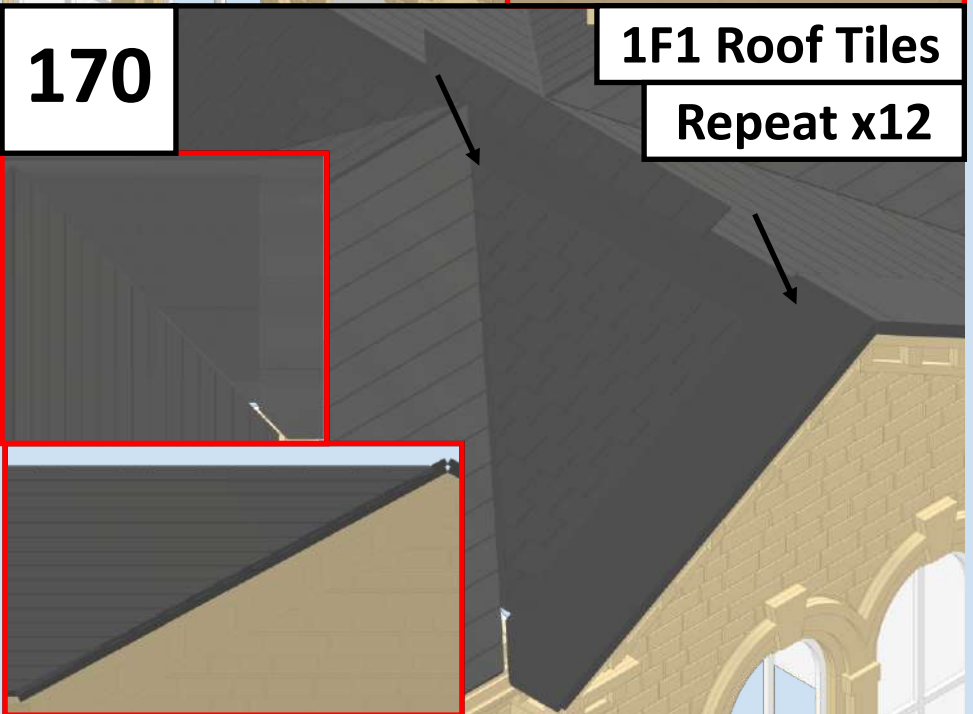

171

1F1 Roof Tiles



172

2F1 Roof Tiles

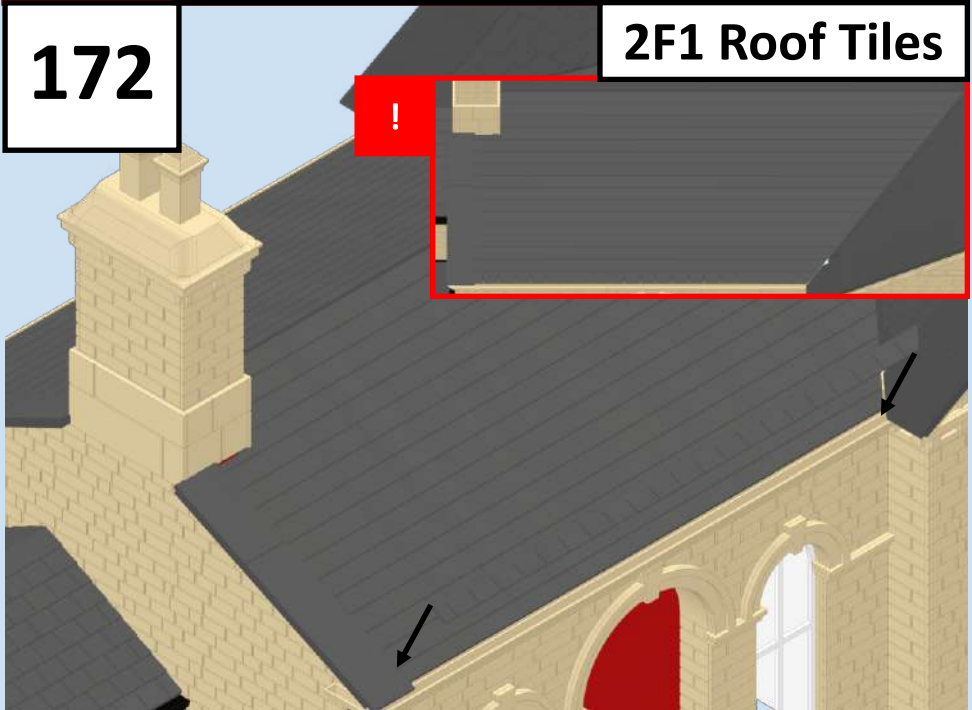

173

2F1 Roof Tiles

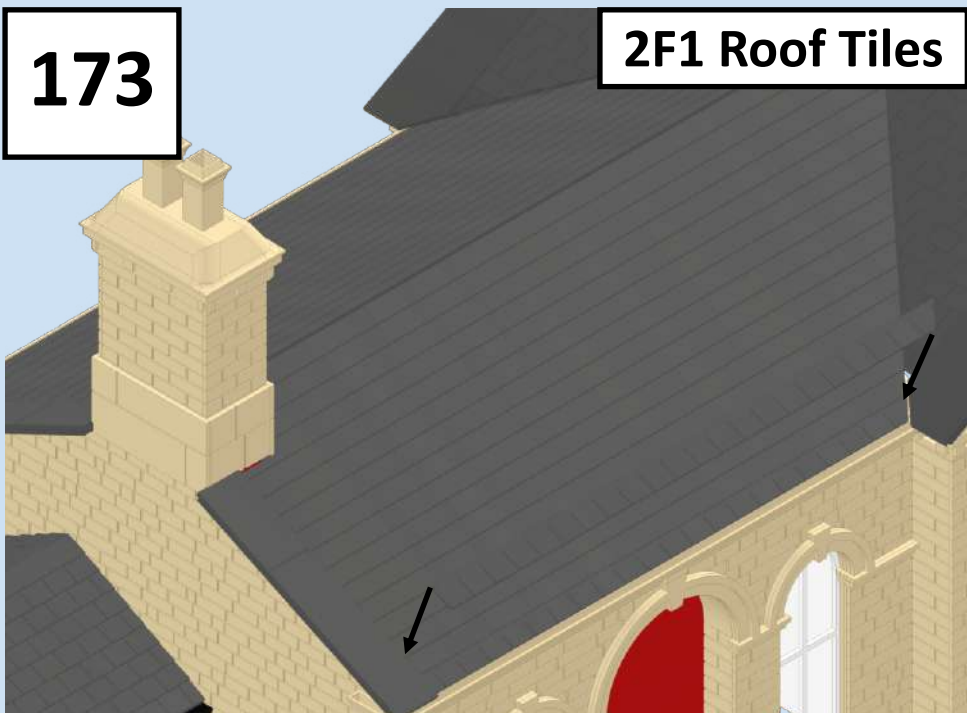

174

2F1 Roof Tiles

Repeat x14

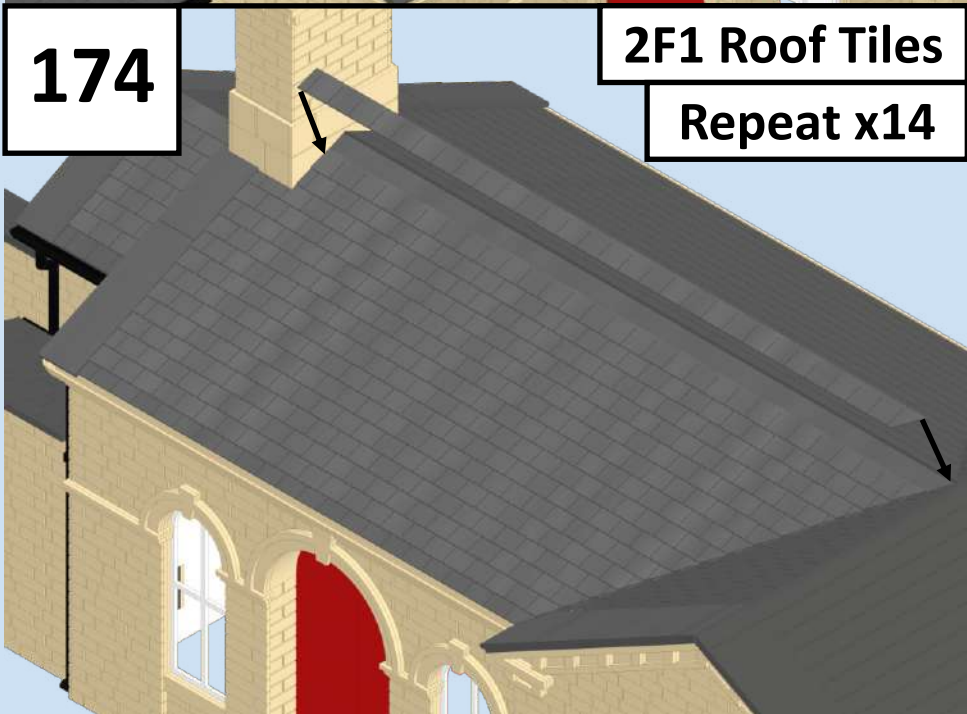

175

2F2 Roof Tiles

Repeat on 2F2



176

1F2 Roof Tiles



177

1F2 Roof Tiles

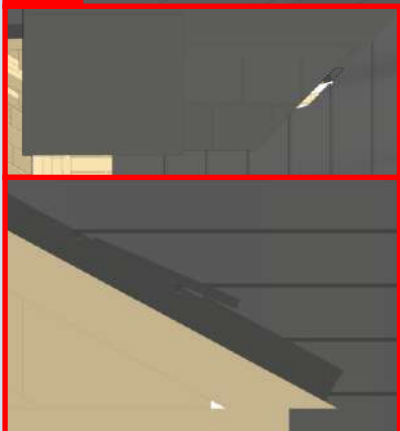

178

1F2 Roof Tiles

Repeat x9

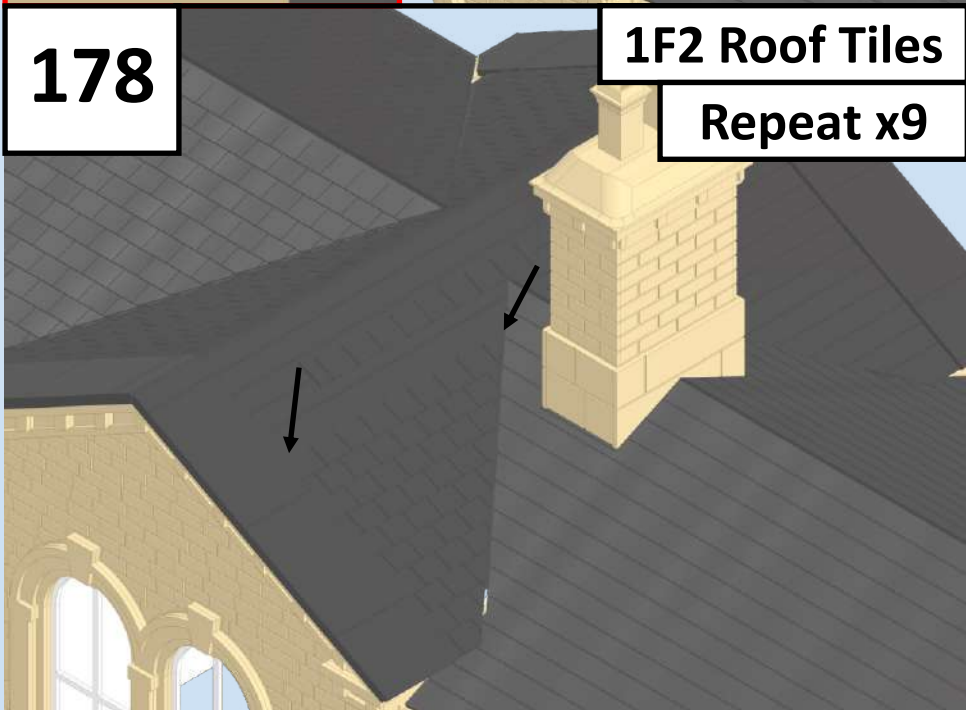

179

1F2 Roof Tiles

Repeat x11

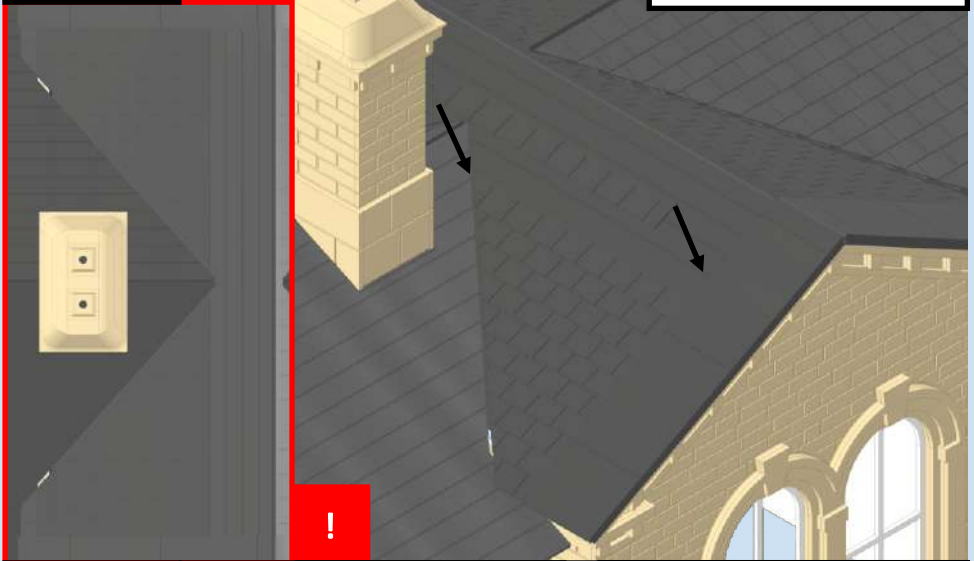

180

1F2 Roof Tiles

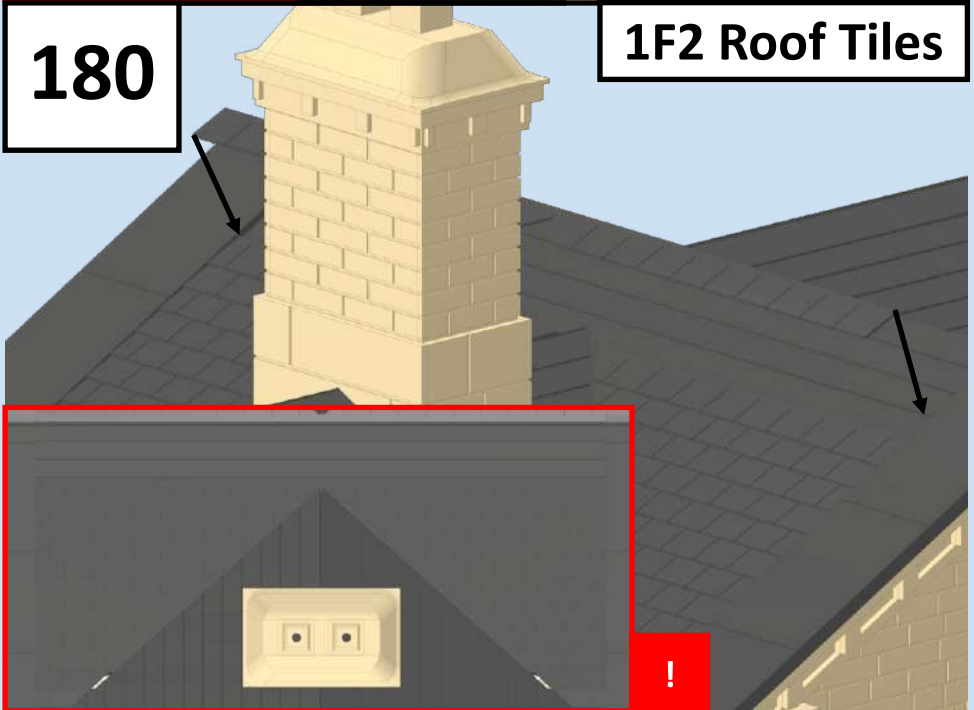

181

1F2 Roof Tiles

Repeat x3

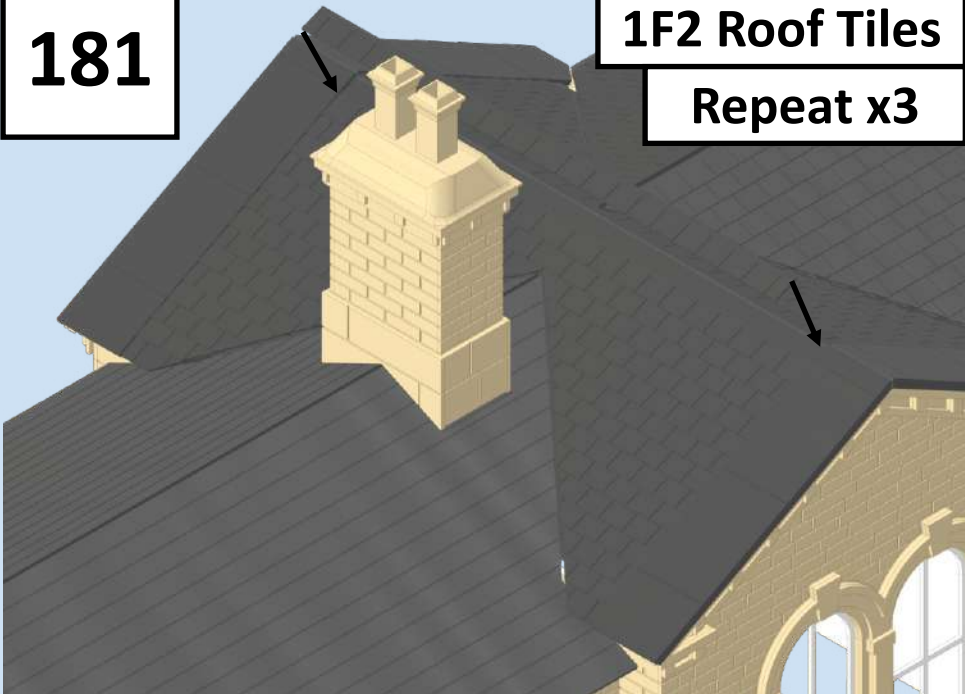

182

1E7, 1E8 & 1E9

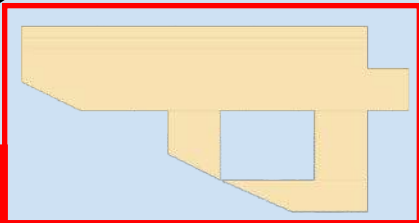
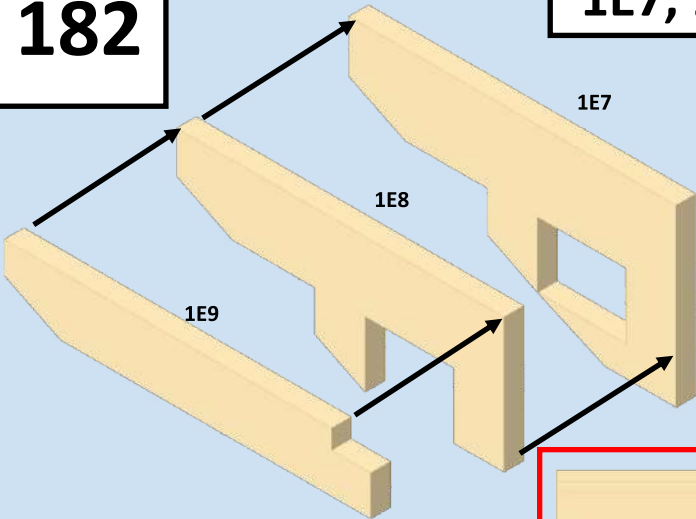

183



184

1E7, 1E8 & 1E9

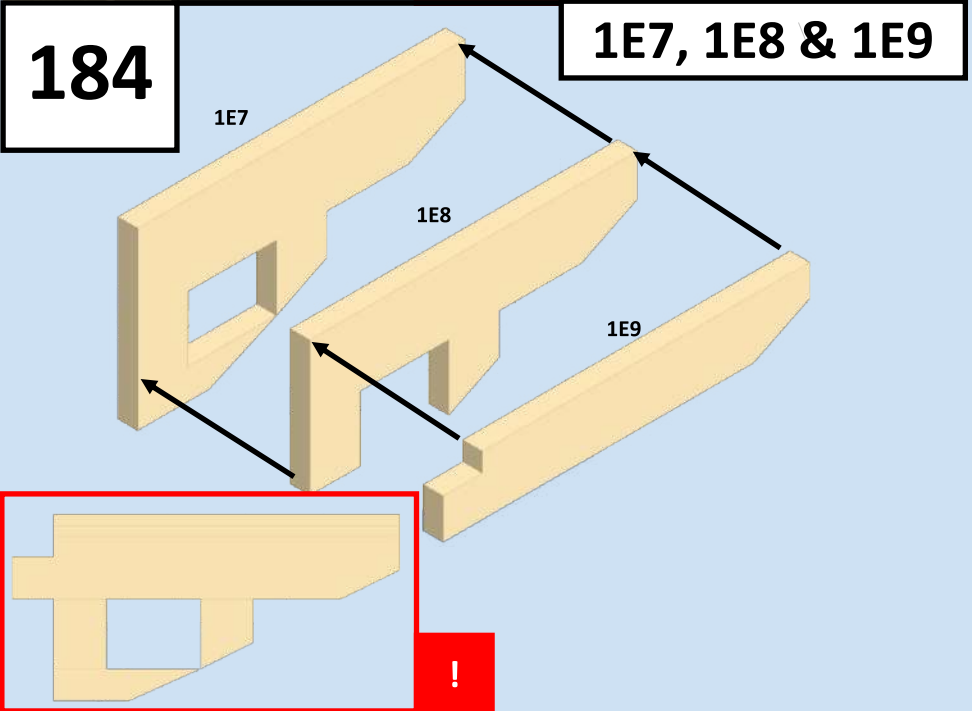

185

!

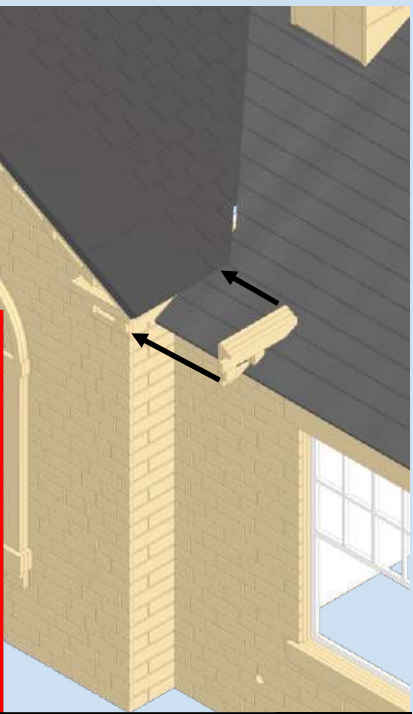

186

B2

B2

!

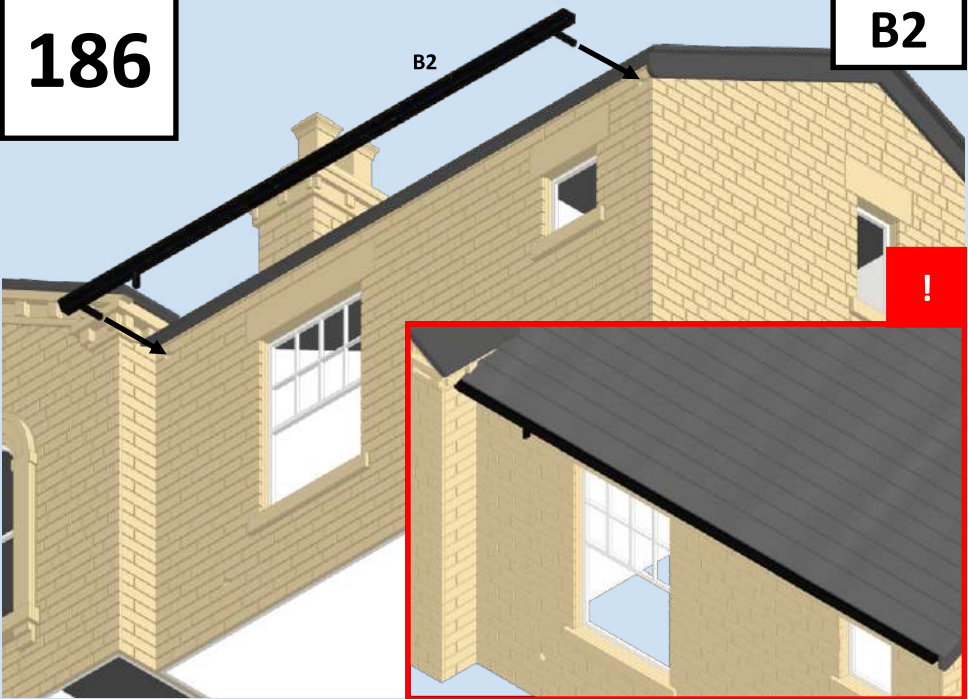

187

B2-5

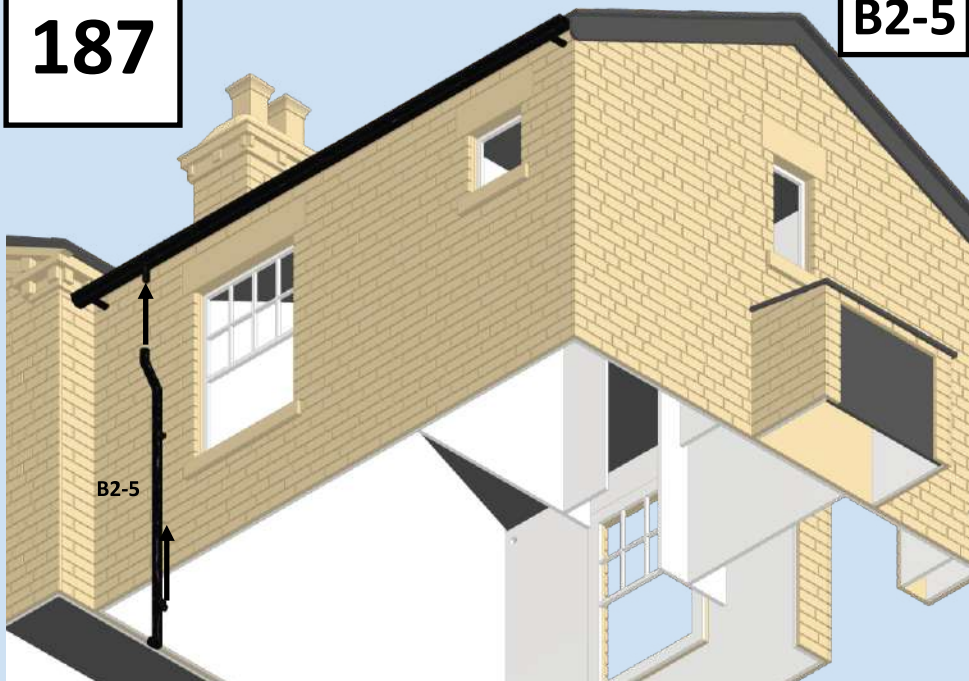

188

B1

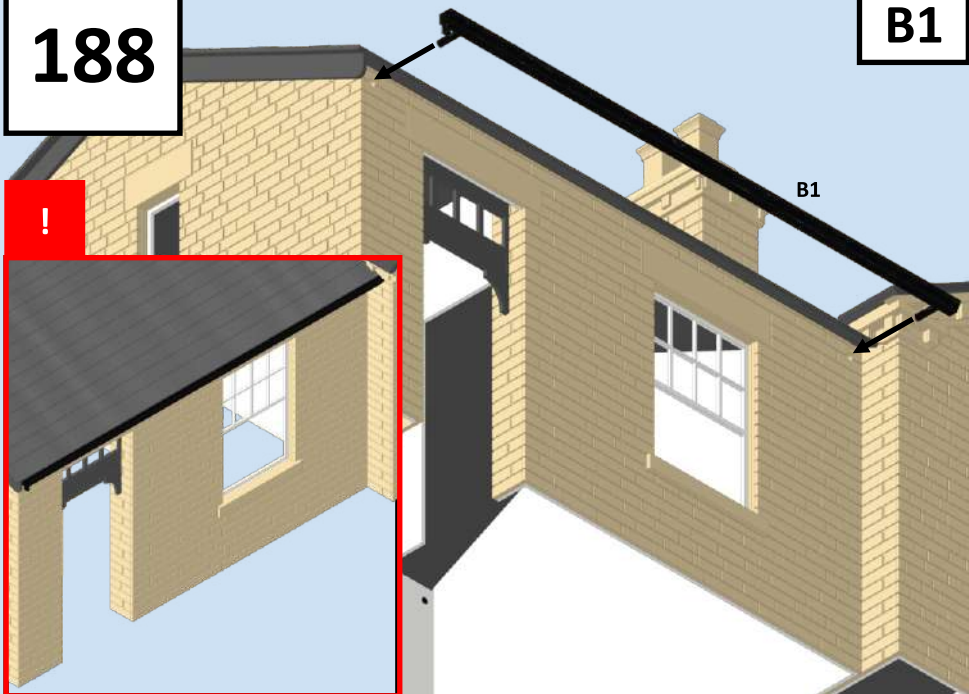

189

B1-5

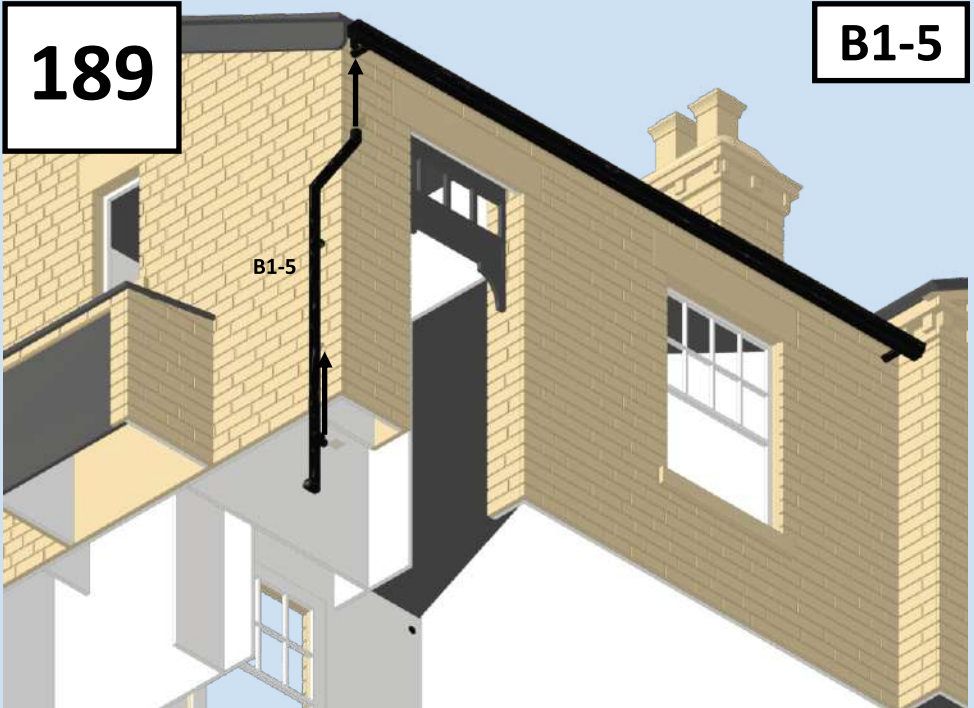

190

3F1 Roof Tiles



191

3F1 Roof Tiles

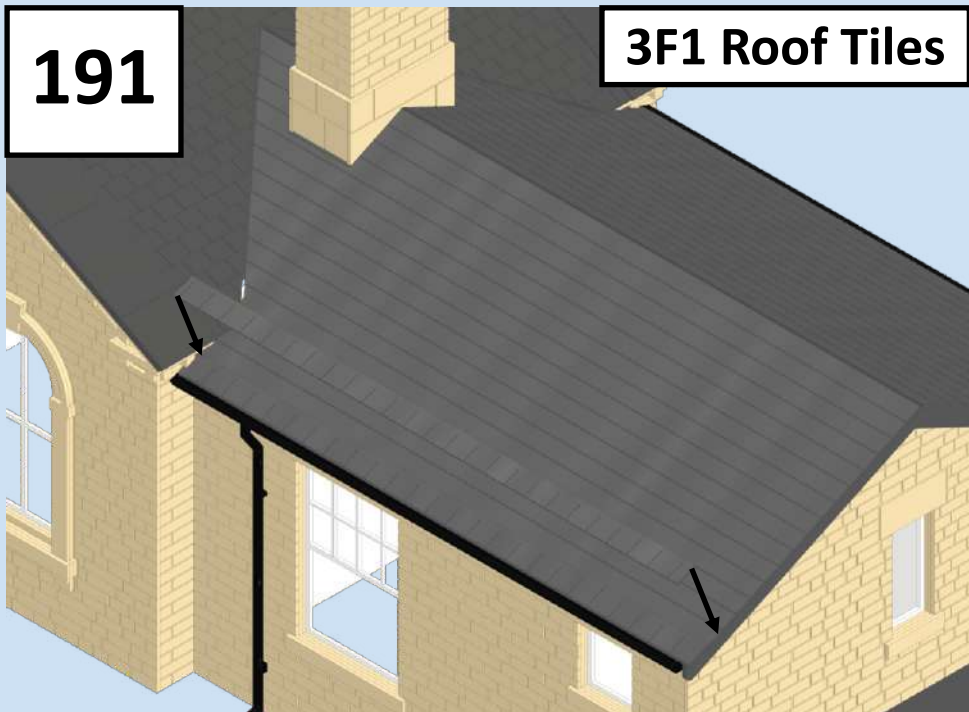

192

3F1 Roof Tiles

Repeat x10

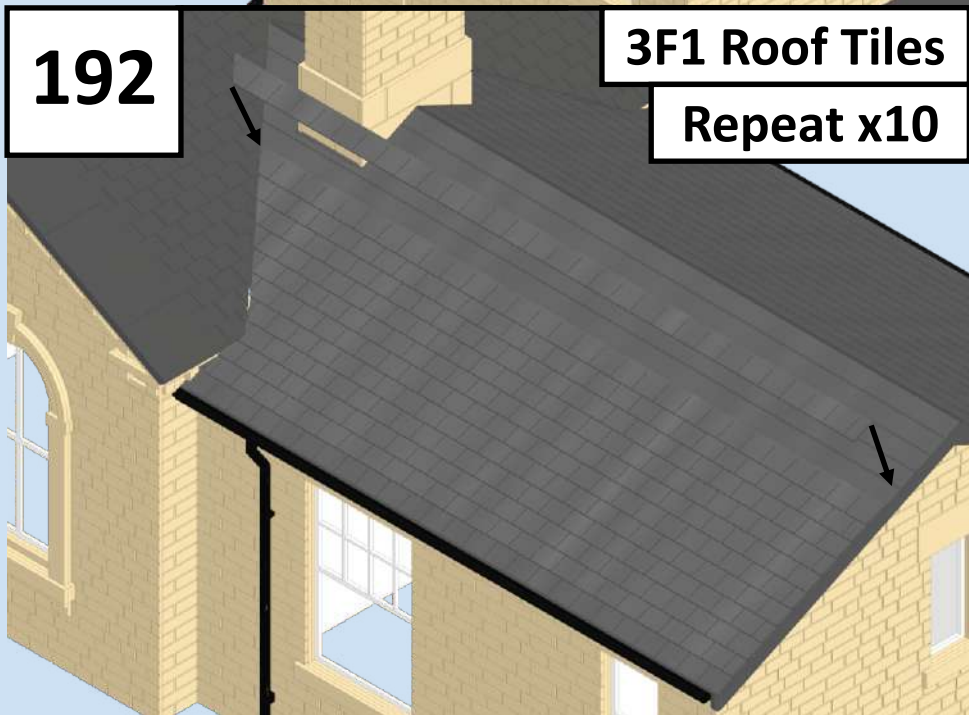

193

3F1 Roof Tiles

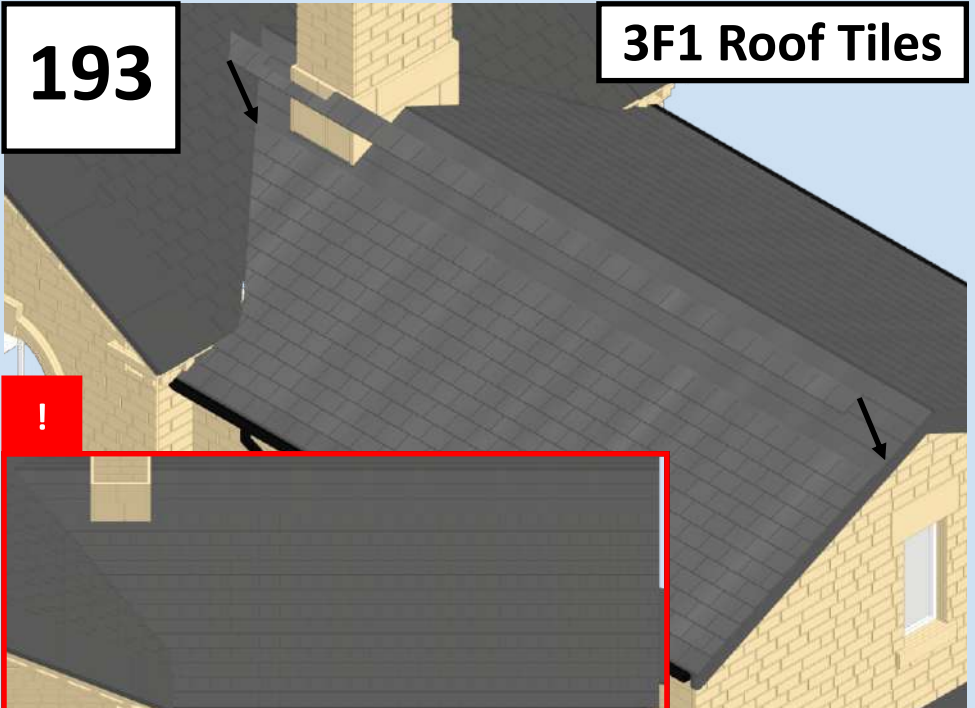

194

3F1 Roof Tiles

Repeat X3

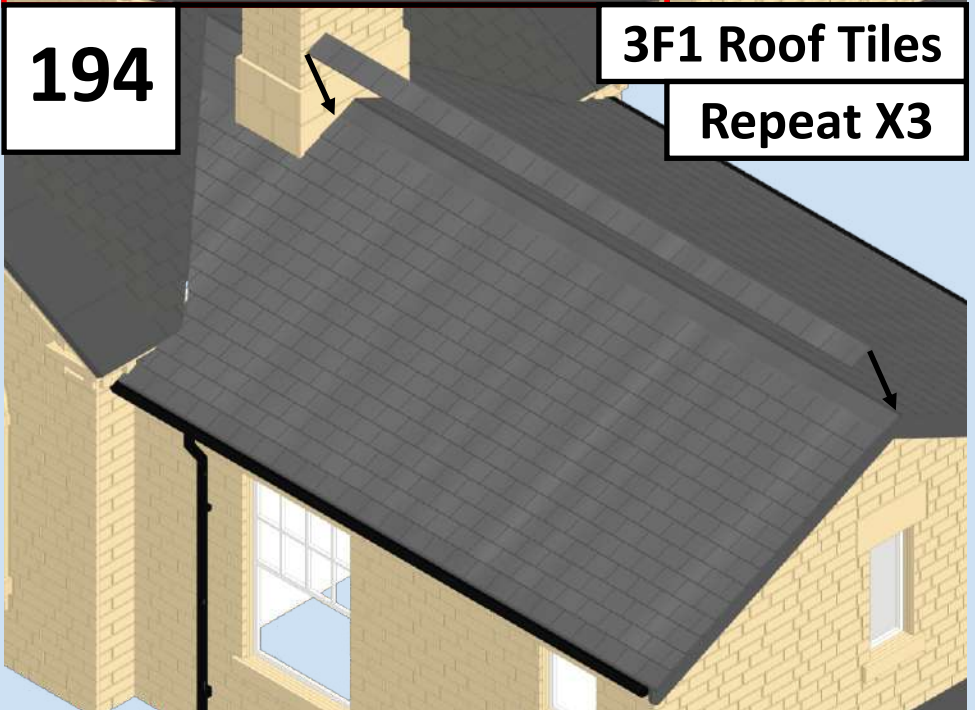

195

3F1 Roof Tiles

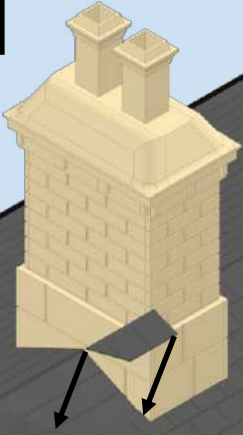

196

3F1 Roof Tiles

Repeat X2

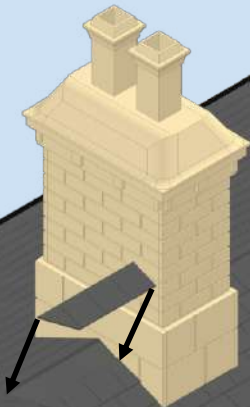

197

3F2 Roof Tiles

Repeat on 3F2

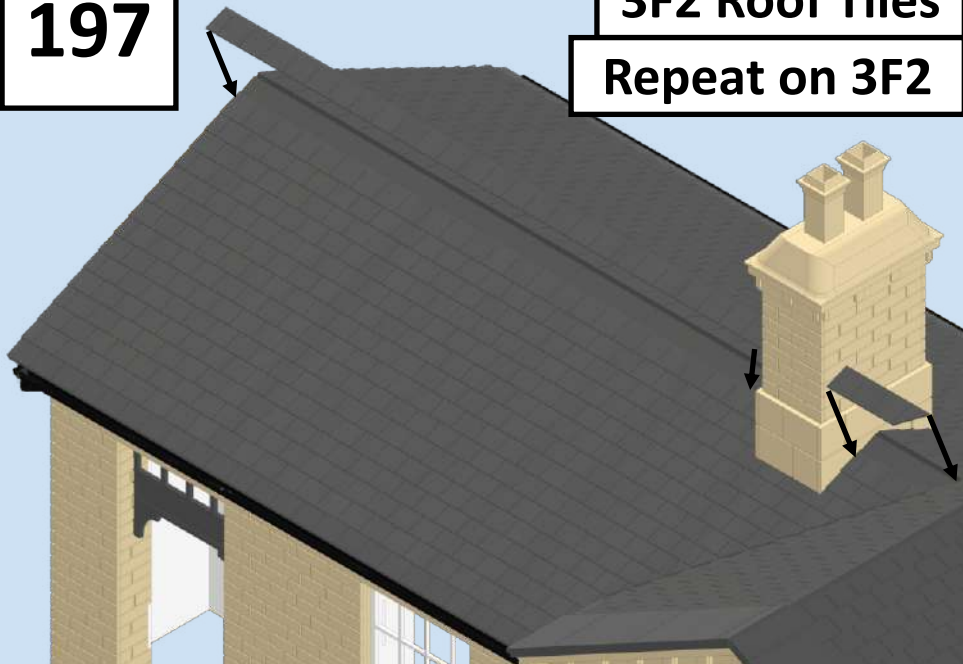

198

Fold Join Covers

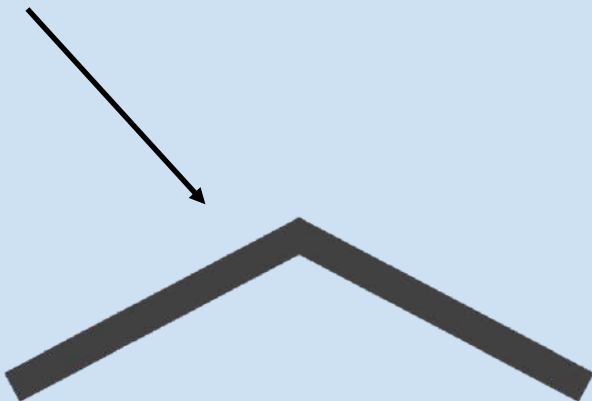
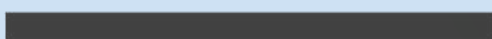

199

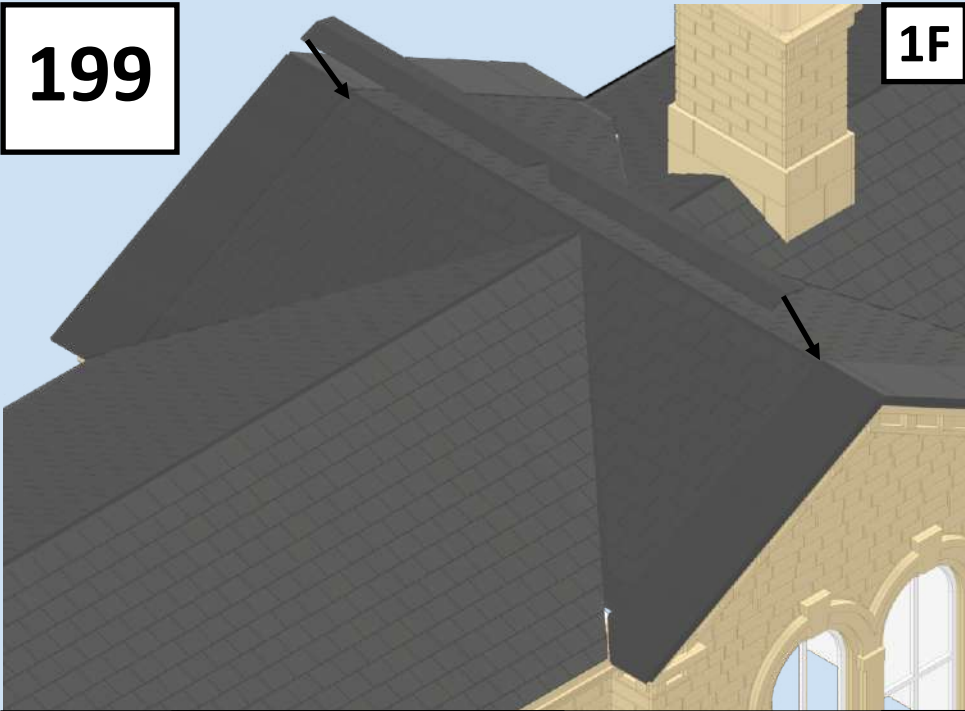

1F

200

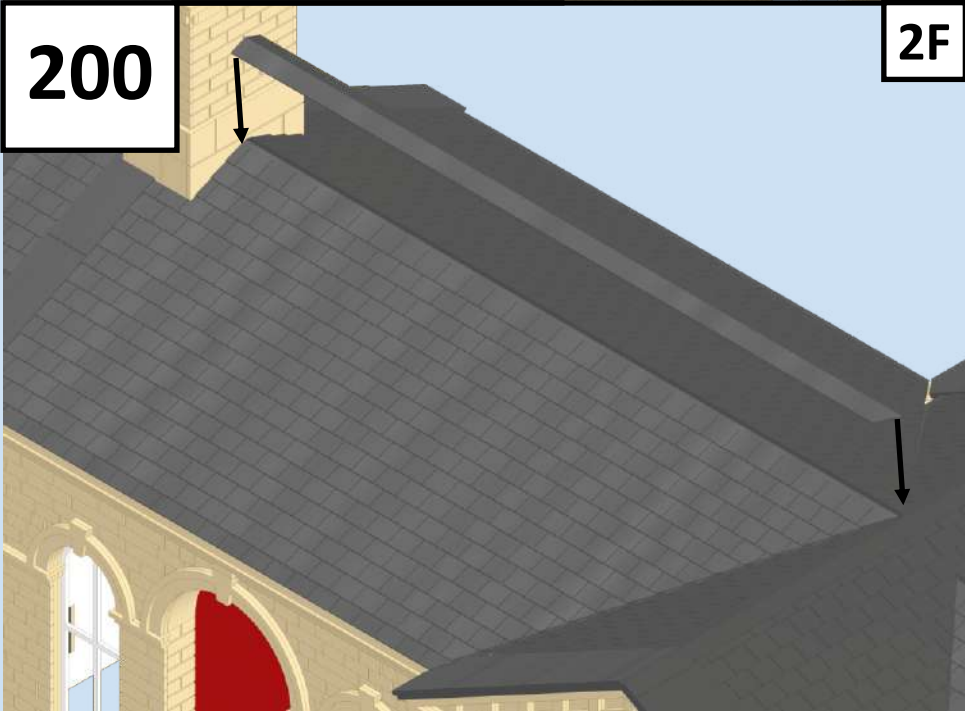

2F

201

3F

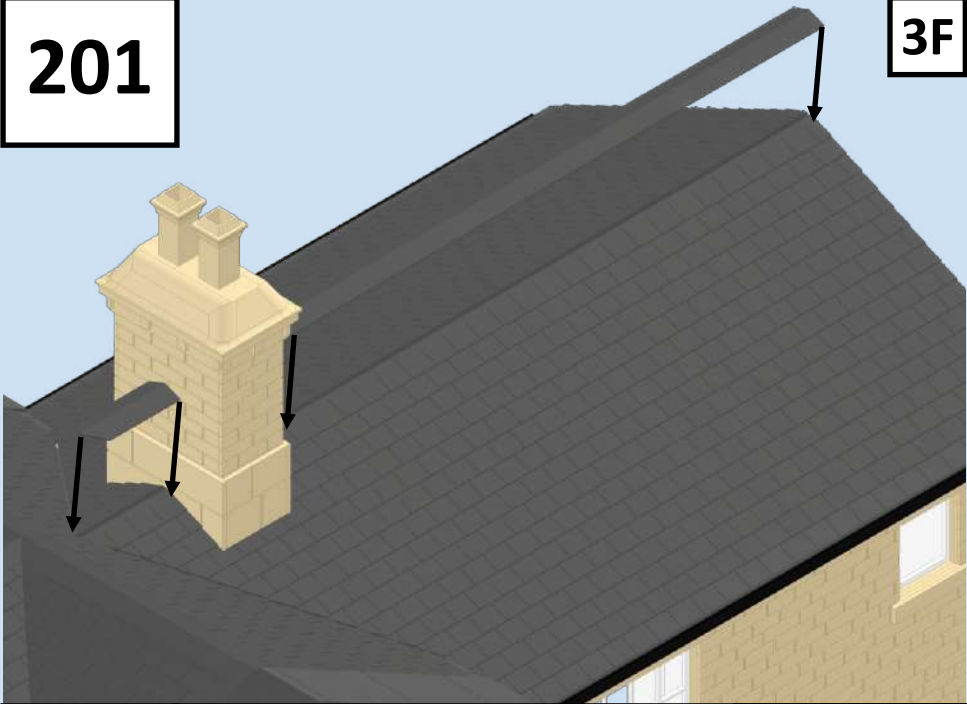

202

1F1 2F1

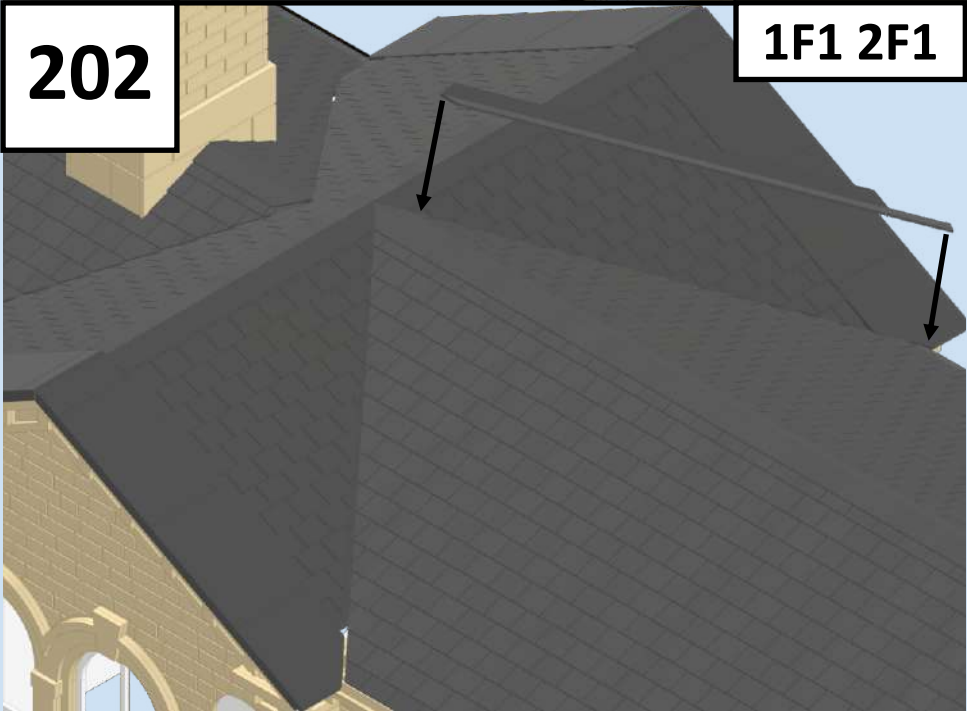

203

1F1 2F2

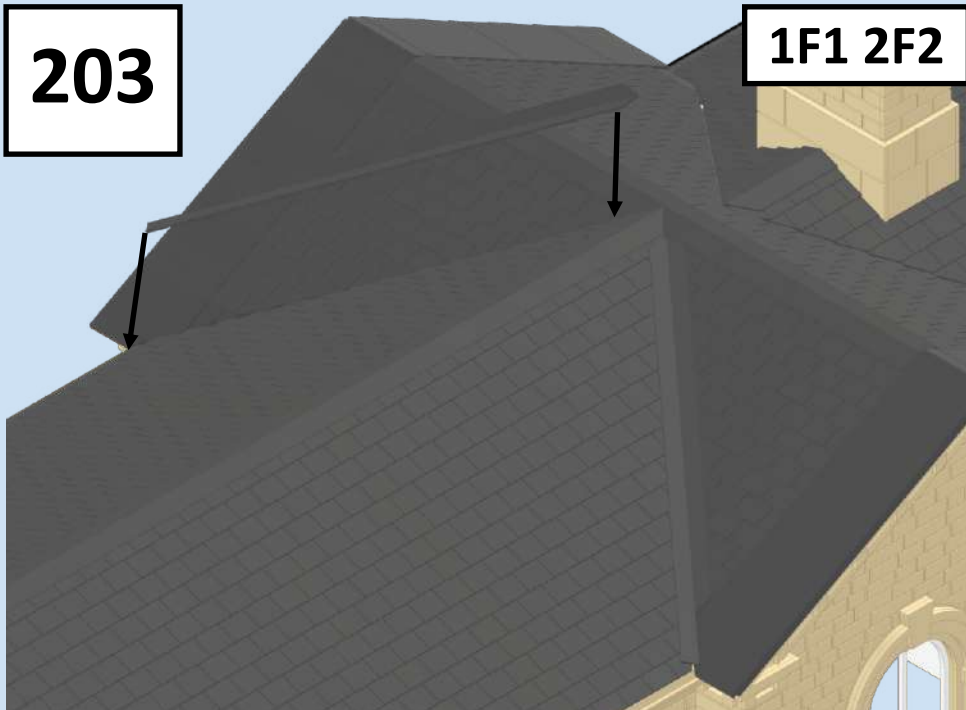

204

1F1 3F1

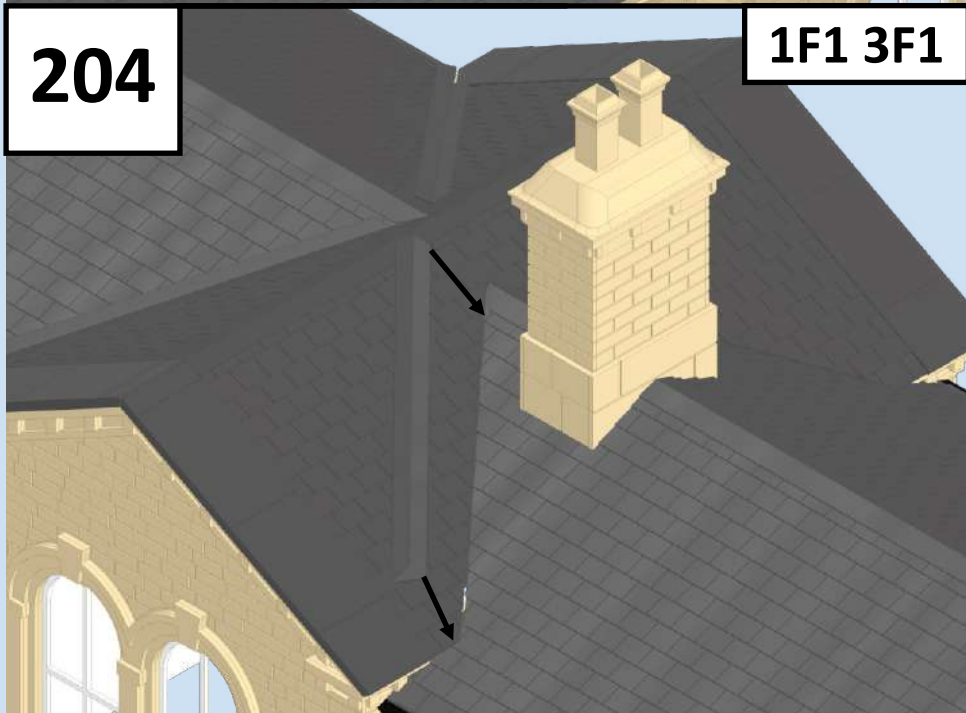

205

1F1 3F2



206

J10 & J11

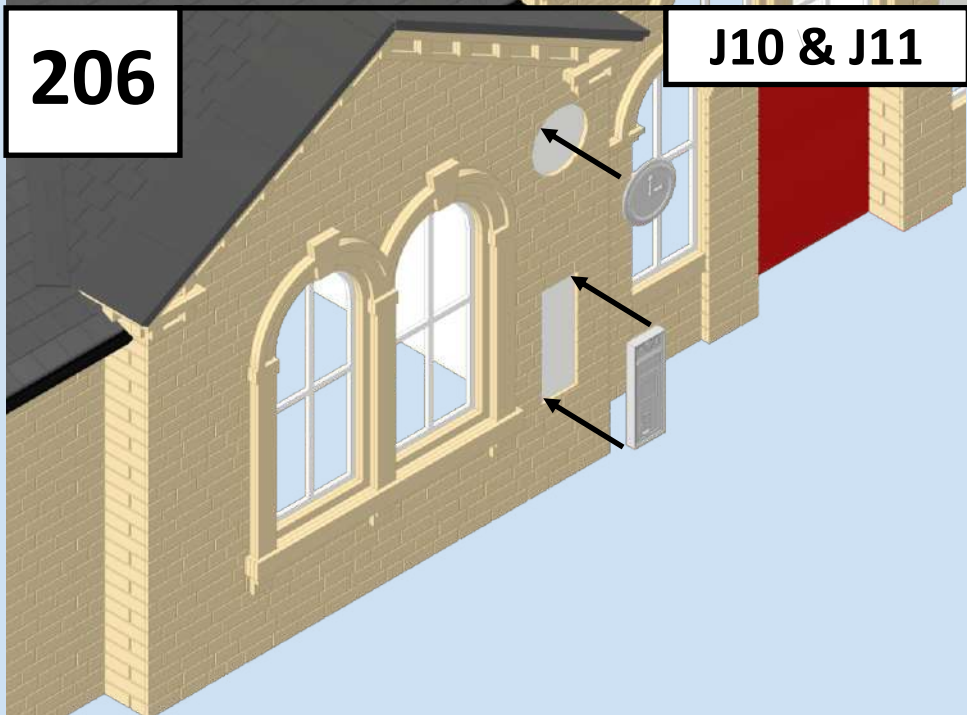

207



The image features the 'dapol' logo in a light grey, lowercase, italicized sans-serif font. The text is enclosed within a thin, light grey rectangular border. The logo is centered on a solid blue background. To the left of the blue area, there is a grey vertical band with a white curved line separating it from the blue field.

dapol