

SECR Wainwright D class
OO Gauge Model

Owner's manual

dapol
Authentic Scale Model

Contents

A short history	4
Specification	5
Quick start	6
Unboxing	6
Running in / First use.....	7
DCC address.....	7
Decoder types (factory fitted)	7
Maintenance	8
Fitting of accessory items	9
Couplings.....	9
Vacuum pipes	10
Guard Irons.....	10
Front coupling.	10
Footplate doors.....	10
Tender Coal Load.....	11
Attaching the tender	11
Installing DCC (DCC Ready models)	12
Speaker installation	13
Fitting the optional tender speaker	14
DCC Factory Fitted models	15
DCC Sound Factory Fitted models	15
Function key summary	15
Brake squeal	17
Chuff intensity:	17
'RealDrive' feature.	18
Contact information:	20
Spare parts	19
Manufacturer's Warranty	26
How to claim	26
Terms and conditions.....	27

SECR D class

Thank you for purchasing this Dapol product.

A short history of the SECR D class

Designed by H. Wainwright at the turn of the century as one of the 3 standard class locomotives for the South East and Chatham Railway.

This elegant example of Edwardian engineering has seen many liveries; from eye catching SECR lined green, wartime Grey, Southern Olive green and latterly BR black in various lining configurations.

The first entered service in 1901 (built by Sharp, Stewart and Company), a further fifty were in service by 1907; 21 built at Ashford works, 10 by German fabricator Dubs & Co. and 5 each: Stephenson & Co. and Vulcan Foundry.

During 1921 and 1927 21 were rebuilt into the D1 class.

Initially operating on the Kent and Hastings services from London the class was primarily stabled in Gillingham by 1930 and allocated to secondary services. Nine Elms saw a number during 1941 and finally Guildford where the last (31075) was withdrawn in 1956.

No. 737 (variously S.R. A737, 1737 and BR 31737) is preserved by the National Railway Museum and is currently displayed at York.

SECR D class

D class model specification:

- Diecast metal chassis and boiler
- Diecast wheels, motion and connecting rods
- 2nd radius ability
- Sprung buffers
- Pickup from Loco. driving and tender wheels
- Brass bearings
- DCC Ready (Next-18)
- 'Toolless' DCC decoder and speaker fitting
- Optional speaker in tender (standard with factory-fitted sound)
- Compact, push-fit electrical tender drawbar
- Close coupled tender
- Close coupling arrangement for tender to train coupling
- Highly detailed body and cab interior
- Firebox flicker effect

The model is available in many versions reflecting changes made during the working life of the prototype.

- 4 or 5 band boilers
- Riveted and smooth smokeboxes
- Two chimney types
- Round and rectangular cab windows
- Studded and un-studded wheels
- Unfitted and vacuum fitted
- Other external detail variations



This manual applies to all versions of Dapol's Wainwright D class model

SECR D class

Please read this section before you go any further!

Quick start: *We know you would like to have your model running as quickly as possible; please spare a moment to read this green section first.*

An accessory pack is supplied containing:

- A coupling and NEM socket
- PCB / Smokebox door tool
- Vacuum pipes
- 1 pair guard irons
- 1 pair footplate doors

• Vacuum pipes are supplied with all models but are only intended for use with certain variations.

Models fitted with optional DCC or DCC sound will operate on DC or DCC (When operating on DC, sound fitted models will produce exhaust sounds automatically.)

Icons used in this booklet:

 **Information:** Hints and tips

 **Caution:** Take care when performing this step

 **Warning:** A risk of damage may exist

 The model is packed in a two-part blister pack. Please unpack as below. *Please re-pack in the same way before sending for warranty or service*

Unboxing:

Remove the model whilst in its clear packaging from the foam insert. (The accessory pack will be found between the outer and inner parts).

SECR D class

Slide the outer clear shell from the inner clamshell.

Lift the clamshell 'latch' (top right of package with respect to the locomotives left side).

Carefully lift the locomotive and tender separately from the packaging.

The tender must be separated from the locomotive before re-packaging.

Operation

Running in / First use: No special running in or initial lubrication is required; Dapol 'new generation' locomotives have been designed with care to offer many years of service with minimal maintenance.

i Before operating your model, first run in both directions at a low speed checking for correct operation using either DC or DCC.

i A Non-DCC fitted model will not operate on a DCC controlled layout.

i The **DCC address** is factory set to address #3.

i **The decoder fitted** is a Zimo MX658N18 (DCC sound) or Dapol Imperium (DCC) dependent on version.

SECR D class

If operating a DCC fitted model on DC, please follow the DC operating procedure. Further information is available in the relevant sections.

i A DCC fitted model will 'autodetect' and operate on both analogue (DC) and DCC

Maintenance

We have designed the model using components which require little maintenance. We suggest that if preferred the drive train and gear box are lubricated after every 100 hours running using a single drop of light synthetic lubricating oil such as Dapoil or Locolube™. This will migrate through the drive train during running.

Lubrication can be optionally applied to axle bearings and connecting rods without removing covers.

To lubricate the worm gear, unclip the brake rodding and remove the 4 keeper plate screws.

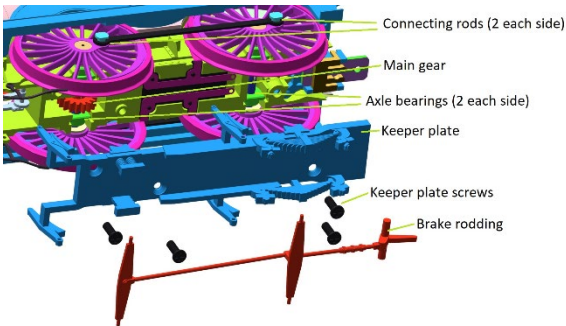

Check the pony truck slides to ensure that no build-up of debris is apparent. If found to be dry, then a little light grease can be used between the chassis and the washer.

SECR D class



Fitting of accessory items

Couplings: The model is fitted with one hook and loop style coupling to the tender and a second in the accessory pack. The Tender is fitted with an NEM coupling box, permitting easy exchange for any compatible NEM style coupling.

The pony truck is fitted with a removable front panel. This can be replaced with the coupling and NEM pocket from the accessory pack.

 **Warning:** Mineral oil types or thicker oils may damage your locomotive paint finish or components and invalidate your warranty.

 **Caution:** Do not over oil. Over oiling may damage paint finishes and/or cause build-up of dust.

-  Remove any surplus or spilt oil immediately using a lint free cloth.
-  Regularly check your model for build-up of dust of loose scenic material around moving parts.

SECR D class

Vacuum pipes: Are supplied with all models and are intended for fitting to models of vacuum fitted locomotives

(identified by the fitting point to the left of the coupling hooks on loco and tender. The section of pipe supplied is intended to be fitted under the buffer beam as shown (a fitting point is located in the chassis).

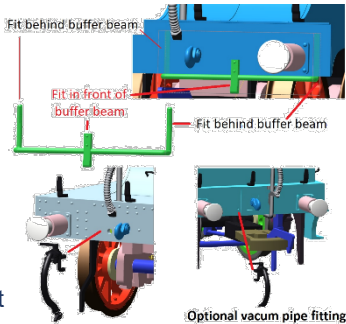

Guard Irons: Are optionally fitted to the front of the model, under the buffer beam. (Whilst fitting ensure they are vertical and do not foul the front pony wheels)

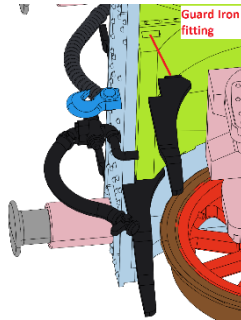

Front coupling: A crossmember is fitted to the front of the pony truck by means of a dovetail. This can be exchanged with the coupling and NEM pocket provided in the accessory pack.

Footplate doors: Two doors are provided which clip into position behind the cab storage lockers.

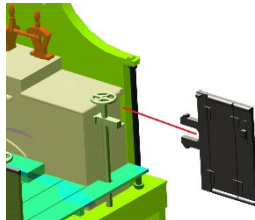

SECR D class

Tender Coal Load: The tender coal load is removable and simply lifts out.

i A detailed representation of the coal hopper profile will be found beneath, allowing you to custom fill the tender to the level you require with the material of your choice.

i Use of the smokebox door tool will assist removal of the coal load without marking the finish. We suggest lifting from the rear of the load.

All other accessories are factory fitted to the model.

Attaching the tender

Place the locomotive and tender on a straight section of unpowered track, with the drawbar halves facing each other.

Gently push the tender to the locomotive, whilst steadying the loco with your other hand.

The drawbar coupling will self-locate and a soft 'click' will be heard when it is connected.

⚠ Caution: If the tender requires any more than a little force to connect then stop and check the couplings are facing each other and that there is no obstruction or damage.

Installing DCC (DCC Ready models)

Dapol recommend using a Dapol Imperium 18 pin decoder.

The decoder chosen must offer a minimum of 1 accessory function to operate the firebox flicker.

This model is fitted with Dapol's tool-less DCC and speaker fitting system. To install a decoder and/or optional speaker follow these steps:



Remove the smokebox door. This is a friction fit, (carefully use the wedge end of the smokebox door tool under the hinge if required.)

i The smokebox door tool is made from soft plastic, which avoids scratching the paint finish.

Using the 'hook' end of the smokebox tool to engage with the hole in the PCB (highlighted white on the

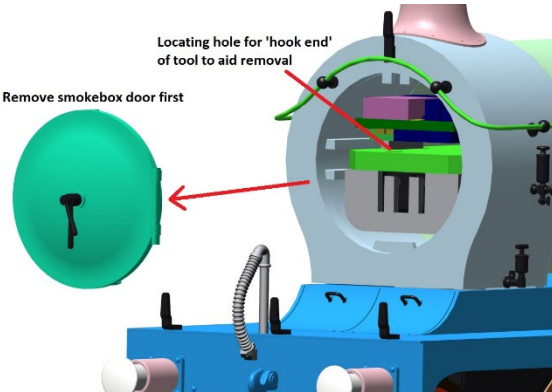

PCB), pull out the decoder PCB.

When the PCB is fully removed from the smokebox the decoder blanking plate can be removed in the usual way.

SECR D class

Speaker installation

Warning: Incorrect speaker selection may result in damage to the decoder.

If using a sound decoder an 8-ohm 'Sugar cube' type speaker should be installed (DCC Supplies Product Code: 112965). If it is intended to fit a 2nd speaker in the tender it must be correctly matched with the speaker fitted in the smokebox to produce a total impedance suitable for your decoder's amplifier.

The speaker enclosure is removed by unclipping (it is held by 2 clips).

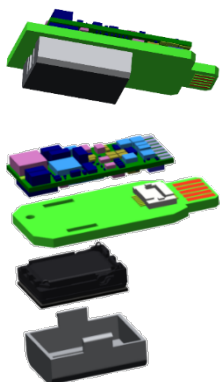

After fitting a sealing gasket, drop the sugar-cube speaker into place with the contacts uppermost and facing the rear of the PCB. Clip the speaker enclosure back in place on the PCB.

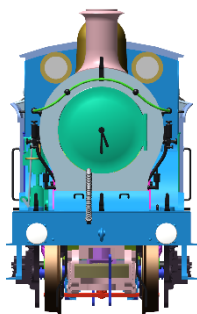

Slide the PCB into the locomotive, with the speaker on the lower side.

Finally, refit the smokebox door with the hinge on the left side of the model.

Optional tender speaker

If required, an optional 8-ohm bass enhanced speaker can be fitted into the tender (DCC Supplies part No: 100790)

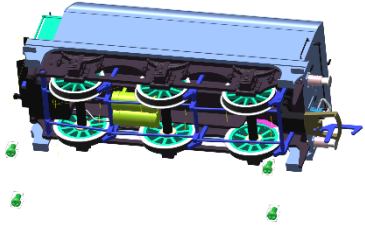

Using a Phillips 00 screwdriver, remove the four cross head tender top retaining screws.

i If preferred, the brake rodding can be unclipped from the brake hangers first to improve access to the screws

i Refer to the warning on page 13 and check your chosen decoders manual to carefully select the additional speaker. The speakers are wired in parallel. *For example: Using 2 x 8-ohm speakers will produce a decoder load of 4 ohms.*

Solder the speaker leads to the PCB pads located on the tender chassis.

The speaker is fitted into the cast recess using the locating lugs moulded onto the speaker.

Re-assemble the tender top. The speaker will operate automatically without any further configuration.

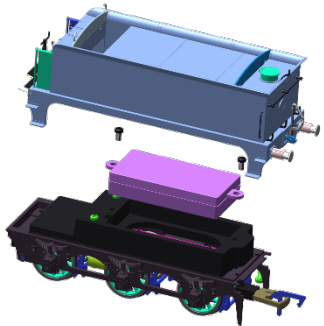

SECR D class

DCC Factory Fitted models

Are fitted with an imperium DCC decoder (address 3) to control the locomotive. The following function keys on your controller operates special functions.

F1	Firebox flicker On/ Off
----	-------------------------

DCC Sound Factory Fitted models

This model is pre-fitted with a Zimo sound decoder, sugar cube speaker in the smokebox and bass enhanced speaker in the tender. Authentic sounds from an operating locomotive have been recorded as both manual and automatic sounds. Manual sounds are operated by the following keys on your DCC controller.

- i** When operating your locomotive on a DC (analogue) layout the decoder will autodetect the power source and produce a synchronised exhaust sound.

Function key summary:

F1 Sound fade in/out: Useful when loco is going 'on or off scene' or into / out of a tunnel.

F2 Short whistle

F3 Long and short whistle

F4 Coal shovelling: The sound of the firebox door being opened, followed by the firebox flicker effect operating. During this time the sound of shovelling coal will be heard. When F4 is turned off, the shovelling will stop and the firebox door will be heard to close, at the same time as the flicker extinguishes.

SECR D class

- F5 Injector on/off:** The injector is used when topping up the water level of the boiler.
- F6 Steam ejector on/off:** Used for creation of a vacuum and for blastpipe draft creation.
- F7 Brake application/release:** When first pressed the sound of a brake application will be heard, when pressed again (turned off) the sound of the brakes being released will be heard.
- F8 Flange squeal on/off** If the locomotive is moving at low speed with 'light engine' activated (F9 ON), a rail 'crump' sound will be heard. At low speed with 'light engine' deactivated (F9 OFF), the flange squeal of a train will be heard. Higher speeds produce a higher pitched squeal (regardless of the setting of 'light engine' - F9).
- F9 Light engine mode:** with F9 ON lighter chuffs will be heard and the locomotive will accelerate and decelerate more readily. CV390 can be adjusted to change this 'inertia' effect. A factory value of 140 is set for this.
- F10 Safety valve 'blow off'**
- F11 'More steam' sequence:** Injector sound with coal shovelling sound.
- F12 Manual draincocks:** Additional to the automatic draincocks. Enables the sound of steam 'blast' from the cylinder drains to be triggered.
- F13 Buffering up:** If F13 is turned ON whilst the locomotive is moving, it will 'preselect' the buffer crash which will be heard when

SECR D class

locomotive halts. If F13 is turned OFF whilst stationary, the sound of coupling up is heard. If F13 is turned OFF whilst the locomotive is moving, no sound will be heard.

F14 Coach door slamming on/off

The door slam sound will continue until F14 is turned off.

F15 Guards whistle

Automatic sounds

Brake squeal: This sound will be produced when the locomotive speed drops below a pre-set value, only whilst the locomotive is decelerating. The threshold value can be set using CV 287 and can be increased or decreased from the factory value of 20.

Chuff intensity:

The locomotive can produce 3 intensities of exhaust 'chuff'. Heavy chuffs will be heard whilst accelerating, lighter ones when the target speed is reached. Upon deceleration, no chuffs will be heard.

With F9 ON, even lighter chuffs will be produced, with more 'cut-off'.

‘Realdrive’

A basic driving function is enabled by default. An advanced operation (‘Realdrive’) is possible which adds coasting and a working brake. This allows operation in a more prototypical manner. Brake applications will be needed to bring the model to a stop – closing the throttle results in the model coasting.

These two features are added to the ‘light engine’ feature that remains active with or without the ‘RealDrive’ feature.

i If you are new to ‘RealDrive’ Dapol recommend testing on a clear track, preferably a loop.

To activate ‘RealDrive’ set CV4 to 254, and CV309 to 7.

To de-activate ‘RealDrive’ set CV4 to 27 and CV309 to 0. (These are the factory settings)

Driving technique: As the regulator is closed (speed step 0) the model will continue to coast for a considerable distance, slowing gradually. Applying the brake using F7 will bring the locomotive to a stop. The braking rate can be adjusted by changing CV 349 (High values lessen the braking effect).

Points to consider:

When F7 is ON the brake is ON. When F7 is OFF, the brake is OFF.

i Set F7 on your DCC system to ‘momentary’ to make a brake application with a single press.

The regulator must be closed for the brake to take effect.

SECR D class

Braking intensity is altered via CV349. (factory setting is 27)

Sharper brakes (low values in CV349), allow multiple short applications.

A gentle brake (higher values in CV349) will allow a single application of the brake to bring the model to a halt.

i Whilst the brake (F7) is ON, the model will not accelerate. If stationary and the regulator is opened with the brake ON, the model will not move.

i To simulate heavier chuffs (e.g. whilst the model is climbing), put the brake(F7) 'ON' and open the regulator by at least one speed step. This will initiate heavier chuffs until the regulator is reduced OR the brake is turned off.

i To use the regulator only to bring the model to a halt, the brake is turned on first and the speed reduced as required. Speed will then reduce at the pre-set braking rate.

i To operate a consist using 'RealDrive' and avoid difficulties, all locomotives consisted must have 'RealDrive' activated. Equally all models must have 'Realdrive' deactivated if not

Contact information:

Dapol Customer service:

Telephone: 01691 774455

Email: sales@dapol.co.uk

Website: www.dapol.co.uk

Service and Spares:

DCC Supplies Ltd.

Telephone: 01905 621999

Email: dapol@dccsupplies.com

Website: dapolspares.dccsupplies.com

Spare parts:











When ordering parts, please ensure you quote Dapol's part number and the model's running number/livery, as parts and colours will vary between versions.

Additional parts to those illustrated may be available, please check dapolspares.dccsupplies.com for full list.

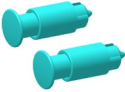









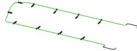



Certain parts are common to other models and will share the same part number.











SECR D class



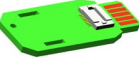







Part Number	Part image	Description
For: LOCOMOTIVE		
115717		Chimney 1
115718		Chimney 2
115719		Whistle
115720		Safety valve
115721		Buffers (Pair) (Loco & Tender)
115722		Buffer beam set
115723		Lamp bracket set (Loco) Version dependent
115724		Front pony frame Assembly
115725		Lubricator set
115726		Steam reverser assembly
115727		Smokebox door (Plain)

SECR D class

Part Number	Part image	Description
For: LOCOMOTIVE		
115728		Smokebox door (number board)
115729		Handrail set (loco)
115730		Connecting rods
115731		Connecting rod bolt set
115732		Front pony axle set (Studded)
115733		Front driving wheel set (Studded)
115734		Rear Driving wheel set (Studded)
115735		Front pony axle set (Plain)
115736		Front driving wheel set (plain)
115737		Rear Driving wheel set (Plain)
115738		Axle stub covers
115739		Locomotive brake rod
115740		Locomotive "keeper" plate

SECR D class

Part Number	Part image	Description
For: LOCOMOTIVE		
115741		Body & keeper plate screws (set)
115742		Cab (footplate) Doors
Part Number	Part image	Description
For: LOCOMOTIVE(electrical items)		
115071		Motor, worm & flywheel assy
115743		Motor mounting set
115073		Loco "motherboard PCB" & mounting
115074	<No Image>	OO "Pullout" PCB DC blanking plate
115075		OO "Pullout" PCB
115076		OO "Pullout" PCB speaker housing
115744		Loco pickups (Pair)
115745		Gearbox cover and screws (Set)
115746		Gear set
115080		Electrical drawbar (Locomotive) set

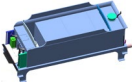
Part Number	Part image	Description
For: TENDER		
115747		Wheelset Studded (Single Axle)
115748		Wheelset Plain (Single Axle)
115749		Tender lamp iron set
115750		Tender footplate detail set
115751		Coal load
115752		Tender buffer beam set
Part Number	Part image	Description
For: TENDER (Electrical items)		
115753		Pickups
115090		Electrical drawbar (Tender) set
115754		Tender coupling (train) assembly
Part Number	Part image	Description
Assembled and decorated items		
115755		Loco Body shell (Complete state part number)
115756		Tender Body and chassis (Complete, state part number)

Warranty

Manufacturer's warranty

We want you to be completely satisfied with your purchase and obtain many years of pleasure from its operation. If you experience any problems with your model, we suggest that your first point of contact is your retailer; they will be able to advise on any teething problems and will use their experience to quickly solve many of your questions or concerns.

The place of purchase is also the fastest way to exchange a model which is found to be missing components, accessories, or is otherwise defective after purchase.

But we recognise that you may require more: If a replacement model is not available you may find a refund disappointing, or you may simply prefer to deal directly with Dapol. For these reasons, we offer a 12-month manufacturer's repair warranty on this product in addition to your statutory rights.

i Our Manufacturer's warranty in simple terms:
If your model experiences a mechanical or electrical fault within one year of purchase, other than returning to the place of purchase, we offer you have the option of a free repair at our service agents which is (within the UK) also post free.

2nd year service (locomotives only). An option exists to have your locomotive serviced by our authorised agent (a service fee is payable). Simply contact our agent and you will be advised of the current cost and given a freepost address. The model will be serviced and returned with a validated warranty certificate for a second year of no-quibble warranty for your model.

i Please note: Year 2 warranties cannot be issued more than 13 months after the original date of purchase.

Warranty

 **VERY IMPORTANT:** Please ensure that the place of purchase has supplied a proper printed receipt with your purchase. Without this, our service agents are unable to offer warranty service. Repairs will be charged at the prevailing rate. Your statutory rights with the place of purchase are unaffected.

How to claim:

- Locate the proof of purchase (copies acceptable)
- Year 2 claims: Return with validated 2nd year certificate (or service fee if within 13 months of purchase).
- Contact our service agent for a Job ID number.
- Write the Job ID number on the outside of the package, and enclose your name, contact information, proof of purchase and if applicable your year 2 certificate.
- When posting, ensure that you obtain proof of posting and the model is adequately packed. If you require proof of delivery or insurance, you will need to purchase the additional service (at your cost) from your post office.

What happens next? If you have supplied an email address, receipt will be acknowledged, you will be advised when work commences and is completed. They will contact you in case of unforeseen difficulties during repair.

Using your email address, you can use the online enquiry system to check the status of your model at any time via your web browser at

helpdesk.dccsupplies.com

Warranty

If you have not supplied an email address, your model will be repaired and returned, you will only be contacted in case of a problem. You may of course contact our agent (quoting the job ID) at any time.

What happens when the warranty expires? Our service agent offers a comprehensive repair service at reasonable cost. Alternatively, a comprehensive range of spare parts is available for purchase.

The small print! (Terms and conditions) We intend this 'No Quibble' warranty to be a simple and fair addition to your statutory rights, however, some situations simply cannot be covered as they are outside of our control. We've listed these below.

 We're reasonable folks, so if in doubt, please contact either our customer service or our service agents who will advise on your situation and suggest the best course of action.

Terms and conditions:

1. Only Dapol models packaged with this warranty or marked with a 'W' are covered under this scheme.
2. This manufacturer's warranty is in addition to your existing statutory rights and offers a repair service for your model. Requests for outright refund or replacement should be directed to the place of purchase.
3. In the event the model cannot be repaired, at Dapol's sole option, you may be offered: a new replacement model (subject to availability), a refund voucher (for exchange at the place of purchase) or the return of the model in an unrepaired condition.
4. On issuance of a replacement model or refund voucher the original model and all associated accessories shall become the property of Dapol Ltd.

Warranty

5. The replacement or repair of a model shall not extend the original warranty period under any circumstance.
6. This warranty covers the model's electronics, chassis and mechanisms for manufacturing defect or premature failure. The following situations shall invalidate this warranty:
 - a. Accidental damage
 - b. Missing accessories (i.e. accessory packs) – (Please return to the place of purchase at the time of purchase).
 - c. Over or under oiling, incorrect oil type (use a thin synthetic oil i.e. Dapoil, LocoLube™ or similar)
 - d. Fair wear and tear (unless deemed to be premature by Dapol or our service agent)
 - e. Routine maintenance and faults due to foreign bodies i.e. Drive tyres, Dirty wheels, Pickups etc.
 - f. Mishandling: Inclusive of broken wires, dislocated driveshaft's, damaged valve gear.
 - g. Mechanical or electrical modification; inclusive of fitting of DCC to a non DCC ready model. (Reasonable modifications inclusive of: Weathering, super detailing etc. are permitted, however any adverse effects of such modification shall invalidate the warranty.)
 - h. Unauthorised attempts to repair or modify the model.
7. This warranty is not transferable and is valid only for purchases made from authorised Dapol dealers when accompanied by a proof of purchase.
8. This warranty does not cover: Used models, models purchased from private individuals or auction sites (unless a 'Buy It Now' purchase of a new model from an authorised dealer when supplied with supporting proof of purchase).

Warranty

9. Dapol and its agents shall be the sole arbiters as to the warranty status of the model and their decision is final.
10. Whilst every effort will be made to protect such, Dapol and its agents shall not be liable for damage or alteration to any 'super detailing' or other aftermarket cosmetic, mechanical or electrical enhancements.
11. Dapol and its agents shall not be held liable for damage caused to inadequately packaged models.
12. Dapol and its agents shall not be held liable for models lost in the post unless a proof of posting can be supplied.
13. All repairs will be repaired on a first in-first out basis, within a reasonable period after receipt by our agent. Unless agreed in writing by Dapol or its agent prior to receipt of the model time shall not be of the essence in any contract.
14. All repairs and/or replacements are subject to availability

Dapol Limited.

Unit 7 Gledrid Industrial Park, Chirk, Wrexham
LL14 5DG

Telephone: 01691 774455

Website: www.dapol.co.uk

Email: sales@dapol.co.uk

Spares: dapolspares.dccsupplies.com