



Specialised Hardware.

Locks, Handles, Latches, Hinges, Attachments & More



powermaxgroup.com.au
FREECALL 1800 996 264

2nd Edition

INDEX

SECTION

A DOOR LOCKS HANDLES & LATCHES



B HANDLES - OTHER



C LATCHES CATCHES & FASTENERS



D HINGES



E BOLTS HASPS & RINGS



F MISCELLANEOUS

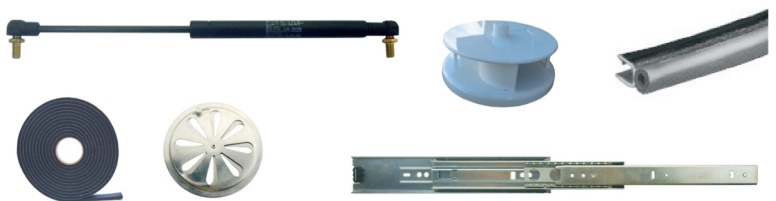

SPECIALISED HARDWARE

ALL SPECIFICATIONS ARE SUBJECT TO CHANGE WITHOUT NOTICE. E. & O.E.

FLUSH / RECESS MOUNT HANDLES

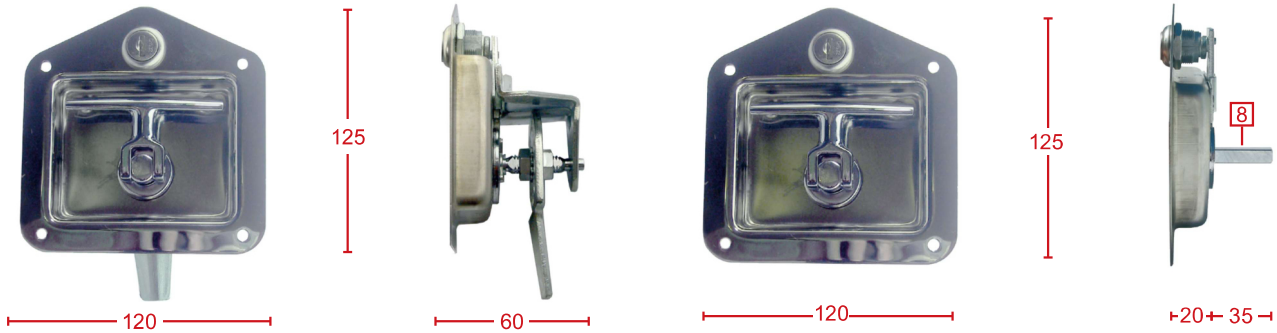

DROP T-HANDLE LOCK KEY LOCKING WITH TONGUE

- Very Common
- Adjustable Tongue

SH-062ZN Zinc

SH-062SS Stainless Steel (most common)

DROP T-HANDLE LOCK KEY LOCKING WITH SQUARE SHAFT

- For Handle Accessories - see Page A3

SH-093SS Stainless Steel

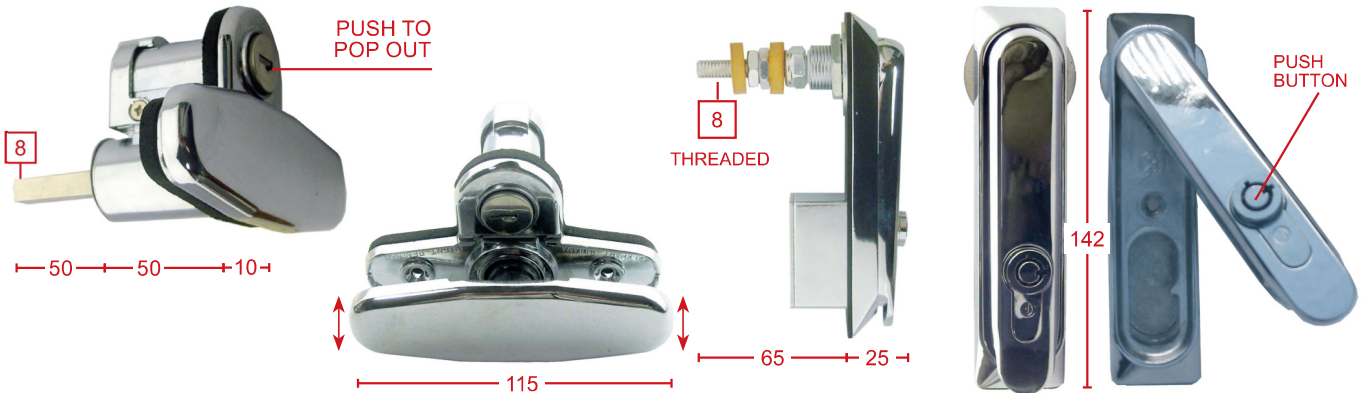

POP-OUT T HANDLE LOCK KEY LOCKING PUSH BUTTON - SEMI FLUSH

- Very Watertight
- Very Secure - difficult to break into
- For Handle Accessories - see Page A3

SH-203C Chrome

SH-203B Black Coated

SWING HANDLE KEY LOCKING PUSH BUTTON - SEMI FLUSH

- Compact, Strong & Waterproof to IP65
- Virtually Vandal-Proof
- Unique Key Style for greater security
- For Handle Accessories - see Page A3

SH-208 Chrome



DROP T-HANDLE 3PT ARM LOCK ASSY

- Key Locking
- Supplied with Handle, Arms & Fixing Bolts

SH-021SS Stainless Steel

FULL CHROME WHALE TAIL DROP T COMPRESSION LOCK

- Key Locking
- Supplied with Handle, Arms & Fixing Bolts

SH-064 Chrome

HANDLES - OTHER

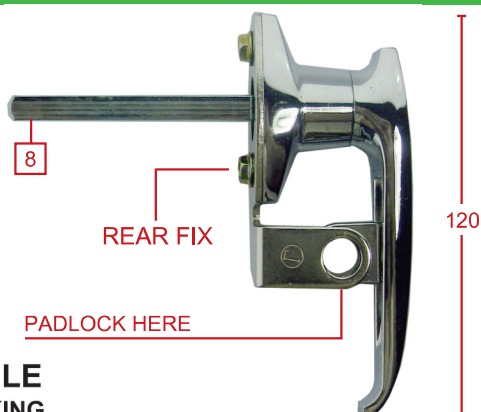

L-HANDLE PAD LOCKING

- For Handle Accessories - See Page A3
- Supplied with mounting hardware

SH-106 Chrome

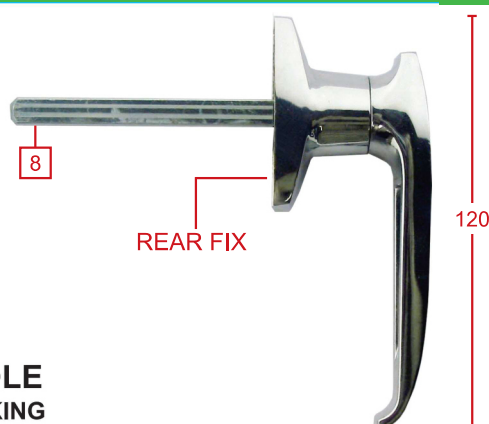

L-HANDLE KEY LOCKING

- For Handle Accessories - See Page A3
- Supplied with mounting hardware

SH-023 Chrome



T-HANDLE KEY LOCKING - NARROW HANDLE

- For Handle Accessories - See Page A3
- Supplied with mounting hardware

SH-024S Chrome



T-HANDLE KEY LOCKING - WIDE HANDLE

- For Handle Accessories - See Page A3
- Supplied with mounting hardware

SH-024W Chrome

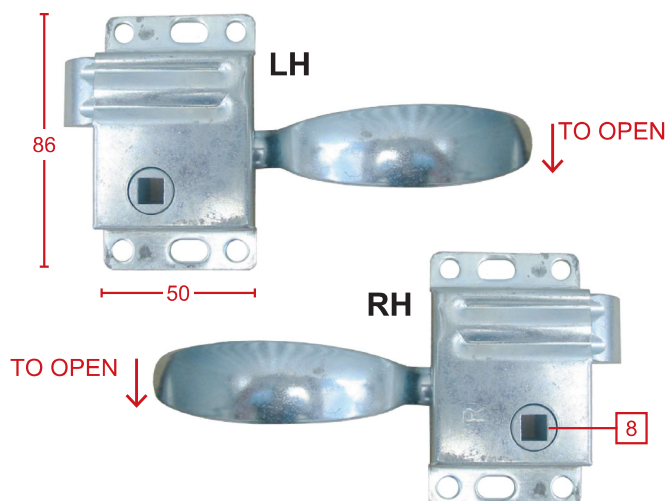

SPOON HANDLE LATCH

- Can be used as a latch on its own or Coupled with any handle with 8mm shaft to create a latch with a handle on both sides of the door

SH-017LH Left Hand Zinc

SH-017RH Right Hand Zinc

HANDLE ACCESSORIES

ALL ACCESSORIES FIT HANDLES WITH 8mm SHAFT

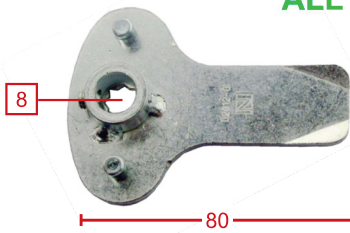

**LATCH LEG
PRESSED METAL**
• Multiple Position Hole

SH-116 Zinc

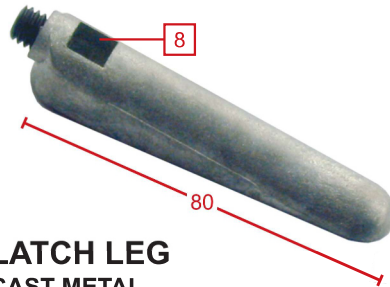

**LATCH LEG
CAST METAL**

SH-085 Zinc



**LATCH LEG
DOUBLE SIDED**

• One side of latch leg can be used as a handle

SH-015 Zinc

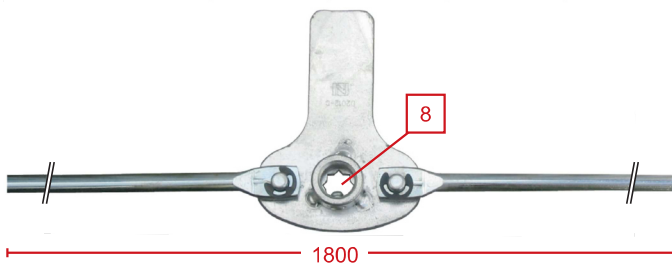

ARM LOCK SET

• Supplied as 3 Point
• If only 2 point arms are required, tongue can be docked

SH-115 Zinc

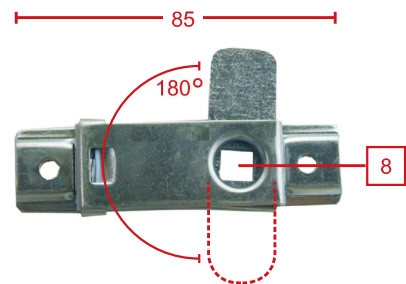

BUDGET LOCK

SH-120 Zinc

SLAM LATCHES & TRIGGER LATCHES

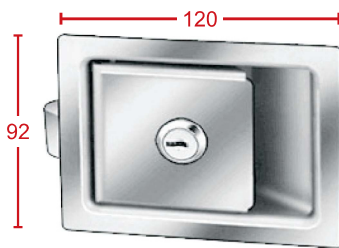

**SLAM LATCH
KEY LOCKING FLUSH MOUNT**
• Most Common

SH-063ZN Zinc

SH-063SS Stainless Steel

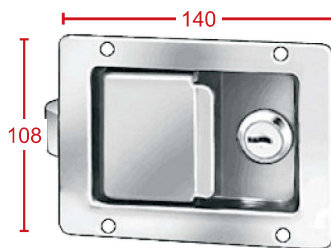

**SLAM LATCH
KEY LOCKING FLUSH MOUNT**
• Large Size

SH-064SS Stainless Steel



**SLAM LATCH
INTERNAL RELEASE FLUSH MOUNT**
• Internal knob allows door to be opened from the inside even if locked with key

SH-065 Zinc

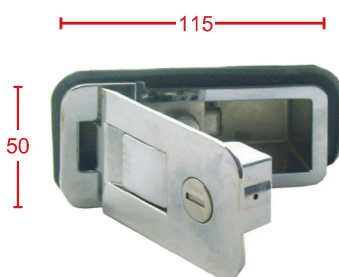

**TRIGGER LATCH
KEY LOCKING PUSH BUTTON - FLUSH MOUNT**
• Popular
• Supplied with mounting bracket & rubber seal

SH-195B Black

SH-195C Chrome

CAM LOCKS

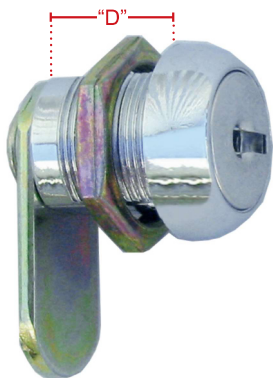

CAM LOCK KEY LOCKING

- Supplied with locking nut

SH-084/16 D = 16mm

SH-084/19 D = 19mm

SH-084/22 D = 22mm

GUN SAFE LOCKS

GUN SAFE LOCK ASSEMBLY

- Suitable lock & anti-drill plate as specified by the Firearms Act 1996*
- Sold as single or in a keyed-alike pair

SH-108 1 X Drill Plate, Lock & Strap

NOTE: A & B CATEGORIES ALSO REQUIRE:

- * 3 POINT LOCKING MECHANISM (SEE SH-115 ON PAGE A3)
- * A PADLOCKING "LEVER HANDLE" (SEE SH-106 ON PAGE A2)

SEE FIREARMS ACT 1996 FOR FULL DETAILS*

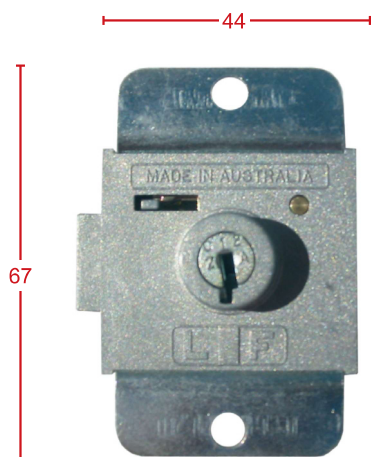
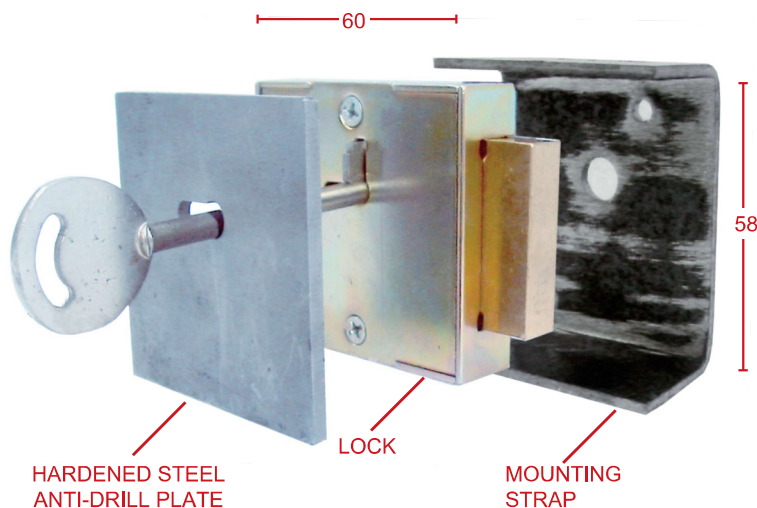

AMMO DOOR LOCK

- Suitable lock for ammunition safe. Ammunition Safe may be required to be separate from firearms safe - see the Firearms ACT 1996 for full details*

SH-109

* The above information is only a general guide to the products advertised. It is the responsibility of the customer to ensure that the applicable Government requirements are met (eg. Firearms Act 1996) and to select the appropriate Gun-Safe hardware. E.&O.E.

PANTECH / CONTAINER STYLE DOOR LATCHES

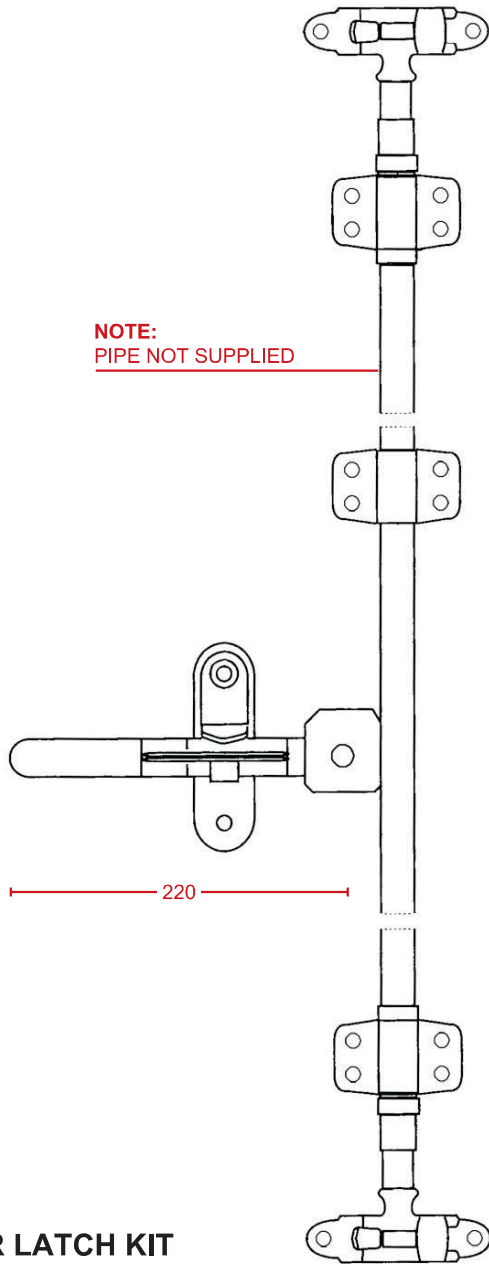

**DOOR LATCH KIT
HEAVY DUTY**

SH-044 Zinc

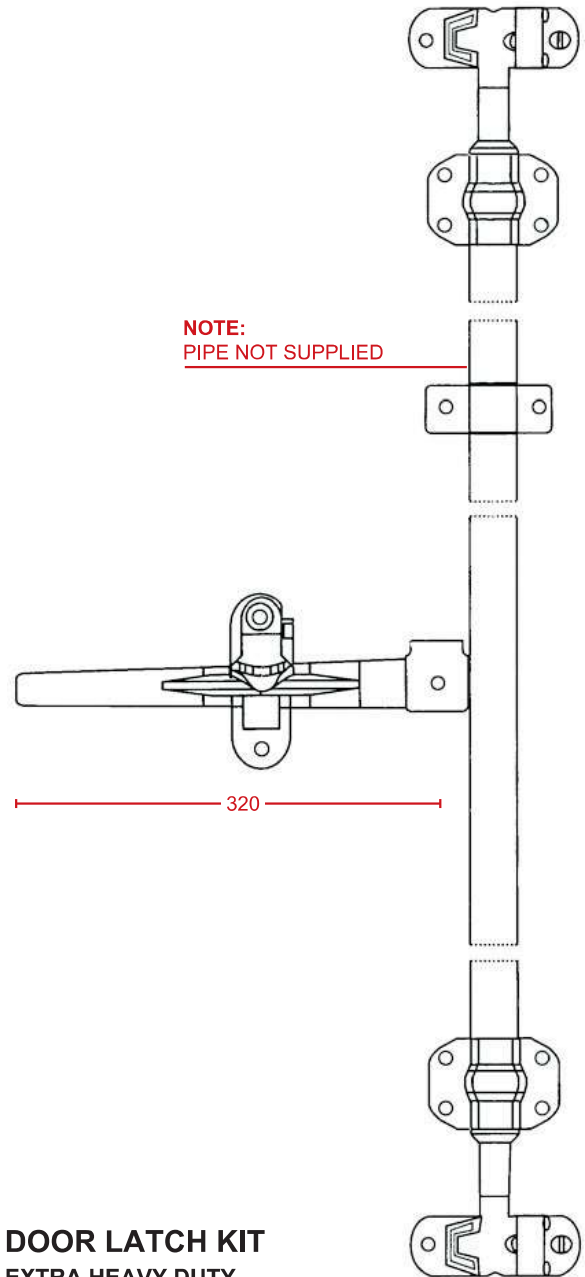

**DOOR LATCH KIT
EXTRA HEAVY DUTY**

SH-045B Zinc

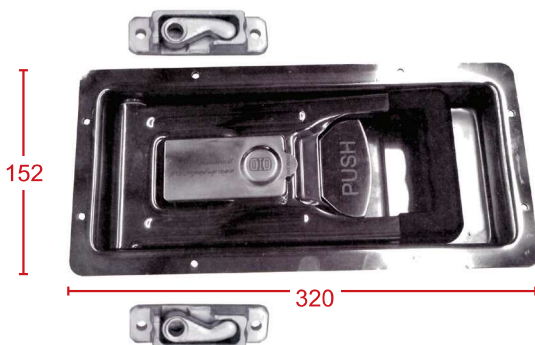

**DOOR LATCH KIT
RECESS / INTERNAL MOUNT**

- Locking mechanism mounts on the inside of door
- Only the recess mount handle is visible from outside

SH-211 Stainless Steel

CHEST HANDLES - DROP STYLE



CHEST HANDLE
2 PEICE

SH-077 Zinc D = 80mm

SH-077SML Zinc D = 60mm

SH-077SS Stainless D = 80mm



CHEST HANDLE
H/DUTY

SH-072 Zinc

CHEST HANDLES - SPRING LOADED

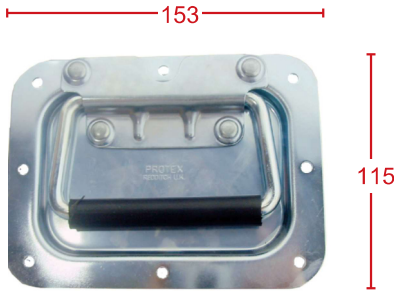

CHEST HANDLE
H/DUTY SPRING LOADED FLUSH MOUNT
SH-070 Zinc

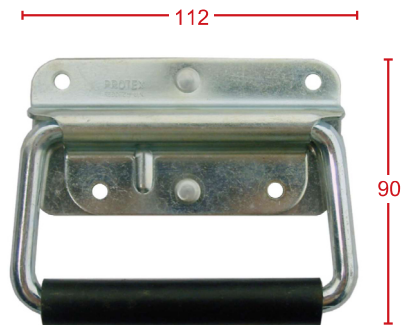

CHEST HANDLE
H/DUTY SPRING LOADED
SH-078 Zinc

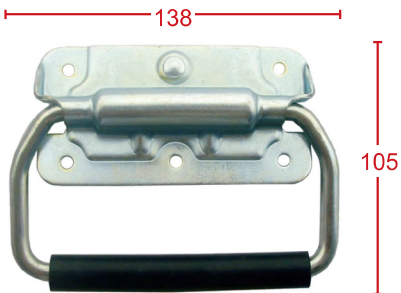

CHEST HANDLE
EXTRA H/DUTY SPRING LOADED
SH-071 Zinc

PULL HANDLES

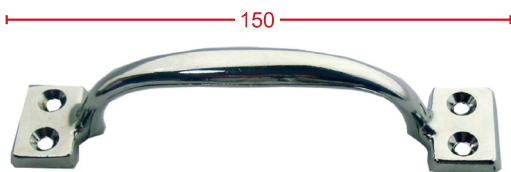

PULL HANDLE
SH-076A Chrome



PULL HANDLE
SH-073 Plastic

OVERCENTRE LATCHES

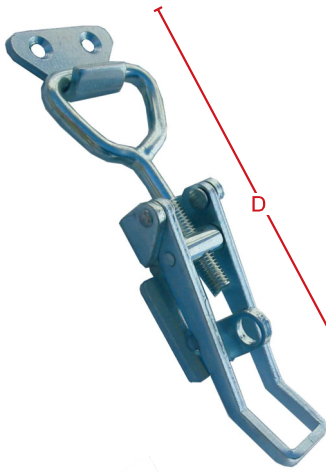

LATCH & CATCH ADJUSTABLE

- Very Common Style
- Can be Pad-Locked

SH-025B	Zinc	D= 98 - 105
SH-025BSS	Stainless	D= 98 - 105
SH-026	Zinc	D= 130 - 145
SH-026SS	Stainless	D= 130 - 145
SH-028	Zinc	D= 170 - 185
SH-028SS	Stainless	D= 170 - 185

NOTE: "D" Dimensions are approximate only

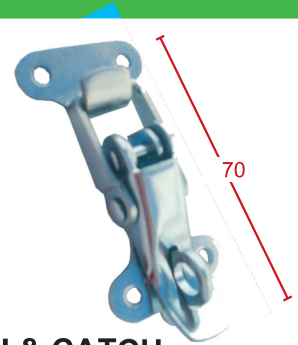

LATCH & CATCH NON ADJUSTABLE - SMALL

- Can be Pad-Locked

SH-029	Zinc
---------------	------



LATCH & CATCH NON-ADJUSTABLE

- Can be Pad-Locked

SH-030	Zinc
---------------	------



LATCH & CATCH NON-ADJUSTABLE

- Key Locking

SH-032	Zinc
---------------	------

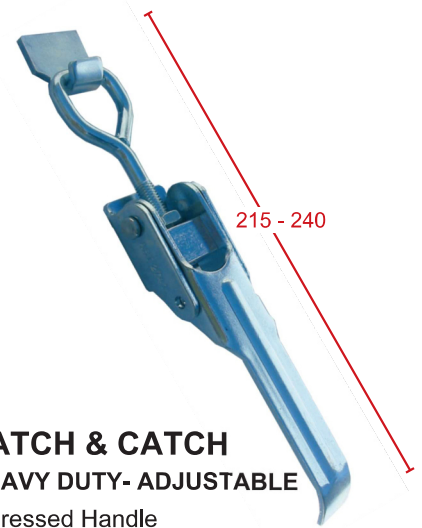

LATCH & CATCH HEAVY DUTY- ADJUSTABLE

- Pressed Handle

SH-110	Zinc
---------------	------

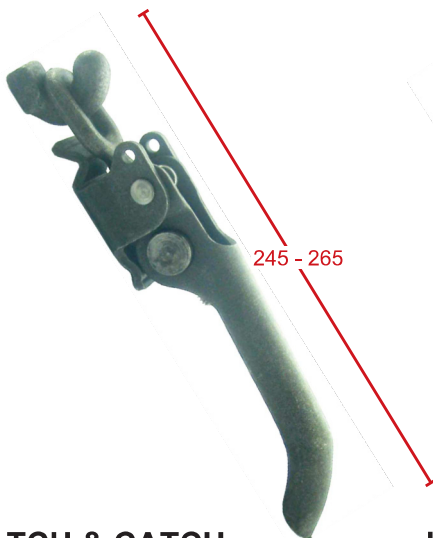

LATCH & CATCH EXTRA HEAVY DUTY - ADJUSTABLE

- Pressed Handle

SH-112	Black
---------------	-------



LATCH & CATCH EXTRA HEAVY DUTY - ADJUSTABLE

- Solid Handle

SH-113	Black
---------------	-------

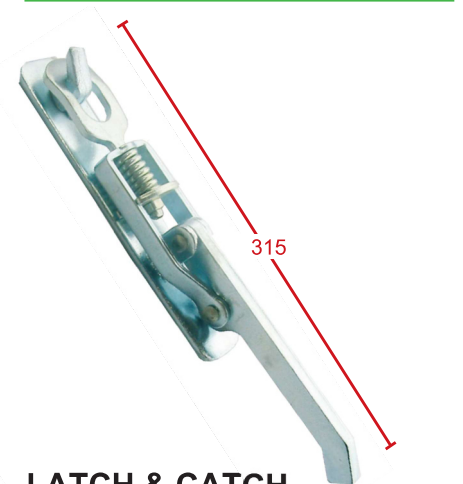

LATCH & CATCH EXTRA H/DUTY SPRING TENSIONED

- Supplied as one piece
- Catch Hook or back plate can be cut off as required

SH-172	Zinc
---------------	------

ANTI-LOOSE FASTENERS

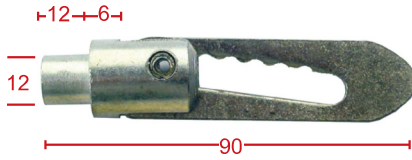

**ANTI-LOOSE FASTENER
WELD ON**
SH-036A Zinc

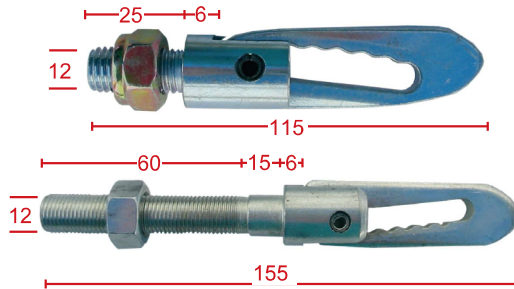

**ANTI-LOOSE FASTENER
BOLT ON**
SH-036B Zinc 25mm Thread
SH-036C Zinc 60mm Thread

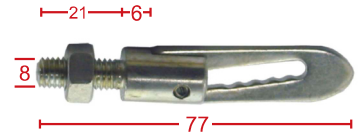

**ANTI-LOOSE FASTENER
MINI BOLT ON**
SH-171 Zinc

CORNER FASTENERS

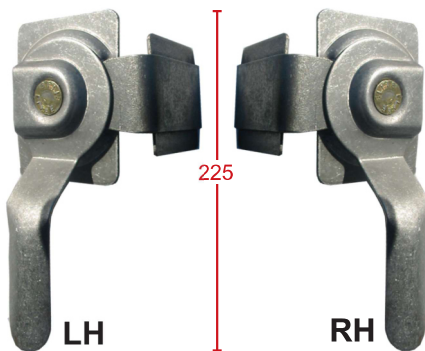

**CORNER FASTENER
WELD - ON**
SH-033SET FULL SET
2 X LH Latch & Catch
2 X RH Latch & Catch
SH-033LH 1 X LH Latch & Catch Only
SH-033RH 1 X RH Latch & Catch Only

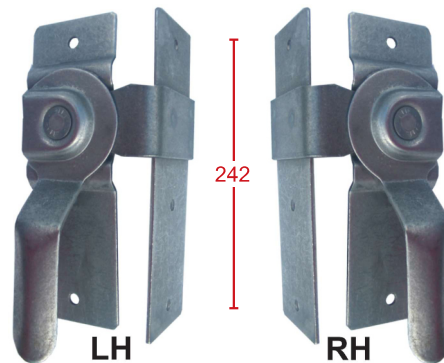

**CORNER FASTENER
BOLT - ON**
SH-034SET FULL SET
2 X LH Latch & Catch
2 X RH Latch & Catch
SH-034LH 1 X LH Latch & Catch Only
SH-034RH 1 X RH Latch & Catch Only

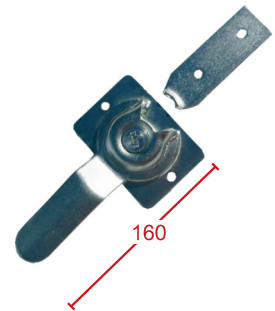

**CORNER FASTENER
MINI - ZINC**
• Universal LH or RH Application
• Weld-on or Bolt-on
SH-035 1 X Latch & Catch

DOOR HOLDS



DOOR HOLD - PLUG STYLE
• Holder: Rubber with steel base
• Plug: All plastic
SH-122

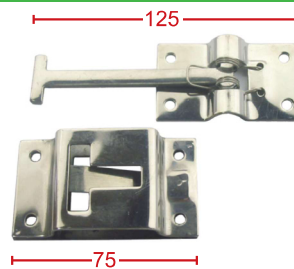

**DOOR HOLD - T HOOK STYLE
HEAVY DUTY**
• Holder incorporates retaining spring
SH-040 Stainless steel

BONNET CATCH

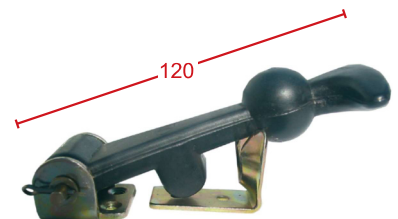

**BONNET CATCH
RUBBER**
SH-117

BULLET STYLE HINGES

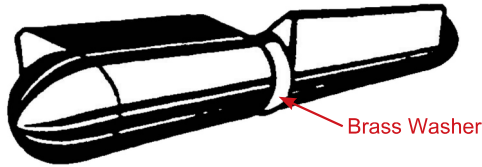

BULLET STYLE HINGE

- Very Popular
- Simple, Robust, Universal

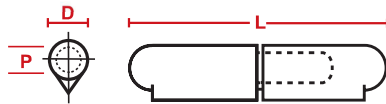

DIMENSIONS

P/No.	SH-139	SH-140	SH-141	SH-142	SH-143	SH-144	SH-145	SH-146	SH-147
L mm	40	60	80	80 Brass Pin	100	100 H/Duty	120	150	200
D mm	8	10	13	13	16	20	16	20	23
P mm	5	6	8	8	10	14	11	13	16

ALL BULLET STYLE HINGES ARE MILD STEEL WITH MILD STEEL PIN UNLESS OTHERWISE STATED.

BALL BEARING HINGES

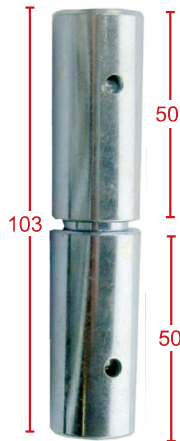

LH

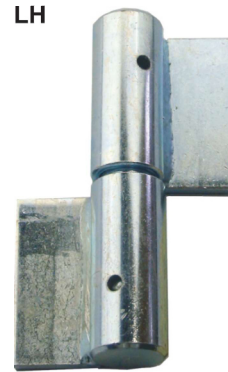

RH

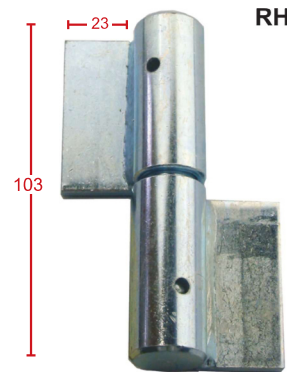

BALL BEARING HINGE H/DUTY CYLINDRICAL STYLE

- Sold per PR
- Ball Bearing enclosed in each end

SH-001 Zinc

BALL BEARING HINGE H/DUTY BUTT STYLE

- Sold per PR of 2 x LH or 2 x RH
- Ball Bearing enclosed in each end

SH-002LH Zinc LH

SH-002RH Zinc RH

LH



RH



BALL BEARING HINGE H/DUTY STRAP STYLE

- Sold per PR OF 2 X LH or 2 X RH
- Ball Bearing enclosed in end

SH-210 Zinc LH

SH-209 Zinc RH

WELD-ON FARM HINGES

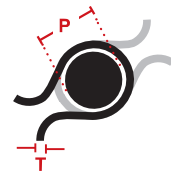
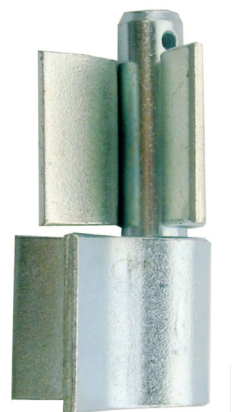

WELD-ON "FARM" HINGE

- Zinc

SH-127 L= 95 P=16 T=3

SH-196 L=120 P=20 T=5

SIDEBOARD HINGES

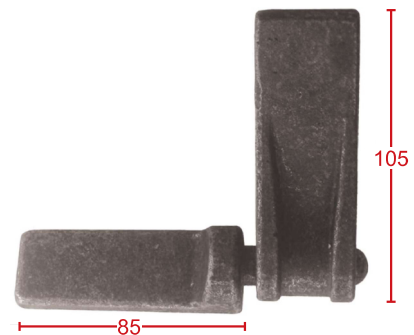
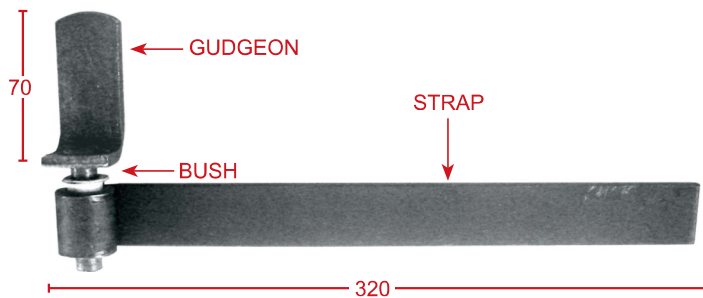

SIDEBOARD HINGE

STRAP STYLE 3PC

SH-107 Strap, Gudgeon & Bush (Black)

SH-107B Spare Bush only

SIDEBOARD HINGE

CAST STYLE 2PC

SH-206 Black

HEAVY DUTY DOOR HINGES



DOOR HINGE OFFSET

SH-052 Zinc

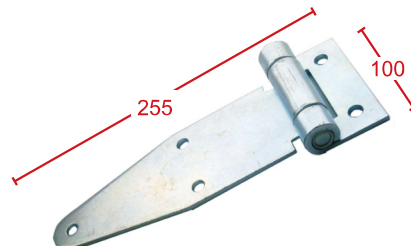

DOOR HINGE STRAIGHT

SH-053 Zinc

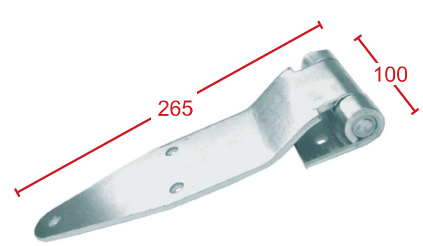

DOOR HINGE BENT

SH-054 Zinc

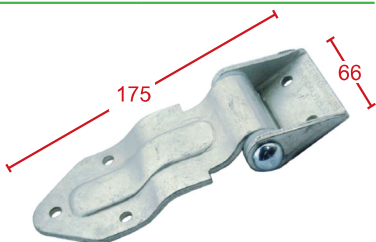

DOOR HINGE EXTRA H/DUTY

SH-048 Zinc

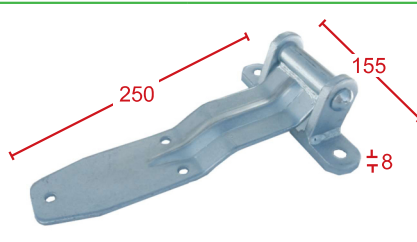

DOOR HINGE EXTRA H/DUTY

SH-050 Zinc

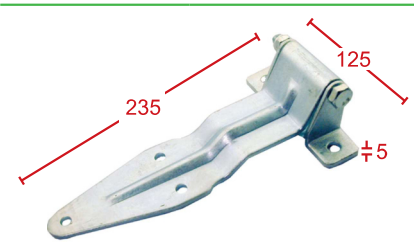

DOOR HINGE EXTRA H/DUTY

SH-051 Zinc

CABINET HINGE

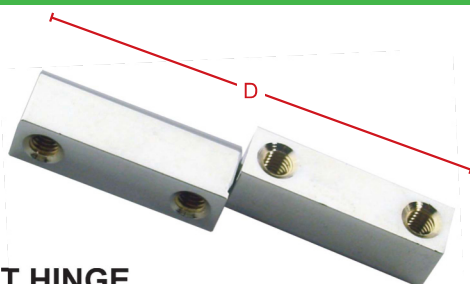

CABINET HINGE

• Supplied with fixing bolts

SH-105 Chrome D=50

SH-104 Chrome D=82

CHROME HINGE

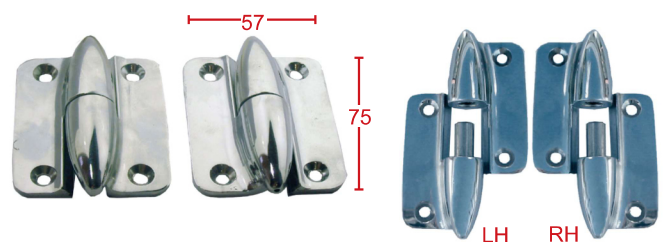

CHROME HINGE

• Sold Per each

SH-132LH L/H

SH-132RH R/H

BUTT HINGES

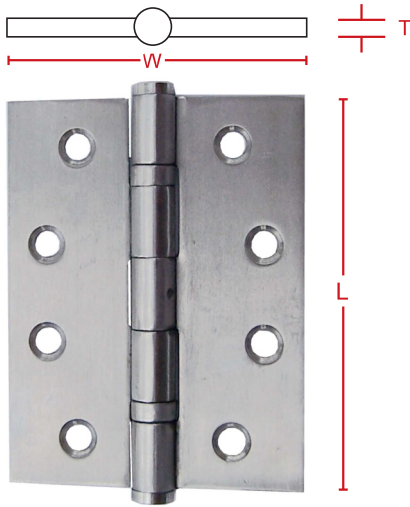

P/No.	TYPE	L	W	T
SH-162	Mild Steel	70	50	1.6
SH-161	Mild Steel	85	60	1.6
SH-159	Mild Steel	100	75	1.6
SH-160	Zinc	100	75	1.6
SH-158	Mild Steel	100	75	2.5
SH-157	Mild Steel	100	100	2.5
SH-180	Stainless Steel	50	40	1.2
SH-179	Stainless Steel	75	50	1.6
SH-178	Stainless Steel	100	75	1.8

CONTINUOUS HINGES

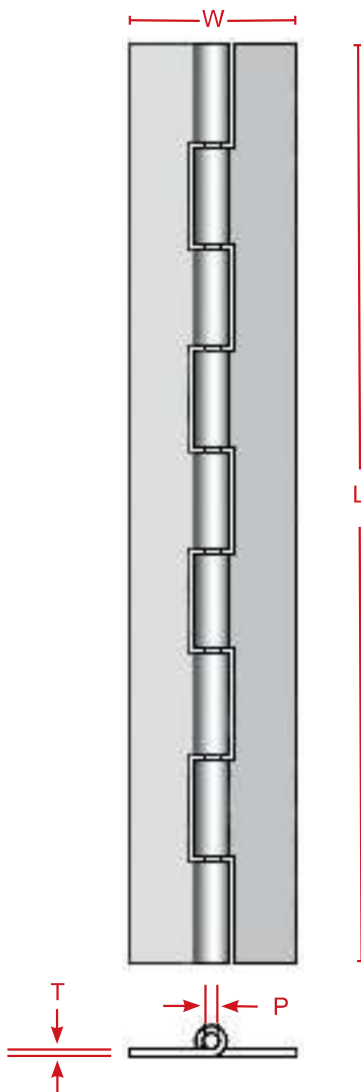

P/No.	TYPE	L	W	T	P
SH-148	Mild Steel	1800	38	1.2	3.15
SH-149	Mild Steel	1800	50	1.8	6.3
SH-150	Mild Steel W/Brass Pin	1800	50	1.5	5.0
SH-150G	Galvanised W/Brass Pin	1800	50	1.5	5.0
SH-152	Mild Steel	1800	101	3.0	8.0
SH-154	Stainless Steel	1800	38	1.5	5.0
SH-155	Stainless steel	1800	50	1.8	6.3

Note: P dimensions may vary slightly due to different manufacturers.

SPRING BOLTS

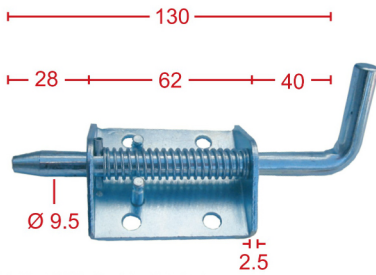

SPRING BOLT
HEAVY DUTY SMALL

- Weld-On or Bolt-On

SH-177 Zinc

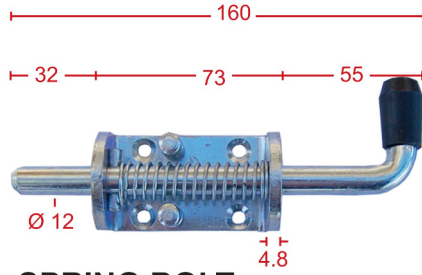

SPRING BOLT
HEAVY DUTY MEDIUM

- Weld-On or Bolt-On

SH-114 Zinc

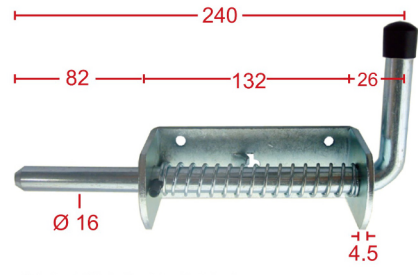

SPRING BOLT
HEAVY DUTY LARGE

- Weld-On or Bolt-On

SH-169 Zinc

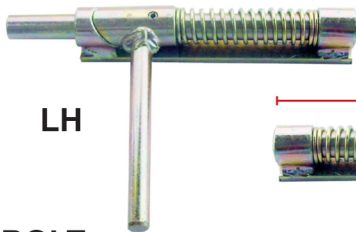

LH

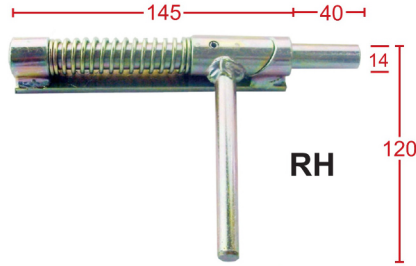

RH

SPRING BOLT
HEAVY DUTY FARM STYLE

- Weld-On
- LH or RH Handle option

SH-124ALH LH Zinc

SH-124ARH RH Zinc

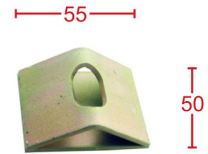

STRIKER PLATE

- Weld-On
- Suits SH-124A Spring Bolt

SH-124B Zinc

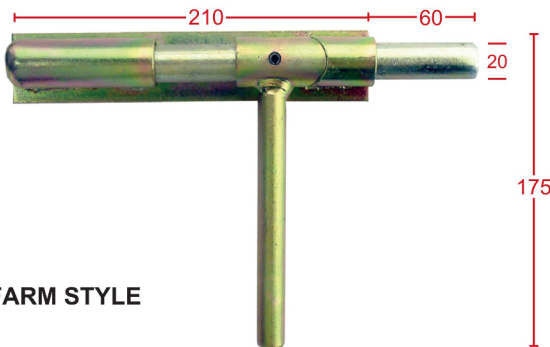

SPRING BOLT
EXTRA HEAVY DUTY FARM STYLE

- Weld-On
- Enclosed Spring
- RH Only

SH-125A RH Zinc

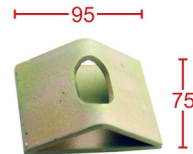

STRIKER PLATE

- Weld-On
- Suits SH-125A Spring Bolt

SH-125B Zinc

PAD BOLTS

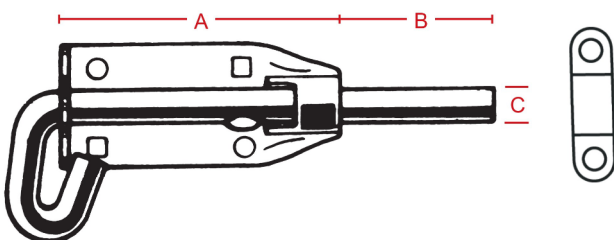

P/No.	FINISH	TYPE	A	B	C
SH-080	Zinc	Single Eye	70	30	8
SH-081	Zinc	Single Eye	110	25	8
SH-170	Zinc	Double Eye	90	70	12

HASP & STAPLES

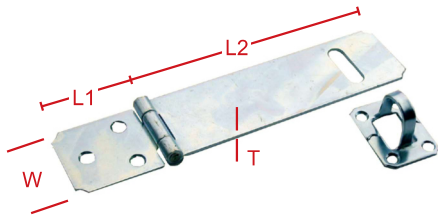

HASP & STAPLE MEDIUM DUTY

- Zinc

	L1	L2	W	T
SH-055	43	120	36	1.6
SH-056	43	155	36	1.6

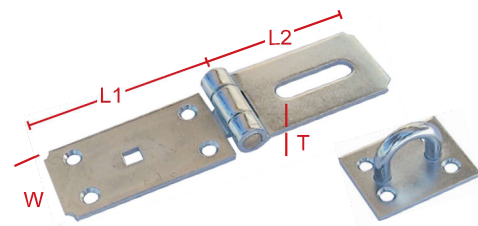

HASP & STAPLE EXTRA HEAVY DUTY

- Zinc with Brass Pin

	L1	L2	W	T
SH-057	100	85	48	3.5
SH-059C	140	95	50	4.5

LASHING RINGS

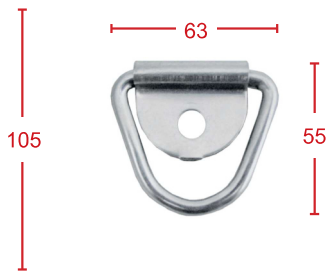

LASHING RING - SMALL

- Supplied with plastic semi-flush mounting bracket which can be used or discarded as required.

SH-192 Zinc

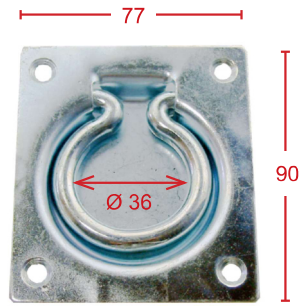

LASHING RING - MEDIUM

- Flush Mount

SH-041B Zinc

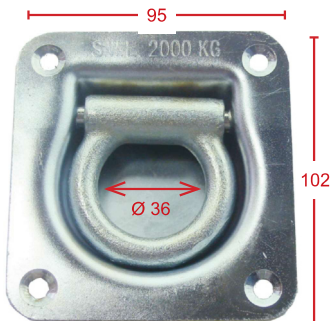

LASHING RING - LARGE EXTRA HEAVY DUTY

- Flush Mount
- Ring is non-removable (secured by a pin)

SH-042 Zinc

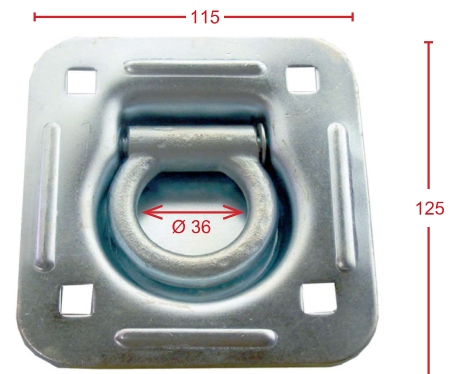

LASHING RING - LARGE EXTRA HEAVY DUTY - LARGE PAN

- Flush Mount
- Ring is removable (secured by a bolt)

SH-079 Zinc

GAS STRUTS

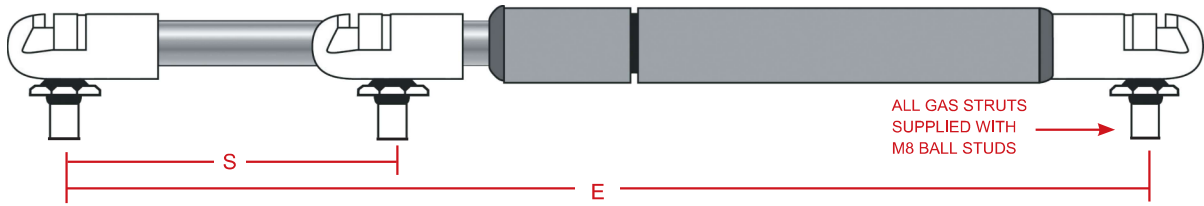

CALCULATING INSTALLATION OF GAS STRUTS

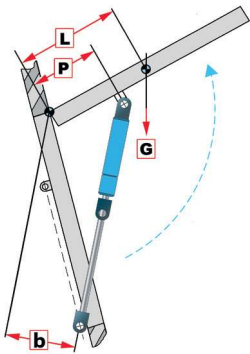

$$F1 = \frac{G \times L}{b \times n} \times 11$$

Example:
G = 30kg L = 400mm b = 200mm, n=2

$$F1 = \frac{30 \times 400}{200 \times 2} \times 11 = 330N$$

F1 = Pressure required for each gas strut (in Newtons)

G = Weight of flap in kg at the centre of gravity of the flap, allowing for door locks etc

L = Distance from centre of gravity to pivot point in mm

b = Effective lever arm of gas strut in mm, flap open

n = Number of gas struts (normally 2 per flap)

11 = Conversion factor from kg to N + safety margin

P = Distance from pivot point to point of attachment of gas strut - approx 2/3L

P/No:	E=EXTENDED LENGTH (mm)	S=STROKE (mm)	PRESSURE (N)
SH-181/...	315	120	100 / 200 / 250
SH-164/...	431	170	130 / 250 / 400
SH-165/...	501	200	150 / 250 / 350 / 450 / 600 / 900
SH-204 & 205	705	300	350 (SH-204) / 600 (SH-205)
SH-168/...	915	400	350 / 600 / 800 / 1000

9.81 Newtons = 1 Kilogram force



M8 BALL STUDS FOR GAS STRUTS

SH-212 10mm Ball

SH-213 13mm Ball



M8 NYLOC NUT FOR BALL STUDS

SH-214

NOTE: Due to the complexities involved in calculating the exact size & pressure of Gas Struts required, JAYMAC will **NOT** be held responsible if any Gas Strut supplied does not suit the intended application. Returns of Gas Struts will be accepted provided they are in original condition and any freight costs are paid by the customer.

ADHESIVE TAPE



MEDIUM HARDNESS POLYETHYLENE FOAM SELF-ADHESIVE

• Applications include sealing, gasketing, baffling, cushioning and insulating

SH-135 12mm X 6.4mm X 15mtr

SH-198 24mm X 3.2mm X 23mtr

SH-193 24mm X 6.4mm X 15mtr

SH-136 24mm X 9.5mm X 7mtr

HEAVY DENSITY VINYL SELF-ADHESIVE

• High density for durability & higher water proof protection etc

SH-202 18mm X 3.2mm X 15Mtr

PINCHWELD RUBBER SEAL

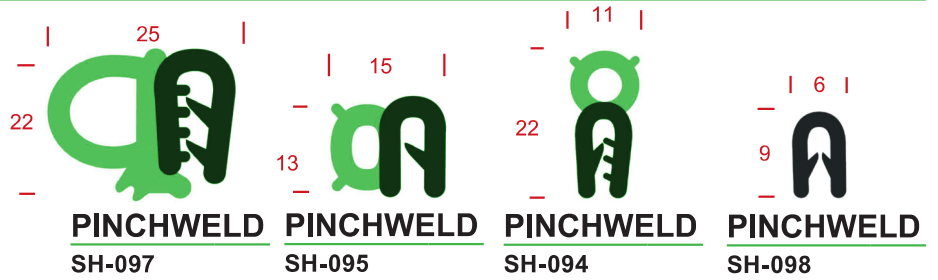

PINCHWELD
SH-097

PINCHWELD
SH-095

PINCHWELD
SH-094

PINCHWELD
SH-098

Note: Dimensions are for indication only and may vary

DRAWER SLIDES

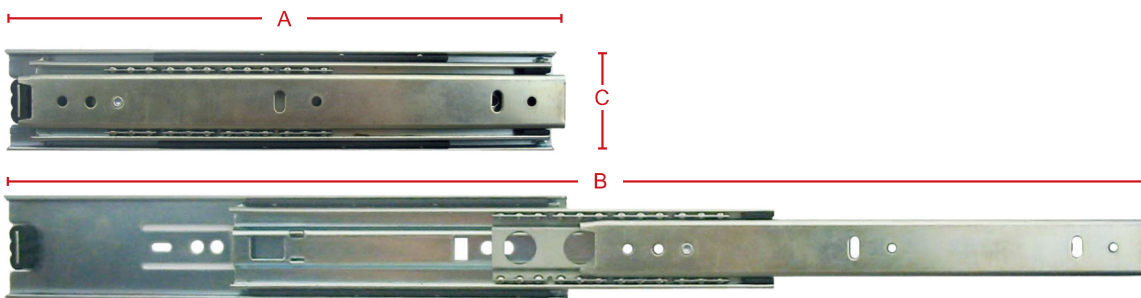

H/D SERIES - RATED AT 45KG / PR			
P/No:	A	B	C
SH-186	250	500	45
SH-187	350	700	45
SH-188	450	900	45
SH-189	550	1100	45

EXTRA H/D SERIES - RATED AT 100KG / PR			
P/No:	A	B	C
SH-183B	500	1000	75
SH-184B	600	1200	75

Other size drawer slides available on request

VENTS

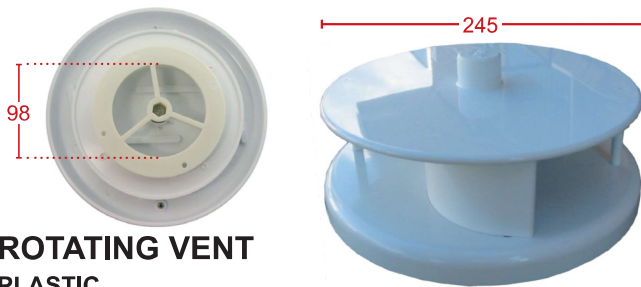

ROTATING VENT
PLASTIC
SH-134



RAT TRAP VENT
SH-089 A = 238 B = 148
SH-090 A = 265 B = 215



DAISY VENT
ALUMINIUM
• With Interior Control Knob
SH-038

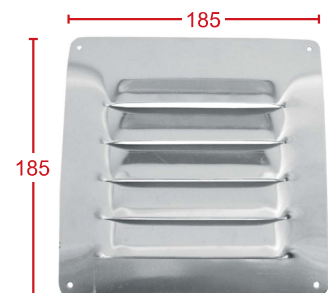

LOUVRE VENT
ALUMINIUM
SH-207