



Installation Instructions

<p>Rock Sliders – 2010-2012 Outback</p> <p>PN: RTEK-100406</p>	
<p>Suggested tools</p>	<ul style="list-style-type: none">• Ramps or jack stands• Jack• Drill• ¼” drill bit• Metric wrenches / sockets• Metric allen wrenches• Helper
<p>Safety Warnings</p>	<ul style="list-style-type: none">• Always support the vehicle with jack stands before working underneath• Use only the parts supplied by RalliTEK to install this kit• Check ALL the fasteners for tightness before and after road testing the vehicle• Do not use an air impact wrench with re-installing bolts as stripped threads may occur
<p>Install Time</p>	<ul style="list-style-type: none">• 4-6 hours

REMOVAL OF FACTORY UNDER TRAYS

1. Remove the plastic under trays that run lengthwise next to the pinch weld. Save any plastic clips you removed.

2. Remove the 2 outer bolts on each side for the subframe brace and also loosen the front subframe bolts. These are located near the rear subframe out towards the pinch weld.



3. 2010-2012 Models will need to remove the factory cover to reveal the front mounting point. You can find the covers on the frame supports at the back of the front inner fenders



RalliTEK ROCK SLIDER INSTALLATION

4. Using the arrows on the longer flange, identify the left and right base plates. The arrows will point to the front of the car. The passenger side base is shown.





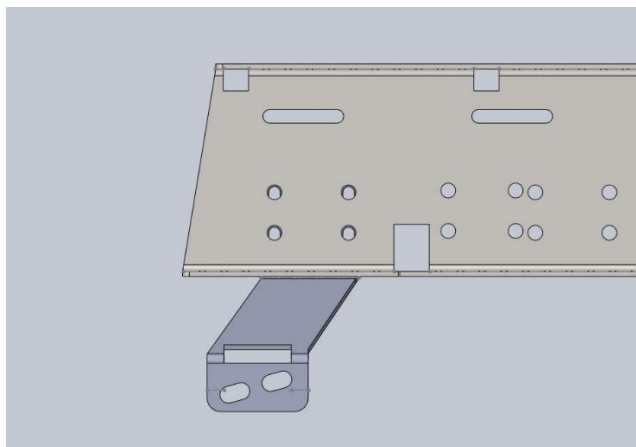

5. Install the braces onto the rock slider bases using the supplied M8 button head bolts and serrated nuts as shown. Be sure that the front brackets angle upwards from the

NOTE: The driver side front bracket will have a 5th hole in the 4 hole mounting pattern, the rear brackets are the same left and right. Tighten these bolts enough to still be able to move the brackets around on the base plate.



6. Take the rock slider base and brackets to their respective sides and start the bolts for the braces. The front brace will use the included M6x40mm bolts and the rear will use the included M10x30mm (no subframe drop) bolts or M10x70mm (with subframe drop) bolts. Install any subframe spacers between the rear rock slider brace and the subframe brace



	
<p>7. Rotate the rock slider base into position and mark the holes to be drilled in the pinch weld using a scribe or pick tool. It is helpful to support the front and rear of the rock slider base with jack stands while you mark the holes. Once you have marked the holes, remove the rock slider base and center punch near the bottom of the mark. Repeat the process for the other side.</p>	
<p>8. I recommend using a 1/8" drill bit to start drilling the mounting holes in the pinch weld and then stepping up to a 1/4" or 9/32" drill bit. Repeat the process for the other side.</p>	
<p>9. Loosely reinstall the rock slider base and let it hang from the bolts. Carefully install the rock slider top (they are the same left and right) and start the bolts to hold it to the base using the supplied M6 button head bolts and M6 serrated nuts.</p> <p>NOTE: only start the bolts a couple of threads</p>	
<p>10. Rotate the rock slider assembly up in to place and use jack stands to support the rock sliders while you install the M6x40mm bolts through the pinch weld. Use a 10mm wrench to hold the nut through the cut out while you start the bolt from the inside of the pinch weld. Once all the bolts on one side are installed, tighten the bolts that go through the pinch weld.</p>	

<p>NOTE: the rock sliders may need to be manipulated up or down to get the bolts to start into the nuts. I recommend applying a little tape to keep the nut on the wrench during this process.</p>	
<p>11. Once the bolts through the pinch weld are tight, tighten the bolts that go into the chassis, the 8 bracket bolts under the rock slider and all of the outer M6 screws. The nuts are serrated so you do not need to hold them while you tighten the bolts.</p>	
<p>12. Install the plastic under trays and trim the rear-most trays as shown to clear the rear brackets.</p>	

WARRANTY

One Year Limited Warranty

RalliTEK warrants to the original purchaser that the parts manufactured and/or sold by RalliTEK (the Product) is free from defects in material and workmanship under normal use. RalliTEK warrants that the Product will perform substantially in accordance with the specifications set forth in the documentation provided with it. The above express warranties are made for a period of the lesser of 12,000 miles or 12 months from the date the Product is installed in your vehicle.

Any improper use, operation beyond capacity, substitution of parts not approved by **RalliTEK** in writing, any alteration or repair by others, or any removal, defacing or altering of the identification shall void this warranty. There is no warranty on high-performance or race related parts due to the nature of usage.

The purchaser shall notify **RalliTEK** at 888-773-1212 of any defect within the warranty period no later than thirty (30) days after purchaser discovers the defect. Should any failure to conform to this warranty appear within the warranty period, RalliTEK shall, on notification, correct the nonconformity at its option, either by repairing any defective part, or by making available, FOB RalliTEK plant, a repaired or replacement part. The purchaser must insure any defective item being returned because RalliTEK does not assume risk of loss or damage while in transit. No payment or reimbursement shall be made for installation, removal, transportation or other charges. The remedies set forth in this instrument are exclusive, and the liability of RalliTEK with respect to any sale shall not exceed the price of the product on which the liability is based.

EXCEPT AS STATED OTHERWISE IN THIS WARRANTY, **RalliTEK** MAKES NO WARRANTIES, EXPRESS OR IMPLIED, INCLUDING WITHOUT LIMITATION, ANY WARRANTY OF MERCHANTABILITY OR FITNESS FOR A PARTICULAR PURPOSE. Some states do not allow limitations on how long an implied warranty lasts, so the above limitation may not apply to you. RalliTEK shall not in any case be liable for special, incidental, consequential, indirect, or other similar damages arising from any breach of these warranties even if RalliTEK or its agent has been advised of the possibility of such damages. Some states do not allow the exclusion or limitation of incidental or consequential damages so the above limitation or exclusion may not apply to you.

This warranty is governed by the laws of the State of Oregon.

