

FIRMAN[®]

OPERATOR'S MANUAL DUAL FUEL INVERTER GENERATOR

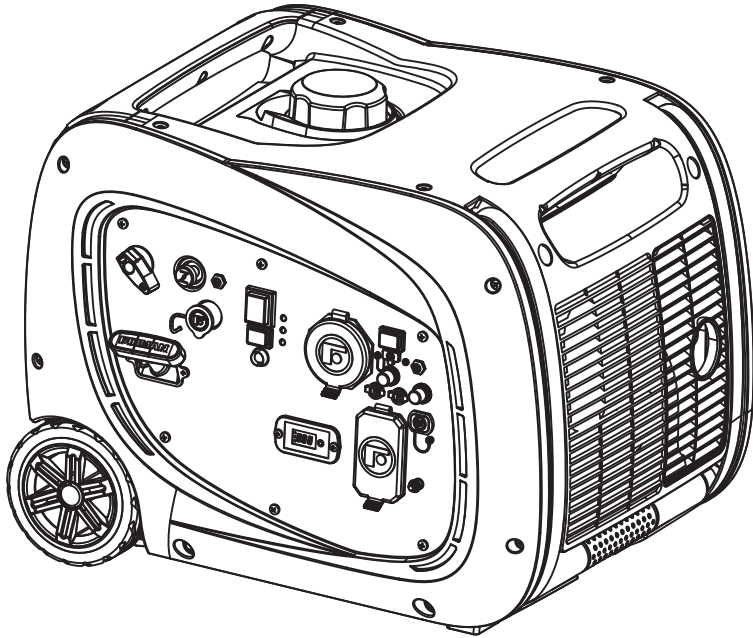

MODEL NUMBER
WH03242
Rev Level:01

Record product information to reference when ordering parts or obtaining warranty coverage.

SERIAL NUMBER: _____

PURCHASE DATE: _____

STOP DO NOT RETURN TO STORE!

CALL US FIRST
1-844-347-6261

FOR QUESTIONS OR SERVICE INFORMATION



Supplier's Declaration of Conformity
47 CFR § 2.1077 Compliance Information

FIRMAN WH03242 INVERTER GENERATOR

Firman Power Equipment

8644 W. Ludlow Dr.

Peoria, AZ 85381

Telephone: 1-844-347-6261

www.firmanpowerequipment.com

FCC/IC Compliance Statement

1. This device complies with Part 15 of the FCC Rules. Operation is subject to the following two conditions:

1a. This device may not cause harmful interference.

1b. This device must accept any interference received, including interference that may cause undesired operation.

2. Changes or modifications not expressly approved by the party responsible for compliance could void the user's authority to operate the equipment.

NOTE: The FIRMAN WH03242 inverter generator has been tested and found to comply with the limits for a Class B digital device, pursuant to part 15 of the FCC Rules. These limits are designed to provide reasonable protection against harmful interference in a residential installation. This equipment generates, uses and can radiate radio frequency energy and, if not installed and used in accordance with the instructions, may cause harmful interference to radio communications. However, there is no guarantee that interference will not occur in a particular installation. If this equipment does cause harmful interference to radio or television reception, which can be determined by turning the equipment off and on, the user is encouraged to try to correct the interference by one or more of the following measures:

- Reorient or relocate the receiving antenna.
- Increase the separation between the equipment and receiver.
- Connect the equipment into an outlet on a circuit different from that to which the receiver is connected.
- Consult the dealer or an experienced radio/TV technician for help.

Changes or modifications to equipment not expressly approved by FIRMAN could void the user's authority to operate the equipment.

INTRODUCTION

Table of Contents

Introduction	01
Features and Controls	05
Operation	11
Maintenance - Storage	27
Troubleshooting- Specifications	35
Parts Diagrams - Parts Lists - Wiring Diagram	37
Service - Warranty	43

REGISTER YOUR PRODUCT

Register your FIRMAN generator online at www.firmanpowerequipment.com



INTRODUCTION

Thank you for purchasing a FIRMAN generator. You have selected a high-quality, precision engineered generator set designed and tested to give you years of satisfactory service. This generator is Dual Fuel and capable of running on gasoline and liquid petroleum gas (LPG). This generator is not intended to be run unattended or to supply power to life safety support.

This manual contains safety information to make you aware of the hazards and risks associated with generator products and how to avoid them. This generator is designed and intended only for supplying electrical power for operating compatible electrical lighting, appliances, tools and motor loads, and is not intended for any other purpose. It is important that you read and understand these instructions thoroughly before attempting to start or operate this inverter generator. Save these original instructions for future reference.

All information in this publication is based on the latest production information available at the time of approval for printing. The manufacturer reserves the right to change, alter or otherwise improve the generator and this documentation at any time without prior notice.

SIGNAL WORDS

 DANGER	 WARNING	 CAUTION	NOTICE
Indicates a hazard which, if not avoided, will result in death or serious injury.	Indicates a hazard which, if not avoided, could result in death or serious injury.	Indicates a hazard which, if not avoided, could result in minor or moderate injury.	Indicates information considered Important, but not hazard-related.



Safety Alert Symbol- Indicates a potential personal injury hazard.



Operator's Manual- Failure to follow warnings, instructions and operator's manual could result in death or serious injury.



Toxic Fumes- Engine exhaust contains carbon monoxide, a poisonous gas that will kill you in minutes. You cannot smell it or see it.



Generator could cause electrical shock resulting in death or serious injury.



Fire- Fuel and its vapors are extremely flammable which could cause burns or fire resulting in death or serious injury. Engine exhaust could cause fire resulting in death or serious injury.



Hot Surface- Muffler could cause burns resulting in serious injury.

INTRODUCTION



WARNING! This product can expose you to chemicals including gasoline engine exhaust, which is known to the State of California to cause cancer, and carbon monoxide, which is known to the State of California to cause birth defects or other reproductive harm. For more information go to www.P65Warnings.ca.gov.

This outdoor generator can be used to power outdoor items using extension cords .

NOTICE If you have questions about intended use, contact FIRMAN customer service. This inverter generator is designed to be used only with FIRMAN authorized parts.

System Ground

The generator neutral is floating, which means that the AC stator winding is isolated from the grounding fastener and the AC receptacle ground pins. On a floating neutral generator the AC receptacle ground pins are not functional. Electrical devices, such as a ground fault circuit interrupter (GFCI), requiring a functioning AC receptacle ground pin will not operate.

Compliance Requirements

There may be Federal or State regulations, local codes, or ordinances that apply to the intended use of the generator. Consult a qualified electrician, electrical inspector, or the local agency having jurisdiction. This generator is not intended to be used at a construction site or similar activity as defined by NFPA 70-2020 (NEC) section 590.6.

To Restore Power Using Extension Cords

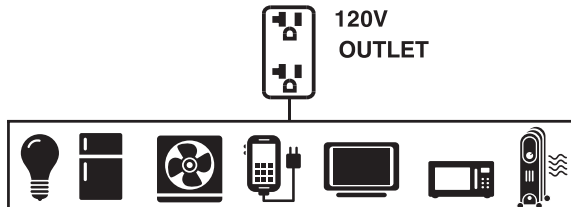

1. Only use grounded cords marked for outdoor use rated for your loads.

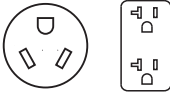
 To provide power using extension cords	
Total Amperage	Minimum Gauge, Outdoor Rated
	Up to 50 FT (15m)
Up to 13A	16
Up to 15A	14
Up to 20A	12
Up to 30A	10

2. Follow cord safety instructions.

3. Install carbon monoxide alarm(s).

4. When operating portable generator with extension cords, make sure portable generator is located in an open, outdoor area, at least 20 ft. (6 m) from occupied spaces with exhaust pointed away.

5. Extension cords running directly into your home, powering indoor items IS NOT RECOMMENDED.



DANGER! Engine exhaust contains carbon monoxide, a poisonous gas that will kill you in minutes. You cannot smell it, see it, or taste it. Even if you do not smell exhaust fumes, you could still be exposed to carbon monoxide gas.

- Extension cords running directly into the home increase your risk of carbon monoxide poisoning through any openings.
- If an extension cord running directly into your home is used to power indoor items, the operator recognizes that this increases the risk of CO poisoning to people inside the home and assumes that risk.

FEATURES AND CONTROLS

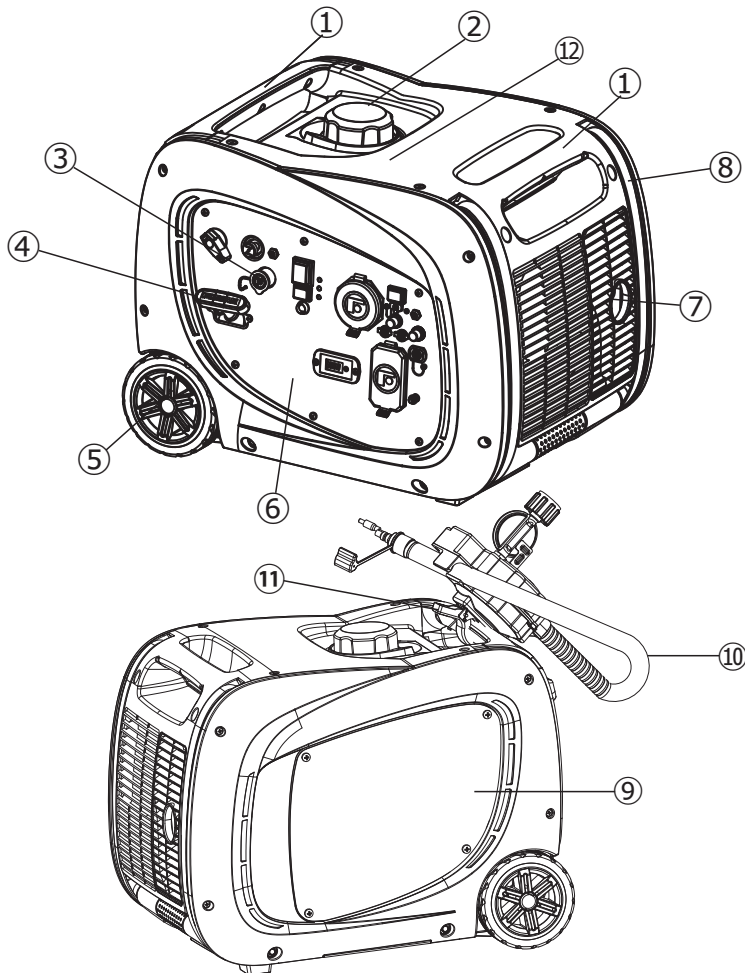

- 1- Fixed Carrying Handle**
- 2- Fuel Cap**
- 3- LPG Hose Quick Connect Inlet**
- 4- Recoil Starter**
- 5- Never Flat Wheel**
- 6- Control Panel**
- 7- Muffer/Spark Arrester**
- 8- Folding Handle**

- 9- Maintenance Cover – Oil filler and air filter access.**
- 10- LPG Hose with Regulator**
- 11- Spring Clamp to Hang Regulator on Handle**
- 12- Data Decal / Serial Number**





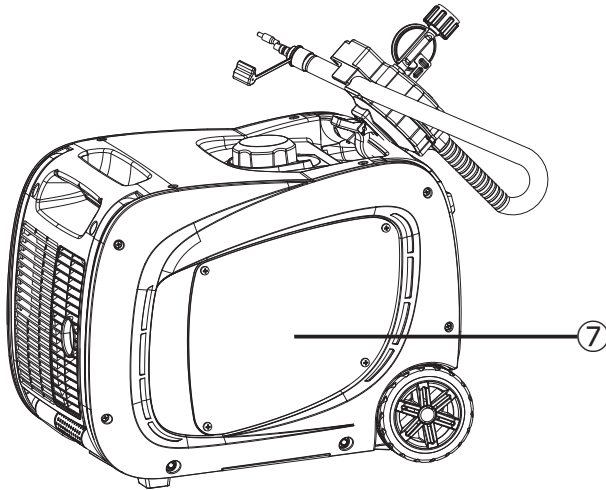
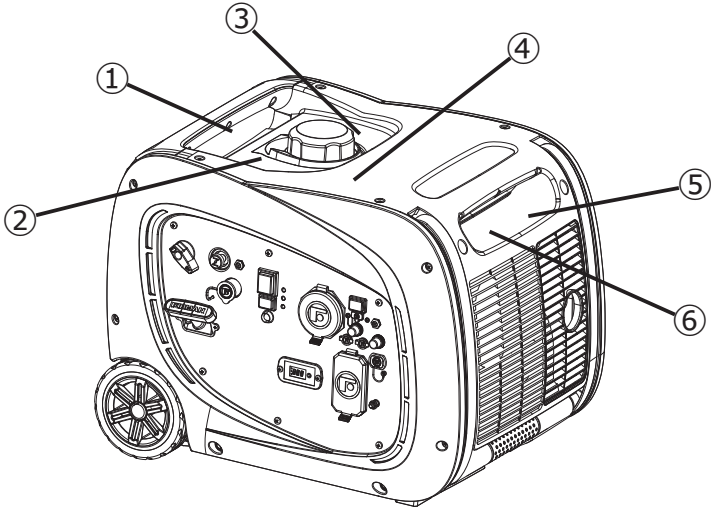





***We are always working to improve our products. Therefore, the enclosed product may differ slightly from the image on this page.**

FEATURES AND CONTROLS



FEATURES AND CONTROLS

①

⚠️ DANGER		⚠️ PELIGRO		⚠️ DANGER	
Using a generator indoors CAN KILL YOU IN MINUTES. Generator exhaust contains carbon monoxide. This is a poison you cannot see or smell.		Utilizar un generador en interiores PUEDE PROVOCARLA MUERTE EN CUESTIÓN DE MINUTOS. Los gases del generador contienen monóxido de carbono, el cual es una sustancia venenosa que no puede verse ni olerse.		Utiliser un générateur à l'intérieur PEUT VOUS TUER EN QUELQUES MINUTES. Les gaz d'échappement du générateur contiennent du monoxyde de carbone. Ceci est un poison que vous ne pouvez ni voir ni sentir.	
					
NEVER use inside a home or garage, EVEN IF doors and windows are open.		No utilice NUNCA el generador en el interior de su hogar ni en un garaje. NI SIQUIERA con las puertas y ventanas abiertas.		NE JAMAIS utiliser dans un garage ou à l'intérieur, MÊME avec les portes et les fenêtres ouvertes.	
					
Only use OUTSIDE and far away from windows, doors, and vents.		Utilice sólo AL AIRE LIBRE y lejos de ventanas, puertas y orificios de ventilación.		À n'utiliser qu'à l'EXTÉRIEUR et à distance de toutes fenêtres, portes et ouvertures.	

②



Fuel level indicator
Indicador de nivel de combustible
Indicateur de niveau de carburant

⚠️ WARNING

Fuel is flammable which could cause burns resulting in death or serious injury.

- Turn engine off and let it cool at least 2 minutes before refueling.
- Do not fill fuel above fuel level indicator.
- Never add fuel to a hot or running generator.

⚠️ ADVERTENCIA

El combustible es inflamable, lo que podría causar quemaduras resultantes en la muerte o lesiones graves.

- Apague el motor y déjelo enfriar al menos 2 minutos antes de recargar combustible.
- No llene el combustible por encima del indicador de nivel.
- No cargue nunca combustible en un generador caliente o en funcionamiento.

⚠️ AVERTISSEMENT

Le carburant est inflammable, ce qui peut provoquer des brûlures entraînant la mort ou des blessures graves.

- Éteindre le moteur et le laisser refroidir au moins 2 minutes avant le remplissage.
- Ne pas remplir au-delà de l'indicateur de niveau maximal de carburant.
- Ne jamais ajouter de carburant à une génératrice chaude ou en marche.

③

FOR RESIDENTS OF CALIFORNIA

⚠️ WARNING: This product and the engine exhaust from this product can expose you to chemicals including CO, which are known to the State of California to cause cancer or cause birth defects and other reproductive harm. For more information, go to www.P65Warnings.ca.gov.

PARA LOS RESIDENTES DE CALIFORNIA

⚠️ ADVERTENCIA: Este producto y el escape del motor de este producto pueden exponerlo a productos químicos, incluido CO, que en el estado de California son conocidos por causar cáncer o causar defectos de nacimiento u otros daños reproductivos. Para obtener más información, vaya a www.P65Warnings.ca.gov.

POUR LES RÉSIDENTS DE LA CALIFORNIE

⚠️ AVERTISSEMENT: Ce produit et l'échappement du moteur de ce produit peuvent vous exposer à des produits chimiques, y compris le CO, qui sont connus par l'État de Californie pour causer le cancer ou causer des malformations congénitales et autres problèmes de reproduction. Pour plus d'informations, visitez www.P65Warnings.ca.gov.

④

⚠️ AUTOMATIC SHUTOFF - YOU MUST:	⚠️ CORTE AUTOMÁTICO-DEBE REALIZAR LO SIGUIENTE:	⚠️ ARRÊT AUTOMATIQUE - VOUS DEVEZ:
 <p>20 FT. (PIES) (6 m) MIN.</p>	 <p>MUEVA EL GENERADOR A UN ÁREA ABIERTA AL AIRE LIBRE. APUNTE EL ESCAPE LEJOS DE LAS CASAS. NO UTILICE EL GENERADOR EN ÁREAS CERRADAS (EN CASA O EL GARAJE). VENTILE LAS INSTALACIONES (VENTANAS Y PUERTAS ABIERTAS) ANTES DE VOLVER A OCUPAR LA PROPIEDAD.</p>	 <p>DÉPLACEZ LA GÉNÉRATRICE DANS UN ESPACE EXTÉRIEUR OUVERT. ÉLOIGNEZ L'ÉCHAPPEMENT DES MAISONS. NE FAITES PAS FONCTIONNER LA GÉNÉRATRICE DANS DES ZONES FERMÉES (P. EX. PAS DANS LA MAISON NI DANS LE GARAGE). AÉREZ LES LIEUX (FÉNÊTRES ET PORTES OUVERTES) AVANT DE RÉNTEGRER LA PROPRIÉTÉ.</p>
 <p>MOVE TO FRESH AIR AND GET MEDICAL HELP IF SICK, DIZZY OR WEAK.</p>	<p>UBÍQUESE EN UN LUGAR DONDE CORRA AIRE FRESCO Y BUSQUE AYUDA MÉDICA SI SE SIENTE MAL, MAREADO O DÉBIL.</p>	<p>ALLEZ À L'AIR FRAIS ET OBTENEZ DE L'AIDE MÉDICALE EN CAS DE MALADIE, D'ÉTOURDISSEMENT OU DE FAIBLESSE.</p>

5

Point engine exhaust away from all occupied structures.



Mantenga los gases de escape del motor lejos de instalaciones ocupadas.













Pointer l'échappement du moteur loin de toutes les structures occupées.

6

NOTICE	AVISO	AVIS
To prevent engine damage the spark arrester should be cleaned every 100 hours. See Operator's manual.	Para evitar daños en el motor, el supresor de chispas debe limpiarse cada 100 horas. Consulte el manual del operador.	Pour éviter d'endommager le moteur, le pare-étincelles doit être nettoyé toutes les 100 heures. Consulter le manuel d'utilisation.

7

	⚠ DANGER	⚠ PELIGRO	⚠ DANGER
	Failure to follow warnings, instructions and operator's manual will result in death or serious injury.	El incumplimiento de las advertencias, las instrucciones y el manual del operador provocará la muerte o lesiones graves.	Le non-respect des avertissements, des instructions et du manuel de l'opérateur entraînera la mort ou des blessures graves.
	Tampering with the CO ALERT system will cause Carbon Monoxide poisoning. Install Carbon Monoxide alarms inside home.	La alteración del sistema de alerta de CO causará envenenamiento por monóxido de carbono. Instale detectores de Monóxido de Carbono dentro de su casa.	Toute altération du système d'ALERTE du monoxyde de carbone causera un empoisonnement au monoxyde de carbone. Installez des détecteurs de monoxyde de carbone à l'intérieur de la maison.
	Generator could cause electrical shock. Do not run indoors to avoid wet conditions. Do not run in rain or wet weather.	El generador podría producir una descarga eléctrica. No utilice en interiores para evitar condiciones de humedad. No utilice en la lluvia o en condiciones de humedad.	La génératrice pourrait provoquer un choc électrique. Ne faites pas fonctionner à l'intérieur pour éviter les conditions humides. Ne faites pas fonctionner sous la pluie ou par temps pluvieux.
	Hot exhaust gases could cause fires. Keep at least 5ft. (1.5m) clearance from any combustibles or structures, including overhead.	Los gases calientes de salida podrían causar incendios. Manténgase a una distancia mínima de 1.5m de cualquier combustible o estructura, incluyendo lugares elevados.	Les gaz d'échappement chauds peuvent provoquer des incendies. Gardez au moins 5 pi (1.5 m) de dégagement de tout combustible ou de toute structure, y compris au-dessus.
	⚠ WARNING	⚠ ADVERTENCIA	⚠ AVERTISSEMENT
	Liquid Petroleum gas (LPG) is extremely flammable which could cause burns or fire resulting in death or serious injury. If you smell gas, close tank valve and call qualified plumber. Do not place a fire source in the path of muffler outlet.	El Gas Licuado de Petróleo (GLP) es extremadamente inflamable, lo que puede causar quemaduras o incendios resultantes en la muerte o lesiones graves. Si huele gas, cierre la válvula del tanque y llame a un plomero calificado. No coloque la fuente de GLP en la trayectoria de salida del silenciador.	Le gaz de pétrole liquide (GPL) est extrêmement inflammable et pourrait causer des brûlures ou un incendie entraînant la mort ou des blessures graves. Si vous sentez une odeur de gaz, fermez le robinet du réservoir et appelez un plombier qualifié. Ne placez pas la source de GPL dans la trajectoire de la sortie du silencieux.
	NOTICE	AVISO	AVIS
	Operate, store and transport on firm level surface. • Tilling can cause fuel spillage.	Operar, almacenar y transportar en una superficie firme y nivelada. • Inclinarse puede causar un derrame de combustible.	Faire fonctionner, entreposer et transporter sur une surface ferme et horizontale. • L'inclinaison peut causer un déversement de carburant.
	171 cc (6.000ml) 193 cc (6.800ml) Add lubricant to full mark to start. Engine will not start or will shut off if sensor detects low lubricant.	Añada lubricante hasta la marca de lleno para arrancar. El motor no arranca o se apaga si sensor detecta el nivel de lubricante de baja.	Pour commencer, ajoutez du lubrifiant jusqu'à la marque. Le moteur ne démarra pas ou s'arrêtera si le capteur détecte un manque de lubrifiant.
			
Open Abrir Ouvrez	Spark Plug Maintenance Mantenimiento de la bujía Entretien de la bougie	Oil Maintenance Mantenimiento de aceite Entretien de l'huile	

FEATURES AND CONTROLS

Control Panel

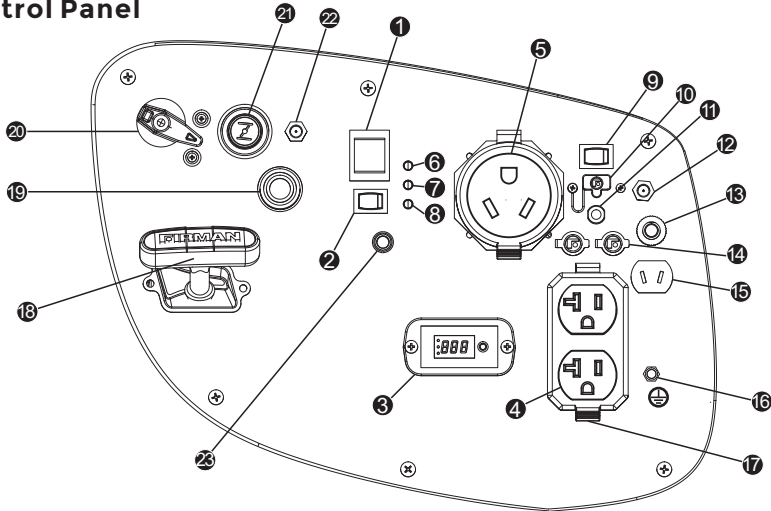

NOTICE Total power drawn from all receptacles must not exceed the data decal rating.

- 1. Engine Start Switch** - To start engine, press and hold the switch in the START (II) position, the engine will crank and attempt to start. When the engine starts, release the switch to the RUN (I) position.
- 2. Economy Control Switch** - The Economy Control switch can be activated in order to minimize fuel consumption and noise while operating the unit during times of reduced electrical output, allowing the engine speed to idle during periods of non-use. The engine speed returns to normal when an electrical load is connected. When the economy switch is off, the engine runs at normal speed continuously.
- 3. 3-1 Data-Minder (Multi-Meter)** - Push the SELECT button to show the Voltage, Hertz and running hours.
- 4. 120V, 20A Duplex** - NEMA 5-20R (Not GFCI protected)
A maximum of 20 Amps current may be drawn from this duplex receptacle.
- 5. 120V, 30A RV** - NEMA TT-30R
A maximum of 26.7 Amps current may be drawn from this receptacle.
- 6. Output Ready Indicator Light** - Remains "ON" during normal operating conditions. Shuts "OFF" when generator is overloaded. The green AC Power Indicator Light comes on when the engine starts and generates power.
- 7. Overload Indicator Light** - This light turns "ON" when the generator is overloaded and will cut power to the receptacles. If the engine overload indicator light comes on, the generator's wattage / amperage capacity has been exceeded by connected electrical devices or by a power surge. When this occurs, the green AC Power Indicator Light will go off. The engine will continue to run, but the red Engine Overload Indicator Light will stay on and power will no longer be supplied to connected electronic devices.
- 8. Oil Warning Indicator Light** - Check oil level when this light turns "ON". Engine will not run when indicator is lit. When the oil falls below the minimum level, the oil warning indicator light comes on and the engine stops automatically. The engine will not start until the proper amount of oil is in the crank case.

9. Battery Power Restore Switch

10. DC 5V 2.1A USB Outlet

11. **Circuit Breakers** - The receptacles are protected by AC circuit protectors. If the generator is overloaded or an external short circuit occurs, a circuit protector may trip. If tripping occurs, disconnect all electrical loads and determine the cause before attempting to continue using the generator. Reset any tripped circuit protectors.

If multiple receptacles are used at the same time, the total current must be kept within the portable generator data decal rating.

12. **12V DC Battery Charger Port** - Plug the 120 Volt AC charger into this port to charge the generator battery.

13. **DC Circuit Breaker** - The DC receptacles are protected by an DC circuit protector. If the DC output is overloaded or an external short circuit occurs the circuit protector will trip.

14. **Parallel Operation Outlets** - These outlets are used for connecting two FIRMEN inverter generators for parallel operation. A FIRMEN parallel kit (optional equipment) is required for parallel operation.

15. **DC 12V Output** - 8.3 Amps of DC current may be drawn from this receptacle. Use this outlet to charge 12V automotive type batteries ONLY. See 12V DC outlet (Battery Charger) section.

16. **Ground Terminal** - Consult an electrician or authority having jurisdiction for local grounding requirements.

17. **Outlet Cover** - Protect the receptacles from dust and debris.

18. Recoil Starter

19. **LPG Hose Connector (Inlet: 3/8" Flare Male)** - Used to connect LPG hose to generator.

20. **Fuel Selector Switch** - Use to select and turn on gasoline or LPG fuel source. Fuel (gasoline) valve is closed when the switch is on "OFF" or "LPG" positions. Engine switch is on when the switch is on "GAS" or "LPG" positions.

21. **Choke Knob** - Used to start a cold engine.

22. LPG Regulator Solenoid Port

23. **CO Alert™ Carbon Monoxide (CO) Shutdown Indicator Light** - Indicates the engine shutdown due to carbon monoxide accumulation around the generator or a CO Alert system fault occurred.

OPERATION

1. Location



DANGER! Engine exhaust contains carbon monoxide, a poisonous gas that could kill you in minutes. You **CANNOT** smell it, see it, or taste it. Even if you do not smell exhaust fumes, you could still be exposed to carbon monoxide gas.

- Operate portable generator only outdoors, at least 20 ft. (6 m) from occupied spaces with exhaust pointed away to reduce the risk of carbon monoxide accumulating.
- Install battery-operated carbon monoxide alarms or plug-in carbon monoxide alarms with battery back-up according to the manufacturer's instructions. Smoke alarms cannot detect carbon monoxide gas.
- Do not run this portable generator inside homes, garages, basements, crawlspaces, sheds, or other partially-enclosed spaces even if using fans or opening doors and windows for ventilation. Carbon monoxide can quickly build up in these spaces and can linger for hours, even after this product has shut off.
- If you start to feel sick, dizzy, weak or your home's carbon monoxide alarm sounds, get to fresh air right away. Call emergency services. You may have carbon monoxide poisoning.

Carbon Monoxide Alarm(s)

Install carbon monoxide alarms inside your home. Without working carbon monoxide alarms, you will not realize you are getting sick and dying from carbon monoxide poisoning.

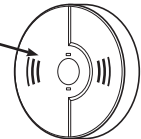

Prevent Carbon Monoxide (CO) Poisoning

Use outdoors at least 20 ft. (6 m) from any home.
Point exhaust away from all homes and occupied spaces.
Install CO alarms inside your home.



20 ft. (6 m) min.

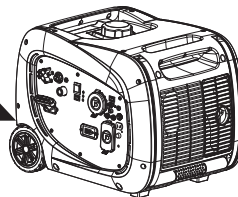

To better educate yourself about all carbon monoxide risks, go to www.takeyourgeneratoroutside.com.

Reduce Risk of Fire



WARNING! Exhaust heat/gases could ignite combustibles, structures or damage fuel tank causing a fire, resulting in death or serious injury.

- Keep portable generator at least 5 ft. (1.5 m) from any structure, trees or vegetation over 12 in. (30 cm) in height.
- Select an outdoor site that is dry and protected from the weather. Do not move portable generator indoors to protect it from the weather.
- Do not locate the portable generator under a deck or other similar structure that may confine heat and airflow.

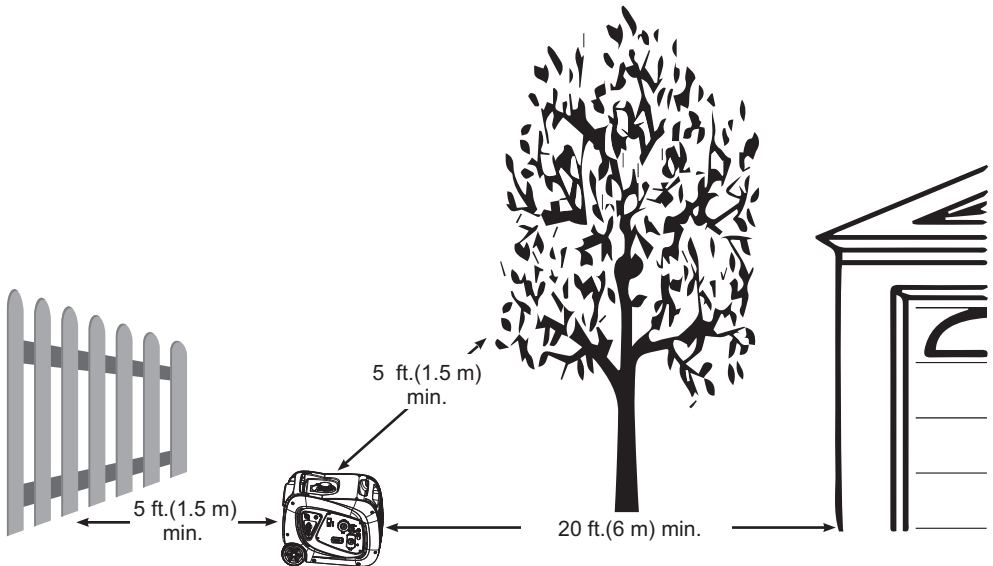

OPERATION

2. Oil and Gasoline/LPG

Add Engine Oil

We recommend using FIRMAN SAE 10W-30 API SJ oil for best performance. Other high-quality detergent oils (API SJ or higher) are acceptable. Do not use special additives. Ambient temperature determines the proper oil viscosity for the engine. Use the chart to select the proper oil for the outdoor temperature range expected.

NOTICE Do not attempt to crank or start the engine before it has been properly filled with the recommended type and amount of oil. Damage due to operation with no oil will void your warranty.

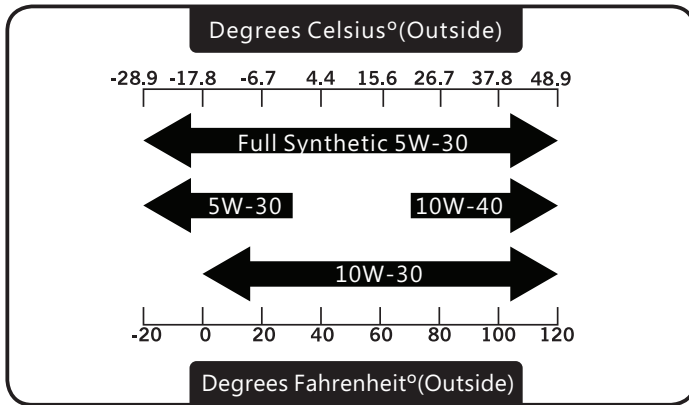

1. Place generator on a flat, level surface.
2. Loosen the cover screw and remove the maintenance cover.
3. Clean area around oil fill and remove yellow oil fill cap/dipstick.
4. Wipe dipstick clean.

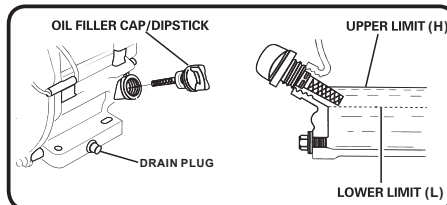
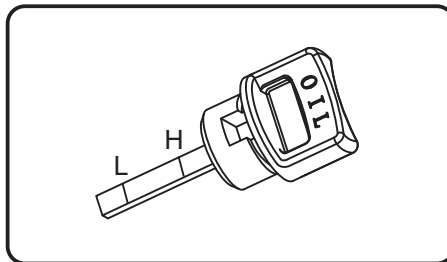

5. Using oil funnel, slowly pour contents of provided oil bottle into oil fill opening until oil reaches upper limit "H" mark on the dipstick. Be careful not to overfill. Overfilling could cause engine starting problems or engine damage.

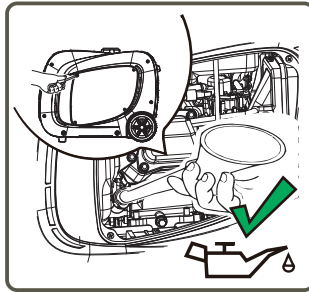

6. Replace oil fill cap/dipstick and fully tighten.

7. Reinstall maintenance cover and tighten screws.

8. Oil level should be checked prior to each use or at least every 8 hours of operation. Keep oil level maintained.

Low Oil Shutdown

The portable generator is equipped with a low oil shutdown. If the oil level drops below the minimum required level, a sensor will activate an internal switch stopping the engine. If the engine shuts off and the oil level is within specifications, check to see if generator is sitting at an angle. Place portable generator on an even surface to correct this. If engine fails to start, the oil level may not be high enough to deactivate the internal low oil level switch. Make sure the sump is completely full of oil to the upper limit (H). Do not operate engine until oil level issue is corrected. Contact Firman customer service.

Add Gasoline



WARNING! Fuel and its vapors are extremely flammable which could cause burns or fire resulting in death or serious injury.

- Turn generator engine OFF and let it cool at least 2 minutes before removing fuel cap.
- Do Not refuel or move generator when engine is running.
- Move generator outdoors prior to adding or draining fuel
- Keep fuel away from any ignition sources.
- Do not overfill tank, allow space for fuel expansion.
- If any fuel spills, wait until it evaporates before starting engine
- Check and replace fuel lines, tank, cap, and fittings prior to each use if any damage or leaks are found.

Fuel must meet these requirements:

- Clean, fresh, unleaded gasoline with a minimum of 87 octane.
- For high altitude use, see Operation at High Altitude.
- Gasoline with no more than 10% ethanol is acceptable.



OPERATION

NOTICE Do not mix oil in gasoline or modify engine to run on alternate fuels not described in this manual. Use of unapproved fuels could damage engine and will not be covered under warranty.

1. Clean area around fuel fill cap, remove cap.
2. Slowly add unleaded fuel to fuel tank. Be careful not to fill above the RED fuel level indicator. This allows adequate space for fuel expansion.

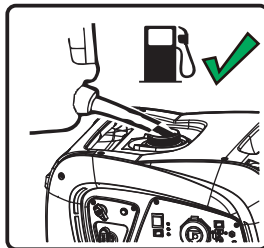
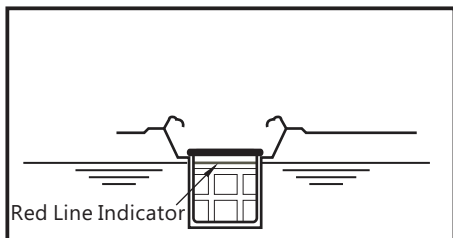

3. Install fuel cap and let any spilled fuel evaporate before starting engine.

Operation at High Altitude

At altitudes over 5,000 feet(1524 meters), a minimum 85 octane gasoline is acceptable. Engine power and generator output will be reduced approximately 3.5% for every 1000 feet (305 m) of elevation above sea level. High altitude may cause hard starting, increased fuel consumption and sparkplug fouling. To operate at high altitudes FIRMAN can provide a high altitude carburetor main jet. The alternative main jet and installation instructions can be obtained by contacting Customer Support.

	193cc	Altitude
Altitude main jet 1	333717004	3000-6000Feet
Altitude main jet 2	333717005	6000-8000Feet

NOTICE Operation using an alternative main jet at elevations lower than the recommended minimum altitude can damage the engine. For operation at lower elevations, the standard main jet supplied must be used. Operating the engine with the wrong main jet may increase exhaust emissions, fuel consumption and reduce performance.

Operation at High Ambient conditions

Your Firman Power Equipment product is designed and rated for continuous operation at ambient temperatures up to 104°F (40°C). The generator may be operated at temperatures ranging from 5°F(-15°C) to 122°F(50°C) for short periods. If the generator is exposed to temperatures outside this range during storage, the generator should be brought back within this range before operation. When operated above 77°F(25°C) there may be a decrease in power. Maximum wattage and current are subject to and limited by such factors as ambient temperature, altitude, engine conditions etc.

Connecting LPG Fuel



WARNING! Liquid Petroleum gas (LPG) is extremely flammable which could cause burns or fire resulting in death or serious injury.

- The fuel supply line must always be shut off when the engine is not running. Failure to shut off fuel may allow fuel to leak at the generator.
- Do not place the LPG sources in the path of muffler outlet or near any ignition source.
- Keep a fire extinguisher near the generator all the time.
- Do not use or store LPG portable sources not in use near generator or in a building, garage or enclosed area.
- All LPG supply/ piping lines must be installed by a qualified plumber.
- If you smell gas, close off all gas sources and contact a qualified plumber to inspect and repair the LPG .
- Prior to each days first use spray a soapy water solution on LPG fuel connections to check for leaks.
- Never use a gas container, LPG connector hose or LPG cylinder that appears to be damaged.
- Do not connect or disconnect the LPG source in an enclosed area.
- LPG is heavier than air and can accumulate in confined / low spaces if there is a leak.

NOTICE If a fuel supply connection is necessary it must be installed in accordance with all local codes or regulations, or in the absence of local codes or regulations, in accordance with the National Fuel Gas Code (NFPA 54/ANSI Z223.1) and CSA B149.1 (Natural Gas and Propane Installation Code), as applicable. If possible the fuel supply connection should be close to the outdoor operating location. This will reduce the cost of the flexible fuel run. An approved flexible fuel line must be installed between the generator LPG Hose Connector (Inlet) and the fuel supply connection. In no case should this information be interpreted to conflict with any local, state, or national code. If in doubt, always follow local codes.

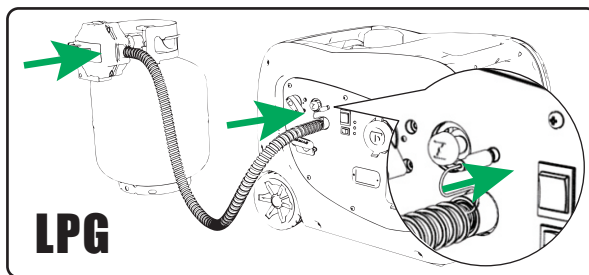

- Always keep the LPG cylinder in an upright position.
- Use only DOT LPG cylinders in vapor service with type 1, right hand ACME threads. Verify the re-qualification date on the cylinder has not expired.
- All new cylinders must be purged of air and moisture prior to filling. The purging process should be done by your propane gas supplier.

Attach the LPG regulator hose assembly (included) to the LPG hose connector (inlet) on the control panel of the generator. Tighten the nut with a 19 mm or adjustable wrench. Remove the safety plug or cap from the LPG cylinder valve. Attach the LPG regulator to the cylinder valve. Do not use a wrench to tighten LPG cylinder nut. Tighten the nut by hand clockwise to a positive stop. Using a wrench may damage LPG cylinder components.

OPERATION

3.Starting the Generator on Gasoline

1. Before starting the generator, check for loose or missing parts and for any damage which may have occurred during shipment. Ensure spark plug, muffler, fuel cap, and air cleaner are all in place.
2. Move portable generator outdoors to safe operating location at least 20 feet from any occupied spaces.
- 3.If connected make sure the LPG cylinder knob is fully closed or disconnected.



4. Disconnect all electrical loads from the generator. Never start or stop the generator with electrical devices plugged in.

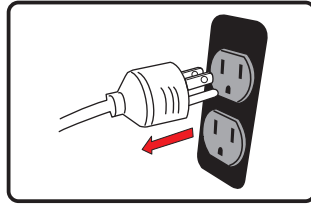

5. Turn the main fuel selector switch to “GAS” position(4:30 o’clock).



6. Flip the engine switch to the “RUN”(I) position.

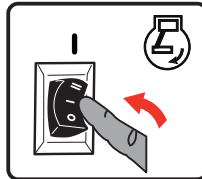

7. Push the battery power restore switch for about 3 seconds and then release.

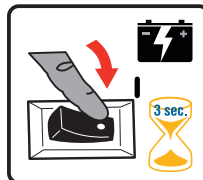

8. Pull the choke knob out to the “**START**” position. You do not need to choke a warm engine.
(For electric start move to step (10))

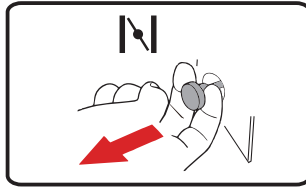

9. For recoil start only-Pull the starter cord slowly until resistance is felt and then pull rapidly to start engine.

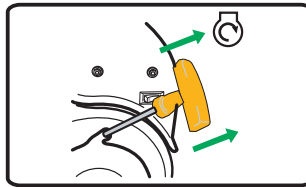

10. For electric start only-Flip the engine switch to the START (II) position for a few seconds and then release.

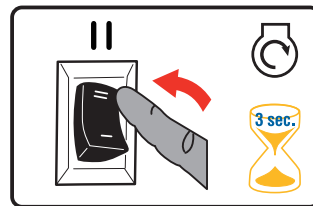

11. Do not over-choke. As soon as engine starts and warms up, move the choke knob to the “**RUN**” position.

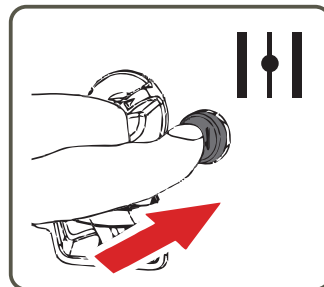

12. Allow portable generator to run at no load for a few minutes to stabilize before plugging in any electrical devices.

NOTICE If engine starts but fails to run, or if portable generator shuts down during operation, check oil level. See Low Oil Shutdown section for more information.

The gasoline valve is OPEN, when the fuel selector switch is in “**GAS**” position (4:30 o'clock).
To close this valve, turn the selector switch to the “**LPG**” position (1:30 o'clock).

OPERATION

4. Starting the Generator on LPG

1. Before starting the generator, check for loose or missing parts and for any damage which may have occurred during shipment. Ensure spark plug, muffler, fuel cap, and air cleaner are all in place.
2. Move portable generator outdoors to safe operating location at least 20 feet(6 m) from any occupied spaces.
3. Connect the LPG hose with regulator to both LPG cylinder and portable generator LPG Hose Connector (inlet).

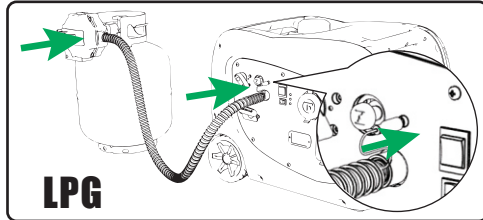

4. Fully open the LPG cylinder knob.

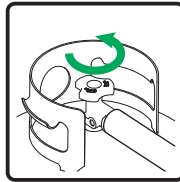

5. Disconnect all electrical loads from the generator. Never start or stop the generator with electrical devices plugged in.

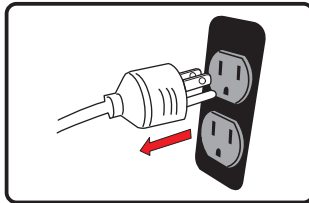

6. Turn the main fuel selector switch to LPG position(1:30 o'clock).

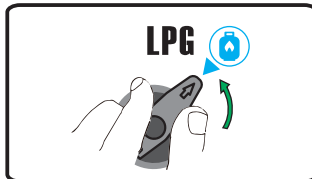

7. Flip the engine switch to the "RUN" (I) position.

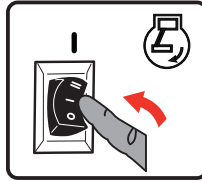

8. Push the battery power restore switch for about 3 seconds and then release.

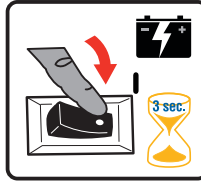

9. Pull the choke knob out to the "START" position.(For electric start move to step (13))

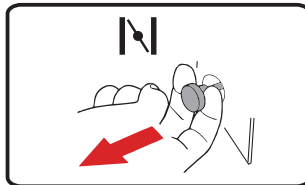

10. For recoil start only - PULL-TO-PRIME Pull the starter cord 1-2 times. Pull slowly until resistance is felt and then pull rapidly.

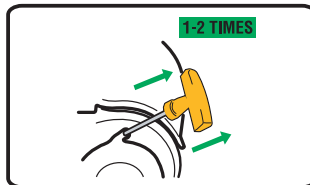

11. For recoil start only - Move the choke knob to the "RUN" position.

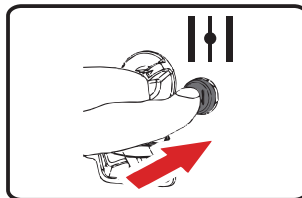

OPERATION

12. For recoil start only - PULL-TO-RUN Pull the starter cord slowly until resistance is felt and pull rapidly to run the portable generator.

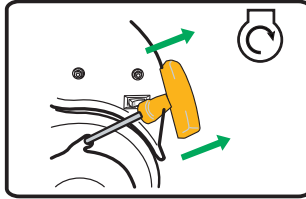

If the engine fails to start in 1-2 pulls with choke in the RUN position, move choke knob to START position and repeat the PULL-TO-PRIME step (10).

13. For electric start only-Flip the engine switch to the START (II) position for a few seconds and then release.

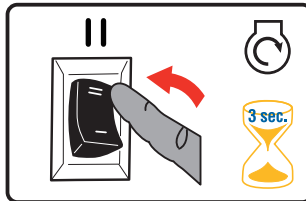

14. For electric start only - Move the choke knob to the RUN position.

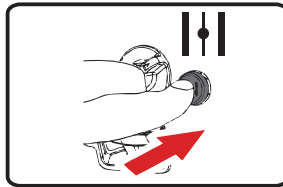

15. Allow portable generator to run at no load for a few minutes to stabilize before plugging in any electrical devices.

NOTICE If engine starts but fails to run, or if portable generator shuts down during operation, check oil level. See Low Oil Shutdown section for more information.

NOTICE Observing frost on LPG cylinder and regulator is common during operation and normally is not an indication of a problem. In unusual situations this frost may eventually restrict the flow of LPG gas to the generator resulting in deteriorating performance. In these rare situations it can be helpful to:

- Exchanging fuel cylinders to allow the first cylinder to warm up, repeating as necessary.
- Placing the LPG cylinder at the end of the generator near the handle, where engine fan air flows out from the generator. This air is slightly heated by air flowing over the engine. Do not place the LPG cylinder in the path of the muffler exhaust outlet.
- The LPG cylinder and components can be temporarily warmed by pouring warm water over them.

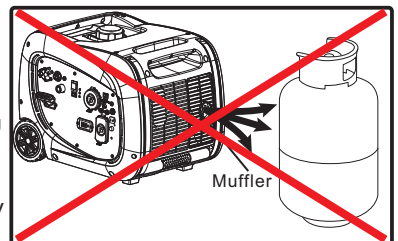

5. Connecting Electrical Loads

This inverter generator has been pretested and adjusted to handle its full capacity.



WARNING! Generator voltage could cause electrical shock or burn resulting in death or serious injury.

- Damaged or overloaded extension cords could overheat, arc, and burn resulting death or serious injury.
 - Use a ground fault circuit interrupter (GFCI) in any damp or highly conductive area, such as metal decking.
 - Do not touch bare wires or receptacles.
 - Do not use generator with electrical cords which are worn, frayed, bare or otherwise damaged.
 - Do not operate generator in the rain or wet weather.
 - Do not run indoors to avoid wet conditions.
 - Do not handle generator or electrical cords while standing in water, while barefoot, or while hands or feet are wet.
1. Ensure circuit breaker on control panel is in the closed (on) position.
 2. Start the generator with no electrical load attached.
 3. Allow the engine to run for several minutes to stabilize.
 4. Plug in and turn on the first item. It is best to attach the item with the largest load first.
 5. Allow the engine to stabilize.
 6. Plug in and turn on the next item.
 7. Allow the engine to stabilize.
 8. Repeat steps 5-6 for each additional item.

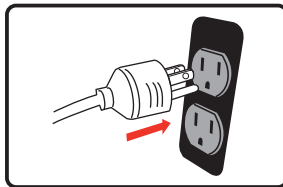

Surge Protection

There is a remote chance that voltage fluctuations may impair the proper functioning of some sensitive electronic equipment. Electronic devices, including computers and many programmable appliances may use components that are designed to operate within a narrow voltage range and may be affected by the portable generator's momentary voltage fluctuations. While there is no way to prevent all voltage fluctuations, you can take steps to protect your sensitive electronic equipment. Install a plug-in surge suppressor on the receptacles feeding your sensitive equipment. Surge suppressors come in single or multi-outlet styles. They are designed to protect against short duration voltage fluctuations.

OPERATION

CO Alert™

Carbon Monoxide (CO) Shutdown System

CO Alert automatically shuts down the engine when harmful levels of carbon monoxide accumulate around the generator or a CO Alert fault occurs. After shutdown, the CO Alert indicator light will blink for at least five minutes per the chart below.

CO Alert DOES NOT replace carbon monoxide alarms.

Install battery-powered carbon monoxide alarm(s) in your home. Don't run generator in enclosed areas.

Color	Description
Red •••••	Carbon monoxide accumulated around generator. Prior to restart move generator to an open, outdoor area 20 ft. (6 m) from occupied spaces with exhaust pointed away. Air out premises (open windows and doors) before reoccupying property. Automatic shutoff is an indication generator was improperly located. If you start to feel sick, dizzy, weak, or your homes carbon monoxide alarm sounds while using this product, get to fresh air right away. Call emergency services. You may have carbon monoxide poisoning.
Yellow •• ••	CO Alert fault occurred*. See FIRMAN authorized service dealer.

*Yellow light will blink for five seconds at the startup of generator to show CO ALERT is functioning properly.

Economy Control Switch

The Economy Control switch can be activated in order to minimize fuel consumption and noise while operating the unit during times of reduced electrical output, allowing the engine speed to idle during periods of non-use. The engine speed returns to normal when an electrical load is connected. When the economy switch is off, the engine runs at normal speed continuously.

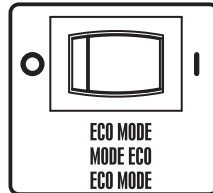

NOTICE:

For periods of high electrical load or momentary fluctuations, the Economy Control Switch should be turned OFF.

12V DC Outlet (Battery Charger)

The 12V DC outlet is **ONLY** to be used with the supplied 12V battery charging cable. The DC output is unregulated and will damage other 12V DC products.

The amount of current flowing will depend on the charging voltage and battery's state of charge. As the battery becomes more fully charged, the output current to the battery decreases and nearly becomes constant. Taper chargers are intended to be used with the provision that they will be disconnected from the battery after a maximum time on charge. Normally a period of 30 to 120 minutes is sufficient to recharge a weak battery. The charge level of the battery should be checked periodically.

NOTICE

- For use with 12V direct current outlet, always keep the ECO mode deactivated (OFF Position).
- You can use the 12V direct current outlet and the 230V current at the same time, but keep the ECO mode deactivated (OFF Position) at all times.

Do not start the vehicle while the battery charging Cable is connected and the generator is running. It will not give the battery a boost of power. The Vehicle or the generator may be damaged. Charge only vented wet lead acid batteries. Other types of batteries may burst, causing personal injury or damage.

WARNING!

- Storage batteries give off **EXPLOSIVE** hydrogen gas while charging. Do not allow smoking, open flames, sparks, or spark producing equipment in the area while charging.
- Battery electrolyte fluid is comprised of sulfuric acid that can be very dangerous and cause severe burns. Do not allow this fluid to contact eyes, skin, clothing, etc. If contact or spillage does occur, flush the area with water immediately.
- Do not continue to charge a battery that becomes hot or is fully charged.

1. Before connecting the battery charging cable to a battery that is installed in a vehicle, disconnect the vehicle battery ground cable from the negative (-) battery terminal.
2. Plug the battery charging cable into the DC receptacle of the generator.
3. Connect the red (+) battery charger lead to the red (+) battery terminal.
4. Connect the black (-) battery charger lead to the black (-) battery terminal.
5. Start the generator.

6. Stopping the generator

1. Turn off and remove all electrical loads.

Never stop the generator with electrical devices plugged in and turned on.

Never stop the engine by moving the choke to the start position.

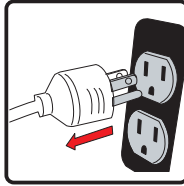

Let the generator run at no-load for one minute to stabilize internal temperatures of the engine and generator.

2. Flip the engine switch to "OFF" (O) position.

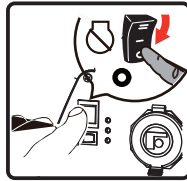

3. Turn the main fuel selector switch to "LPG" position (1:30 o'clock). The gasoline valve is closed in this position.

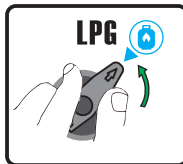

4. Fully close the LPG cylinder knob.



If a cover is used, do not install until unit has cooled.

NOTICE Disconnect the LPG cylinder from the generator during transportation.

Low Oil Shutdown

If the engine oil drops below a preset level, an oil switch will stop the engine. Check oil level with dipstick.

If oil level is between the **LOW** and **HIGH** mark on dipstick:

1. DO NOT try to restart the engine.
2. Contact an Authorized FIRMAN Service Dealer.
3. DO NOT operate engine until oil level is corrected.

If oil level is below the **LOW** mark on dipstick:

1. Add oil to bring level to **HIGH** mark.
2. Restart engine and if the engine stops again a low oil condition may still exist. DO NOT try to restart the engine.
3. Contact an Authorized FIRMAN Service Dealer.
4. DO NOT operate engine until oil level is corrected.

Do Not Overload Generator

Overloading a generator in excess of its rated wattage capacity can result in damage to the generator and to connected electrical devices. To prolong the life of your generator and attached devices, follow these steps to add electrical load:

1. Start the generator with no electrical load attached.
2. Allow the engine to run for several minutes to stabilize.
3. Plug in and turn on the first item. It is best to attach the item with the largest load first.
4. Allow the engine to stabilize.
5. Plug in and turn on the next item.
6. Allow the engine to stabilize.
7. Repeat steps 5-6 for each additional item.

Overload Operation

The overload indicator light will blink when the load exceeds 3550W (approximately) and cut power to the receptacles in 30 seconds. If the load exceeds 3680W (approximately), the light will turn on and cut power to the receptacles in 2 seconds.

How to Correct

1. Disconnect any electrical devices, and then stop the engine.
2. Reduce the total wattage of connected electrical devices until it is within the generator's rated output.
3. Inspect the Air Inlet and Control Panel for any blockage. Remove blockage if found.
4. Restart Engine.

Parallel Operation

Any two FIRMAN inverter generators with parallel ports, including two FIRMAN inverters model WH03242 can be paralleled to increase the total available electrical power to 6000 Watts. A FIRMAN Parallel kit (not included) is required for parallel operation. For Kit availability, call customer Service at 1-844-347-6261 or visit: www.firmanpowerequipment.com.

Maintenance - Storage

MAINTENANCE SCHEDULE

ITEM	NOTES	Daily(Before operation)	Initial 25 hours	Every 50 hours	Every 100 hours (or annual)	Every 250 hours
Spark Plug	Check condition. Adjust gap and clean. Replace if necessary.				✓	
Engine Oil	Check oil level.	✓				
	Replace.		✓		✓	
Air Filter	Clean, replace if necessary.			✓		
Fuel	Clean fuel tank strainer. Replace if necessary.				✓	
Fuel Line	Check fuel hose for cracks or other damage. Replace if necessary.	✓				
LPG Regulator /Hose Assy.	Check for damage and leaks. Replace if necessary.	✓				
Exhaust System	Check for leakage. Retighten or replace gasket if necessary.	✓				
	Check spark arrester screen. Clean/Replace if necessary.				✓	
Engine	Check adjust valve clearance. *					✓
	Clean combustion chamber. *					✓
Fittings/ Fasteners	Check. Replace if necessary.				✓	

* To be performed by knowledgeable/experienced owner or by authorized service center.

General Recommendations

Regular maintenance will improve the performance and extend the life of the generator. See any authorized dealer for service.

The generator's warranty does not cover items that have been subjected to operator abuse or negligence. To receive full value from the warranty, the operator must maintain the generator as instructed in this manual.

Some adjustments will need to be made periodically to properly maintain your generator.

All service and adjustments should be made at least once each season. Follow the requirements in the maintenance schedule chart above.

NOTICE Once a year you should clean or replace the spark plug and replace the air filter. New spark plug and clean air filter assure proper fuel-air mixture and help your engine run at peak performance and last longer.

When Transporting Generator

Transport with fuel tank EMPTY or with fuel switch in OFF position.
Do not tip generator at an angle which causes fuel to spill.

ENGINE MAINTENANCE

To prevent accidental starting, remove and ground spark plug wire before performing any service.

Change Engine Oil

Change engine oil every 100 hours. (for a new engine, change oil after 25 hours.)

If you are using your generator under extremely dirty or dusty conditions, or in extremely hot weather change the oil more often.

CAUTION! Avoid prolonged or repeated skin contact with used motor oil. Used motor oil has been shown to cause skin cancer in certain laboratory animals. Thoroughly wash exposed areas with soap and water.



KEEP OUT OF REACH OF CHILDREN. DON'T POLLUTE. CONSERVE RESOURCES. RETURN USED OIL TO COLLECTION CENTERS.

(a) Loosen the cover screws and remove the maintenance cover.



(b) Pop up the rubber plug from below yellow draining bolt.

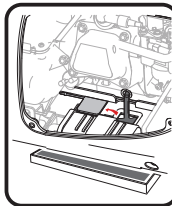

(c) Remove yellow drain bolt.

(d) Tilt the generator on its side and allow the oil to drain completely.

(e) Replace yellow drain bolt.

(f) Fill the engine with oil until it reaches the HIGH(H) level on the oil filler cap. DO NOT OVERFILL.

NOTICE We recommend using FIRMAN SAE 10W-30 API SJ oil for best performance. Other high-quality detergent oils (API SJ or higher) are acceptable. See *Oil and Gasoline / LPG*.

Maintenance - Storage

Air Filter Maintenance

(a) Remove the air cleaner cover and locate the air filter plastic cover.

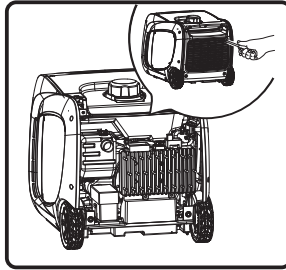

(b) Carefully remove foam air filter element and wash it with liquid detergent and water only. Squeeze dry in a clean cloth.

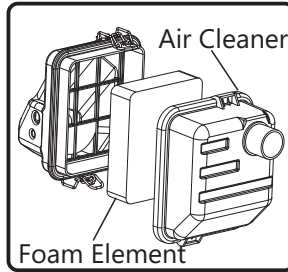

(c) Saturate foam air filter element with clean engine oil and squeeze in a clean cloth to remove excess oil.

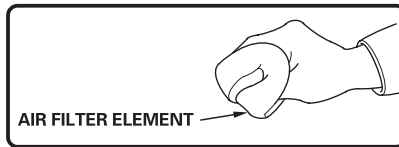

(d) Reinstall clean or new air filter element.

(e) Reattach the air filter cover.

(f) Reinstall the air cleaner cover and tighten the cover screw securely.

Spark Plug Maintenance

Changing the spark plug will help your engine start easier and run at peak performance.

(a) Remove the maintenance cover.

(b) Remove the spark plug boot.

(c) Remove spark plug using provided wrench.

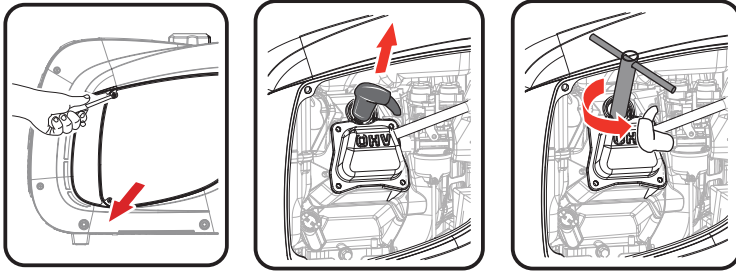

(d) Inspect spark plug for damage and clean with a wire brush before reinstalling. Replace if damaged.

(e) For spark plug FIRMAN P/N 330723001 - Adjust the electrode gap to 0.020 - 0.024 in. (0.5 - 0.6 mm).

(f) Seat spark plug in position and thread by hand to prevent cross threading.

(g) Tighten plug with provided wrench and put the spark plug boot back on spark plug.

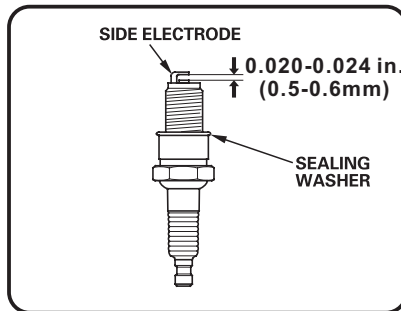

SPARK PLUG: FIRMAN P/N 330723001

SPARK PLUG: FIRMAN P/N 330723001

Maintenance Valve Clearance

Intake: 0.004 - 0.006 in. (0.10 - 0.15 mm)

Exhaust: 0.004 - 0.006 in. (0.10 - 0.15 mm)

Muffler and Spark Arrester



WARNING! Contact with muffler area could cause burns resulting in serious injury.

- Do not touch hot parts.
- It is a violation of California Public Resource Code, Section 4442, to use or operate the engine on any forest-covered, brush-covered, or grass-covered land unless the exhaust system is equipped with a spark arrester, as defined in Section 4442, maintained in effective working order. Other states or federal jurisdictions may have similar laws, reference Federal Regulation 36 CFR Part 261.52.

Maintenance - Storage

Inspect Muffler and Spark Arrester

1. Inspect the muffler for cracks, corrosion, or other damage.
2. Loosen the spark arrester clamp, remove the spark arrester cover, and remove the spark arrester with a thin blade screwdriver .

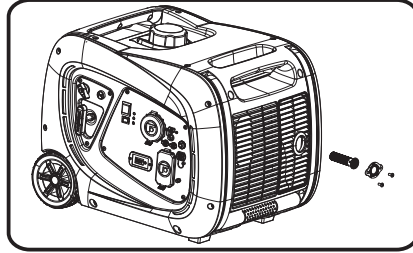

3. Carefully remove the carbon deposits from the spark arrester screen with a wire brush.

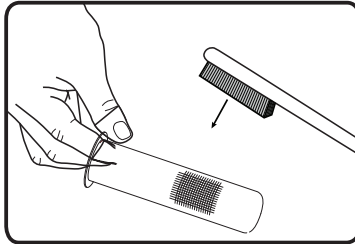

4. Replace the spark arrester if it is damaged. If replacement parts are required, make sure to use only FIRMAN original equipment replacement parts.
 5. Position the spark arrester in the muffler and attach spark arrester cover with the screws.
- NOTICE** Failure to clean or replace spark arrester may result in decreased engine performance.

GENERATOR MAINTENANCE

Run the generator at least 30 minutes every month.

Make certain that the portable generator is kept clean and dry.

Do not expose the unit to excessive dust, dirt, moisture or corrosive vapors.

Do not insert any objects through cooling slots.

Before each use inspect underneath the generator for signs of oil or fuel. Clean any accumulated debris. Keep area around muffler free from any debris. Use a soft bristle brush to remove dirt or caked on oil. Use a damp cloth to clean all exterior surfaces.

Battery Replacement

1. Unscrew the air cleaner cover by provided screwdriver.

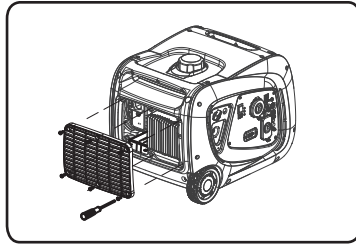

2. Release the battery retaining rubber belt.
3. Remove the protective cover(rubber sheath) from battery.
4. Disconnect the black(-) cable from black(-) terminal on the battery.
Disconnect the red(+) cable from red(+) terminal on the battery.

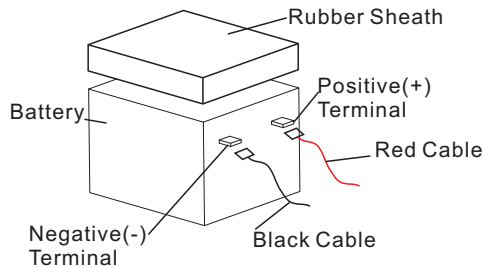

5. Remove the battery and recycle and dispose of properly.
6. Install the new battery with following specification:
12V sealed lead acid 5.5AH
LXWXH:3.54X2.76X3.84 in. (90X70X100mm)
7. Connect the red(+)battery cable to the positive terminal of battery first and then connect the black(-) battery cable to the negative terminal of battery.
8. Reattach the air cleaner cover.

Battery Charging

The battery powers the starter motor and control module. This portable generator is equipped with an automatic battery charging circuit. The battery will receive charging voltage only when the engine is running. The battery will maintain a proper charge if the portable generator is used on a regular basis (about once every two weeks). If it is used less frequently, we can use the supplied charger plugged into the generator 12V DC Battery Charge Port to charge the battery.

1. Plug the cord from the charger into the charging port on the generator control panel.
2. Plug the charger into a 120 volt AC wall outlet.
3. There is a light on the charger that remains red until the battery is fully charged at which point the light will turn green.

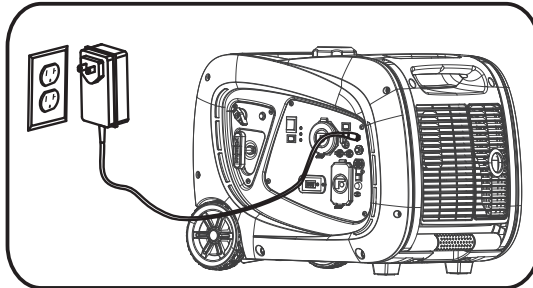

Long Term Storage

It is important to prevent gum deposits from forming in essential fuel system components such as the carburetor, fuel hoses or tank during storage. Ethanol-blended fuels (called gasohol, ethanol or methanol) attract moisture, which leads to separation and formation of acids during storage. Acidic gas can damage the fuel system of an engine while in storage.

When the generator set is being stored for more than one month, follow these instructions to avoid engine problems:



WARNING! Fuel and its vapors are extremely flammable which could cause burns or fire resulting in death or serious injury.

Do not store fuel near any ignition sources.

When draining fuel move generator outdoors and use a commercially available non-conductive vacuum siphon. Fuel must be drained into an approved container.

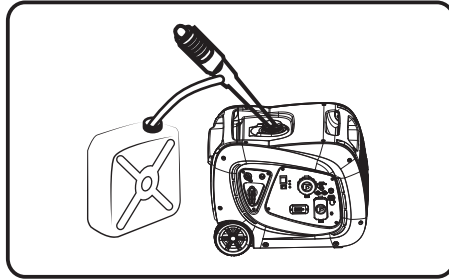

1-Treat any stored fuel with fuel stabilizer.

2-When storing generator with gasoline in fuel tank, operate the engine for 5-10 minutes to circulate treated fuel into fuel lines and carburetor before shutdown.

3- There is no need to drain gasoline from the generator fuel tank if fuel stabilizer is added.

4-FUEL STARVATION: If you elect to drain fuel tank move generator outdoors. Once fuel tank is drained turn fuel valve to on position. Start and run the portable generator outdoors until engine stops from lack of gasoline. This will drain remaining gasoline from tank, fuel lines, and carburetor.

5-Always turn fuel valve to OFF position prior to storage.

6-Allow the portable generator to cool before cleaning and storage.

7-Change oil .

8-Remove spark plug boot and spark plug. Pour about one teaspoon of engine oil through the spark plug hole, then slowly pull the recoil starter several times to distribute the oil in the cylinder. Pull recoil slowly until resistance is felt. This will close the valves so no moisture enters the engine cylinder. Reinstall the spark plug and attach the spark plug boot.

9-Cover the portable generator and store in a clean, dry place out of direct sunlight and away from any ignition sources.

Any damage or hazards caused by using improper fuel, improperly stored fuel, and/or improperly formulated stabilizers, are not covered by manufacturer's warranty.

Do not store gasoline from one season to another season.

Troubleshooting - Specifications

Problem	Cause	Correction
Engine is running, but no AC output is available.	<ol style="list-style-type: none"> 1. Circuit breaker is open. 2. Fault in generator. 3. Poor connection or defective cord set. 4. Connected device is bad. 5. Overload. 	<ol style="list-style-type: none"> 1. Reset circuit breaker. 2. Contact authorized service facility. 3. Check and repair. 4. Connect another device that is in good condition. 5. Shut off engine, reduce electrical load, and restart.
Engine runs good at no-load but "bogs down" when loads are connected.	<ol style="list-style-type: none"> 1. Short circuit in a connected load. 2. Engine speed is too slow. 3. Shorted generator circuit. 4. Clogged or dirty fuel filter. 	<ol style="list-style-type: none"> 1. Disconnect shorted electrical load. 2. Contact authorized service facility. 3. Contact authorized service facility. 4. Clean or replace fuel filter.
Engine will not start; starts and runs rough or shuts down when running.	<ol style="list-style-type: none"> 1. Fuel selector switch set to OFF (O) position. 2. Low oil level. 3. Dirty air cleaner. 4. Out of gasoline. 5. Stale gasoline. 6. Spark plug wire not connected to spark plug. 7. Bad spark plug. 8. Water in gasoline. 9. Flooded. 10. Excessively rich fuel mixture. 11. Clogged or dirty fuel filter. 12. Starting battery may have insufficient charge. 13. Out of LPG. 14. LPG cylinder knob is not open. 15. Out of battery power. 	<ol style="list-style-type: none"> 1. Set fuel selector switch to "GAS" or "LPG" position. 2. Fill crankcase to proper level or place generator on level surface. 3. Clean or replace air cleaner. 4. Fill fuel tank with gasoline. 5. Drain fuel tank and carburetor; fill with fresh gasoline. 6. Connect wire to spark plug. 7. Replace spark plug. 8. Drain gas tank and carburetor; fill with fresh gasoline. 9. Wait 5 minutes and re-crank engine. 10. Contact authorized service facility. 11. Clean or replace fuel filter. 12. Check battery output and charge battery as necessary. 13. Replace LPG cylinder. 14. Fully open LPG cylinder knob . 15. Charge the battery.
Engine lacks power.	<ol style="list-style-type: none"> 1. Load is too high. 2. Dirty air filter. 3. Clogged or dirty fuel filter. 4. Clogged spark arrester. 	<ol style="list-style-type: none"> 1. Don't Overload Generator 2. Replace air filter. 3. Clean or replace fuel filter. 4. Clean or replace spark arrester.
Engine "hunts" or falters.	<ol style="list-style-type: none"> 1. Carburetor is running too rich or too lean. 2. Clogged or dirty fuel filter. 	<ol style="list-style-type: none"> 1. Contact authorized service facility. 2. Clean or replace fuel filter.
Engine shuts down when running.	<ol style="list-style-type: none"> 1. Out of gasoline or LPG. 2. Dirty air cleaner. 3. Low oil level. 	<ol style="list-style-type: none"> 1. Fill fuel tank with gasoline or replace LPG cylinder . 2. Clean or replace air cleaner. 3. Fill crankcase to proper level or place generator on level surface.
Engine shuts down and yellow CO fault light blinking.	<ol style="list-style-type: none"> 1. CO system fault 	<ol style="list-style-type: none"> 1. Contact authorized FIRMAN service facility.

For all other issues, contact authorized dealer or Firman customer service.

SPECIFICATIONS

Model	WH03242		
Starting Watts	4000(GASOLINE)/3750(LPG)		
Running Watts*	3200(GASOLINE)/3000(LPG)		
Rated AC Voltage	120V		
Rated Frequency	60Hz		
Phase	Single		
Voltage Regulator	Digital		
Power Factor	1		
Total Harmonic Distortion(THD)	<3%		
Alternator Type	Magneto Inductor		
Engine	FIRMAN		
Engine Type	Single Cylinder, 4-Stroke OHV Air Cooled		
Displacement	193cc		
Low Oil Shutdown	Yes		
Ignition System	Breakless Ignition Type, Flywheel Magneto		
Starting System	Recoil/Electric		
Fuel	Unleaded Automotive Gasoline		
Capacity Fuel Tank	1.8 U.S. Gallons (6.8L)		
Lubricating Oil Capacity	20.3 oz (0.6L)		
Carburetor Type	Float		
Air Cleaner	Polyurethane Type		
P.T.O. Shaft Rotation	Counter Clockwise (Facing P.T.O.)		
Oil Type	See "Add Engine Oil" Section		
AC Grounding System	Neutral Floating		
LPG fuel consumption	No Load	Half Load	Full Load
	6.5ft ³ /hr(0.69L/hr) 16,351 BTU/h (4,792 W)	15.5ft ³ /hr(1.65L/hr) 39,113 BTU/h (11,463 W)	23.3ft ³ /hr(2.47L/hr) 58,576 BTU/h (17,167 W)

*Generator certified in accordance with CSA (Canadian Standards Association) standard C22.2No. 100-14, Motors and Generators and complies with PGMA (Portable Generator Manufacturers' Association) standard ANSI/PGMA G300-2018, Safety and Performance of Portable Generators.

PARTS DIAGRAM AND PART LIST

WH03242 PARTS DIAGRAM

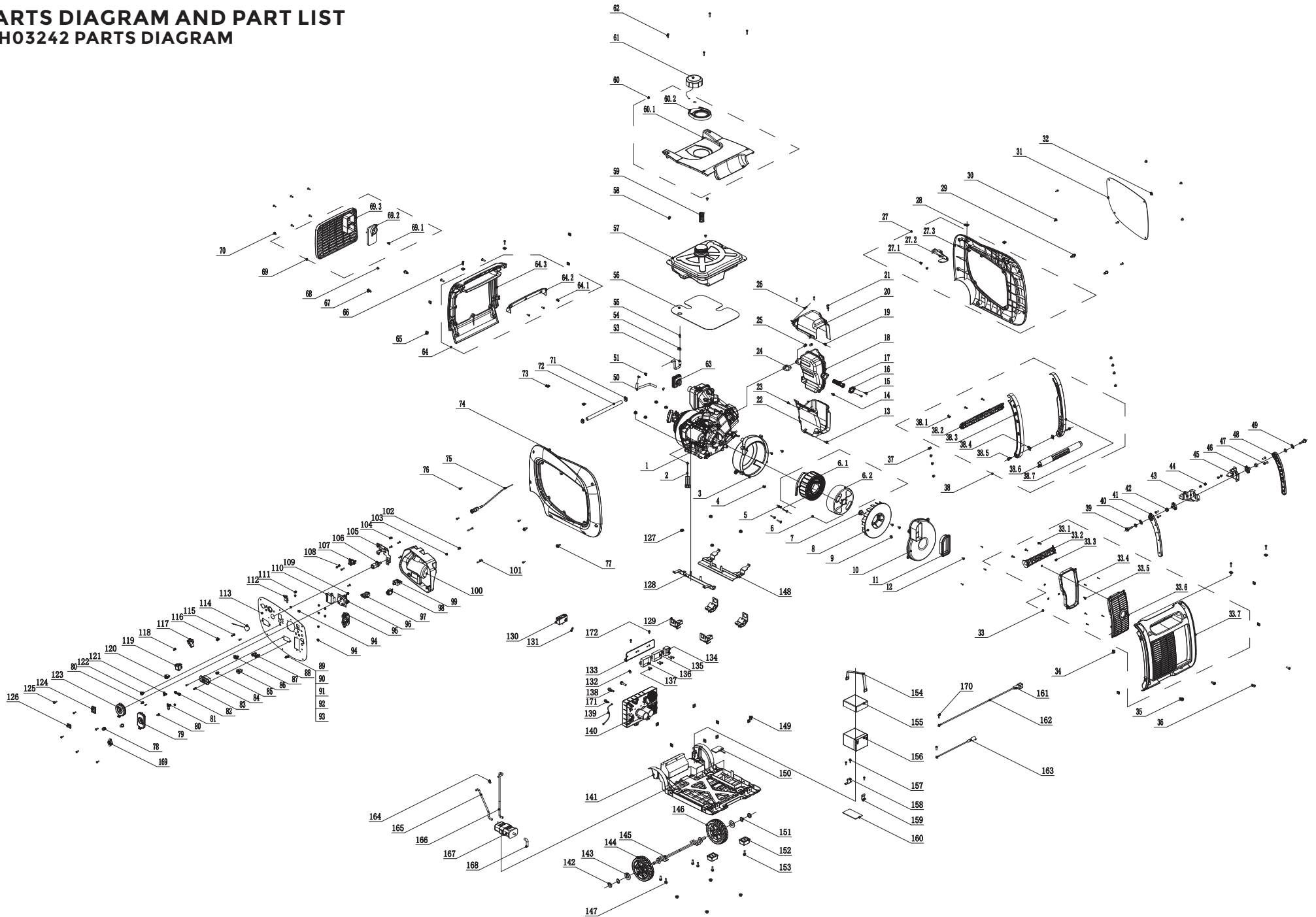

193cc ENGINE PARTS DIAGRAM

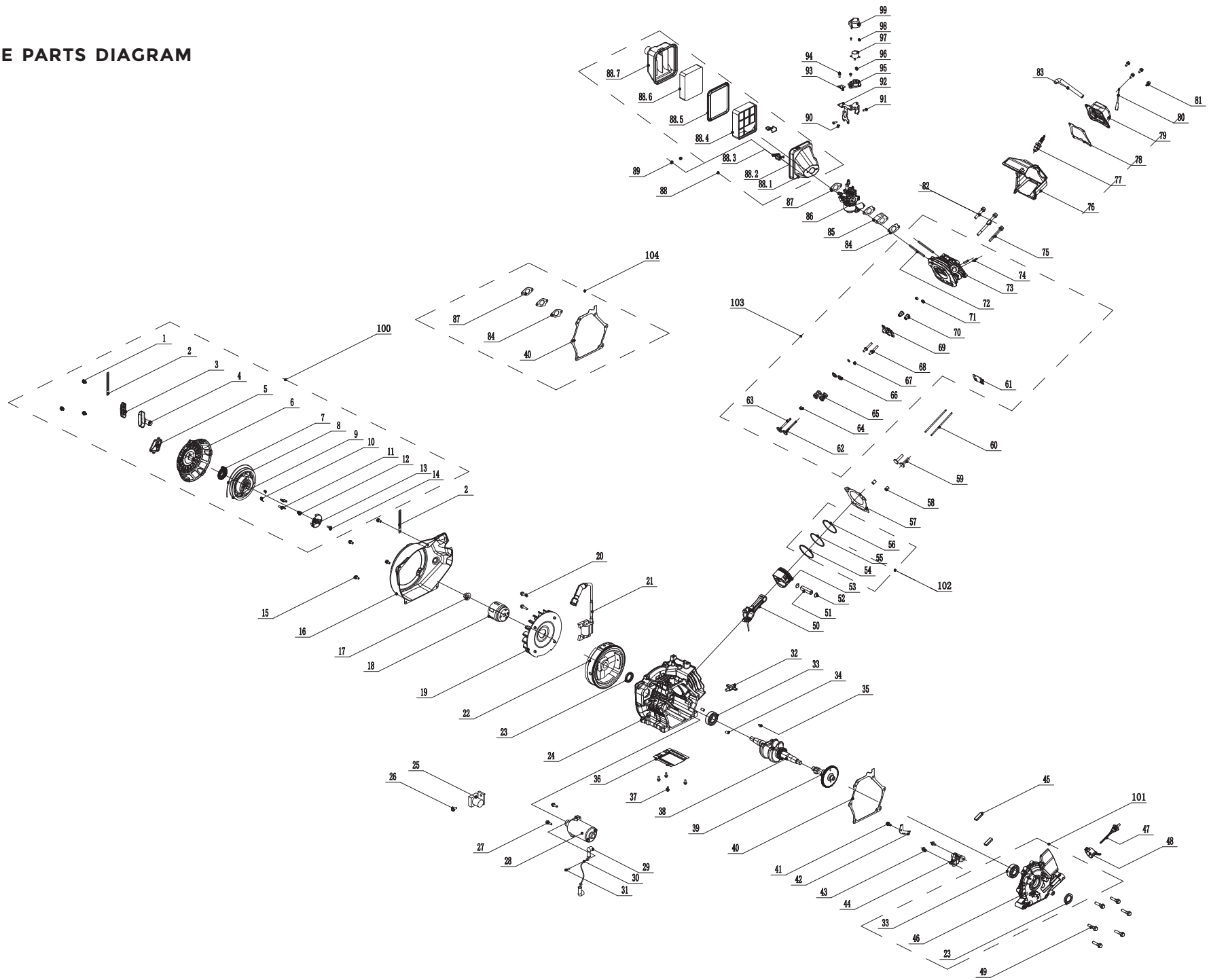

Parts Diagrams - Parts Lists - Wiring Diagram

WH03242 Portable Generator

NO.	Part Number	Description	Qty.	NO.	Part Number	Description	Qty.
1	332467001	Engine	1	38.1	336718362	Screw M5×14	3
2	333757001	Ground Wire	1	38.2	330713541	Handle,Lower	1
3	330713560	Generator End Cover	1	38.3	330713539	Handle,Left	1
4	317718304	Bolt M6×20	3	38.4	333717003	Nut M6	2
5	332717001	Bolt M6×45	4	38.5	336713561	Bolt M6×25	2
6	332457004	Alternator Assembly	1	38.6	330713540	Handle,Upper	1
6.1	332457005	Stator Assembly	1	38.7	330713528	Handle,Right	1
6.2	332457006	Rotor Assembly	1	39	330713529	Bolt M8×16	2
7	330713555	Nut M14	1	40	333717004	Washer	2
8	332727006	Generator Fan	1	41	330713538	Bracket,Left	1
9	336723526	Bolt M6×15	2	42	333717005	Washer	2
10	330713552	Generator End Cover	1	43	330713537	Supporter,Left	1
11	330713550	Rubber Sleeve, End Cover	1	44	336718360	Screw M6×12	4
12	317713521	Screw St4.8×17	4	45	330713536	Supporter,right	1
13	317713521	Screw St4.8×17	1	46	330713535	Pivot Bracket	2
14	336718301	Bolt M6×12	1	47	333717006	Bolt M6×12	4
15	336713538	Screw M5×14	2	48	330713532	Bracket,Right	1
16	330713519	Plate, Spark Arrester	1	49	333717007	Washer	2
17	336713536	Spark Arrester Assembly	1	50	333727003	Fuel Pipe	1
18	330713516	Muffler Assembly	1	51	330713508	Clip (ø10.5×b8)	3
19	336718359	Screw St4.2×9.5	1	53	333727004	Fuel Pipe	1
20	330713522	Muffler Protector Assembly,Upper	1	54	333717020	Clip(ø12×b8)	1
21	330713523	Screw St4.2×16	4	55	333717008	Strainer	1
22	330713515	Muffler Protector Assembly,Lower	1	56	333717009	Insulation Hot	1
23	330713523	Screw St4.2×16	1	57	330713506	Fuel Tank	1
24	330713514	Gasket, Exhaust	1	58	336718361	Screw M6×12	4
25	330713521	Nut M6	2	59	333427007	Fuel Filter Assembly	1
26	330713523	Screw St4.2×16	1	60	333427004	Top Cover	1
27	333427001	Rear Cover	1	60.1	330713503	Cover, Top	1
27.1	336718360	Screw M6×12	2	60.2	330713501	Spillway, Fuel Tank	1
27.2	330713567	Supporter, Handle Left	1	61	330713500	Fuel Tank Cap	1
27.3	330713524	Supporter, Rear Cover	1	62	336718364	Screw M5×20	4
28	330713525	Cage Nut M5	2	63	330728300	Air Cleaner Connector	1
29	330713527	Bolt M6×16	2	64	333427005	Cover, Left	1
30	336718362	Screw M5×14	4	64.1	336718362	Screw M5×14	3
31	330713526	Protector ,Rear Cover	1	64.2	330713566	Handle, Left Side	1
32	336718361	Screw M6×12	4	64.3	330713569	Cover, Left Side	1
33	333427002	Right Cover	1	65	330713525	Cage Nut M5	6
33.1	336718362	Screw M5×14	3	66	336718362	Screw M5×14	4
33.2	330713546	Handle, Right	1	67	330713527	Bolt M6×16	2
33.3	333717002	Spring Leaf	5	68	330723533	Screw M5×10	1
33.4	330713549	Rubber Seal Sleeve	1	69	333427006	Maintenance Window	1
33.5	336718359	Screw St4.2×9.5	6	69.1	330713570	Screw ST4.8×13	1
33.6	330713547	Cover, Right Muffler	1	69.2	330713571	Cover Plate, Left	1
33.7	330713545	Cover, Right Side	1	69.3	330713572	Maintenance Window	1
34	330713525	Cage Nut M5	6	70	336718362	Screw M5×14	6
35	330713527	Bolt M6×16	2	71	336713835	Metal Clamp (ø8-ø14)×b8	2
36	336718363	Screw M6×20	4	72	357713591	LPG hose	1
37	336718361	Screw M6×12	8	73	333713525	Cage Nut M5	2
38	333427003	Handle	1	74	330713653	Front Cover	1

Parts Diagrams - Parts Lists - Wiring Diagram

NO.	Part Number	Description	Qty.	NO.	Part Number	Description	Qty.
75	330713657	Pull Chock Assembly	1	125	333717013	Screw M5×14	6
76	336718362	Screw M5×14	4	126	336727009	Switch Cover	1
77	330713527	Bolt M6×16	2	127	336718315	Nut M8	12
78	336755005	Circuit Breaker Cover	2	128	330713564	Supporter,right	1
79	336713575	Receptacle Cover,5-20R Duplex	1	129	330713565	Motor Mount	4
80	333717010	Screw M3×10	1	130	392428300	CO Module	1
81	330713613	Receptacle Cover, USB	1	131	332717002	Washer	1
82	330713602	Receptacle Cover	2	132	332717007	Bushing	2
83	336718383	Screw M4×14	2	133	332717003	Stents,Fuel Valve	1
84	333457007	Table	1	134	330713574	Rectifier	1
85	330713618	Receptacle(Battery Charger)	1	135	330713651	Charger	1
86	330713608	Receptacle DC 12v	1	136	330713650	Control Module	1
87	330713629	Switch	1	137	330713582	Screw M4×14	5
88	330713603	Parallel Ports	2	138	336713561	Bolt M6×25	2
89	336718345	Bolt M5×16	1	139	332457008	Ground Wire	1
90	336713577	Nut M5	1	140	332457007	Inverter	1
91	333717011	Nut M5	1	141	330713588	Base Setting Component	1
92	336713579	Washer Ø5	2	142	330713583	Plug,Wheel	2
93	336713580	Washer Ø5	1	143	330713585	Washer Ø12	2
94	330713596	Nut M4	6	144	333727001	Wheel, Right	1
95	336713588	Receptacle 5-20R Duplex	1	145	330713587	Axle	1
96	336713584	Receptacle TT-30R	1	146	333727002	Wheel, Left	1
97	330713593	Receptacle USB	1	147	336718302	Bolt M6×12	4
98	330713614	D.C 10A Breaker,push Button	1	148	330713563	Supporter,Left	1
99	330713594	A.C 20A Breaker,push Button	1	149	333717014	Nut	8
100	330713592	Control Box	1	150	330713589	Plug	1
101	336713589	Screw M5×38	2	151	330713584	Retaing Ring Ø12	2
102	336713565	Screw M5×14	1	152	333717015	Rubber Mat	2
103	329713608	Washer Ø5	1	153	336718330	Bolt M6×20	2
104	333717012	Screw M5×12	4	154	330713623	Pinch,Rubbre	1
105	330713659	Stents, Fuel Valve	1	155	330713622	Sheath,Battery	1
106	330713655	Quick Coupler	1	156	332457009	Battery(5.5AH)	1
107	330713577	Fuel Valve	1	157	333717016	Screw M5×14	3
108	336718364	Screw M5×20	2	158	330713620	Stents I,battery	1
109	336713565	Screw M5×14	2	159	330713624	Stents II,battery	1
110	330713595	Speed Limiter	1	160	333427008	Cushion	1
111	333717013	Nut M3	5	161	357713571	Sheath,Connecter Black	1
112	336713822	Micro Switch	1	162	332457010	Battery Wire(red)	1
113	333457010	Control Panel	1	163	332457011	Battery Wire(black)	1
114	330713654	Lpg Inlet Cover	1	164	336713540	Clip (ø8×6)	1
115	336718383	Screw M4×14	2	165	330713636	Vapor Hose 2	1
116	330713660	Receptacle (Battery Charger)	1	166	330713635	Vapor Hose 1	1
117	330713656	Fuel Valve Knob	1	167	330713637	Carbon Canister	1
118	336718383	Screw M4×14	1	168	330713638	Vapor Hose 3	1
119	336713616	Lgnition Switch	1	169	332727005	Cover	1
120	330713599	Switch,economy	1	170	332717004	Screw M4×5	2
121	330713606	Receptacle Cover,DC 12V	1	171	330723533	Screw M5×10	1
122	336755002	Indicator Light	1	172	332717006	Screw M5×14	2
123	336713574	Receptacle Cover,TT-30R	1				
124	336755004	Engine Switch Cover	1				

Parts Diagrams - Parts Lists - Wiring Diagram

FIRMAN 193cc Engine

NO.	Part Number	Description	Qty.	NO.	Part Number	Description	Qty.
1	336713528	Bolt M6×8	3	57	330723611	Gasket, Cylinder Head	1
2	330723528	Wire Clip	2	58	330723548	Locating Pins	2
3	330723526	Rope Button	1	59	330723510	Lifter,Valve	2
4	330723525	Crip ,Starter	1	60	330723553	Push Rod	2
5	333467003	Guide Plate	1	61	330723552	Guide Plate,Push Rod	1
6	330723524	Reciol Starter Cover	1	62	330723547	Valve,Exhaust	1
7	330723523	Reciol Starter Spring	1	63	330723554	Valve,Intake	1
8	333467004	Pull Rope	1	64	330723550	Oil Seal,Valve	1
9	330723522	Reciol Starter Reel	1	65	330723559	Spring,Valve	2
10	330723521	Spring,Ratchet	2	66	330723560	Retainer,Valve Spring	2
11	330723520	Patchet,Starter	2	67	330723561	Valve Collet	2
12	330723519	Spring,Ratchet Guide	1	68	330723562	Bolt,Rocker Arm	2
13	330723518	Pawl Guide	1	69	330723563	Rocker Arm ,Valve	2
14	330723517	Screw,Pawl Guide	1	70	330723564	Adjusting Nut,Valve	2
15	336718301	Bolt M6×12	4	71	330723565	Lock Nut	2
16	330723516	Fan Cover	1	72	330723556	Stud Bolt(M6×97)	2
17	330723515	Nut M14	1	73	333467021	Cylinder Head	1
18	330723514	Pulley,Starter	1	74	330723555	Stud Bolt(M6×32)	2
19	330723513	Cooling Fan	1	75	330723551	Bolt M8×65	2
20	317718304	Bolt M6×20	2	76	330723566	Air Shroud,Cylinder	1
21	330723537	Ignition Coil	1	77	330723001	Spark Plug	1
22	330723616	Flywheel	1	78	333467006	Cylinder Head Cover Gasket	1
23	330723501	Oil Seal	2	79	330723568	Cylinder Head Cover Assembly	1
24	330723615	Crankcase	1	80	333467007	Battery Cable(-)	1
25	330723597	Relay,Starter	1	81	336718301	Bolt M6×12	4
26	336723526	Bolt M6×15	1	82	336713593	Bolt M8×45	2
27	317718304	Bolt M6×20	2	83	330723569	Breather Tube	1
28	330723596	Starter Motor	1	84	330723570	Gasket,Insulator	2
29	336713611	Sheath	2	85	330723571	Insulator,Carburetor	1
30	333467005	Connect Wire	1	86	333467008	Carburetor	1
31	330723533	Screw M5×10	1	87	330723573	Gasket, Air Cleaner	1
32	336723604	Bolt&Seal ring, Drain	1	88	333467009	Air Cleaner	1
33	330723506	Bearing 6205	2	88.1	330723574	Base,Air Cleaner	1
34	330723511	Locating Pins	2	88.2	333467010	Lock 2	2
35	330723509	Woodruff key(4×6.5×16)	1	88.3	333467011	Lock 1	2
36	330723534	Air Guide Board	1	88.4	330723576	Clapboard	1
37	330723533	Screw M5×10	4	88.5	330723577	Sealing Ring	1
38	330723508	Crankshaft	1	88.6	330723578	Element,Air Cleaner	1
39	330723532	Camshafe Comp	1	88.7	330723579	Cover,Air Cleaner	1
40	330723507	Gasket,Crankcase Cover	1	89	336713517	Nut M6	2
41	336718301	Bolt M6×12	1	90	336713546	Screw M5×10	1
42	330723505	Plate, Coil	1	91	357713569	Screw M5×10	2
43	336718301	Bolt M6×12	2	92	330723618	Support,Stepper Motor	1
44	330723503	Oil Level Sensor	1	93	330723585	Clamp Board,Choke Control Line	1
45	333467017	Sealing Strip	2	94	357713569	Screw M5×10	1
46	332467002	Cover,Crankcase	1	95	330723587	Stepper Motor Base	1
47	330723531	Oil Dipstick Assembly	1	96	330723588	Screw M4×8	2
48	330723530	Oil Nipple	1	97	330723589	Stepper Motor ,Throttle Valve	1
49	357713584	Bolt M8×35	6	98	380713542	Screw M3×6	2
50	330723539	Connecting Rod	1	99	330723591	Cover,Stepper Motor	1
51	330723606	Piston Pin	1	100	333467016	Starting Cover	1
52	330723540	Criclip	2	101	333467015	Lid Assembly	1
53	330723607	Piston	1	102	333467014	Piston Ring Assembly	1
54	330723608	Ring Coil	1	103	333467022	Cylinder Head Assembly	1
55	330723609	Ring ,Second Piston	1	104	333467012	Gasket Set	1
56	330723610	Ring ,First Piston	1				

Wiring Diagram

B	BLACK	Br	BROWN
Y	YELLOW	BW	BLACK WHITE
L	BLUE	WG	WHITE GREEN
G	GREEN	GY	GREEN YELLOW
R	RED	W	WHITE
O	ORANGE	YL	YELLOW BLUE
P	PINK	A	AMETHYST

ENGINE SWITCH	
1	2
3	4
5	6

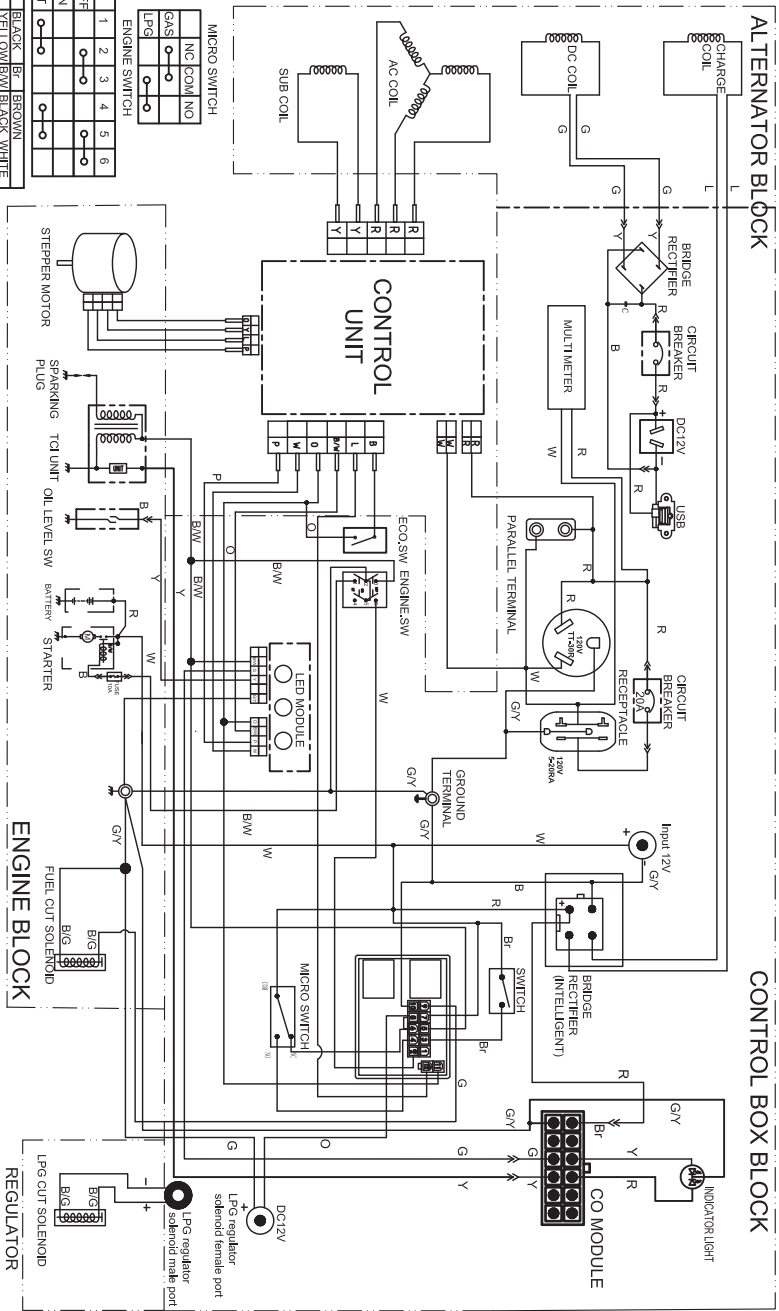

Service - Warranty

SERVICE INFORMATION CONTACT FIRMAN PRODUCT SERVICE DEPARTMENT AT 1-844-347-6261 or at www.firmanpowerequipment.com to obtain warranty service information or to order replacement parts or accessories.

HOW TO ORDER REPLACEMENT PARTS

Even quality-built equipment such as this electric generator may need occasional replacement parts to maintain it in good condition over the years. To order replacement parts, please give the following information:

- Model No. Rev. Level and Serial No. found on the Data Decal.
- Parts number or numbers as shown in the Parts List section.
- A brief description of the trouble with the generator.

FIRMAN 3 Years Limited Warranty

Warranty Qualifications

FIRMAN GENERATOR will register the warranty upon receipt of your Warranty Registration Card and a copy of your sales receipt from one of FIRMAN's retail locations as proof of purchase. Please submit your warranty registration and your proof of purchase within ten(10) days of the date of purchase.

Repair/Replacement Warranty

FIRMAN warrants to the original purchaser that the mechanical and electrical components will be free of defects in material and workmanship for a period of one(1) year(parts and labor) and 3 years (parts and technical support) from the original date of purchase 90 days [parts and labor] and 180 days [parts] for commercial & industrial use. Transportation charges on product submitted for repair or replacement under this warranty are the sole responsibility of the purchaser. This warranty only applies to the original purchaser and is not transferable.

Do Not Return the Unit to the Place of Purchase

Contact the FIRMAN Service Center and FIRMAN will troubleshoot any issue via phone or e-mail. If the problem is not corrected by this method, FIRMAN will, at its option, authorize evaluation, repair or replacement of the defective part or component at a FIRMAN Service Center. FIRMAN will provide you with a case number for warranty service. Please keep it for future reference. Repairs or replacements without prior authorization, or at an unauthorized repair facility, will not be covered by this warranty.

Warranty Exclusions

This warranty does not cover the following repairs and equipment.

Normal Wear

Your product needs periodic parts and service to perform well. This warranty does not cover repair when normal use has exhausted the life of a part or the equipment as a whole.

Installation, Use and Maintenance

This warranty will not apply to parts and/or labor if your product is deemed to have been misused, neglected, involved in an accident, abused, loaded beyond the generator's limits, modified, installed improperly or connected incorrectly to any electrical component. Normal maintenance is not covered by this warranty.

Other Exclusions

This warranty excludes:

- cosmetic defects such as paint, decals, etc.
- wear items
- accessory parts
- failures due to acts of God and other force majeure events beyond the manufacturer's control
- problems caused by parts that are not original FIRMAN parts
- units used for prime power in place of existing utility power where utility is present or in place of utility power where utility power service does not normally exist.

Limits of Implied Warranty and Consequential Damage

FIRMAN disclaims any obligation to cover any loss of time, use of this product, freight, or any incidental or consequential claim by anyone from using this product. THIS WARRANTY IS IN LIEU OF ALL OTHER WARRANTIES, EXPRESS OR IMPLIED, INCLUDING WARRANTIES OF MERCHANTABILITY OR FITNESS FOR A PARTICULAR PURPOSE.

A unit provided as an exchange will be subject to the warranty of the original unit. The length of the warranty governing the exchanged unit will remain calculated by reference to the purchase date of the original unit.

This warranty gives you certain legal rights which may change from state to state. Your state may also have other rights you may be entitled to that are not listed within this warranty.

Contact Information

You may contact FIRMAN at:

Address

Firman Power Equipment Inc.
Attn: Customer Service
8644 W. Ludlow Dr.
Peoria, AZ 85381
www.firmanpowerequipment.com

We are FIRMAN POWER - And we are here for you.

Service - Warranty

FIRMAN POWER EQUIPMENT INC. Emission Control System Warranty

CALIFORNIA AND FEDERAL EXHAUST AND EVAPORATIVE EMISSIONS CONTROL WARRANTY STATEMENT

YOUR WARRANTY RIGHTS AND OBLIGATIONS

The California Air Resources Board, US Environmental Protection Agency ("US EPA") and FIRMAN POWER EQUIPMENT INC. (FIRMAN) are pleased to explain the emissions control systems warranty on your 2022-2023 or later Small Off-Road Engine ("SORE") and engine powered equipment. In California, new equipment that use small off-road engines must be designed, built and equipped to meet the State's stringent anti-smog standards. FIRMAN must warrant the emissions control systems on your SORE and engine powered equipment for the periods of time listed below provided there has been no abuse, neglect or improper maintenance of your small off-road engine or equipment leading to the failure of the emissions control system. Your emissions control system may include parts such as the carburetor or fuel-injection system, the ignition system, catalytic converter, fuel tanks, fuel lines (for liquid fuel and fuel vapors), fuel caps, valves, canisters, filters, clamps and other associated components. Also included may be hoses, belts, connectors, and other emission-related assemblies.

Where a warrantable condition exists, FIRMAN will repair your SORE and engine powered equipment at no cost to you including diagnosis, parts and labor.

MANUFACTURER'S WARRANTY COVERAGE:

The exhaust and evaporative emissions control system on your small off-road engine and engine powered equipment is warranted for two years. If any emissions-related part on your small off-road engine and engine powered equipment is defective, the part will be repaired or replaced by FIRMAN.

OWNER'S WARRANTY RESPONSIBILITIES:

As the SORE and engine powered equipment owner, you are responsible for the performance of the required maintenance listed in your operator's manual. FIRMAN recommends that you retain all receipts covering maintenance on your SORE and engine powered equipment, but FIRMAN cannot deny warranty coverage solely for the lack of receipts or for your failure to ensure the performance of all scheduled maintenance.

As the SORE and engine powered equipment owner, you should however be aware that FIRMAN may deny you warranty coverage if your small off-road engine or engine powered equipment or a part has failed due to abuse, neglect, or improper maintenance or unapproved modifications.

You are responsible for presenting your small off-road engine and engine powered equipment to a FIRMAN distribution center or service center as soon as the problem exists. The warranty repairs shall be completed in a reasonable amount of time, not to exceed 30 days.

If you have any questions regarding your warranty rights and responsibilities, you should contact FIRMAN at 1-844-347-6261.

FIRMAN Emission Control Defects Warranty Provisions

The warranty period begins on the date the engine/equipment is delivered to an ultimate purchaser. FIRMAN warrants to the ultimate purchaser and each subsequent purchaser that the engine is:

Designed, built, and equipped so as to conform with all applicable regulations adopted by the Air Resources Board and US EPA; and Free from defects in materials and workmanship that cause the failure of a warranted part to be identical in all material respects to the part as described in the engine manufacturers application for certification.

The warranty on emissions-related parts is as follows:

- (1) Any warranted part that is not scheduled for replacement as required maintenance in the owner's manual supplied, is warranted for the warranty period stated above. If any such part fails during the period of warranty coverage, the part will be repaired or replaced by FIRMAN at no charge to the owner. Any such part repaired or replaced under the warranty will be warranted for the remaining warranty period.
- (2) Any warranted part that is scheduled only for regular inspection in the owner's manual supplied, is warranted for the warranty period stated above. Any such part repaired or replaced under warranty will be warranted for the remaining warranty period.
- (3) Any warranted part that is scheduled for replacement as required maintenance in the owner's manual supplied, is warranted for the period of time prior to the first scheduled replacement point for that part. If the part fails prior to the first scheduled replacement, the part will be repaired or replaced by FIRMAN at no charge to the owner. Any such part repaired or replaced under warranty will be warranted for the remainder of the period prior to the first scheduled replacement point for the part.
- (4) Repair or replacement of any warranted part under the warranty must be performed at no charge to the owner at a warranty station.
- (5) Notwithstanding the provisions of Subsection (4) above, warranty services or repairs must be provided by FIRMAN that are franchised to service the subject engines.
- (6) The owner must not be charged for diagnostic labor that leads to the determination that a warranted part is in fact defective, provided that such diagnostic work is performed at a warranty station.
- (7) FIRMAN is liable for damages to other engine components proximately caused by a failure under warranty of any warranted part.

(8) Throughout the emissions warranty period defined in Subsection (b)(2), FIRMAN will maintain a supply of warranted parts sufficient to meet the expected demand for such parts.

(9) Any replacement part may be used in the performance of any warranty maintenance or repairs and must be provided without charge to the owner. Such use will not reduce the warranty obligations of the manufacturer.

(10) Add-on or modified parts that are not exempted by the Air Resources Board may not be used. The use of any non-exempted add-on or modified parts by the ultimate purchaser will be grounds for disallowing a warranty claim.

The manufacturer will not be liable to warrant failures of warranted parts caused by the use of a non-exempted add-on or modified part.

PARTS COVERED BY WARRANTY

Listed below are the parts (if equipped) covered by the Federal and California Emission Control System Warranty.

1. Ignition system including: <ul style="list-style-type: none">- Spark plug- Ignition coil	4. Air induction system including: <ul style="list-style-type: none">- Intake pipe/manifold- Air cleaner
2. Fuel metering system: <ul style="list-style-type: none">- Fuel tank- Fuel cap- Fuel lines (for liquid fuel and fuel vapors) and related fittings/clamps- Fuel regulator, carburetor and internal parts.	5. Crankcase breather assembly including: <ul style="list-style-type: none">- Breather connection tube
3. Catalytic muffler assembly including: <ul style="list-style-type: none">- Exhaust manifold- Catalytic converter- Muffler gasket-pulse valve	6. Fuel tank evaporative emission control system including: <ul style="list-style-type: none">- Purge valves- Carbon canister- Vapor hoses and fitting/clamps

Limitations

This Emission Control System Warranty shall not cover any of the following:

- (a) Consequential damages such as loss of time, inconvenience, loss of use of the engine or equipment, etc.
- (b) Diagnosis and inspection fees that do not result in eligible warranty service being performed.

FIRMAN POWER EQUIPMENT INC.
www.firmanpowerequipment.com

FOLLOW US ON SOCIAL MEDIA

USE

#EVERYGENERATORTELLSASTORY™

FOR YOUR CHANCE TO WIN FIRMAN SWAG



**FIRMAN POWER EQUIPMENT INC.
8644 W. LUDLOW DR.
PEORIA, AZ 85381
1-844-347-6261
WWW.FIRMANPOWEREQUIPMENT.COM**

All rights reserved. Any reprinting or unauthorized use without the written permission is expressly prohibited.
P/N:332745482 Rev:03