



ANSI Z21.96-2014+CSA B11.6-2019

BougeRV

USER MANUAL

For Propane Portable Water Heater

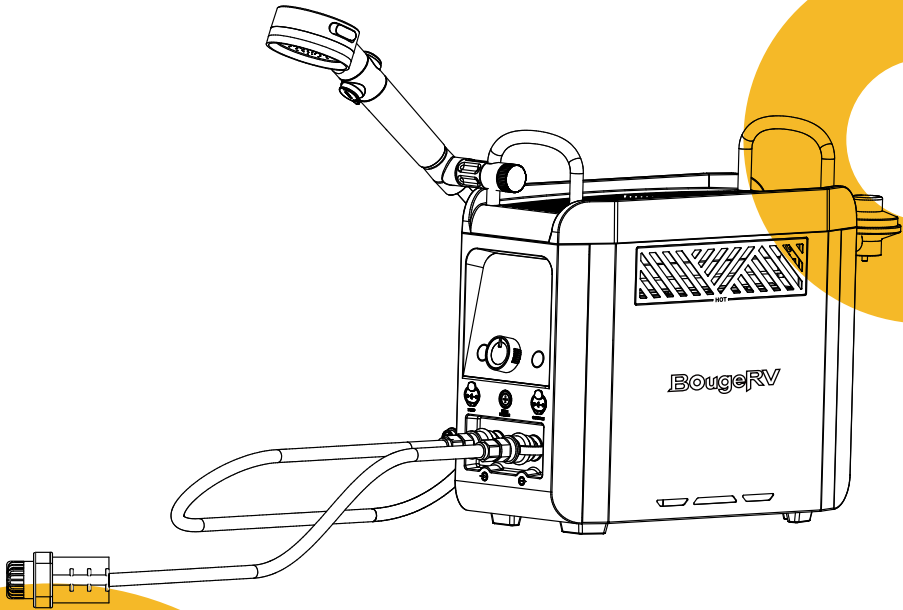

Please read this manual carefully before use and keep it properly for further reference.

Instructions for Use

-Outdoor use only-

- THIS APPLIANCE IS INTENDED FOR THE SUPPLY OF HEATED WATER FOR THE PURPOSE OF WASHING AND CLEANING ONLY.
- THIS APPLIANCE IS NOT INTENDED FOR THE SUPPLY OF DRINKING WATER.
- NOT FOR HOME OR RECREATIONAL VEHICLE USE.
- THE WATER HEATER IS FOR POINT OF USE, FOR TEMPORARY WATER HEATING AND NOT FOR CONNECTION TO A PERMANENT INLET WATER CONNECTION OR FOR CONNECTION TO A WATER DISTRIBUTION SYSTEM TO SUPPLY MULTIPLE OUTLETS.



Contents

1. Warning	-----Page 1
2. Specifications	-----Page 4
3. Product Overview	-----Page 5
4. Panel Introduction	-----Page 7
5. Operating Precautions	-----Page 7
6. Product Accessories	-----Page 8
7. Installation & Usage Tutorials	-----Page 8
8. Troubleshooting Guide	-----Page 11
9. Error Code Definition	-----Page 12
10. Circuit Diagram	-----Page 13
11. Warranty and Maintenance	-----Page 14

1. Warning

DANGER

■ CARBON MONOXIDE HAZARD

- When the water heater starts to heat water, propane inside may produce carbon monoxide during combustion.
- Using it in a confined space can cause death.
- Never use this appliance in a confined space such as a camper, tent car or home.
- This appliance should only be used in a naturally ventilated ground-level open-air environment where leaking gases and products of combustion can be dispersed by wind and natural convection.



■ EXPLOSION-FIRE HAZARD

- Never store propane near high heat, open flames, pilot lights, direct sunlight, or other ignition sources or where temperatures exceed 120° F (49° C)
- During operation, this product can be a source of ignition.
- Never use this appliance in spaces that contain or may contain volatile or airborne combustibles, or products such as gasoline, solvents, paint thinners, dust particles or unknown chemicals.

- Water temperatures over 125°F (52° C) can cause severe burns instantly or death from scalds. Children, the disabled, and the elderly are at the highest risk of being scalded. See the instruction manual before setting the temperature at the water heater. Feel water before bathing or showering.

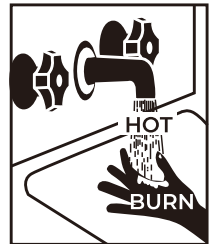

WARNING

■ YOUR SAFETY IS IMPORTANT, SO PLEASE READ THESE INSTRUCTIONS BEFORE OPERATION.

- This manual contains important information about the assembly, operation and maintenance of this appliance.
- Safety precautions are essential when any mechanical or propane fueled equipment is involved. These precautions are necessary when using, storing and servicing.

Following these safety alerts will reduce the possibility of personal Injury or property damage.

- Propane cylinders must be disconnected when this appliance is not being used or when storing this appliance.

Cylinders must be stored outdoors in a well-ventilated space and out of the reach of children.



WARNING

- Not for home or recreational vehicle use.
- The water heater is for point of use, for temporary water heating and not for connection to a permanent inlet water connection or for connection to a water distribution system to supply multiple outlets.
- Do not operate this appliance where flammable liquids or vapors may be present.
- Use the preset regulator that is installed. Do not attempt to adjust.
- It is forbidden to disassemble and repair the product, to use it as a cooker or to modify it for any other reason. DO NOT MODIFY THIS APPLIANCE.
- Never install or remove propane tank while this appliance is operating, near flame, other ignition sources or while this appliance is hot to the touch.



WARNING

- This appliance is not intended for the supply of drinking water. Drinking water heated by this appliance can cause health risks.
- This appliance is intended for the supply of heated water for the purpose of washing and cleaning only.
- Check and confirm safe water temperature before using this appliance. Water from this appliance may be very hot.



WARNING

If you smell gas:

1. Shut off gas to the appliance.
2. Extinguish any open flame.
3. If odor continues, keep away from the appliance and immediately call the fire department. Failure to follow these instructions could result in fire or explosion which could cause property damage, personal injury or death.



WARNING

1. Never store propane near high heat, open flames, pilot lights, direct sunlight, other ignition sources or where temperatures exceed 120 degrees F (49° C).
2. Propane is heavier than air and can accumulate in low places. If you smell gas, leave the area immediately.
3. Never install or remove propane tank while this appliance is operating, near flame, pilot lights, other ignition sources or while this appliance is hot to touch.
4. During operation, this appliance can be a source of ignition. Never ignite or use this appliance in spaces that contain or may contain volatile or air-borne combustibles, or products such as gasoline, solvents, paint thinner, dust particles or unknown chemicals. Minimum clearances from combustible materials: 12 inches (30.5 cm) from sides & 48 inches (122 cm) from the top.
5. Provide adequate clearances around air openings into the product. Do not obstruct the flow of combustion and ventilation air.

WARNING

1. Failure to comply with the precautions and instructions provided with this product can result in death, serious bodily injury and property loss or damage from hazards of fire, explosion, burn, asphyxiation, and/or carbon monoxide poisoning.
2. Only persons who understand and follow the instructions can use or service this product.
3. If you need assistance or information such as an instruction manual or labels, please contact BougeRV.

WARNING

1. Never leave heater unattended when hot or in use.
2. Do not touch metal parts and venting holes of the heater, which may get very hot when in use. Keep out of reach of children.
3. THIS APPLIANCE IS NOT INTENDED FOR THE SUPPLY OF DRINKING WATER.

WARNING

1. This product is fueled by propane gas. Propane gas is invisible, odorless, and flammable. An odorant is normally added to help detect leaks and can be described as a "rotten egg" smell. The odorant can fade over time so leaking gas is not always detectable by smell alone.
2. Propane gas is heavier than air and leaking propane will sink to the lowest level possible. It can ignite by ignition sources including matches, lighters, sparks or open flames of any kind many feet away from the original leak. Use only propane gas set up for vapor withdrawal.
3. Gas cylinders must be stored outdoors in a well ventilated area and out of the reach of children. Any indoor storage should comply with AS/NZS 1596.
4. Disconnect propane before storing this appliance.

WARNING

When using electrical products, basic precautions should always be practiced including the following:

1. READ AND FOLLOW ALL SAFETY INSTRUCTIONS.
2. Read and follow all instructions that are on the product or provided with the product.
3. For a cord-connected or direct plug-in power unit, do not use an extension cord.
4. Do not install or use within 10 feet (3 m) of a pool.
5. Do not use in a bathroom.

WARNING: Risk of Electric Shock. When used outdoors, install only to a covered Class A GFCI protected receptacle that is weatherproof with the power unit connected to the receptacle. If one is not provided, contact a qualified electrician for proper installation. Ensure that the power unit and cord do not interfere with completely closing the receptacle cover.

2. Specifications

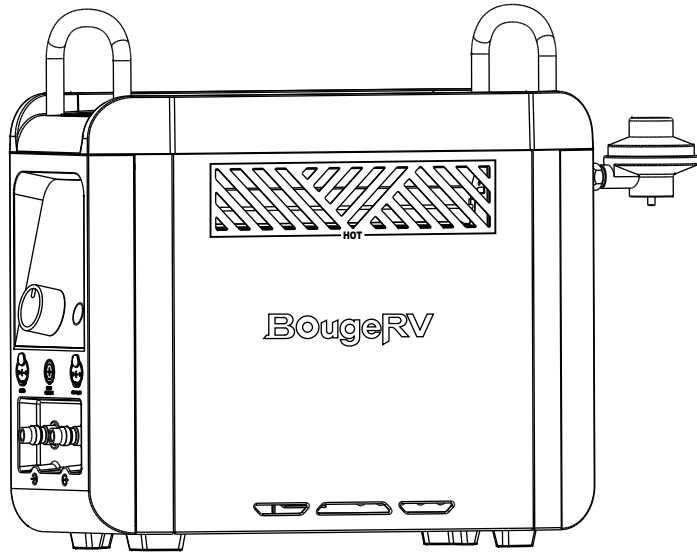

E0102-06001

Dimensions(LxDxH):	15.7X6.7 X12.2in
Electrical Input:	DC12V
Rating: BTU	10,000-20,500BTU
Water Yield: GPM	0.53-0.8GPM
Fuel Supply Pressure (to regulator):	Max Bottle Pressure
Weight(LBS):	13.7LBS
High Temperature Control:	122(°F)
Fuel Source:	Propane
Materials:	PA66+GF+UV
Battery:	18650battery pack(2500mAh)
Run Time (Full Charge):	65 minutes
Charging Time:	=1h (attain 80%)

3. Product Overview

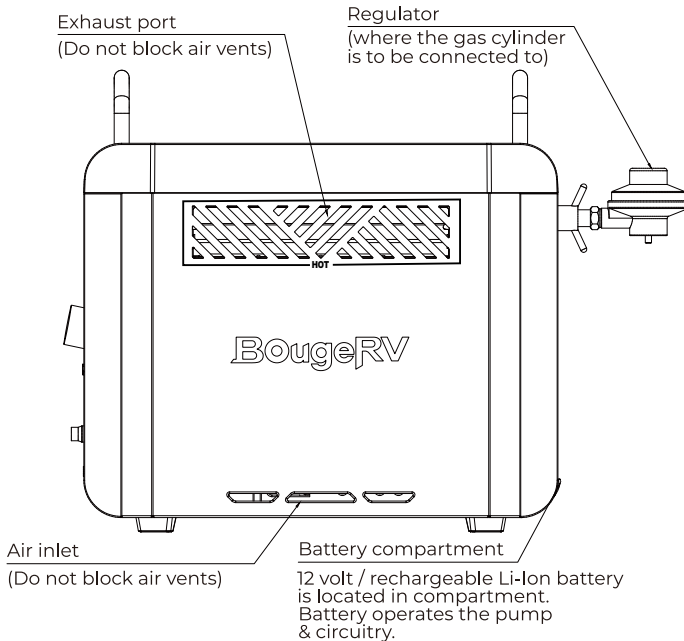
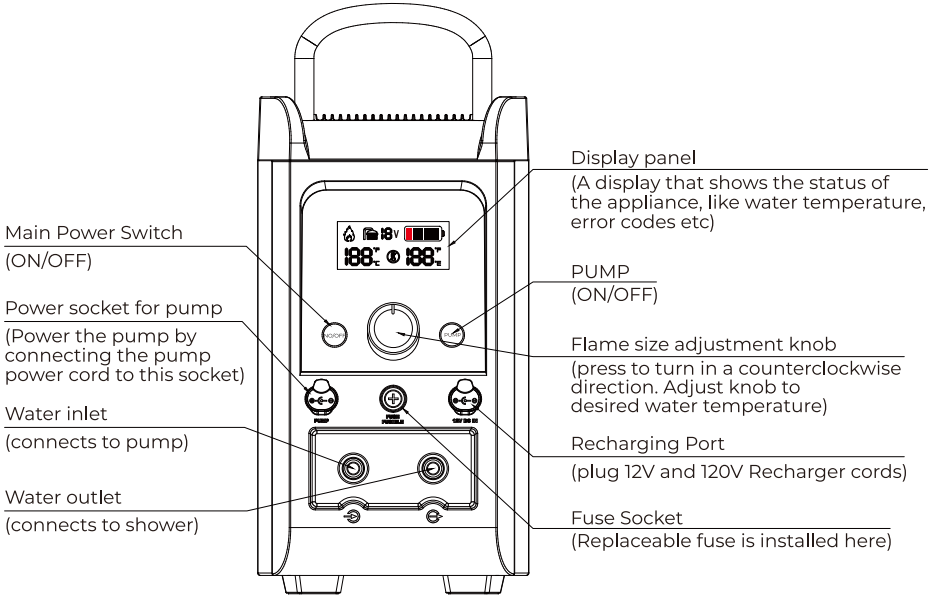

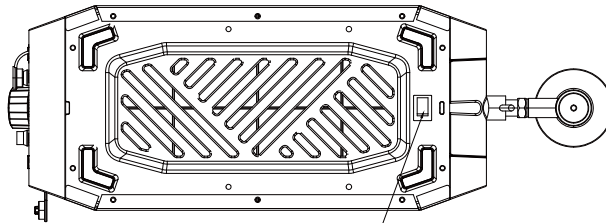
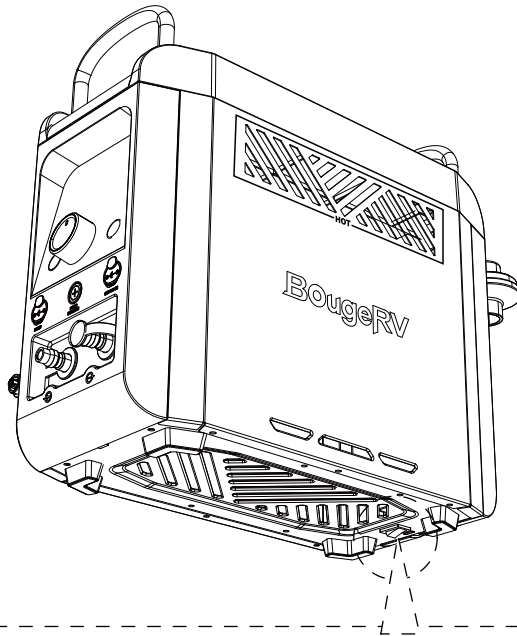

Main Power Switch
(link switch between built-in battery and water heater)

The bottom switch only controls the battery. When the switch is off, if an external power source is connected and the water heater can be used, but there is no way to charge the battery.

Tip: If you do not use the water heater for a long time, you can turn off the switch to protect the battery life.

4. Panel Introduction

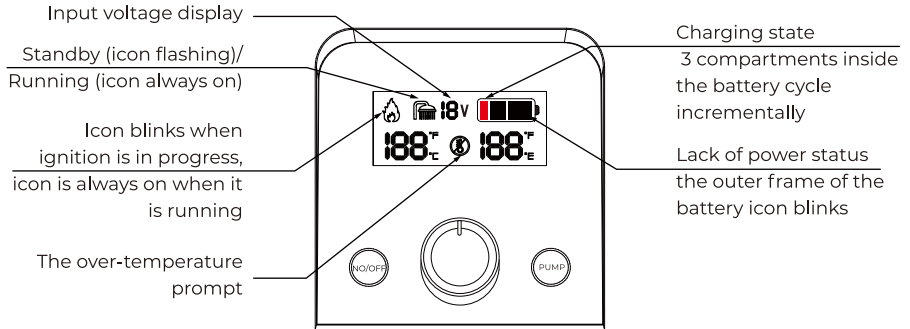

5. Operating Precautions

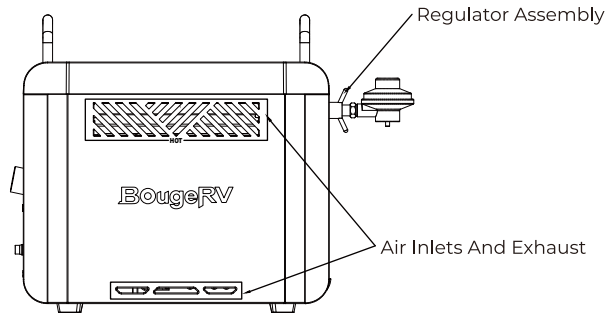

1. During operation, please ensure that all air inlets and exhaust (front, sides and bottom) are kept free from obstructions and closure.
2. Attach the supplied regulator by rotating the t-wing nut in a "clockwise" direction carefully not to over tighten.
Tips: Press the air valve tightly with one hand, and tighten the T-nut with one hand.
3. During set up, check all connections and fittings for leaks using soapy water. Never use a flame to check for leaks, as the leaking gases are flammable and explosive. Please wipe soapy water over all connections and fittings to check for leaks. If the soapy water bubbles, this means that gas is blowing out at that location and a leak has occurred. Check that the connection is not cross threaded and that it is tight. Perform another leak check.
4. If there is still a leak, remove the cylinder and contact the seller directly for service or repair.

6. Product Accessories



Gas Regulator



Auto Recharger Cord
(12 Volt) 5m



Pump Assembly
1.5m



Household Recharger Cord
2.0m



Shower Head Attachment
2.5m

7. Installation & Usage Tutorials

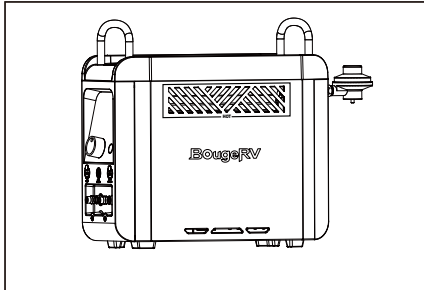

Fig.1

Place the appliance on a solid, non-combustible surface and straighten out all hoses to remove any kinks or twists.

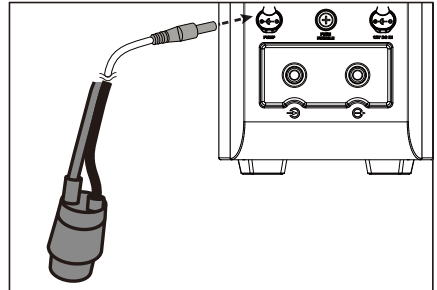

Fig.3

Plug the pump power jack into the pump power socket on the heater.

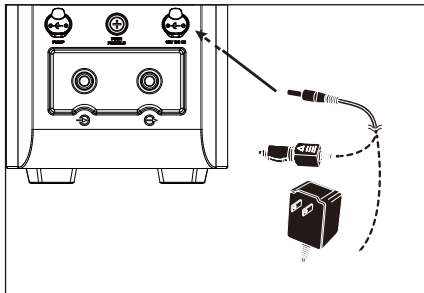

Fig.2

Charge the battery before using the water heater for the first time.

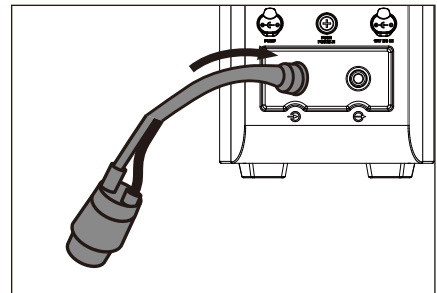

Fig.4

Insert the pump assembly into the water inlet and plug the power cord into the outlet labeled PUMP.

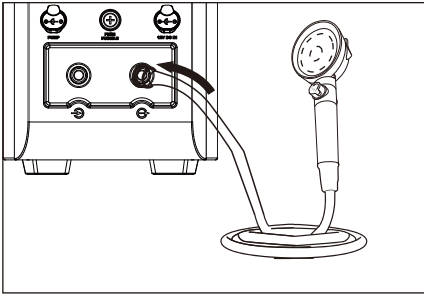

Fig.5

Attach the shower hose using the quick connect fitting, and ensure that the flow switch on the shower head is in the ON position.

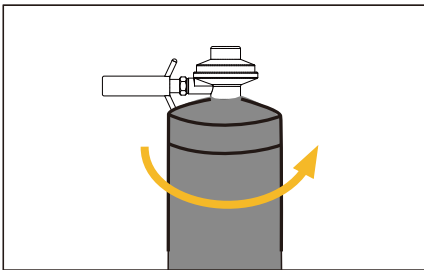

Fig.6

While holding the propane cylinder upright, thread it into The Regulator and tighten correctly.

NOTE: This appliance shall only be used with 1 lb. Propane LPG disposable gas cylinders.

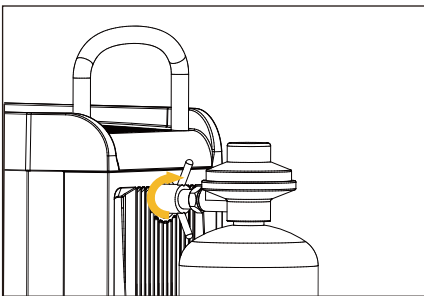

Fig.7

Install the regulator assembly to the appliance. When installing the regulator assembly, push it in slightly and hold so that it can press against the gas inlet connector, then turn the T-nut to tighten it at the same time.

Tips: Press the air valve tightly with one hand, and tighten the T-nut with one hand.

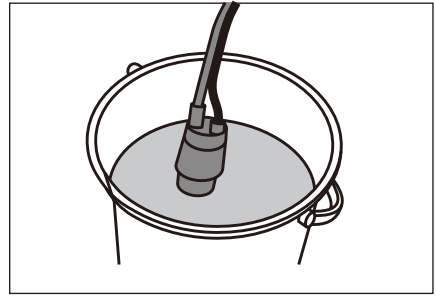

Fig.8

Submerge the pump in a suitable reservoir of water, DO NOT use water directly from rivers, lakes or the ocean. DO NOT use salt water with this appliance.

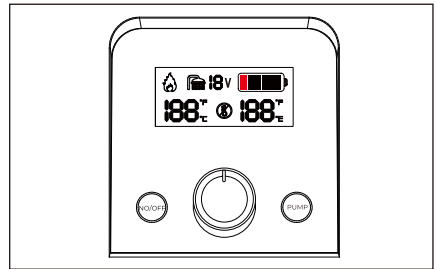

Fig.9

The main power switch "ON/OFF". Start-up feedwater pump "PUMP".

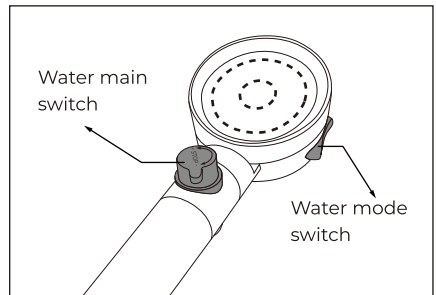

Fig.10

Sliding the flow switch to the ON position, the burner will extinguish and the pump will continue to operate 120s.

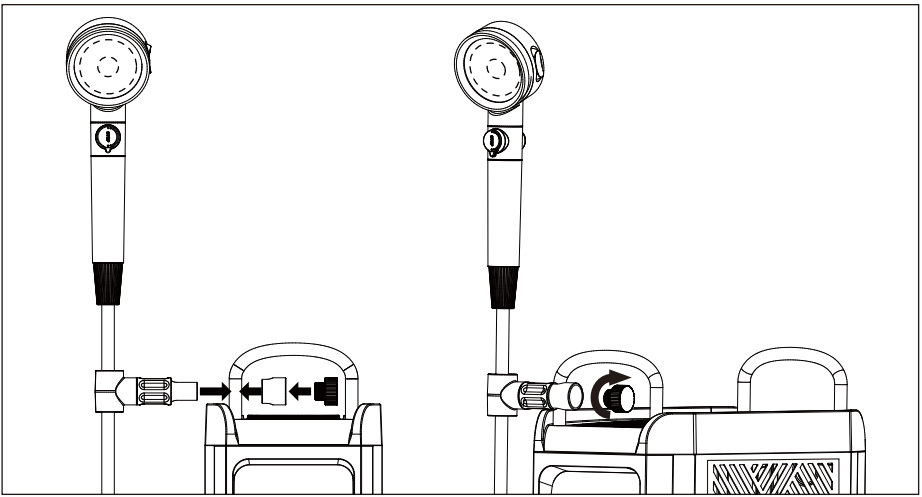

Fig.11

Installation of the shower bracket.

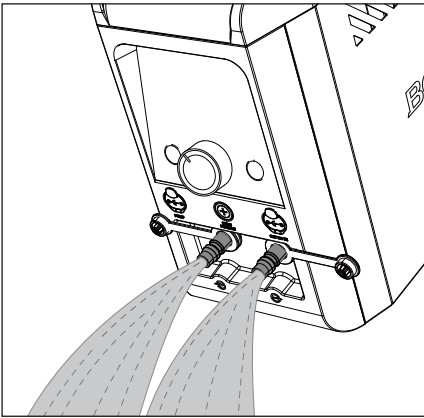

Fig.12

If the machine is not used for a long time, pour out the water inside the machine. Do not store the machine until the water has been poured out.

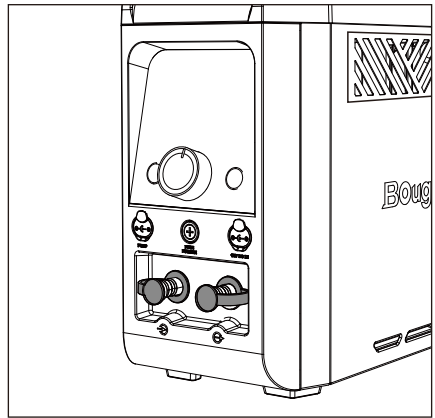

Fig.13

Use two silicone plugs to block the water inlet and outlet holes to prevent water from flowing out during transportation.

About the inlet and outlet water temperature:

This appliance is designed to be used with an inlet water temperature of 68°F or below. This appliance is designed to raise the outlet water temperature by a maximum(average) of 36°F to 54°F above the inlet water temperature and the outlet water temperature can be adjusted by the flame size adjustment knob.

For safety considerations, the appliance is designed to shut off the burner when the outlet water temperature exceeds 122°F+/-3°F(average).

8. Troubleshooting Guide

Symptom	Possible Cause	Solution
Hot water warning	Environment temperature is high	Turn control knob to a cooler setting
	Temperature sensor defective	Contact BougeRV for help
Tilt warning	Heater is tilted more than 30 degrees	Gas & pump will be shut off immediately
	Max. Bottle Pressure	Contact BougeRV for help
Flames out warning	Flames blown out by strong wind / pilot light is out	Do not use in strong wind condition. Turn off the heater completely and restart the ignition sequence
	Flame detection module defective	Contact BougeRV for help
Low battery warning	Battery voltage lower than 9.2V	Recharge the battery
	Defective battery	Contact BougeRV for help
No water source detected	Pump is not in correct position	Put the pump in the water
	Water tank/carrier out no water	Fill water tank/carrier with water
	Pump inlet screen clogged	Clean the pump inlet screen, seen instructions given in maintenance section
	Hose twisted / kinked	Straighten hose
Burner will not light	Battery lead disconnected	Remove battery cover & reinstall lead
	Pump power cord disconnected	Plug cord into power socket on heater
	Low battery	Recharge the battery
	Flow rate sensor defective	Contact BougeRV for help
	Propane cylinder empty	Replace cylinder
	Propane cylinder frosted	Replace cylinder and reuse after thawing
	Fuse defective	Refer to maintenance section and replace the fuse
	Electronic circuit defective	Contact BougeRV for help
Water leakage	Sleeved-connectors were not locked into place	Read instructions for connecting sleeved connectors and reconnect the connectors
	Defective seal or break	Replace sealing components (O-rings) or send to BougeRV when necessary
Battery won't hold a Charge	Defective Battery	reinstall lead
No display	Battery lead disconnected	Remove battery cover & reinstall lead
	Fuse defective	Refer to maintenance section and replace the fuse
	Electronic circuit defective	Contact BougeRV for help
	Low battery	Recharge the battery

9. Error Code Definition

LED DIAGNOSTIC		
Code	Code Definition	Solutions
E0	Inlet Water Temperature Sensor Failure	Restart the appliance one to two times. If it continues to report malfunction, contact BougeRV to resolve the problem.
E1	Flame Sensor Error	
E2	Gas Valve Error	Malfunction reported after turning on, restart the appliance one to two times. If it continues to report malfunction, contact BougeRV to resolve the problem.
E3	Unsuccessful Ignition/Flame Out	<p>Situation 1: Accidental flameout, restart the appliance. Situation 2: Gas pressure too high or too low, cylinder needs to be replaced(must use original regulator and regulator assembly provided by BougeRV). Situation 3: Incorrect gas type, check gas type.</p> <p>If it continues to report malfunction, contact BougeRV to resolve the problem.</p>
E4	Outlet Water Temperature Sensor Failure	Restart the appliance one to two times. If it continues to report malfunction, contact BougeRV to resolve the problem.
E6	Outlet High Water Temperature Protection(122°F, 50°C)	<p>Situation 1: Check if the inlet water temperature is too high. If yes, use the flame size adjustment knob to lower the outlet water temperature setting. Situation 2: Water inlet and outlet flow is too low, clean the shower and clean the pump; Situation 3: Restart the appliance one to two times. If it continues to report malfunction, contact BougeRV to resolve the problem.</p>
E7	The appliance has no water but was burning and keep heating up out of control.	Restart the appliance one to two times. If it continues to report malfunction, contact BougeRV to resolve the problem.
E8	Tilt Protection	<p>Situation 1: The appliance is tilted at an angle greater than 30°. Straighten the appliance and restart it one to two times.</p> <p>If it continues to report malfunction, contact BougeRV to resolve the problem.</p>

10. Circuit Diagram

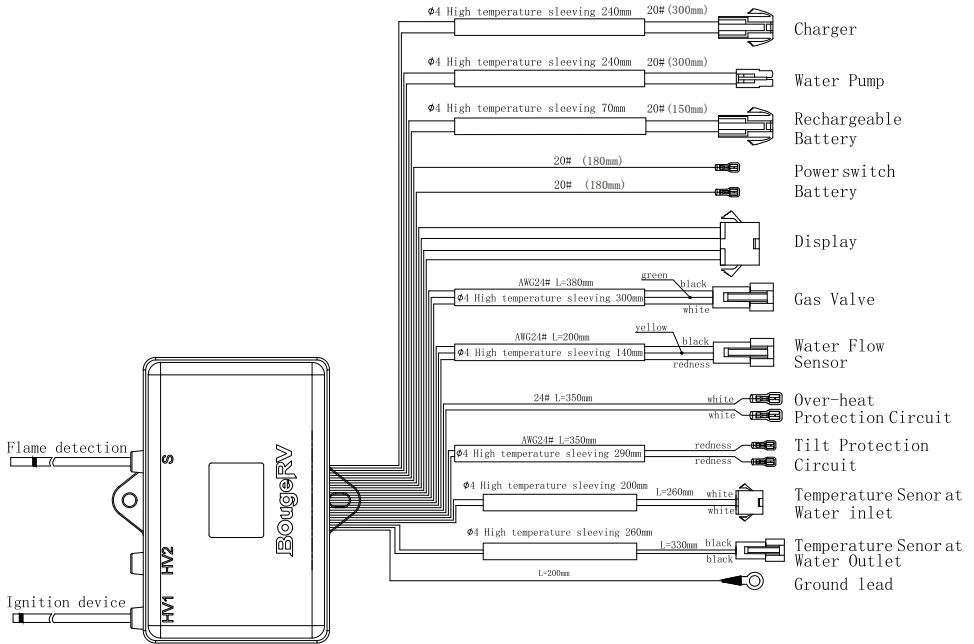

11. Warranty and Maintenance

Warranty

BougeRV Portable Propane Water Heater comes with a 2-year warranty that commences from the date of purchase on BougeRV Amazon Store or BougeRV Official Website, except the following situations:

- Contrived damage.
- Damage caused by force majeure such as earthquake, conflagration, etc.
- Damage from inappropriate use or violating this instruction.
- Damage or malfunction caused by disassembling.

🛡️ 24-month limited warranty

🔧 Lifetime technical support

Customer Service

If there is any problem with the operation or use of the product, please feel free to contact us via:

■ **BougeRV Amazon:** ✉️ service@bouge rv.com

■ **BougeRV Website:** ✉️ support@bouge rv.com

🌐 www.bouge rv.com

☎️ +1 408 656 8402(US)

More service and information:

1. Search "QR Code" on your FB
2. Scan the QR Code beside
3. Join "BougeRV Official Fans Club"



BougeRV Official Fans Club

Explore more from BougeRV



@bouge rv



@Bouge rvofficial



BougeRV

BougeRV