

MPPT Solar Charge Controller

User Manual



Models: MY50
MY60 MY80
MY100

Contents

Important Safety Instructions	1
1 General Information	2
1.1 Overview	2
1.2 Characteristics	3
2 Installation	5
2.1 Attentions	5
2.2 Requirements for the PV array	5
2.3 Wire size	7
2.4 Dry contact instruction	8
2.5 Mounting	9
3 Operation	14
3.1 Indicator	14
3.2 Buttons	14
3.3 LCD Display	15
3.4 Setting	16
4 Others	21
4.1 Protections	21
4.2 Troubleshooting	22
4.3 Maintenance	23
5 Specifications	24
Appendix 1 Dimensions	29

Important Safety Instructions





Please reserve this manual for future review.

This manual contains all safety, installation, and operation instructions for the Tracer-AN series MPPT solar controller ("controller" referred to in this manual).

- Read all the instructions and warnings carefully in the manual before installation.
- No user-serviceable components inside the controller; please do not disassemble or attempt to repair the controller.
- Mount the controller indoors. Avoid exposure to the components and do not allow water to enter the controller.
- Install the controller in a well-ventilated place; the controller's heat sink may become very hot during operation.
- It is suggested to install appropriate external fuses/breakers.
- Make sure to switch off all PV array connections and the battery fuse/breakers before controller installation and adjustment.
- Power connections must remain tight to avoid excessive heating from a loose connection.
- The entire system should be installed by professional and technical personnel.

Explanation of symbols

- To enable users to use the product efficiently and ensure personal and property safety, please read related literature accompanying the following symbols.
- Please read the literature accompanying the following symbols.

Symbol	Definition
TIP	TIP: Indicates any practical advice for reference.
	IMPORTANT: Indicates a critical tip during the operation, if ignored, may cause the device to run in error.
	CAUTION: Indicates potential hazards, if not avoided, may cause the device damaged.
	WARNING: Indicates the danger of electric shock, if not avoided, would cause casualties.
	WARNING HOT SURFACE: Indicates the risk of high temperature, if not avoided, would cause scalds.
	Read the user manual carefully before any operation.

1 General Information

1.1 Overview

Based on multiphase synchronous rectification technology(MSRT) and advanced MPPT control algorithm, adopt dual-core processor and co-negative design, Tracer-AN series controllers own the fast response characteristics, high reliability, and industrial standards. MSRT guarantees a high conversion efficiency in any charging power, which sharply improves the solar system's energy efficiency. The new optimized MPPT tracking technology can fast track the PV array's max power point in any situation and obtains the maximum energy in real-time.

The automatic power reduction function fully ensures access to excess PV modules and high-temperature running.

The Tracer-AN series controller owns a self-adaptive three-stage charging mode based on a digital control circuit. This function can effectively prolong the battery's lifespan and significantly improve the system's performance.

The load/utility/generator dry contact to connect external devices conveniently composes a hybrid power system easily.

Comprehensive electronic protections, including overcharging, over-discharging, and PV reverse polarity protection, effectively ensure a more reliable and durable solar system operation for a longer running time.

The isolated RS485 port with standard MODBUS communication protocol and 5V power supply is easy to expand the application. Up to 6 controllers connected in parallel are supported. The controller can be widely used for various applications, e.g., solar RV, household system and field monitoring, etc.

Features:

- Comply with IEC62109-1 and EN61000-6-1/3 standard certification
- High quality and low failure rate components of ST or IR to ensure the service life
- High tracking efficiency of MPPT no less than 99.5%.
- Maximum DC/DC transfer efficiency is as high as 98.6%*; full load efficiency is up to 98 %*
- Accurate recognizing and tracking technology of multi-peaks maximum power point
- Wider MPP running voltage to increase the PV modules' utilization ratio
- Support the lead-acid and lithium batteries
- Program temperature compensation for batteries.
- Real-time energy statistics function
- High temperature charging automatic power reduction function
- 100% charging and discharging in the working environment temperature range

- Up to 6 controllers connection in parallel to expand the system
- Load dry contact to control the external load switch
- To set the first and the second disconnection voltage of load by the software
- Auto-control of utility and generator dry contact design to compose a hybrid power system easily
- Remote temperature and voltage sensor design to collect more accurate battery temperature/terminal voltage and eliminate the battery cables' voltage drop
- Isolated RS485 communication ports (Modbus protocol)
- 5V/200mA RS485 communication ports with short circuit protection
- Support remote monitoring and parameters setting via the APP or PC software

★ The parameters are measured in the Tracer10415AN@48V system.

1.2 Characteristics

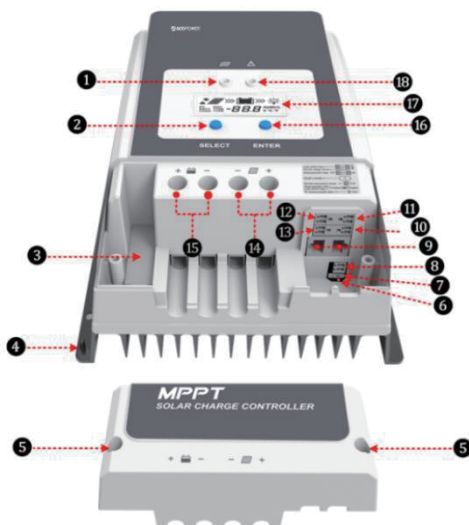



Figure 1 Product Characteristics

① Charging indicator	⑩ (Utility/Generator) dry contact ON interface
② SELECT button	⑪ RBVS interface ⁽⁴⁾
③ External fuse	⑫ (Load) dry contact interface ⁽⁶⁾
④ Grounding terminal	⑬ (Utility/Generator) dry contact OFF interface
⑤ Screw hole(M4)	⑭ PV terminals ⁽⁶⁾
⑥ (PV reverse polarity) alarm indicator	⑮ Battery terminals ⁽⁶⁾

7 (Generator/Load) dry contact enable switch ⁽¹⁾	16 ENTER button
8 RTS interface ⁽²⁾	17 LCD
9 RS485 port(5VDC/200mA) ⁽³⁾	18 Fault indicator

- Set the (Generator/Load) dry contact enable switch **Enabled**  **Disabled** to ON, the (Load) dry contact is enabled; while it is disabled when the switch is set to OFF.
- Connect an RTS (Remote Temperature Sensor) to remotely detect the battery temperature. The sampling distance is no longer than 20m.

 CAUTION	<p>Suppose the temperature sensor is a short circuit or damaged. In that case, the controller can charge or discharge the battery at the default temperature setting of 25 °C(no temperature compensation).</p>
---	---

- When connecting the controller to external devices, only one of the RS485 ports can be used; when connecting multiple controllers in parallel, RS485 ports are for cascaded use.

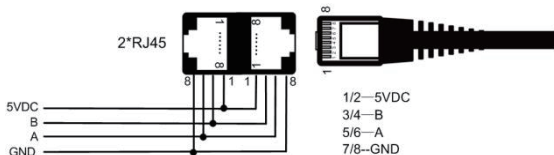

- Connect an RBVS (Remote Battery Voltage Sensor) to detect accurate battery voltage. The sampling distance is no longer than 20m.
- Low Voltage Disconnect Voltage(V_{LVD}) disconnects the dry contact. Low Voltage Reconnect Voltage(V_{LVR}) makes the dry contact connect. When the lithium battery and inverter are used together in the system, connect the controller's (Load) dry contact to the inverter's start-stop dry contact. The controller will manage the inverter's start or stop. If the lithium battery fails, it can protect the controller from being damaged because of the over-current by preventing the controller from directly starting the inverter.
- The controller is designed with a common negative polarity. The negative polarity of the PV and the battery is located on the same busbar.

2 Installation

2.1 Attentions

- Be very careful when installing the batteries. Please wear eye protection when installing the open-type lead-acid battery and rinse with clean water in time for battery acid contact.
- Keep the battery away from any metal objects, which may cause a battery short circuit.
- Acid gas may be generated when the battery is charged. Ensure that the surrounding environment is well ventilated.
- Avoid direct sunlight and rain infiltration when installing it outdoor.
- Loose power connections and corroded wires may result in high heat that can melt wire insulation, burn surrounding materials, or even cause a fire. Ensure tight connections and secure cables with clamps to prevent them from swaying while moving the inverter.
- Only charge the lead-acid and lithium-ion batteries within the control range of this controller.
- The battery connector may be wired to another battery or a bank of batteries. The following instructions refer to a singular battery. Still, it is implied that the battery connection can be made to either one battery or a group of batteries in a battery bank.
- Select the system cables according to 5A/mm² or less current density.

2.2 Requirements for the PV array

(1) Serial connection (string) of PV modules

As the core component of the solar system, the controller needs to suit various PV modules and maximize solar energy conversion into electricity. According to the open-circuit voltage (VOC) and the maximum power point voltage (VMPP) of the MPPT controller, the serial connection of PV modules suitable for different controllers can be calculated. The below table is for reference only.

☒ MY50/MY60/MY80/MY100:

System voltage	36cell Voc< 23V		48cell Voc< 31V		54cell Voc< 34V		60cell Voc< 38V	
	Max.	Best	Max.	Best	Max.	Best	Max.	Best
12V	4	2	2	1	2	1	2	1
24V	6	3	4	2	4	2	3	2
48V	6	5	4	3	4	3	3	3

System voltage	72cell Voc< 46V		96cell Voc< 62V		Thin-Film module Voc> 80V
	Max.	Best	Max.	Best	
12V	2	1	1	1	1

24V	3	2	2	1	1
48V	3	2	2	2	1

 IMPORTANT	The above parameters are calculated under standard test conditions (STC (Standard Test Condition): Module Temperature 25℃, Air Mass1.5, Irradiance 1000W/m2.)
---	---

(2) Max. PV Array Power

This MPPT controller has the function of charging current/power-limiting. During the charging process, when the actual charging current or charging power exceeds the rated charging current or charging power, the controller automatically limits the current or power. It charges the battery as per the rated charging current or charging power. This function can effectively protect the controller's charging modules and prevent damage to the controller due to the over-connected PV array. The actual running status of the PV array is as follows:

Condition 1: Actual PV array's charging power \leq Rated controller's charging power

Condition 2: Actual PV array's charging current \leq Rated controller's charging current

When the controller works under "Condition 1" or "Condition 2," it charges the battery as per the actual charging current or actual charging power. At this time, the controller can work at the maximum power point of the PV array.

 WARNING	When the PV module's power is not greater than the rated charging power, the PV array's maximum open-circuit voltage is more than 100V(Tracer**10AN)/150V(Tracer**15AN)/200V(Tracer**20AN) at the lowest temperature, the controller is damaged.
---	--

Condition 3: Actual PV array's charging power $>$ Rated controller's charging power

Condition 4: Actual PV array's charging current $>$ Rated controller's charging current

When the controller operates under "Condition 3" or "Condition 4," it will carry out the charging as per the rated current or power.

 WARNING	When the PV module's power is greater than the rated charging power, the PV array's maximum open-circuit voltage is more than 100V(Tracer**10AN)/150V(Tracer**15AN)/200V(Tracer**20AN) at the lowest temperature, the controller is damaged.
---	--

According to the "Peak Sun Hours diagram," if the PV array's power exceeds the controller's rated charging power, the charging time as per the rated power is prolonged. The controller can obtain more energy. However, in the practical application, the PV array's maximum power shall be not higher than 1.5 times the controller's rated charging power. Suppose the PV array's maximum power exceeds the controller's rated charging power too much. In that case, it may cause the PV array's waste and increase

the PV array's open-circuit voltage due to the environmental temperature. It may increase the damage probability to the controller. For the recommended maximum power of the PV array, please refer to the table below:

Model	Rated charge current	Rated charge power	Max. PV power	Max. PV open circuit voltage
MY50	50A	625W/12V 1250W/24V 1875W/36V 2500W/48V	937.5W/12V 1875W/24V 2812.5W/36V 3750W/48V	150V(lowest temperature) 138V(25°C)
MY60	60A	750W/12V 1500W/24V 2250W/36V 3000W/48V	1125W/12V 2250W/24V 3375W/36V 4500W/48V	
MY80	80A	1000W/12V 2000W/24V 3000W/36V 4000W/48V	1500W/12V 3000W/24V 4500W/36V 6000W/48V	
MY100	100A	1250W/12V 2500W/24V 3750W/36V 5000W/48V	1875W/12V 3750W/24V 5625W/36V 7500W/48V	

2.3 Wire size

The wiring and installation methods must conform to the national and local electrical code requirements.

PV wire size

The PV array's output current varies with its size, connection method, and sunlight angle. The minimum wire size can be calculated by its ISC(short circuit current). Please refer to the ISC value in the PV module's specifications. When the PV modules are connected in series, the total ISC is equal to any PV module's ISC. When the PV modules are connected in parallel, the total ISC is equal to the sum of all the PV module's ISC. The PV array's ISC must not exceed the controller's maximum PV input current. For max. PV input current and max. PV wire size, please refer to the table as below:

Model	Max. PV input current	Max. PV wire size
MY50	50A	16mm ² /6AWG
MY60	60A	16mm ² /6AWG
MY80	80A	25mm ² /4AWG
MY100	100A	35mm ² /2AWG

**CAUTION**

When the PV modules are connected in series, the total voltage must not exceed the max. PV open circuit voltage
(Tracer**10AN)/138V(Tracer**15AN)/180V(Tracer**20AN)at 25 environment temperature.

 Battery wire size

The battery wire size must conform to the rated current, the reference size as below:

Model	Rated charging current	Battery wire size
MY50	50A	16mm ² /6AWG
MY60	60A	16mm ² /6AWG
MY80	80A	25mm ² /4AWG
MY100	100A	35mm ² /2AWG

**CAUTION**

- The wire size is only for reference. Suppose a long-distance exists between the PV array and the controller or between the controller and the battery. In that case, larger wires shall be used to reduce the voltage drop and improve the system performance.
- The recommended wire for the battery is that its terminals are not connected to any additional inverter.

2.4 Dry contact instruction

Dry contact parameter

Rated Value: 5A/30VDC

Maximum Value: 0.5A/60VDC

1) Control the utility/generator ON/OFF via the (Utility/Generator) dry contact

Utility/Generator start-up Voltage (V_{ON})=Under Voltage Warning Voltage

Utility/Generator stop Voltage (V_{OFF})= Under Voltage Warning Recover Voltage

Battery Voltage (V_{BAT})

+ **Start-up the Utility/Generator:** $V_{BAT} < V_{ON}$.

+ **Stop the Utility/Generator:** $V_{BAT} > V_{OFF}$.

**CAUTION**

- Before start or stop the Utility/Generator via the (Utility/Generator) dry contact, you shall set the switch to the ON position.
- The V_{ON} and V_{OFF} can be set via the PC software. The Battery Control Voltage Parameters refer to chapter [3.4 Setting](#).

2) Control the load first disconnection and second disconnection.

Battery Voltage (V_{BAT})

Under Voltage Warning Voltage (V_{UVW})

Under Voltage Warning Recover Voltage (V_{UVWR})

Low Voltage Disconnect Voltage (V_{LVD})

Low Voltage Reconnect Voltage (V_{LVR})

+ (Utility/Generator) dry contact OFF interface



$V_{BAT} \leq V_{UVW}$: The (Utility/Generator) dry contact OFF interface controls the load ❶ first disconnection.

$V_{BAT} \geq V_{UVWR}$: (Utility/Generator) dry contact OFF interface controls the load ❶ first connection.

+ (Load) dry contact

$V_{BAT} \leq V_{LVD}$: The (Load) dry contact controls the load ❷ second disconnection.

$V_{BAT} \leq V_{LVR}$: The (Load) dry contact controls the load ❷ second connection.

 CAUTION	The Battery Control Voltage Parameters refer to chapter 3.4 Setting .
 WARNING	When the system is power off, the (Utility/Generator) dry contact OFF interface is closed. Please check the system in time.

Refer to below the diagram:

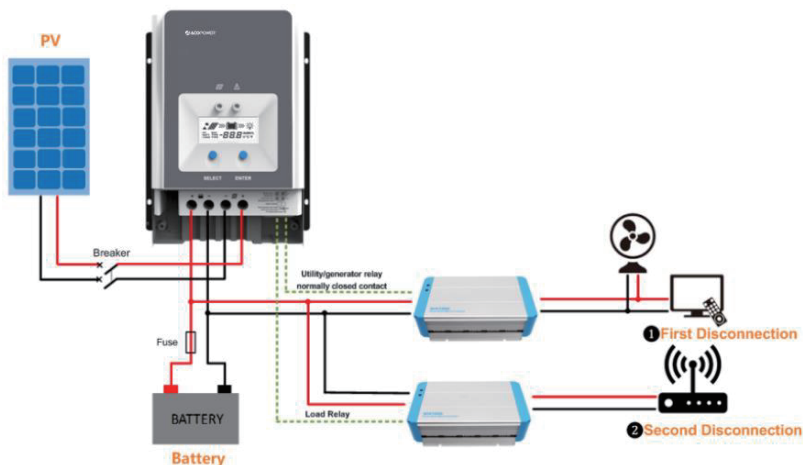

2.5 Mounting

	<ul style="list-style-type: none">• Risk of explosion! Never install the controller in a sealed enclose with flooded batteries! Do not install the controller in a confined area where battery gas can
---	--

<p>WARNING</p>	<p>accumulate.</p> <ul style="list-style-type: none"> • Risk of electric shock! When wiring the solar modules, the PV array can produce a high open-circuit voltage, so turn off the breaker before wiring and be careful when wiring. • Tracer-AN series controllers have no battery reverse protection. Do not reverse the battery during the wiring. Otherwise, the controller may be damaged.
<p> CAUTION</p>	<p>The controller requires at least 150mm of clearance above and below for proper airflow. Ventilation is highly recommended if mounted in an enclosure.</p>

Installation procedures:

Step 1: Determine the installation location and heat-dissipation space

When installing the controller, ensure enough air flowing through the controller's heat sink. Please leave at least 150mm clearance away from the upper and lower edges.

<p> CAUTION</p>	<p>Ventilation is highly recommended if mounted in an enclosure.</p>
---	--

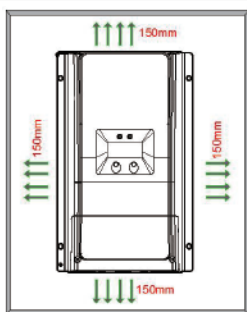
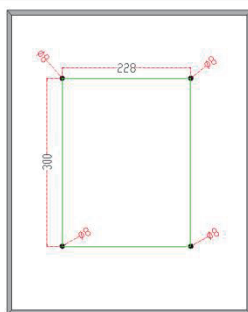

Step2: Remove the terminal protective cover.



※Please remove the terminal protective cover before wiring.

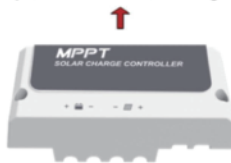

Step 3: Connect the battery (Left) and PV (Right)

<p>! IMPORTANT</p>	<p>Disconnect the system in reverse order.</p>
<p>⚡ WARNING</p>	<p>Tracer-AN series controllers have no battery reverse protection. Do not reverse the battery during the wiring. Otherwise, the controller may be damaged.</p>
<p>⚠ CAUTION</p>	<ul style="list-style-type: none"> • During the wiring, please do not close the circuit breaker or fuse. Ensure that the leads of "+" and "-" poles are polarity correctly. • A fuse whose current is 1.25 to 2 times the controller's rated current must be installed on the battery side with a distance from the battery no longer than 150 mm. • Please connect the inverter directly to the battery, not to the controller's load side. • When the lithium battery and inverter are used together in the system, connect the controller's (Load) dry contact to the inverter's start-stop dry contact.

> Single controller

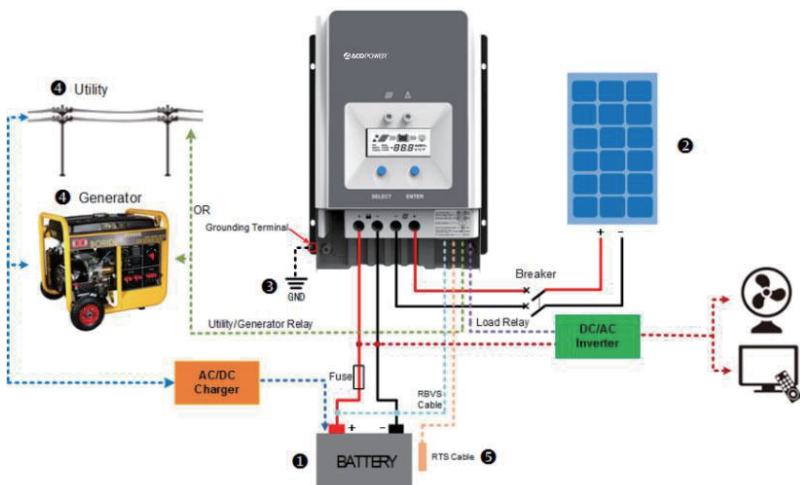

> Connection in parallel

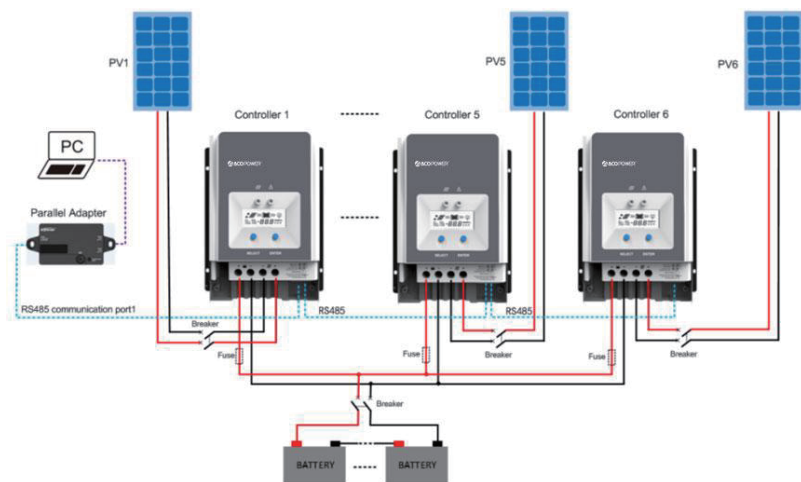

Step 4: Grounding

Tracer-AN series are common-negative controllers. Negative terminals of the PV array, the battery can be grounded simultaneously, or any terminal is grounded. However, according to the practical application, the PV array's negative terminals, battery, and load can also be ungrounded. Simultaneously, the grounding terminal on the shell must be grounded, which effectively shields the electromagnetic interference from the outside and prevents some electric shock to the human body due to the electrification of the shell.



CAUTION

For common-negative systems, such as the RV system, it is recommended to use a common-negative controller. If a common-positive controller is used and the positive electrode is grounded in the common-negative system, the controller may be damaged.

Step 5: Connect accessories

- **Connect the remote temperature sensor cable (Model: RTS300R47K3.81A)**

Connect the remote temperature sensor cable to the interface ③ and place the other end close to the battery.

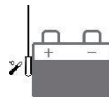

CAUTION

Suppose the remote temperature sensor is not connected to the controller. In that case, the controller can charge or discharge the battery at the default 25 °C (no temperature compensation).

- **Connect the remote battery voltage sensor cable (Model: RVBS300B3.81)**

Connect the remote battery voltage sensor cable to the interface ① and connect the other end to the

battery terminals.

- **Connect the accessories for RS485 communication; refer to the *accessories list*.**

Step 6: Power on the controller

Close the battery's fuse to power on the controller. After the LCD normally displays, close the PV array's circuit breaker. The charging indicator is slow flashing during the PV charging process.



CAUTION

If the controller can not work properly or the fault indicator shows an abnormality, please refer to [4.2 "Troubleshooting"](#).

3 Operation



3.1 Indicator

Indicator	Color	Status	Instruction
	Green	ON solid	PV connection is normal, but the voltage is low and not charging.
	Green	OFF	No PV voltage(night time) or PV connection fault
	Green	Slowly flashing(1Hz)	PV is charging
	Green	Fast flashing(4Hz)	PV over voltage



IMPORTANT: The fault indicator refers to chapter 3.3, "[LCD Display.](#)"

3.2 Buttons

Modes	Note
(Load) dry contact	In manual mode, short press the "ENTER" button to turn on/off the (Load) dry contact.
Clear fault	Press the "ENTER" button
Browsing mode	Short press the "SELECT" button
Setting mode	Long-press the "ENTER" button to enter the Setting mode, and short press the "SELECT" button to modify the parameter. Then short press the "ENTER" button to confirm or exit the current interface automatically after more than 10S.

3.3 LCD Display

1) Status Description

Name	Symbol	Status
PV array		Day
		Night
		No charge
		Charging
	PV	PV array's voltage, current, and generate energy
Battery		Battery capacity, In Charging
	BATT.	Battery Voltage, Current, Temperature
	BATT. TYPE	Battery type
Load		(Load) dry contact connected
		(Load) dry contact disconnected



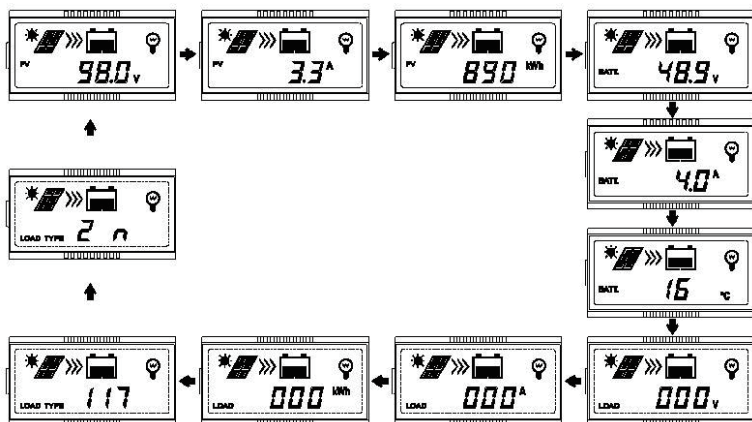

2) Browse interface



IMPORTANT

When no operation, the display interface will be an automatic cycle except for the load time1 and load time 2 interface.

3) Error codes

Status	Faults Indicator	Charging indicator	Symbol	Instruction
Battery over discharged	Red ON solid	--		Battery level shows empty, battery frame blink, fault icon blink.
Battery over voltage	Red Slow flashing	--		Battery level shows full, battery frame blink, fault icon blink.
Battery over heating	Red slowly flashing	--		Battery level shows current value, battery frame blink, fault icon blink.
Controller over temperature	Red slowly flashing	Green slowly flashing		Battery level shows current value, battery frame blink, fault icon blink.
System voltage error	Red slowly flashing	Fast flashing in green		Battery level shows current value, battery frame blink, fault icon blink.

3.4 Setting

1) Clear the generated energy

In the PV power interface, long press the "ENTER" button until the value flashes. Then it enters the reset mode; press the "ENTER" button again to confirm and reset.

2) Switch the battery temperature unit

In the battery temperature interface, long press the "ENTER" button to switch the unit.

3) Battery type

① Support battery types

Lead-acid battery	Sealed(default)
	Gel
	Flooded
	User
Lithium battery	LiFePO4(4S/12V;8S/24V;16S/48V)
	Li(NiCoMn)O2 (3S/12V;6S/24V;12S/48V)
	User

② Setting the battery type via the LCD

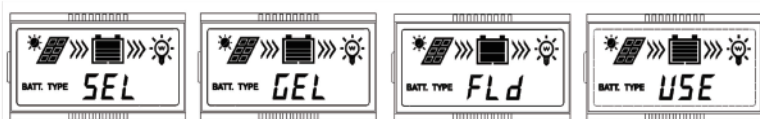

① Sealed (Default)

② Gel

③ Flooded

④ User (Apply to "MT50" and "PC software "Solar Station Monitor")

Operation:

On the battery voltage interface, long press the "ENTER" button until the battery type interface flashes. Then press the "SELECT" button to change the battery type, and press the "ENTER" button to confirm.



CAUTION

The controller can only set the lead-acid battery type. The lithium battery type needs to be set through the PC software or APP.

③ Setting the battery type via the PC software or APP software

● PC software

Connect the controller and the PC through the USB to the RS485 converter, and set the controller's parameters through the PC software. Please refer to the *cloud platform manual* for the specific setting.

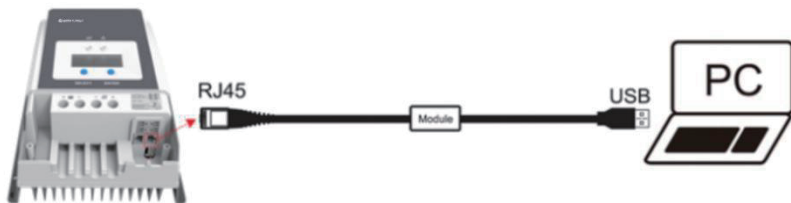

● APP software

Connect the controller and the WIFI module or Bluetooth module through a standard network cable (parallel cable). The mobile phone APP sets the controller's parameters through the WIFI signal or the Bluetooth signal. For the specific setting, please refer to the *cloud APP manual*.

W

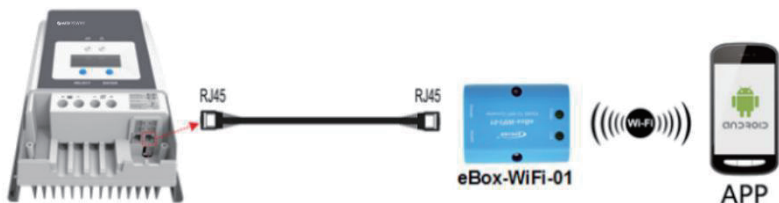

 CAUTION	<p>The controller can only set the lead-acid battery type. The lithium battery type needs to be set through the PC software or APP.</p>
---	---

④ Battery voltage control parameters

◆ Lead-acid battery parameters

The parameters are measured in the condition of 12V/25 °C. Please double the values in the 24V system and quadruple the values in the 48V system.

Voltage control parameters	Sealed	GEL	FLD	User
Over voltage disconnect voltage	16.0V	16.0V	16.0V	9~17V
Charging limit voltage	15.0V	15.0V	15.0V	9~17V
Over voltage reconnect voltage	15.0V	15.0V	15.0V	9~17V
Equalize charging voltage	14.6V	--	14.8V	9~17V
Boost charging voltage	14.4V	14.2V	14.6V	9~17V
Float charging voltage	13.8V	13.8V	13.8V	9~17V
Boost reconnect charging voltage	13.2V	13.2V	13.2V	9~17V
Low voltage reconnect voltage	12.6V	12.6V	12.6V	9~17V
Under voltage warning reconnect voltage	12.2V	12.2V	12.2V	9~17V
Under voltage warning voltage	12.0V	12.0V	12.0V	9~17V
Low voltage disconnect voltage	11.1V	11.1V	11.1V	9~17V
Discharging limit voltage	10.6V	10.6V	10.6V	9~17V
Equalize Duration	120 minutes	--	120 minutes	0~180 minutes
Boost Duration	120 minutes	120 minutes	120 minutes	10~180 minutes

(1) To change these parameters, select "User" battery type.

(2) The following rules must be observed when modifying the parameter's value in user battery type (factory default value is the same as sealed type):

- A. Over Voltage Disconnect Voltage > Charging Limit Voltage ≥ Equalize Charging Voltage ≥ Boost Charging Voltage ≥ Float Charging Voltage > Boost Reconnect Charging Voltage.
- B. Over Voltage Disconnect Voltage > Over Voltage Reconnect Voltage
- C. Low Voltage Reconnect Voltage > Low Voltage Disconnect Voltage ≥ Discharging Limit Voltage.
- D. Under Voltage Warning Reconnect Voltage > Under Voltage Warning Voltage ≥ Discharging Limit Voltage;
- E. Boost Reconnect Charging voltage > Low Voltage Reconnect Voltage.

◆ **Lithium battery parameters**

The parameters are measured in the condition of 12V/25 °C. Please double the values in the 24V system and quadruple the values in the 48V system.

Battery type	LFP	Li(NiCoMn)O2	User
Voltage control parameters			
Over voltage disconnect voltage	15.6V	13.5V	9~17V
Charging limit voltage	14.6V	12.6V	9~17V
Over voltage reconnect voltage	14.7V	12.7V	9~17V
Equalize charging voltage	14.5V	12.5V	9~17V
Boost charging voltage	14.5V	12.5V	9~17V
Float charging voltage	13.8V	12.2V	9~17V
Boost reconnect charging voltage	13.2V	12.1V	9~17V
Low voltage reconnect voltage	12.8V	10.5V	9~17V
Under voltage warning reconnect voltage	12.8V	11.0V	9~17V
Under voltage warning voltage	12.0V	10.5V	9~17V
Low voltage disconnect voltage	11.1V	9.3V	9~17V
Discharging limit voltage	10.6V	9.3V	9~17V

• **The following rules must be observed when modifying the parameter values in User for a lithium battery.**

- A. Over Voltage Disconnect Voltage > Over Charging Protection Voltage (Protection Circuit Modules (BMS)) + 0.2V;
- B. Over Voltage Disconnect Voltage > Over Voltage Reconnect Voltage = Charging Limit Voltage ≥ Equalize Charging Voltage = Boost Charging Voltage ≥ Float Charging Voltage > Boost Reconnect Charging Voltage;
- C. Low Voltage Reconnect Voltage > Low Voltage Disconnect Voltage ≥ Discharging Limit Voltage.
- D. Under Voltage Warning Reconnect Voltage > Under Voltage Warning Voltage ≥ Discharging Limit

Voltage;

E. Boost Reconnect Charging voltage > Low Voltage Reconnect Voltage;

F. Low Voltage Disconnect Voltage \geq Over Discharging Protection Voltage (BMS)+0.2V







WARNING

- The voltage parameters of a lithium battery can be set according to the lithium battery BMS's voltage parameters.
- The required accuracy of BMS shall be no higher than 0.2V. We will not assume any responsibility for the system abnormal when the accuracy of BMS is higher than 0.2 v.

4 Others

4.1 Protections

 WARNING	Tracer AN series controllers have no battery reverse protection. Do not reverse the battery during the wiring. Otherwise, the controller may be damaged.
---	--

Protections	Instruction
PV current/power-limiting protection	When the PV array's actual charging current or power exceeds the controller's rated charging current or power, the controller charges the battery as per the rated current or power.
PV short-circuit protection	When not in the PV charging state, the controller will not be damaged in the case of short-circuiting in the PV array.  WARNING: It is forbidden to short-circuit the PV array during charging. Otherwise, the controller may be damaged.
PV reverse polarity protection	When the PV array's polarity is reversed, the controller may not be damaged and resume work after the mis-wiring is corrected.  CAUTION: If the PV array is reversed and its actual power is 1.5 times the controller's rated power, the controller may be damaged.
Night reverse charging protection	Prevent the battery from discharging to the PV module at night.
Battery over voltage protection	When the battery voltage reaches the over voltage disconnect voltage, the PV array will automatically stop charging the battery to prevent the battery damage caused by overcharging.
Battery over discharging protection	When the battery voltage reaches the low voltage disconnect voltage, the battery discharging is automatically stopped to prevent battery damage caused by over discharging.  CAUTION: When a load is connected to the battery and the load is connected to the controller's (Load) dry contact, the battery over-discharge protection takes effect.
Battery over heating protection	The controller detects the battery temperature through an external temperature sensor. The battery stops working when its temperature exceeds 65°C and resumes work when its temperature is below 55°C.
Lithium battery low	When the temperature detected by the optional temperature sensor is

temperature protection	lower than the Low Temperature Protection Threshold(LTPT), the controller stops charging and discharging automatically. When the detected temperature is higher than the LTPT, the controller resumes work automatically. (The LTPT is 0 °C by default and can be set within the range of 10 ~ -40 °C. Detail settings refer to the LTPT V1.0.)
Controller Overheating★	An internal temperature sensor can detect the internal temperature of the controller. The controller stops working when the internal temperature exceeds 85 °C and resumes work when the internal temperature is below 75°C.
TVS high voltage transients protection	The controller's internal circuitry is designed with Transient Voltage Suppressors (TVS), which can only protect against high-voltage surge pulses with less energy. Suppose the controller is to be used in an area with frequent lightning strikes. In that case, it is recommended to install an external surge arrester.

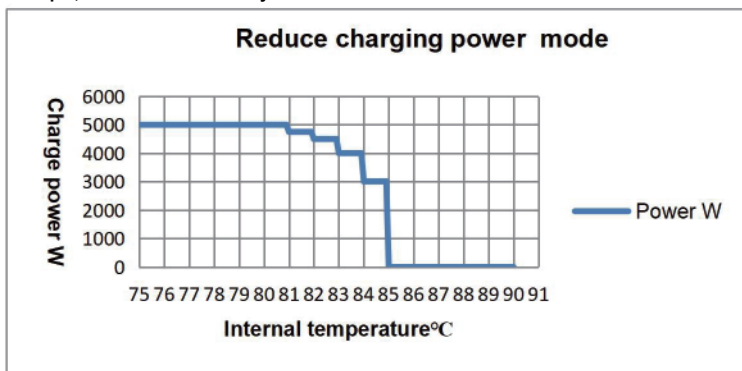

★ When the control's internal temperature is 81°C, the reducing power charging mode is turned on, reducing the charging power of 5%,10%,20%,40% every increase of 1 °C. If the internal temperature is greater than 85°C, the controller stops charging. When the internal temperature is not more than 75°C, the controller will resume charge as per the rated power.

For example, Tracer10420AN 48V system:



4.2 Troubleshooting

Faults	Faults	Solutions
Charging LED is OFF during daytime when sunshine falls on PV array properly	PV array open-circuit	Confirm whether the connection of the PV array is correct and tight

The wire connection is correct; the controller is not working.		The battery voltage is lower than 8V.	Please check the voltage of the battery(at least 8V voltage to activate the controller).
Battery frame blink, fault icon blink		Battery over voltage	Check whether the battery voltage is higher than OVD (over voltage disconnect voltage) and disconnect the PV array connection.
		Battery over discharged	① When the battery voltage is restored to or above LVR(low voltage reconnect voltage), the load recovers. ② Other ways to recharge the battery.
		Battery over heating	While the battery temperature decline to 55 °C or below, the controller resumes work.

4.3 Maintenance

The following inspections and maintenance tasks are recommended at least two times per year for the best performance.

- Make sure no block on airflow around the controller. Clear up any dirt and fragments on the radiator.
- Check all the naked wires to ensure insulation is not damaged for sun exposure, frictional wear, dryness, insects or rats, etc. Repair or replace some wires if necessary.
- Check and confirm that LED is consistent with required. Pay attention to any troubleshooting or error indication. Take necessary corrective action.
- Confirm that all terminals have no corrosion, insulation damaged, high temperature, or burnt/discolored sign, and tighten terminal screws to the suggested torque.
- Clear up dirt, nesting insects, and corrosion in time.
- Check and confirm that the lightning arrester is in good condition. Replace a new one in time to avoid damaging the controller and even other equipment.

 WARNING	<p>Risk of electric shock!</p> <p>Ensure that all the power is turned off before the above operations, and then follow the corresponding inspections and operations.</p>
---	--

5 Specifications

Model	MY50	
Electrical Parameters		
System rated voltage	12/24/36/48VDC or Auto	
Controller working voltage range	8V~68V	
Lead-acid battery type	Sealed(Default)/Gel/Flooded/User	
Lithium battery type	LiFePO4/ Li(NiCoMn)O2/ User	
Battery fuse	80A/ 58V	
Rated charging current	50A	
Rated charging power	625W/12V, 1250W/24V, 1875W/36V, 2500W/48V	
Max. PV open-circuit voltage	150V(at the lowest temperature) 138V(25°C)	
MPPT voltage range	(Battery voltage +2V) ~108V(25°C)	(Battery voltage +2V) ~ 144V(at 25°C)
MPPT tracking efficiency	≥99.5%	
Max. conversion efficiency	98.3%	
Full load efficiency	97.8%	97.1%
Temperature compensate coefficient	-3mV/°C/2V(Default)	
Self-consumption	98mA/12V; 60mA/24V; 50mA/36V; 46mA/48V	
Grounding	Common negative grounding	
Dry contact	Rated value: 5A/30VDC; Max. value: 0.5A/60VDC	
Communication method	RS485(5VDC/200mA, Two RJ45 ports in parallel) ^①	
LCD backlight time	Default: 60S, Range:0~999S (0S: the backlight is ON all the time)	
Mechanical parameters		
Dimension	261×216×119mm	
Mounting dimension	180×204mm	
Mounting hole size	Φ7	
Wire size	6AWG/ 16mm ²	
Recommended cable	6AWG/ 16mm ²	
Net Weight	3.5kg	

① When connecting the controller to external devices, only one of the communication ports is used; when connecting multiple controllers in parallel, RS485 ports are for cascaded use.

Model	MY60
-------	------

Electrical Parameters	
System rated voltage	12/24/36/48VDC or Auto
Controller working voltage range	8V~32V
Lead-acid battery type	Sealed(default), GEL, FLD, and user-defined.
Lithium battery type	LiFePO4/ Li(NiCoMn)O2/ User
Battery fuse	80A/ 58V
Rated charging current	60A
Rated charging power	750W/12V, 1500W/24V
Max. PV open-circuit voltage	150V(at the lowest temperature) 92V(at 25°C)
MPPT voltage range	(Battery voltage +2V) ~72V(at 25°C)
MPPT tracking efficiency	≥99.5%
Max. conversion efficiency	98.0%
Full load efficiency	97.0%
Temperature compensate coefficient	-3mV/°C/2V(Default)
Self-consumption	98mA/12V; 60mA/24V; 50mA/36V; 46mA/48V
Grounding type	Common negative grounding
Dry contact	Rated value: 5A/30VDC; Max. value: 0.5A/60VDC
Communication method	RS485(5VDC/200mA, Two RJ45 ports in parallel) ^①
LCD backlight time	Default: 60S, Range:0~999S (0S: the backlight is ON all the time)
Mechanical parameters	
Dimension	340×232×105.2mm
Mounting dimension	260×220mm
Mounting hole size	Φ7
Wire size	2AWG/ 35mm ²
Recommended cable	6AWG/ 16mm ²
Net Weight	3.5kg

① When connecting the controller to external devices, only one of the communication ports is used; when connecting multiple controllers in parallel, RS485 ports are for cascaded use.

Model	MY80
Electrical Parameters	
System rated voltage	12/24/36/48VDC or Auto

Controller working voltage range	8V~68V	
Lead-acid battery type	Sealed(Default)/Gel/Flooded/User	
Lithium battery type	LiFePO4/ Li(NiCoMn)O2/ User	
Battery fuse	125A/ 58V	
Rated charging current	80A	
Rated charging power	1000W/12V, 2000W/24V, 3000W/36V, 4000W/48V	
Max. PV open-circuit voltage	150V(at the lowest temperature) 138V(at 25°C)	
MPPT voltage range	(Battery voltage +2V) ~ 108V(at 25°C)	(Battery voltage +2V) ~ 144V(at 25°C)
MPPT tracking efficiency	≥99.5%	
Max. conversion efficiency	98.5%	
Full load efficiency	98.0%	97.5%
Temperature compensate coefficient	-3mV/°C/2V(Default)	
Self-consumption	98mA/12V; 60mA/24V; 50mA/36V; 46mA/48V	
Grounding type	Common negative grounding	
Dry contact	Rated value: 5A/30VDC; Max. value: 0.5A/60VDC	
Communication method	RS485(5VDC/200mA, Two RJ45 ports in parallel) ^①	
LCD backlight time	Default: 60S, Range:0~999S (0S: the backlight is ON all the time)	
Mechanical parameters		
Dimension	394×240×134mm	
Mounting dimension	300×228mm	
Mounting hole size	Φ7	
Wire size	2AWG/ 35mm ²	
Recommended cable	4AWG/ 25mm ²	
Net Weight	6.1kg	

① When connecting the controller to external devices, only one of the communication ports is used; when connecting multiple controllers in parallel, RS485 ports are for cascaded use.

Model	MY100	
Electrical Parameters		
System rated voltage	12/24/36/48VDC or Auto	
Controller working voltage range	8V~68V	
Lead-acid battery type	Sealed(Default)/Gel/Flooded/User	
Lithium battery type	LiFePO4/ Li(NiCoMn)O2/ User	
Battery fuse	150A/ 58V	

Rated charging current	100A	
Rated charging power	1250W/12V, 2500W/24V, 3750W/36V, 5000W/48V	
Max. PV open-circuit voltage	150V(at the lowest temperature) 138V(at 25°C)	
MPPT voltage range	(Battery voltage +2V) ~ 108V(at 25°C)	(Battery voltage +2V) ~ 144V(at 25°C)
MPPT tracking efficiency	≥99.5%	
Max. conversion efficiency	98.6%	98.5%
Full load efficiency	98.0%	97.6%
Temperature compensate coefficient	-3mV/°C/2V(Default)	
Self-consumption	98mA/12V; 60mA/24V; 50mA/36V; 46mA/48V	
Grounding type	Common negative grounding	
Dry contact	Rated value: 5A/30VDC; Max. value: 0.5A/60VDC	
Communication method	RS485(5VDC/200mA, Two RJ45 ports in parallel) ^①	
LCD backlight time	Default: 60S, Range:0~999S (0S: the backlight is ON all the time)	
Mechanical parameters		
Dimension	394×242×143mm	
Mounting dimension	300×230mm	
Mounting hole size	Φ7	
Wire size	2AWG/ 35mm ²	
Recommended cable	2AWG/ 35mm ²	
Net Weight	7.4kg	

① When connecting the controller to external devices, only one of the communication ports is used; when connecting multiple controllers in parallel, RS485 ports are for cascaded use.

Environmental Parameters

Working environment temperature	-25°C~+60°C (when the working temperature reaches 45°C or above, the charging power and load power will be reduced appropriately; working of full load is not supported.)
LCD temperature range	-20°C~+70°C
Storage temperature	-30°C~+85°C
Relative humidity range	5%~95% (N.C.)
Enclosure	IP20
Pollution degree	PD2

Certification:

Category	Standard
----------	----------

Safety	EN/IEC62109-1
EMC	EN61000-6-1/EN61000-6-3
FCC	47 CFR Part 15, Subpart B
ROHS	IEC62321-3-1

Appendix 1 Dimensions

(Unit: mm)

☒ MY50

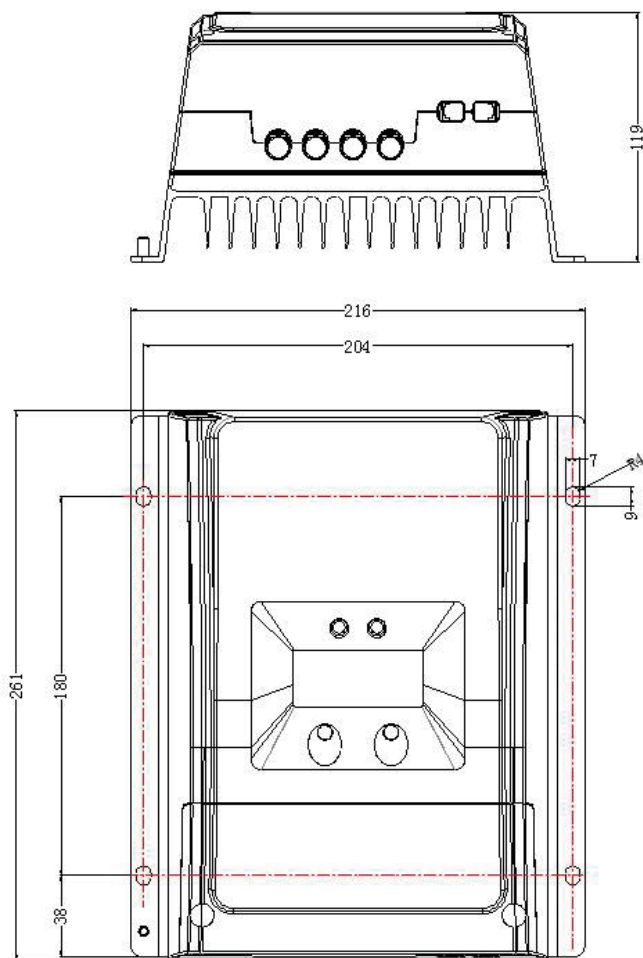

MY60

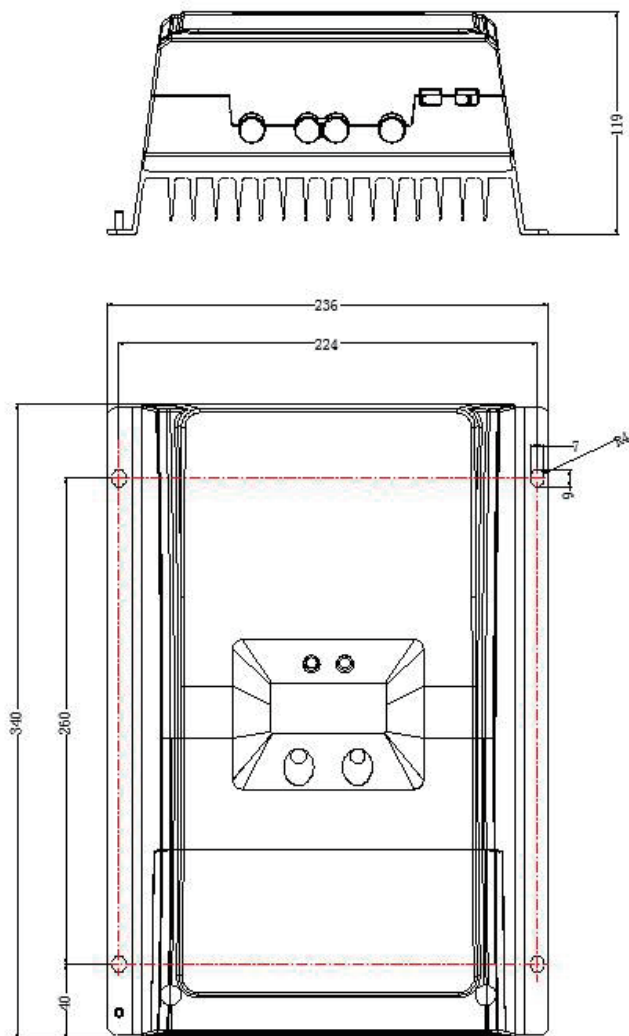

☒ MY80

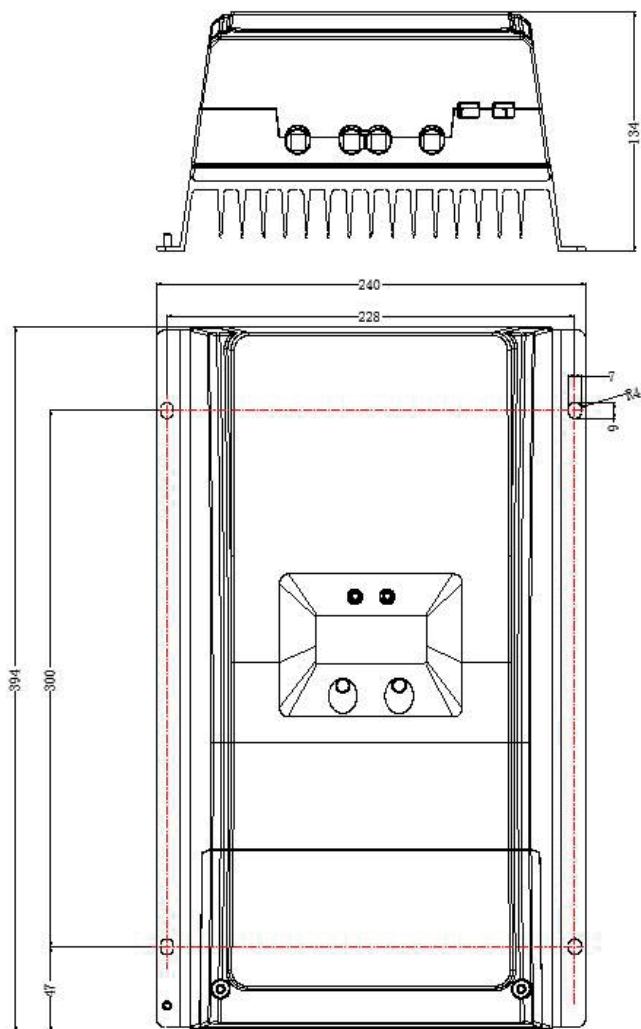

☒ MY100

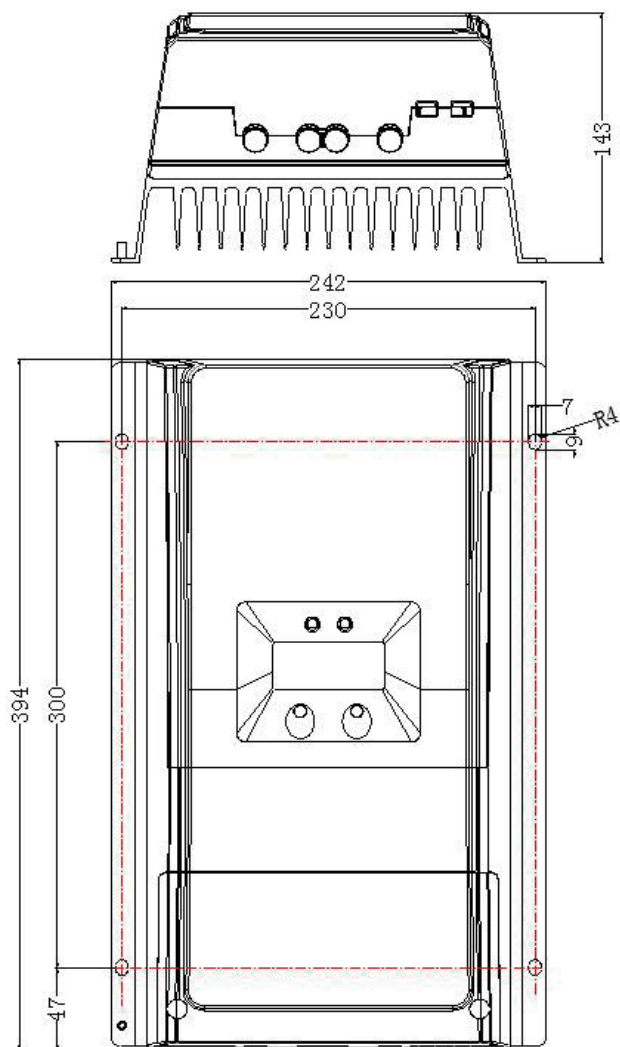

Any changes without prior notice! Version number: V3



Tel: +1- (626) 575-7722

E-mail: Sales@ACOPower.com

Website: <http://www.acopower.com>

Add: 4120 Valley Blvd, Walnut, CA 91789, USA